

This drawing is confidential and must not be reproduced or used without the consent of EXM

Ce dessin est confidentiel et ne doit pas être reproduit ou utilisé sans le consentement de EXM

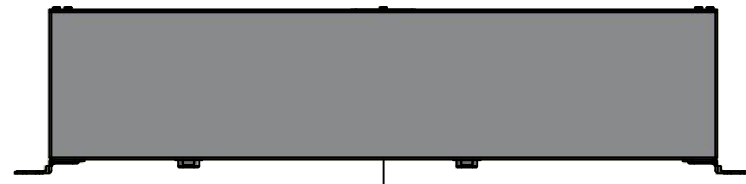

TOP

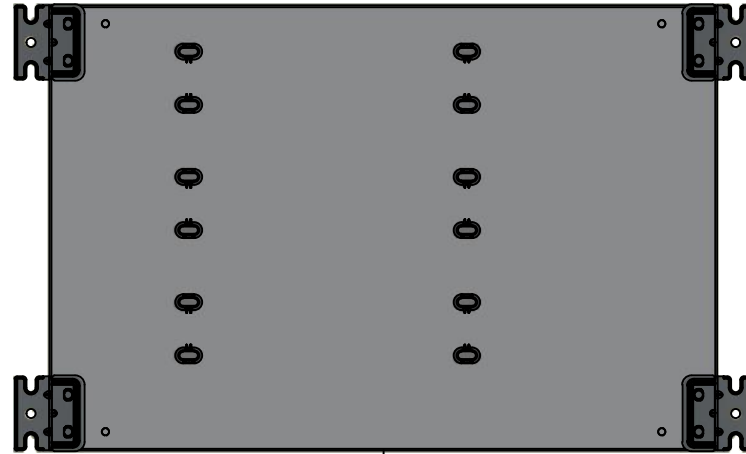

BACK



BOTTOM

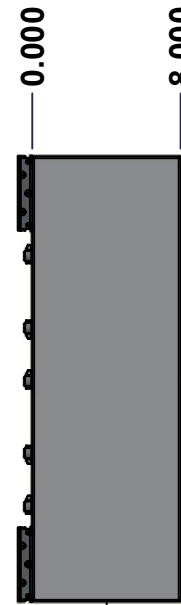

LEFT

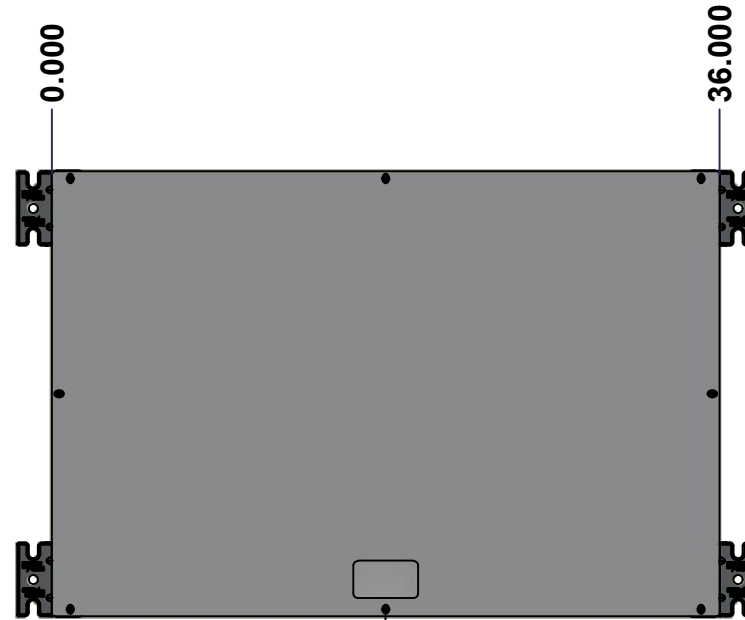

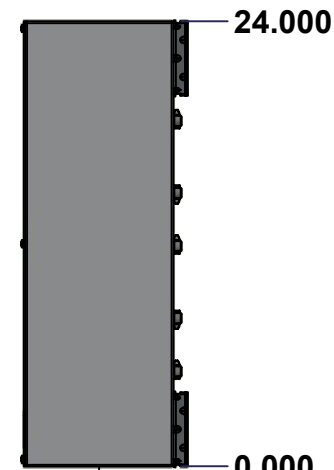

FRONT

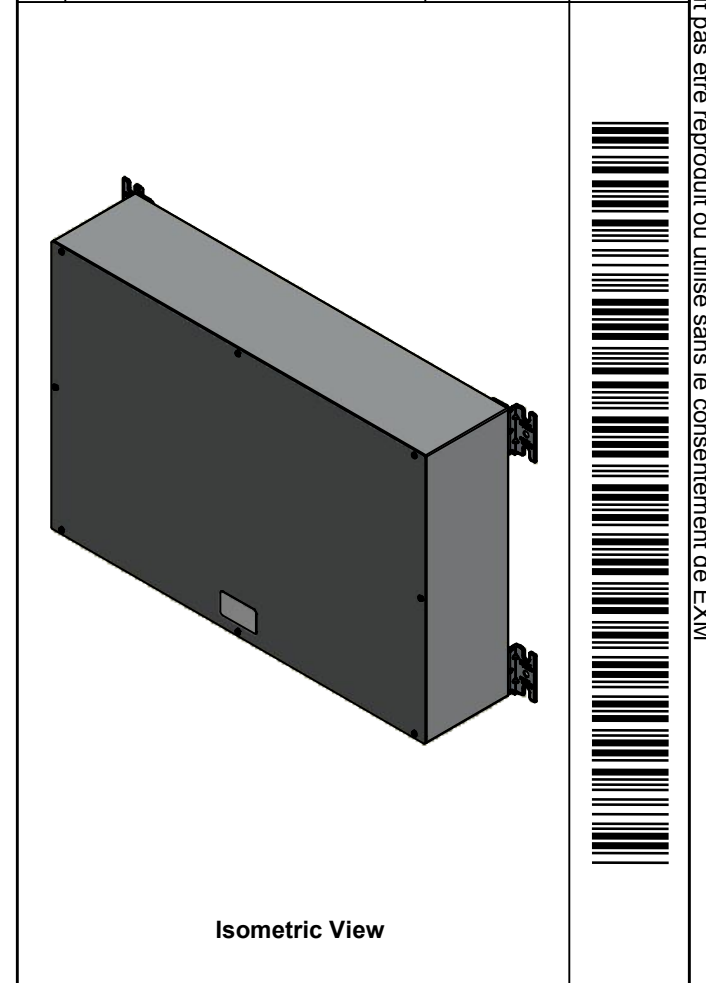

RIGHT

No.	Revisions	Date	By/Par



 Tél: (450) 979-4373 Fax: (450) 979-4626 <a href="http://www.exmweb.com">www.exmweb.com</a>		Flatness Aplatissement	
		Max 3.0mm	
Customer Client		Date	
Drawn By Dessiné Par BoxCad: BoxCad		Date 25-Jul-22	
Material Matière 14 Ga Cold Rolled A1008 CS Type B (1.7mm)			
Color Couleur Asa-61 Grey		Finish Fini Smooth	
Description 1100BT 600A - 3Wires x 36" Assembly			Detail Rev.
Part Number Numéro Pièce <b>1100BT03603</b>		Rev. <b>0</b>	1 8

SEE BILL OF MATERIAL ON LAST PAGE

This drawing is confidential and must not be reproduced or used without the consent of Eurobox

Ce dessin est confidentiel et ne doit pas être reproduit ou utilisé sans le consentement de Eurobox

**STANDARD FEATURES ARE NOT LISTED IN THIS HOLE TABLE**

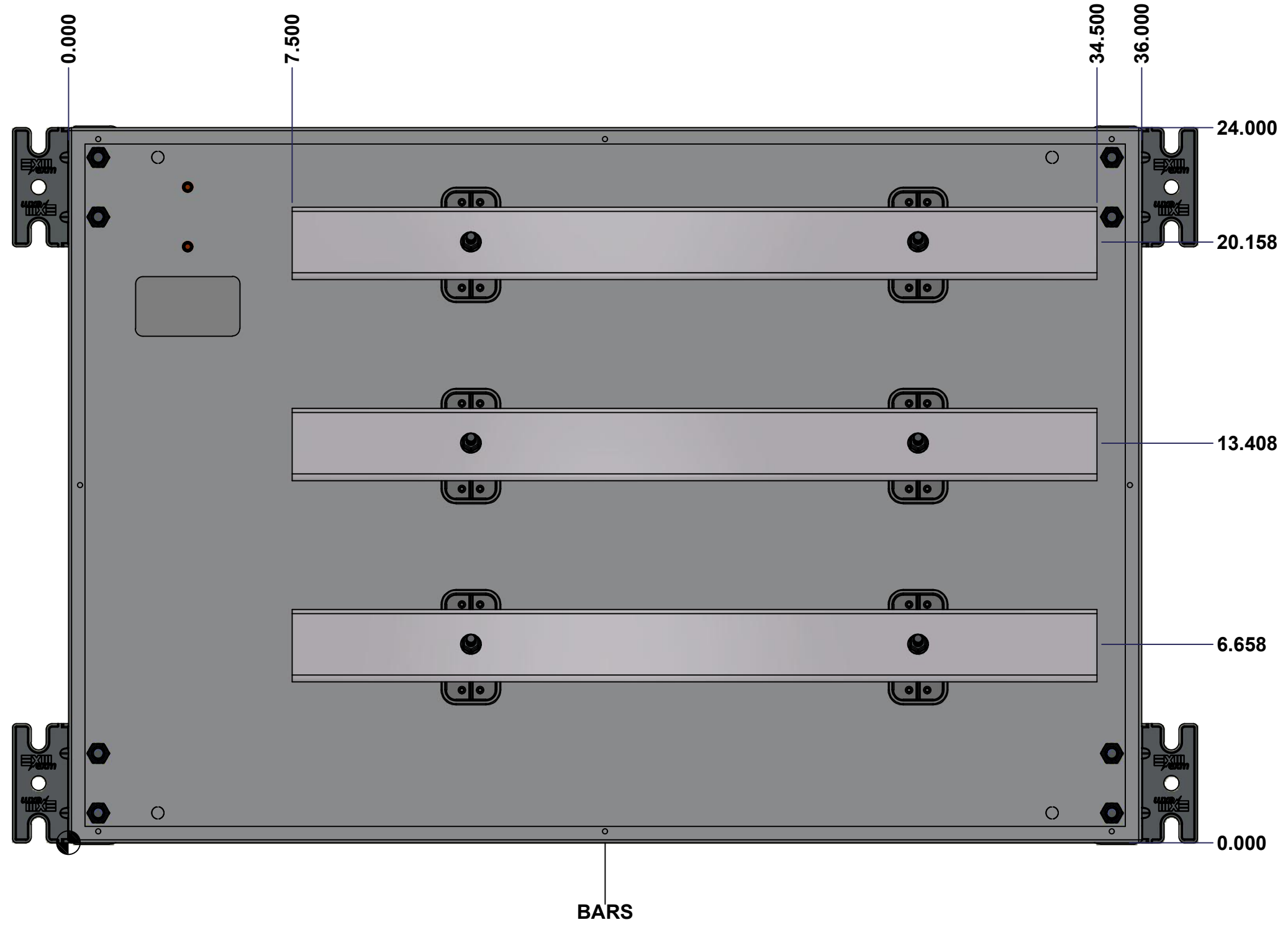

	Description		Status
	1100BT 600A - 3Wires x 36" Assembly		(NULL)
Part Number Numéro Pièce		Rev.	2
<b>1100BT03603</b>		<b>0</b>	8

This drawing is confidential and must not be reproduced or used without the consent of EXM

Ce dessin est confidentiel et ne doit pas être reproduit ou utilisé sans le consentement de EXM

**NOTE**

ITEM	DESCRIPTION
1	NEMA 1 Enclosure
2	C/W Standard ground studs on box and cover
3	W/O Standard door stiffener
4	W/O Inner panel
5	W/O Inner panel mounting studs

No.	Revisions	Date	By/Par

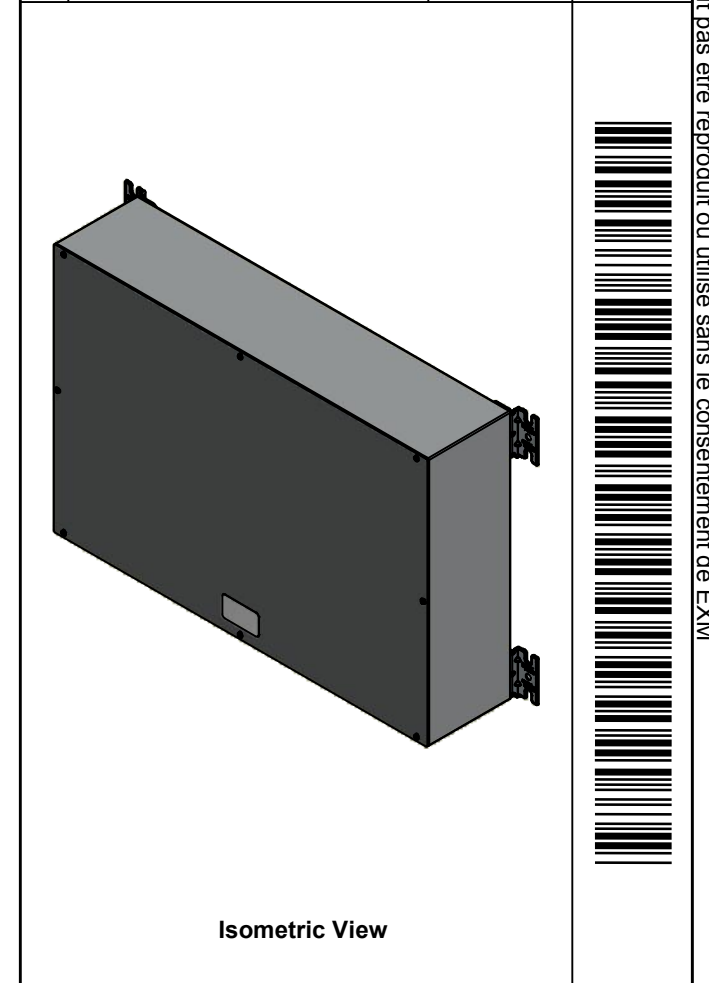

**EXM**  
www.exmweb.com

Tél: (450) 979-4373  
Fax: (450) 979-4626

Flatness  
Aplatissement  
Max 3.0mm

Projection

Customer Client	Date
Drawn By Dessiné Par	Date 25-Jul-22

Material Matière	14 Ga Cold Rolled A1008 CS Type B (1.7mm)
---------------------	---

Color Couleur	Asa-61 Grey	Finish Fini	Smooth
------------------	-------------	----------------	--------

Description	Detail Rev.
1100BT 600A - 3Wires x 36" Assembly	

Part Number Numéro Pièce	Rev.	3
<b>1100BT03603</b>	<b>0</b>	8

PACKING		
ITEM	QTY	DESCRIPTION
Cardboard sleeve	2	Top and Bottom
Cardboard strip	2	Between back of enclosure and inner panel
Plastic bag	1	To protect cover surface and inside gasket
Cardboard corner	4	To reinforced for the plastic strap tightening
Plastic strap - Black	2	To Squeeze 2 cardboard sleeve together
Packaging label	3	White label with PN
Plastic strap- Green	2	To secure the enclosure to the wood pallet
Wood Pallet	1	2" deeper and 3" larger than enclosure size

Qty	Part Number	Rev	Description
2	885 BTMF	0	885 BTMF Mounting Feet Kit
1	1100BT03603BAR2-P	0	Rounded Edge Aluminum Bar 3/8" x 2 1/2"
1	1100BT03603BAR1-P	0	Rounded Edge Aluminum Bar 3/8" x 2 1/2"
1	1100BT03603BAR3-P	0	Rounded Edge Aluminum Bar 3/8" x 2 1/2"
6	STK-Q-07310	2	Flange Lock Nut M8
6	STK-A-67400	0	Buss Bar Insulator Kit
8	STK-Q-05020	5	M5 x 8mm Thread Rolling Screw
1	1100BT03603C	0	1100BT 24" x 36" Cover
1	1100BT03603B	0	1100BT 24" x 36" x 8" Body
Parts List			

This drawing is confidential and must not be reproduced or used without the consent of EXM

Ce dessin est confidentiel et ne doit pas être reproduit ou utilisé sans le consentement de EXM



TOP

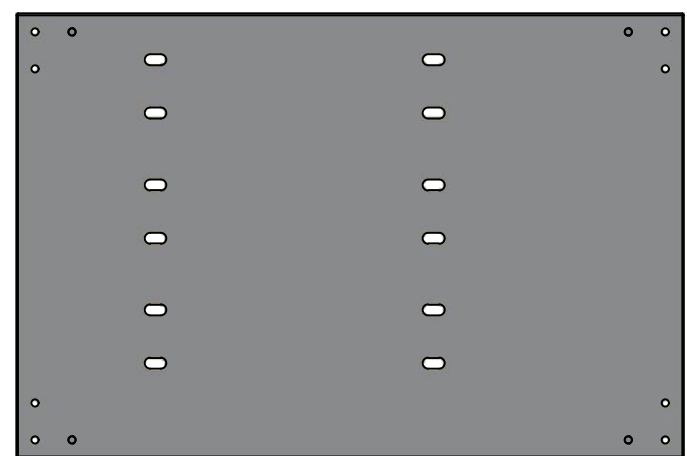

BACK

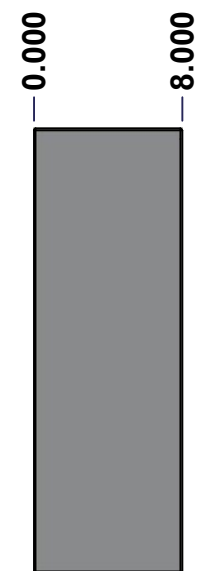

LEFT

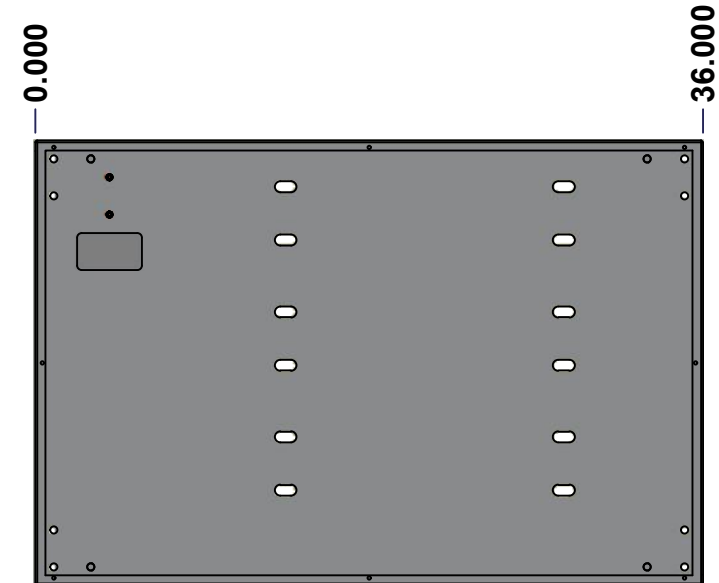

FRONT

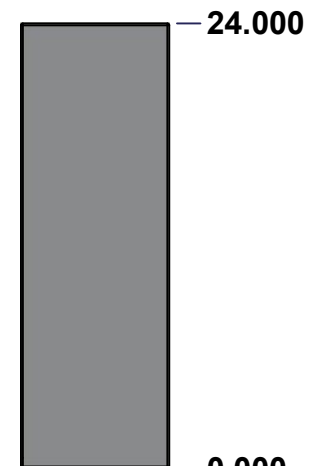

RIGHT



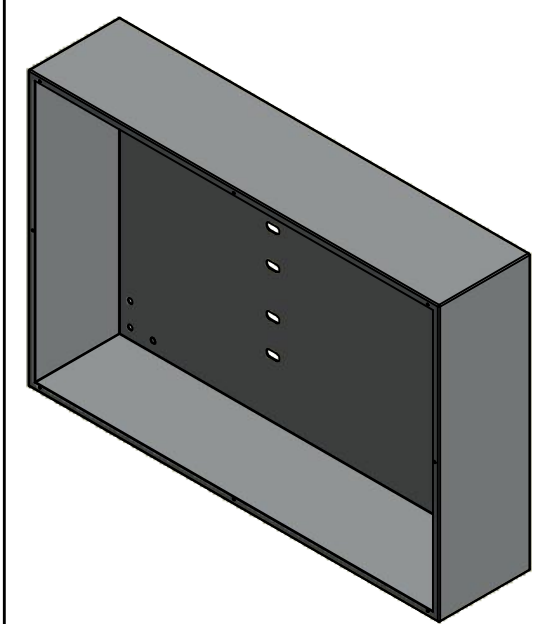

BOTTOM

No.	Revisions	Date	By/Par

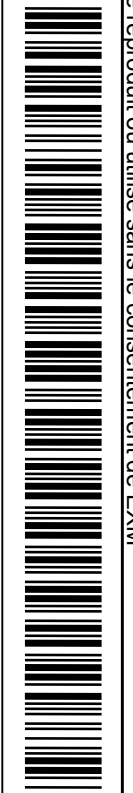

Isometric View

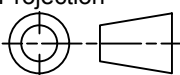

 Tél: (450) 979-4373  
 Fax: (450) 979-4626  
[www.exmweb.com](http://www.exmweb.com)

Flatness / Aplatissement: Max 3.0mm  
 Projection: 

Customer / Client	Date
Drawn By / Dessiné Par: BoxCad: BoxCad	Date: 25-Jul-22
Material / Matière: 14 Ga Cold Rolled A1008 CS Type B (1.7mm)	

Color / Couleur: Asa-61 Grey	Finish / Fini: Smooth
------------------------------	-----------------------

Description: 1100BT 24" x 36" x 8" Body	Detail Rev.
---	-------------

Part Number / Numéro Pièce: <b>1100BT03603B</b>	Rev. 0	4 / 8
---	--------	-------

SEE BILL OF MATERIAL ON LAST PAGE

This drawing is confidential and must not be reproduced or used without the consent of Eurobox

Ce dessin est confidentiel et ne doit pas être reproduit ou utilisé sans le consentement de Eurobox

<b>STANDARD FEATURES ARE NOT LISTED IN THIS HOLE TABLE</b>			
<b>HOLE TABLE - BACK VIEW (CUSTOM FEATURE ONLY)</b>			
CUT-OUT	XDIM	YDIM	DESCRIPTION
1	32.000	22.000	GND STUD M8 x 35mm (Inside)
2	32.000	20.000	GND STUD M8 x 35mm (Inside)

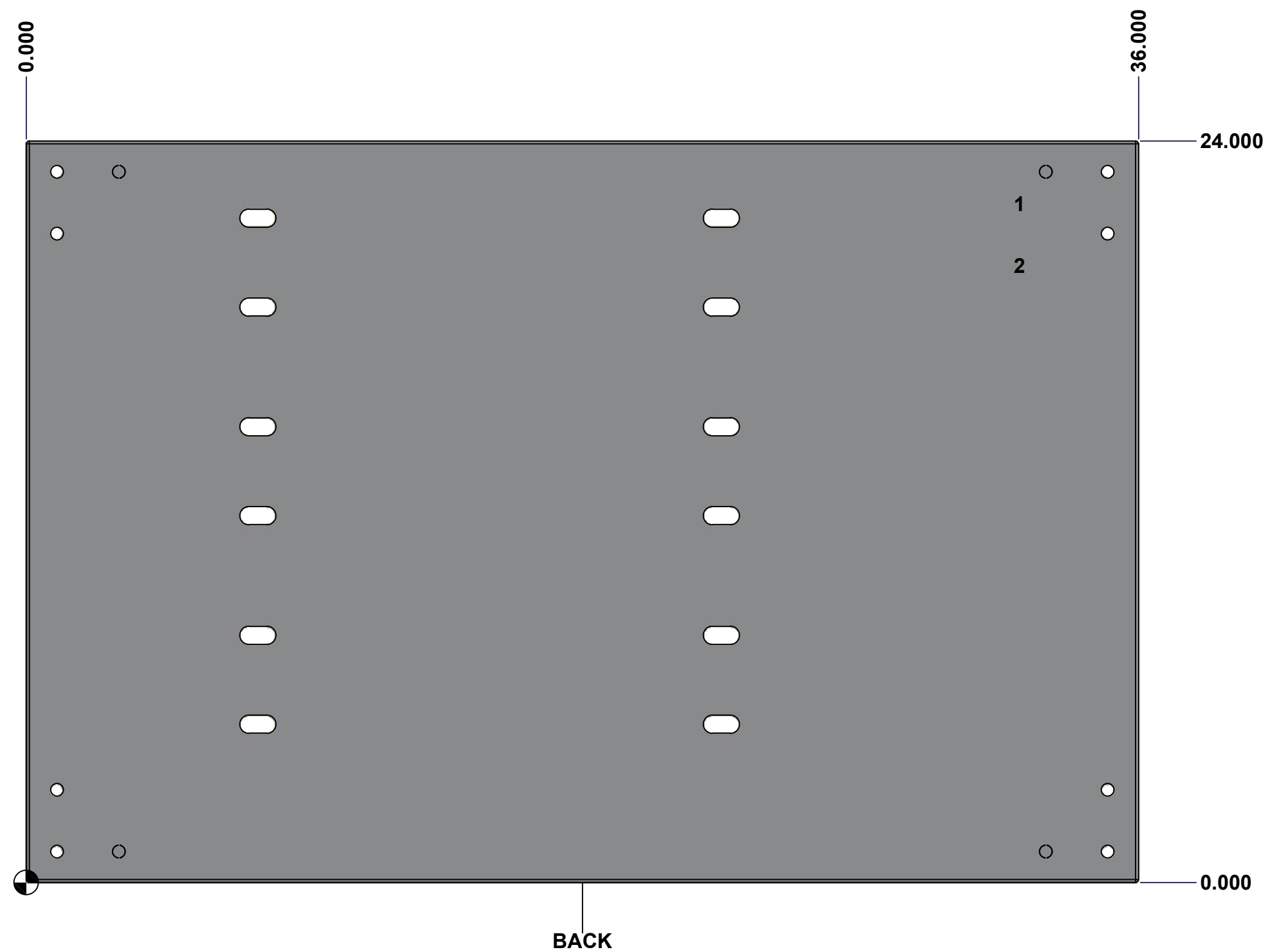



	Description 1100BT 24" x 36" x 8" Body	Status (NULL)
	Part Number Numéro Pièce <b>1100BT03603B</b>	Rev. 5 <b>0</b> / 8

This drawing is confidential and must not be reproduced or used without the consent of EXM

Ce dessin est confidentiel et ne doit pas être reproduit ou utilisé sans le consentement de EXM

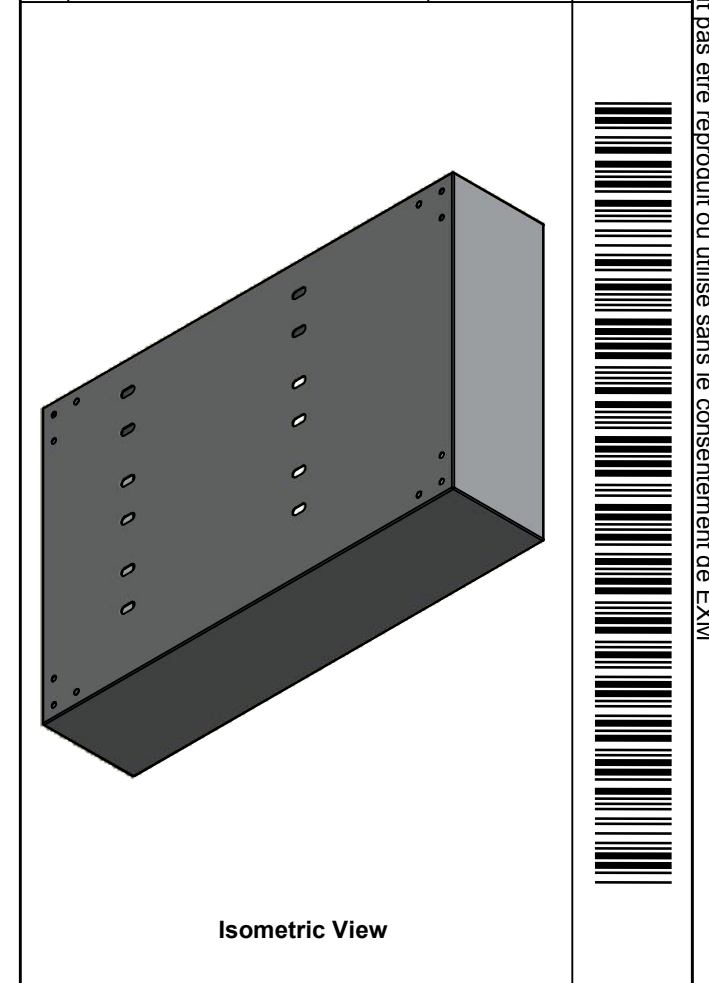
No.	Revisions	Date	By/Par



 Tél: (450) 979-4373 Fax: (450) 979-4626 <a href="http://www.exmweb.com">www.exmweb.com</a>		Flatness Aplatissement Max 3.0mm
Customer Client		Date
Drawn By / Dessiné Par: BoxCad: BoxCad		Date: 25-Jul-22
Material / Matière: 14 Ga Cold Rolled A1008 CS Type B (1.7mm)		
Color / Couleur: Asa-61 Grey	Finish / Fini: Smooth	
Description: 1100BT 24" x 36" x 8" Body		Detail Rev.
Part Number / Numéro Pièce: <b>1100BT03603B</b>		Rev. 0

Qty	Part Number	Rev	Description
1	STK-P-02400S	0	Powder Paint (Asa-61 Grey / Smooth)
1	STK-S-00100	0	3.5" x 2" Silver Milar Flexcon Sticker
2	STK-Q-16005	1	Stud M8 x 35 (No Paint Cap Required)
1	1100BT03603B-P	0	1100BT 24" x 36" x 8" Body Part
Parts List			

This drawing is confidential and must not be reproduced or used without the consent of EXM

Ce dessin est confidentiel et ne doit pas être reproduit ou utilisé sans le consentement de EXM

TOP

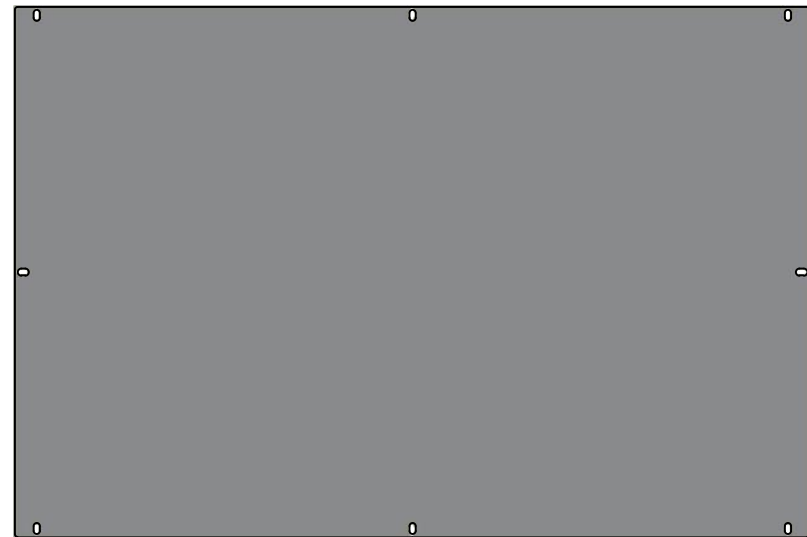

BACK

LEFT

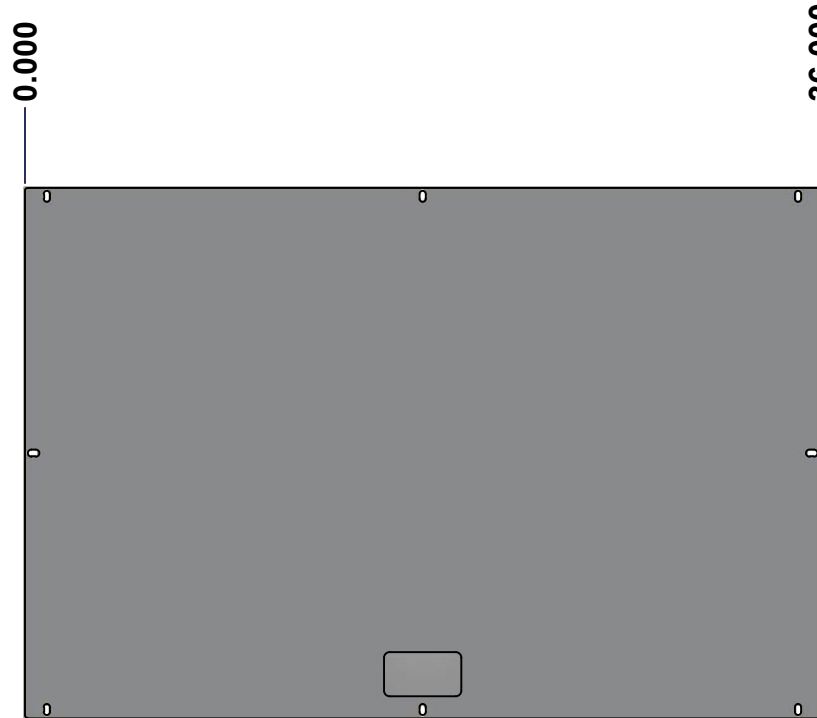

FRONT

RIGHT

24.000

0.000

BOTTOM

No.	Revisions	Date	By/Par

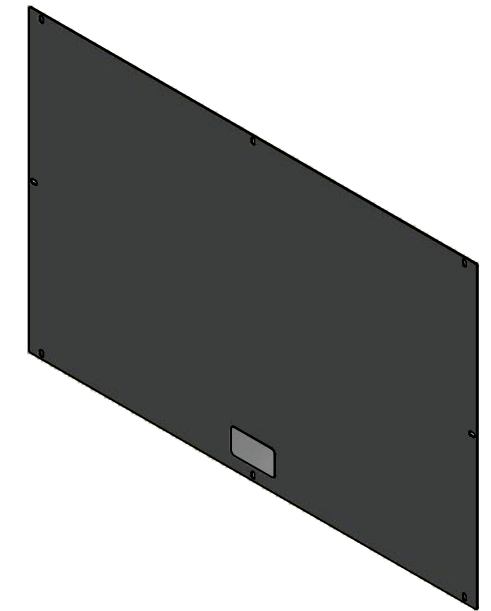

Isometric View



Tél: (450) 979-4373  
 Fax: (450) 979-4626  
[www.exmweb.com](http://www.exmweb.com)

Flatness  
Aplatissement

Max 3.0mm

Projection

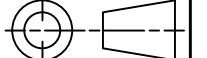

Customer Client	Date
Drawn By / Dessiné Par: BoxCad: BoxCad	Date: 25-Jul-22
Material / Matière: 14 Ga Cold Rolled A1008 CS Type B (1.7mm)	
Color / Couleur: Asa-61 Grey	Finish / Fini: Smooth
Description: 1100BT 24" x 36" Cover	Detail Rev.
Part Number / Numéro Pièce: 1100BT03603C	Rev. 0

SEE BILL OF MATERIAL ON LAST PAGE

This drawing is confidential and must not be reproduced or used without the consent of EXM

Ce dessin est confidentiel et ne doit pas être reproduit ou utilisé sans le consentement de EXM

No.	Revisions	Date	By/Par

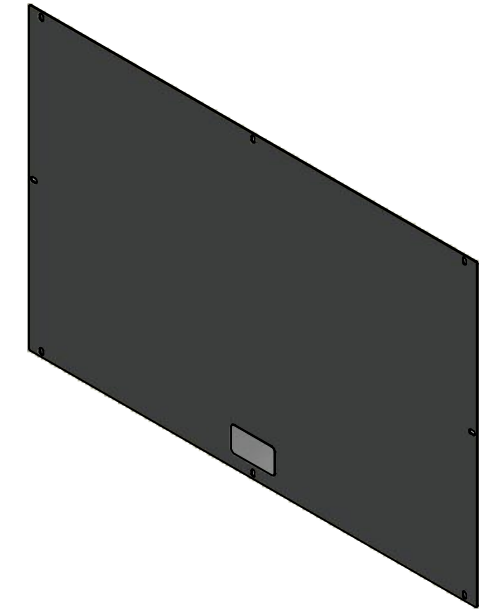

Isometric View

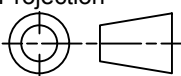
 Tél: (450) 979-4373 Fax: (450) 979-4626 <a href="http://www.exmweb.com">www.exmweb.com</a>		Flatness Aplatissement Max 3.0mm
Customer Client		Projection 
Drawn By / Dessiné Par: BoxCad: BoxCad		Date: 25-Jul-22
Material / Matière: 14 Ga Cold Rolled A1008 CS Type B (1.7mm)		
Color / Couleur: Asa-61 Grey	Finish / Fini: Smooth	
Description: 1100BT 24" x 36" Cover		Detail Rev.
Part Number / Numéro Pièce: <b>1100BT03603C</b>		Rev. 8 <b>0</b>

Qty	Part Name	Rev	Description
1	STK-P-02400S	0	Powder Paint (Asa-61 Grey / Smooth)
1	STK-S-00100	0	3.5" x 2" Silver Milar Flexcon Sticker
1	1100BT03603C-P	0	1100BT 24" x 36" Flat Cover Part
Parts List			