

This drawing is confidential and must not be reproduced or used without the consent of EXM

Ce dessin est confidentiel et ne doit pas être reproduit ou utilisé sans le consentement de EXM

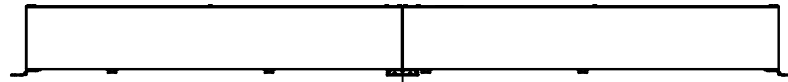

TOP

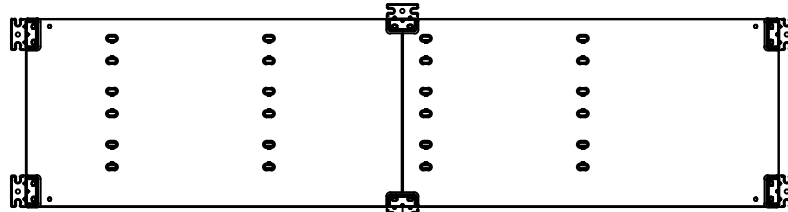

BACK

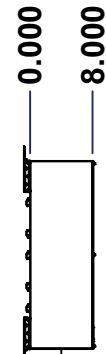

LEFT

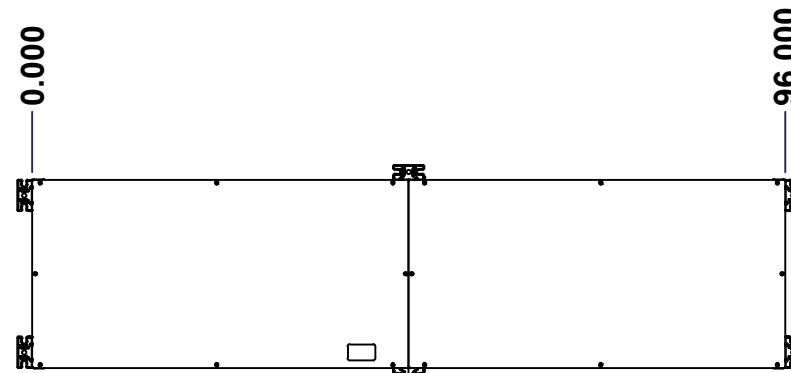

FRONT

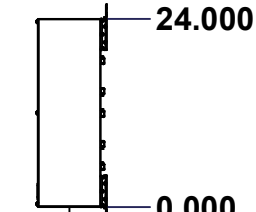



RIGHT

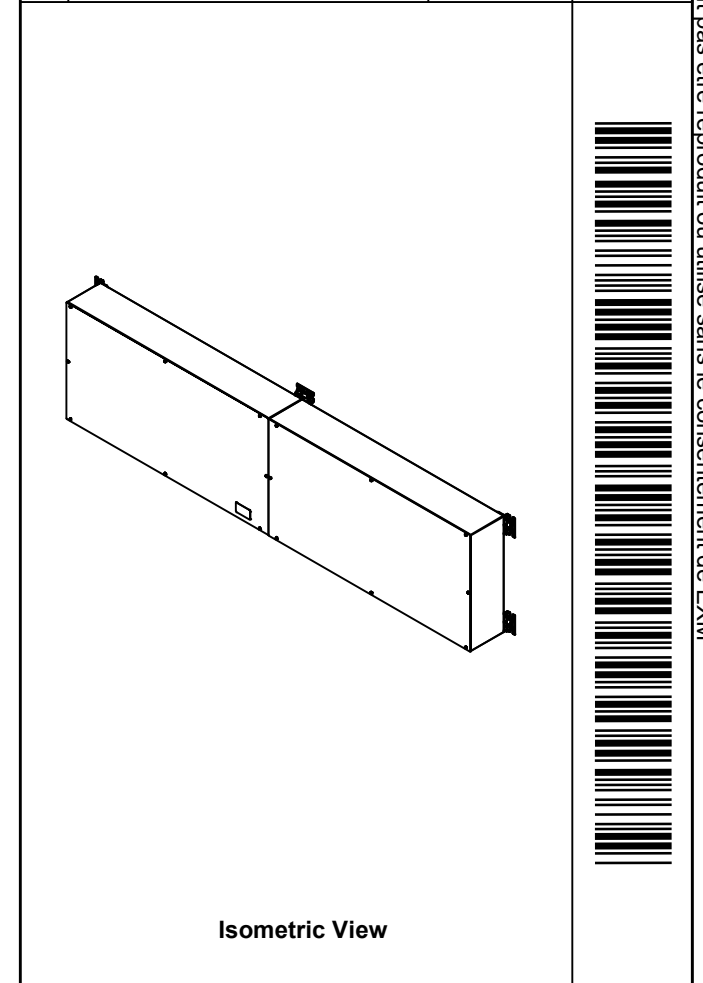

BOTTOM

No.	Revisions	Date	By/Par

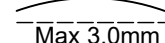
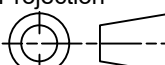

 Tél: (450) 979-4373 Fax: (450) 979-4626 www.exmweb.com		Flatness Aplatissement  Max 3.0mm Projection 
Customer Client	Date	
Drawn By Dessiné Par	BoxCad: BoxCad	Date 26-Jul-22
Material Matière	14 Ga Cold Rolled A1008 CS Type B (1.7mm)	
Color Couleur	Asa-61 Grey	Finish Fini Smooth
Description 1100BT 800A - 3Wires x 96" Assembly		Detail Rev.
Part Number Numéro Pièce	Rev. 0	1/8

SEE BILL OF MATERIAL ON LAST PAGE

1100BT08803

This drawing is confidential and must not be reproduced or used without the consent of Eurobox

STANDARD FEATURES ARE NOT LISTED IN THIS HOLE TABLE

Ce dessin est confidentiel et ne doit pas être reproduit ou utilisé sans le consentement de Eurobox

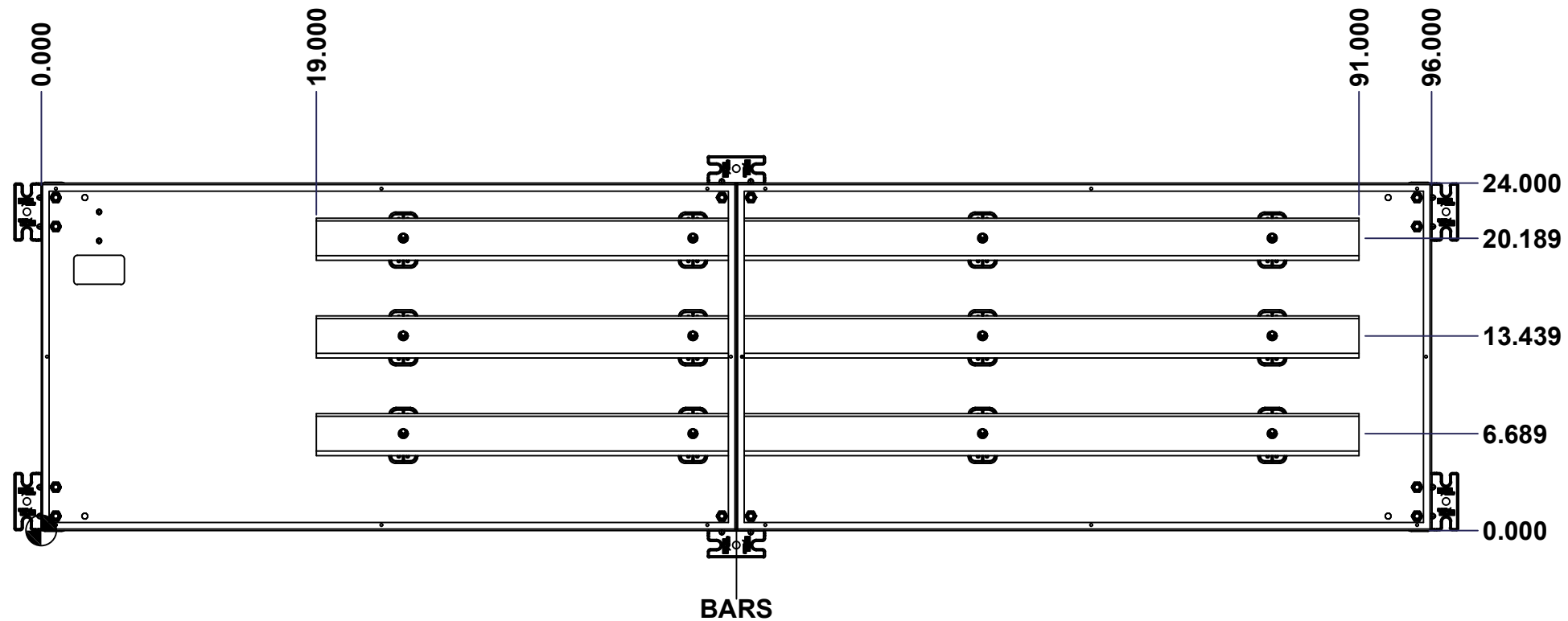

	Description		Status
	1100BT 800A - 3Wires x 96" Assembly		(NULL)
Part Number Numéro Pièce		Rev.	2
1100BT08803		0	8

This drawing is confidential and must not be reproduced or used without the consent of EXM

Ce dessin est confidentiel et ne doit pas être reproduit ou utilisé sans le consentement de EXM

NOTE	
ITEM	DESCRIPTION
1	NEMA 1 Enclosure (IP20)
2	C/W Standard ground studs on box and cover
3	W/O Standard door stiffener
4	W/O Inner panel
5	W/O Inner panel mounting studs

No.	Revisions	Date	By/Par

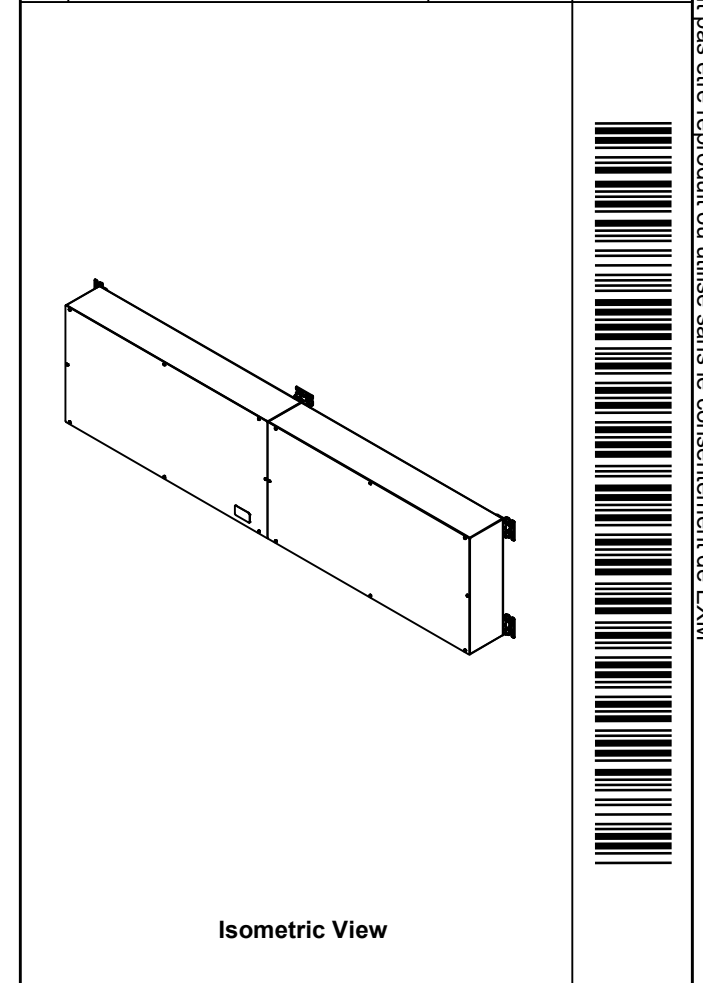

PACKING		
ITEM	QTY	DESCRIPTION
Cardboard sleeve	2	Top and Bottom
Cardboard strip	2	Between back of enclosure and inner panel
Plastic bag	1	To protect cover surface and inside gasket
Cardboard corner	4	To reinforced for the plastic strap tightening
Plastic strap - Black	2	To Squeeze 2 cardboard sleeve together
Packaging label	3	White label with PN
Plastic strap- Green	2	To secure the enclosure to the wood pallet
Wood Pallet	1	2" deeper and 3" larger than enclosure size

1	1100BT08803BAR3-P	0	Rounded Edge Aluminum Bar 1/2" x 3"
1	1100BT08803BAR2-P	0	Rounded Edge Aluminum Bar 1/2" x 3"
1	1100BT08803BAR1-P	0	Rounded Edge Aluminum Bar 1/2" x 3"
10	STK-Q-07220	1	M6 Nylon Insert Lock Nut
10	STK-Q-00260	1	M6 x 13mm Carriage Bolt
12	STK-Q-07310	3	Flange Lock Nut M8
12	STK-A-67400	0	Buss Bar Insulator Kit
16	STK-Q-05020	5	M5 x 8mm Thread Rolling Screw
1	1100BT08803C	0	1100BT 24" x 96" Cover
1	1100BT08803B	0	1100BT 24" x 96" x 8" Body
3	885 BTMF	0	885 BTMF Mounting Feet Kit
Qty	Part Number	Rev	Description
Parts List			

	Tél: (450) 979-4373 Fax: (450) 979-4626 www.exmweb.com	Flatness Aplatissement Max 3.0mm
	Projection 	Customer Client
Drawn By Dessiné Par	BoxCad: BoxCad	Date 26-Jul-22
Material Matière	14 Ga Cold Rolled A1008 CS Type B (1.7mm)	
Color Couleur	Asa-61 Grey	Finish Fini Smooth
Description 1100BT 800A - 3Wires x 96" Assembly		Detail Rev.
Part Number Numéro Pièce 1100BT08803		Rev. 3 0

This drawing is confidential and must not be reproduced or used without the consent of EXM

Ce dessin est confidentiel et ne doit pas être reproduit ou utilisé sans le consentement de EXM

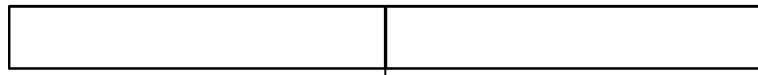

TOP

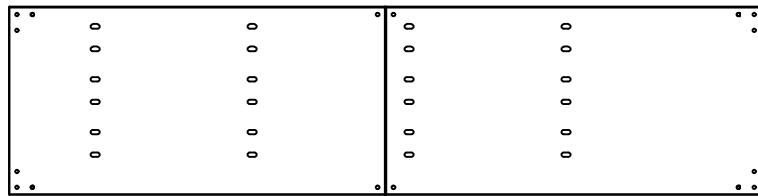

BACK

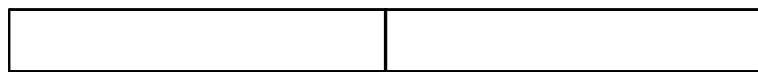

BOTTOM

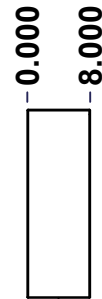

LEFT

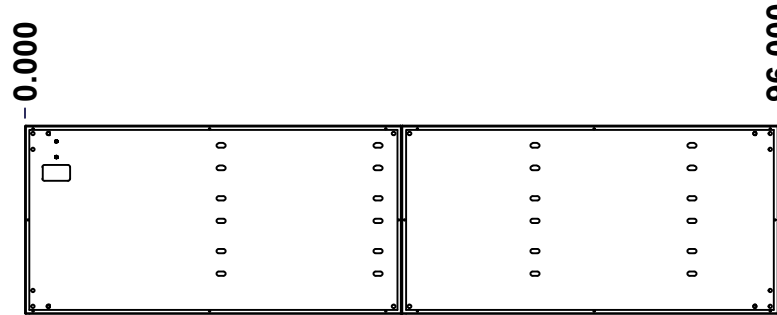

FRONT

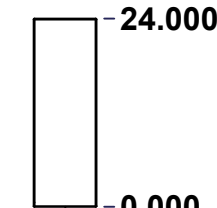

RIGHT

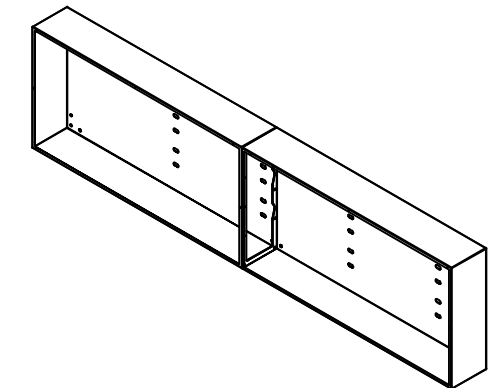

Isometric View

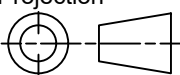

No.	Revisions	Date	By/Par

 Tél: (450) 979-4373 Fax: (450) 979-4626 www.exmweb.com		Flatness Aplatissement Max 3.0mm Projection 
Customer Client	Date	
Drawn By Dessiné Par	BoxCad: BoxCad	Date 26-Jul-22
Material Matière	14 Ga Cold Rolled A1008 CS Type B (1.7mm)	
Color Couleur	Asa-61 Grey	Finish Fini Smooth
Description	Detail Rev.	
1100BT 24" x 96" x 8" Body		
Part Number Numéro Pièce	Rev.	4
1100BT08803B	0	8

SEE BILL OF MATERIAL ON LAST PAGE

This drawing is confidential and must not be reproduced or used without the consent of Eurobox

Ce dessin est confidentiel et ne doit pas être reproduit ou utilisé sans le consentement de Eurobox

STANDARD FEATURES ARE NOT LISTED IN THIS HOLE TABLE			
HOLE TABLE - BACK VIEW (CUSTOM FEATURE ONLY)			
CUT-OUT	XDIM	YDIM	DESCRIPTION
1	92.000	22.000	GND STUD M8 x 35mm (Inside)
2	92.000	20.000	GND STUD M8 x 35mm (Inside)

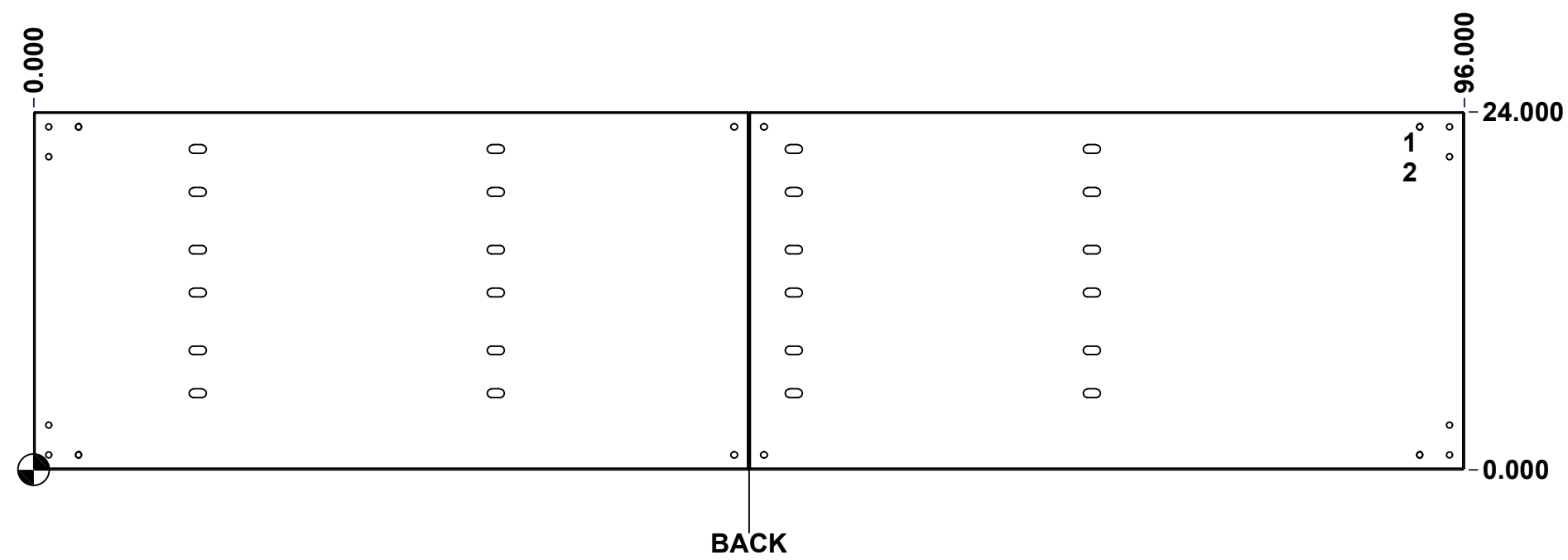

	Description	Status	
	1100BT 24" x 96" x 8" Body	(NULL)	
	Part Number Numéro Pièce	Rev.	
	1100BT08803B	0	5 8

This drawing is confidential and must not be reproduced or used without the consent of EXM

Ce dessin est confidentiel et ne doit pas être reproduit ou utilisé sans le consentement de EXM

No.	Revisions	Date	By/Par

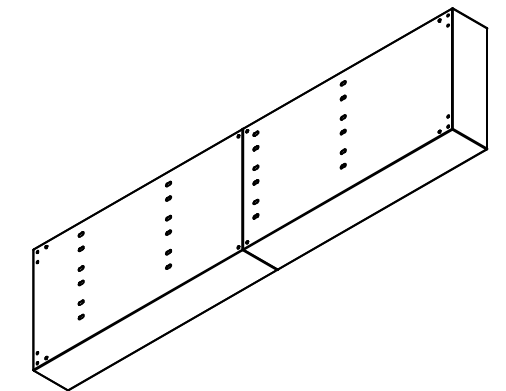

Isometric View



 Tél: (450) 979-4373 Fax: (450) 979-4626 www.exmweb.com		Flatness Aplatissement Max 3.0mm
Customer Client		Date
Drawn By / Dessiné Par: BoxCad: BoxCad		Date: 26-Jul-22
Material / Matière: 14 Ga Cold Rolled A1008 CS Type B (1.7mm)		
Color / Couleur: Asa-61 Grey	Finish / Fini: Smooth	
Description: 1100BT 24" x 96" x 8" Body		Detail Rev.
Part Number / Numéro Pièce: 1100BT08803B		Rev. 0

Qty	Part Number	Rev	Description
1	STK-P-02400S	0	Powder Paint (Asa-61 Grey / Smooth)
1	1100BT08803B-P	0	1100BT 24" x 96" x 8" Body Part
1	STK-S-00100	0	3.5" x 2" Silver Milar Flexcon Sticker
2	STK-Q-16005	0	Stud M8 x 35mm Steel
1	1100BT08803E-P	0	1100BT 24" x 96" x 8" Body Part
Parts List			

This drawing is confidential and must not be reproduced or used without the consent of EXM

Ce dessin est confidentiel et ne doit pas être reproduit ou utilisé sans le consentement de EXM

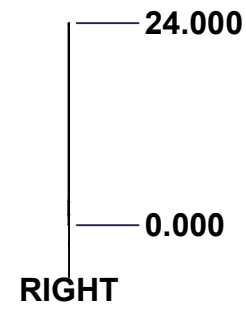
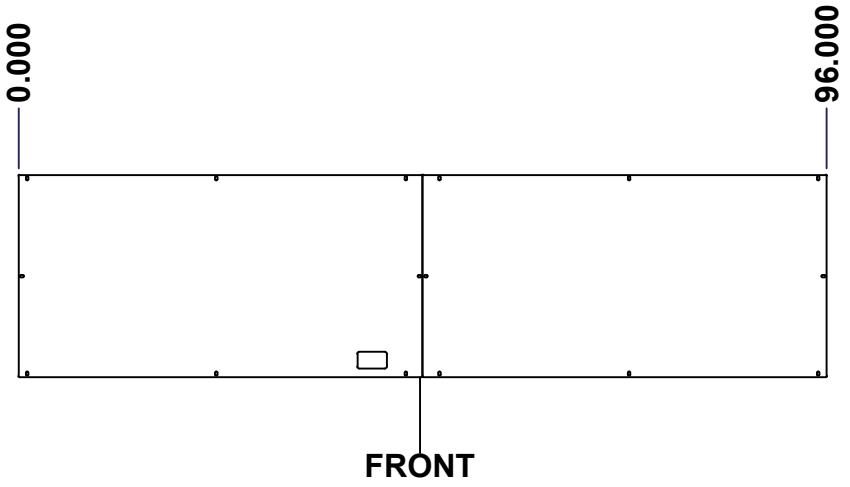
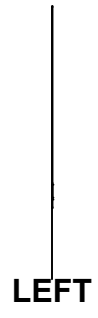
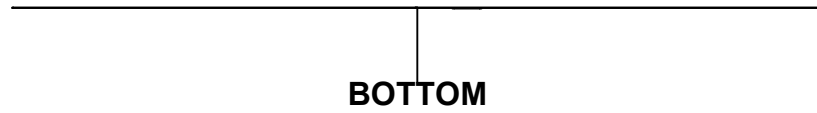
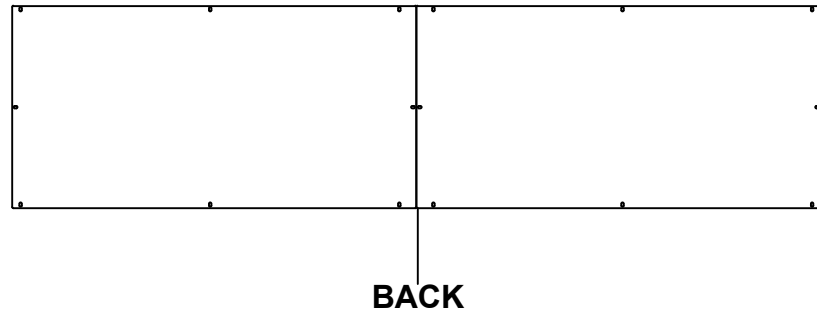

No.	Revisions	Date	By/Par

Isometric View

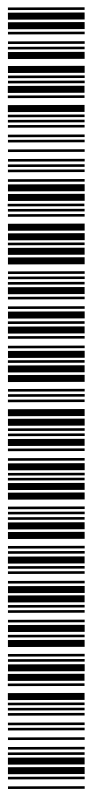

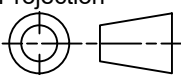
 Tél: (450) 979-4373 Fax: (450) 979-4626 www.exmweb.com		Flatness Aplatissement Max 3.0mm Projection 
Customer Client	Date	
Drawn By Dessiné Par	BoxCad: BoxCad	Date 26-Jul-22
Material Matière	14 Ga Cold Rolled A1008 CS Type B (1.7mm)	
Color Couleur	Asa-61 Grey	Finish Fini Smooth
Description	Detail Rev.	
1100BT 24" x 96" Cover		
Part Number Numéro Pièce	Rev.	7
1100BT08803C	0	8

SEE BILL OF MATERIAL ON LAST PAGE

This drawing is confidential and must not be reproduced or used without the consent of EXM

Ce dessin est confidentiel et ne doit pas être reproduit ou utilisé sans le consentement de EXM

No.	Revisions	Date	By/Par

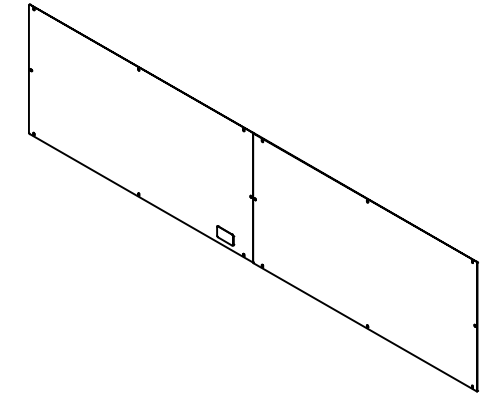

Isometric View

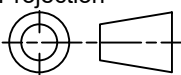

 Tél: (450) 979-4373 Fax: (450) 979-4626 www.exmweb.com	Flatness Aplatissement Max 3.0mm
	Projection 
Customer Client	Date
Drawn By Dessiné Par BoxCad: BoxCad	Date 26-Jul-22
Material Matière 14 Ga Cold Rolled A1008 CS Type B (1.7mm)	
Color Couleur Asa-61 Grey	Finish Fini Smooth
Description 1100BT 24" x 96" Cover	
Part Number Numéro Pièce 1100BT08803C	Rev. 8 0

Qty	Part Name	Rev	Description
1	STK-P-02400S	0	Powder Paint (Asa-61 Grey / Smooth)
1	1100BT08803F-P	0	1100BT 24" x 96" Flanged Cover Part
1	1100BT08803C-P	0	1100BT 24" x 96" Flat Cover Part
1	STK-S-00100	0	3.5" x 2" Silver Milar Flexcon Sticker
Parts List			