

This drawing is confidential and must not be reproduced or used without the consent of EXM

Ce dessin est confidentiel et ne doit pas être reproduit ou utilisé sans le consentement de EXM

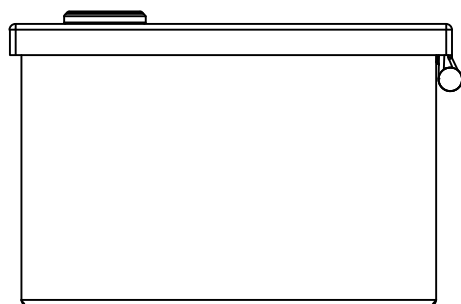

TOP

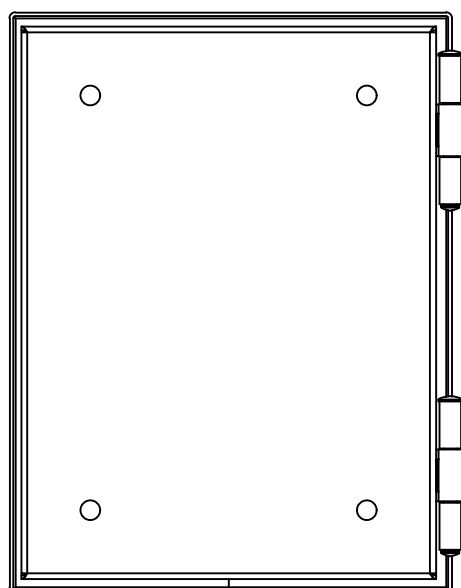

BACK

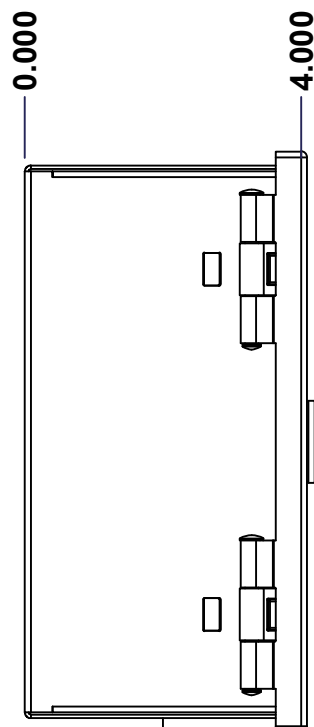

LEFT

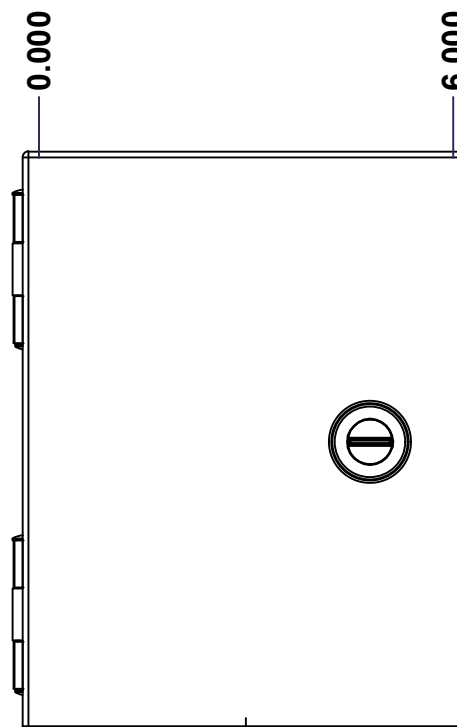

FRONT

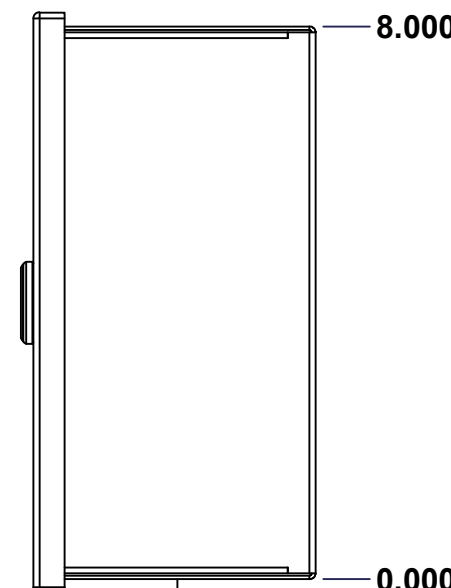

RIGHT

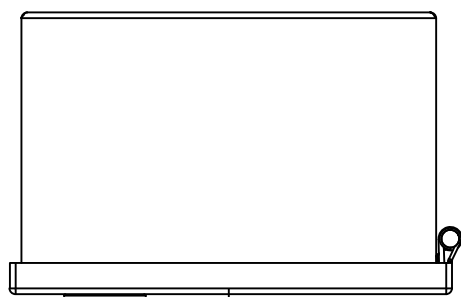

BOTTOM

No.	Revisions	Date	By/Par

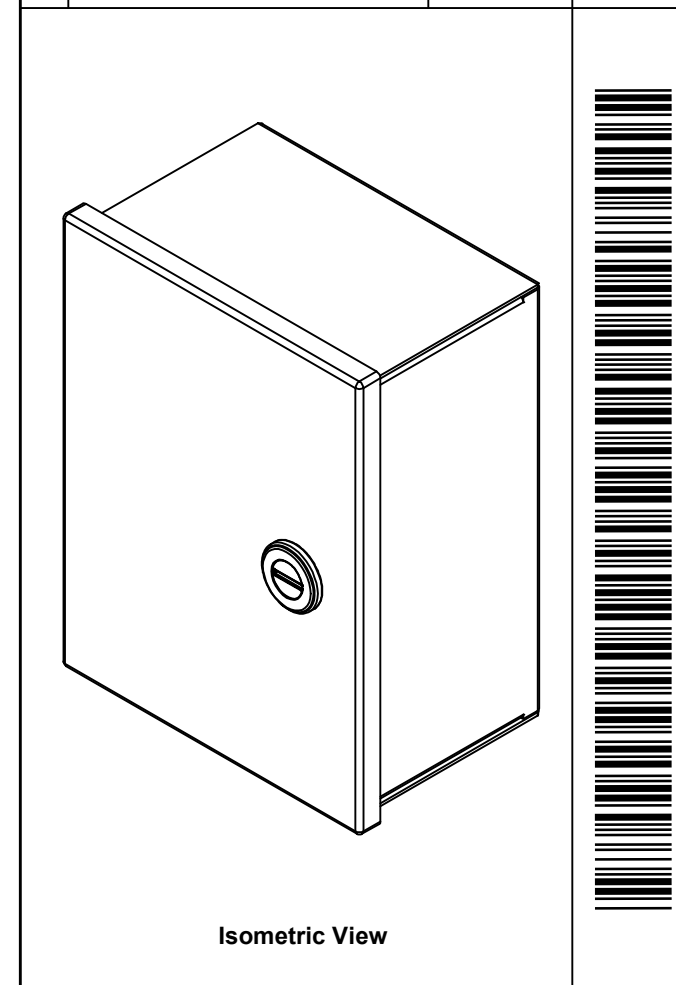

Isometric View

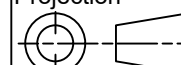
 Tél: (450) 979-4373 Fax: (450) 979-4626 www.exmweb.com		Flatness Aplatissement Max 3.0mm Projection 
Customer Client	Date	
Drawn By Dessiné Par	BoxCad: BoxCad	Date 03-Mar-26
Material Matière	16 Ga Cold Rolled A1008 CS Type B (1.4mm)	
Color Couleur	Asa-61 Grey	Finish Fini Smooth
Description 1100EHN 8" x 6" x 4" Assembly		Detail Rev.
Part Number Numéro Pièce	Rev. 0	1/8

SEE BILL OF MATERIAL ON LAST PAGE

1100EH080604N

This drawing is confidential and must not be reproduced or used without the consent of EXM

Ce dessin est confidentiel et ne doit pas être reproduit ou utilisé sans le consentement de EXM

NOTE	
ITEM	DESCRIPTION
1	NEMA 1 Enclosure (IP20)
2	C/W Standard ground provision on box and cover
3	W/O Standard door stiffener
4	W/O Inner panel
5	W/O Inner panel mounting provision

No.	Revisions	Date	By/Par

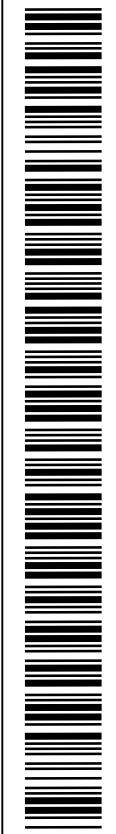
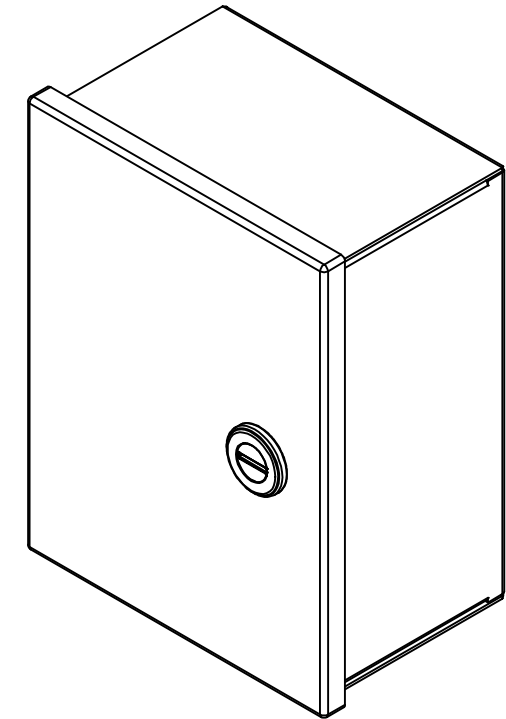

Isometric View



Tél: (450) 979-4373
 Fax: (450) 979-4626
www.exmweb.com



Customer Client	Date
Drawn By / Dessiné Par: BoxCad: BoxCad	Date: 03-Mar-26
Material / Matière: 16 Ga Cold Rolled A1008 CS Type B (1.4mm)	
Color / Couleur: Asa-61 Grey	Finish / Fini: Smooth

PACKING		
ITEM	QTY	DESCRIPTION
Thermal plastic film	1	Use with Packing Tunnel Wrapper Machine
Packaging label	1	White label with product number

Qty	Part Number	Rev	Description
2	STK-A-33710	0	1100 EH Hinge - 55mm Stainless Steel Press-fit pin
1	1100EH080604NC	0	1100EHN 8" x 6" Cover
1	1100EH080604NB	0	1100EHN 8" x 6" x 4" Body

Parts List

Description: 1100EHN 8" x 6" x 4" Assembly		Detail Rev.	
Part Number / Numéro Pièce: 1100EH080604N		Rev.:	2
		0	8

This drawing is confidential and must not be reproduced or used without the consent of EXM

Ce dessin est confidentiel et ne doit pas être reproduit ou utilisé sans le consentement de EXM

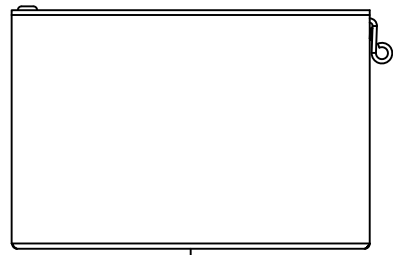

TOP

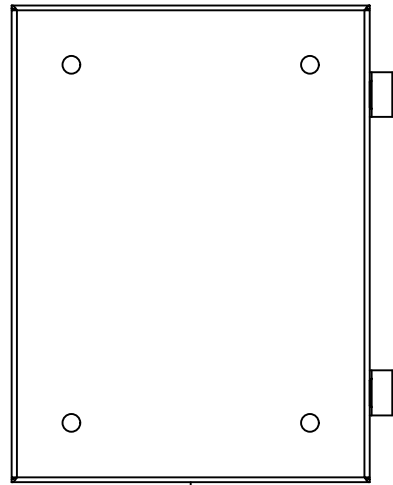

BACK

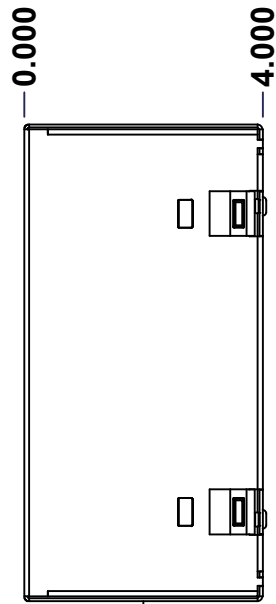

LEFT

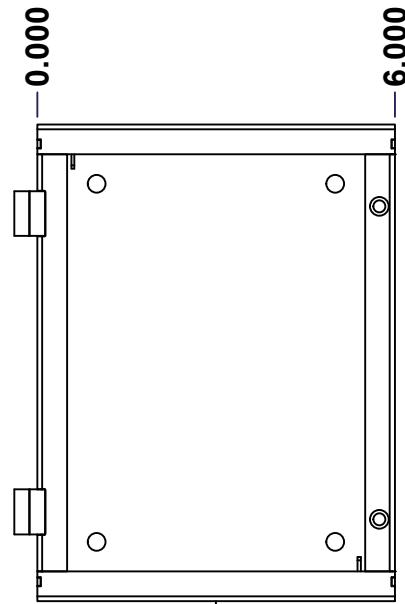

FRONT

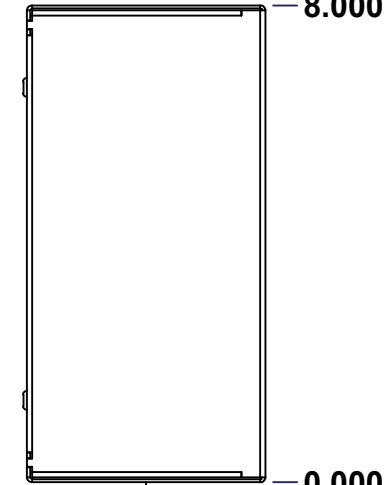

RIGHT

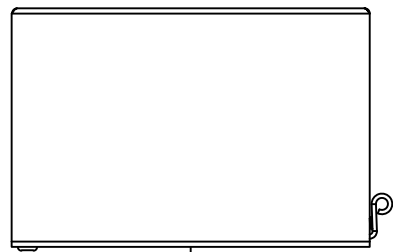

BOTTOM

No.	Revisions	Date	By/Par

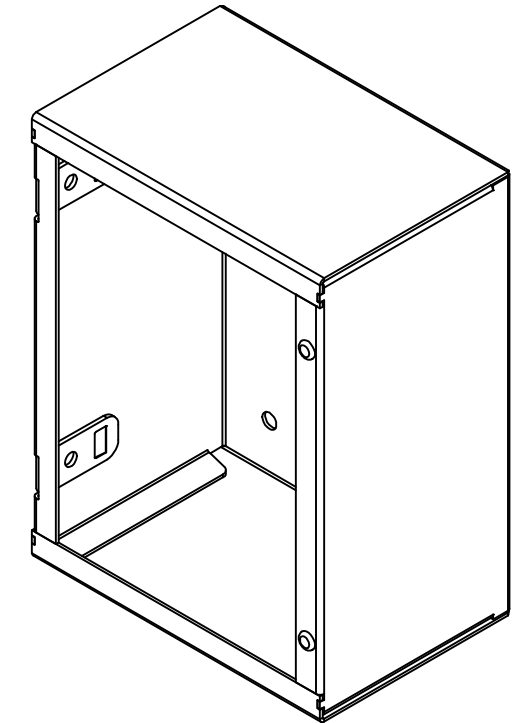

Isometric View



Tél: (450) 979-4373
 Fax: (450) 979-4626
www.exmweb.com

Flatness
Aplatissement

Max 3.0mm

Projection

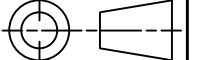

Customer Client	Date
Drawn By / Dessiné Par: BoxCad: BoxCad	Date: 03-Mar-26
Material / Matière: 16 Ga Cold Rolled A1008 CS Type B (1.4mm)	
Color / Couleur: Asa-61 Grey	Finish / Fini: Smooth
Description: 1100EHN 8" x 6" x 4" Body	
Detail Rev.	
Part Number / Numéro Pièce: 1100EH080604NB	Rev. 0
	3 / 8

SEE BILL OF MATERIAL ON LAST PAGE

This drawing is confidential and must not be reproduced or used without the consent of EXM

Ce dessin est confidentiel et ne doit pas être reproduit ou utilisé sans le consentement de EXM

STANDARD FEATURES ARE NOT LISTED IN THIS HOLE TABLE

HOLE TABLE - BACK VIEW (CUSTOM FEATURE ONLY)

CUT-OUT	XDIM	YDIM	DESCRIPTION
1	1.000	1.000	RND Ø0.290
2	1.000	7.000	RND Ø0.290
3	5.000	1.000	RND Ø0.290
4	5.000	7.000	RND Ø0.290

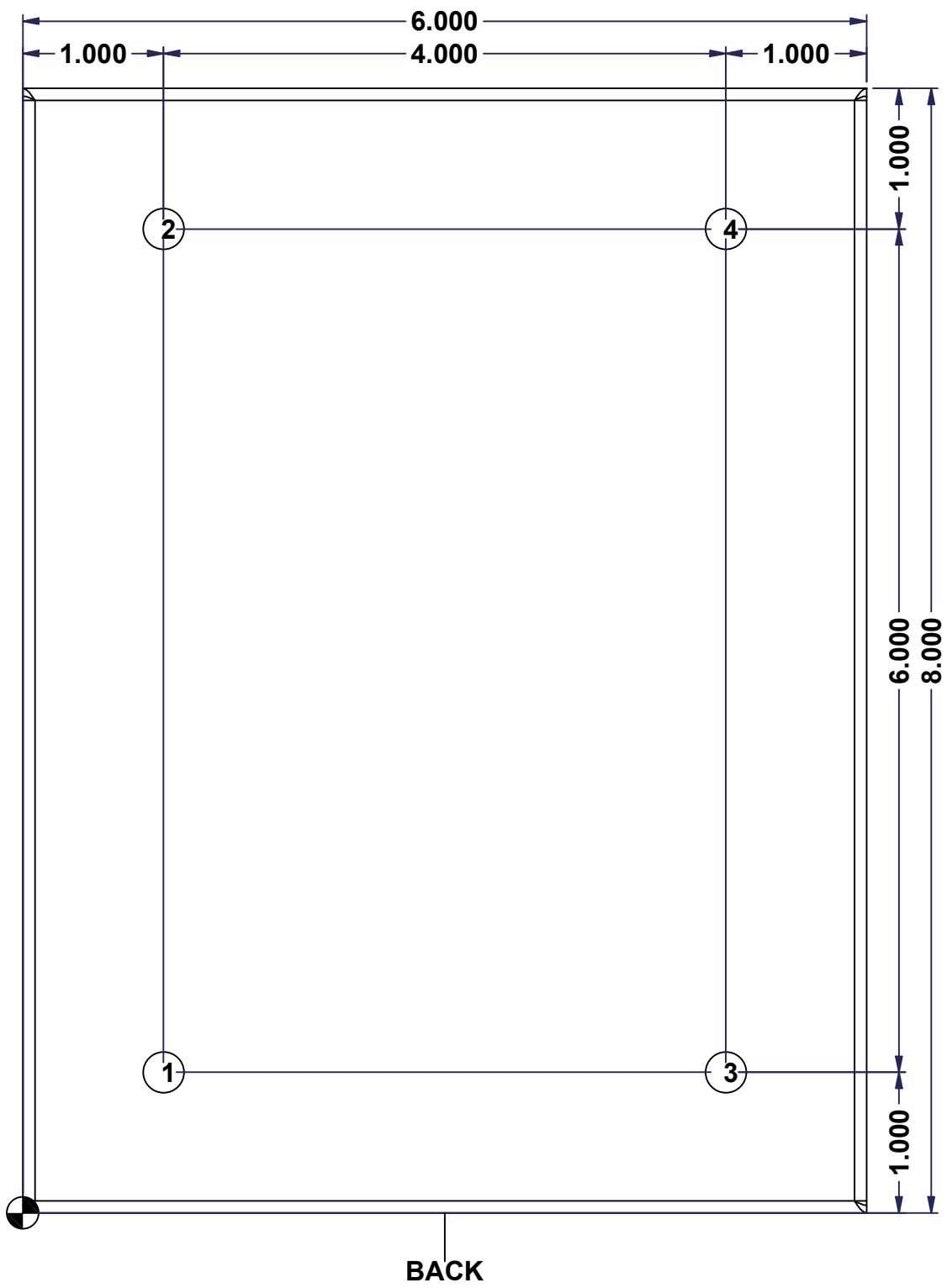

BACK

	Description	Status	
	1100EHN 8" x 6" x 4" Body	(NULL)	
	Part Number Numéro Pièce	Rev.	
	1100EH080604NB	0	4 8

This drawing is confidential and must not be reproduced or used without the consent of EXM

Ce dessin est confidentiel et ne doit pas être reproduit ou utilisé sans le consentement de EXM

No.	Revisions	Date	By/Par

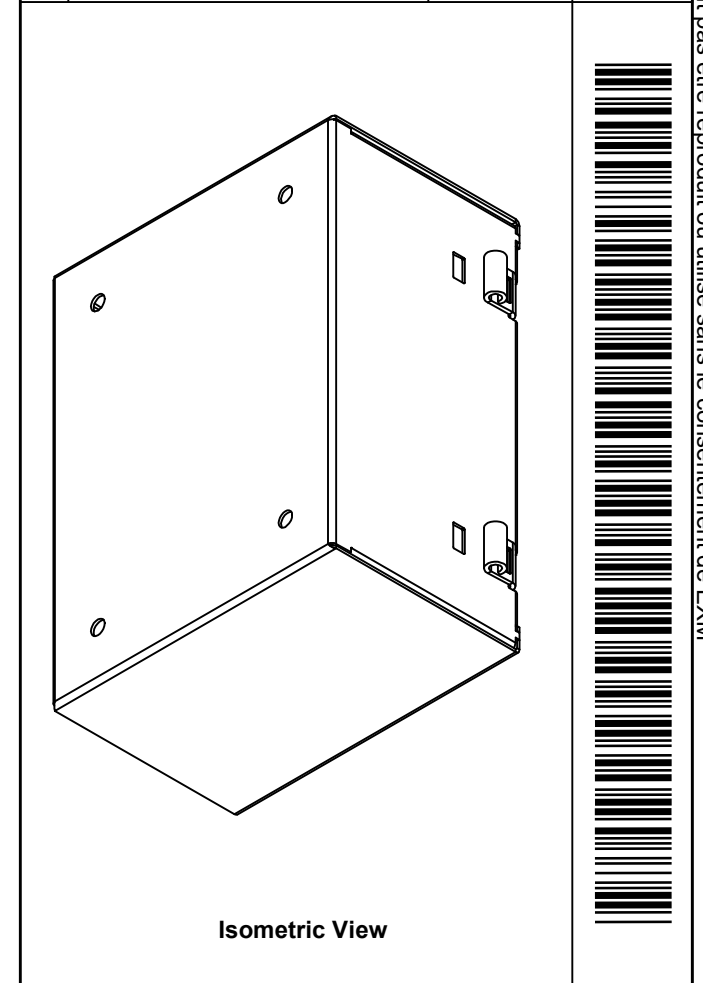

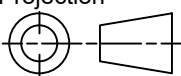
 Tél: (450) 979-4373 Fax: (450) 979-4626 www.exmweb.com		Flatness Aplatissement Max 3.0mm Projection 
Customer Client	Date	
Drawn By / Dessiné Par: BoxCad: BoxCad	Date: 03-Mar-26	
Material / Matière: 16 Ga Cold Rolled A1008 CS Type B (1.4mm)		
Color / Couleur: Asa-61 Grey	Finish / Fini: Smooth	
Description: 1100EHN 8" x 6" x 4" Body		Detail Rev.
Part Number / Numéro Pièce: 1100EH080604NB	Rev.:	5 / 8

Qty	Part Number	Rev	Description
1	STK-P-02400S	0	Powder Paint (Asa-61 Grey / Smooth)
2	STK-Q-77110	1	5412 ES Cover Plastic Plug
2	STK-Q-33410-P	5	1100 MC Left Side Hinge
1	1100EH080604NB-P	0	1100EHN 8" x 6" x 4" Body Part
Parts List			

This drawing is confidential and must not be reproduced or used without the consent of EXM

Ce dessin est confidentiel et ne doit pas être reproduit ou utilisé sans le consentement de EXM

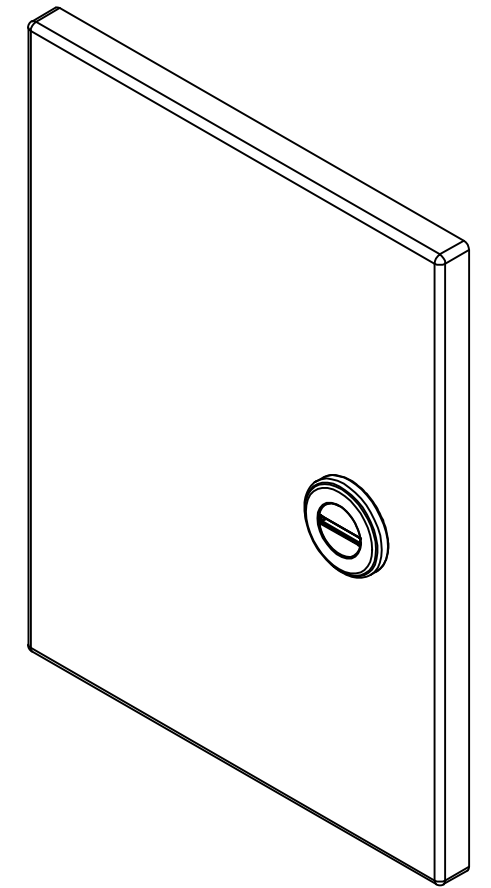
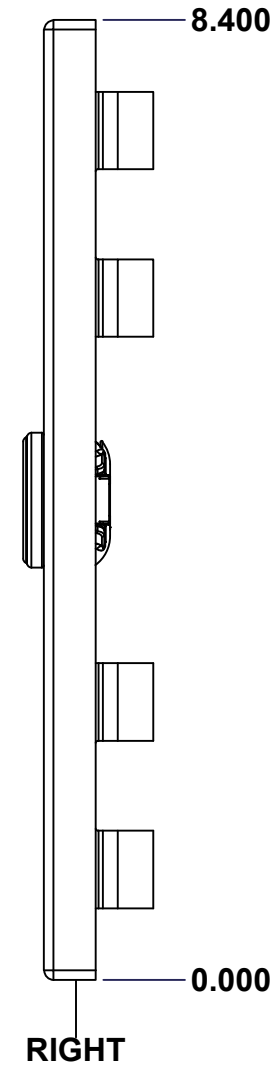
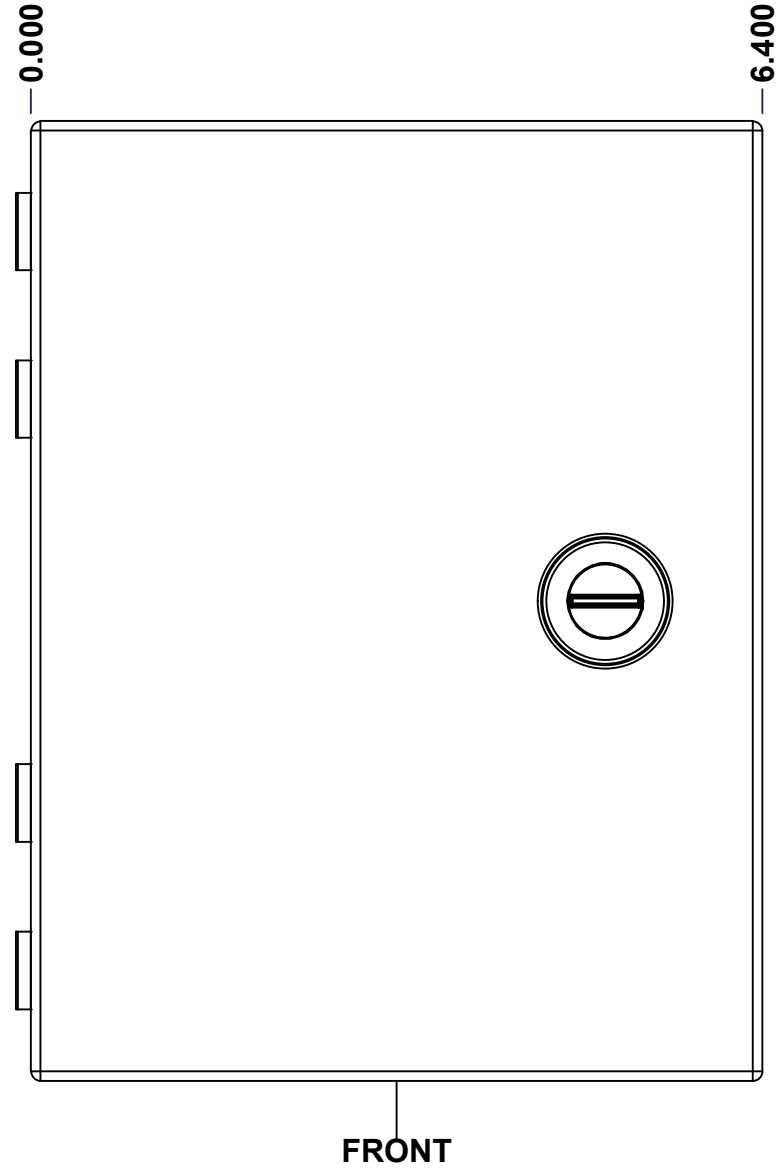
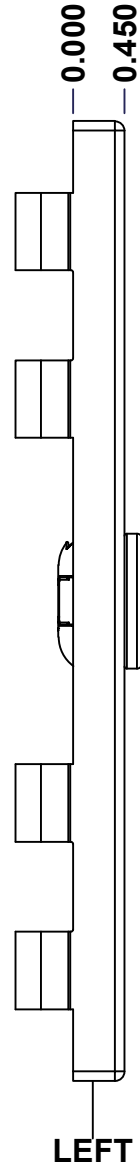
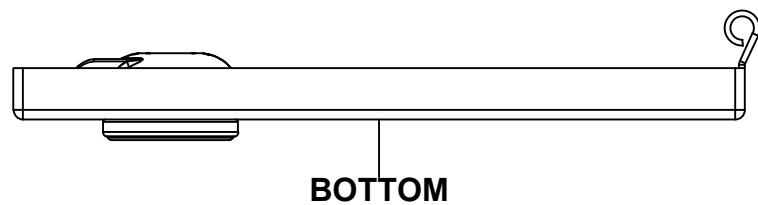
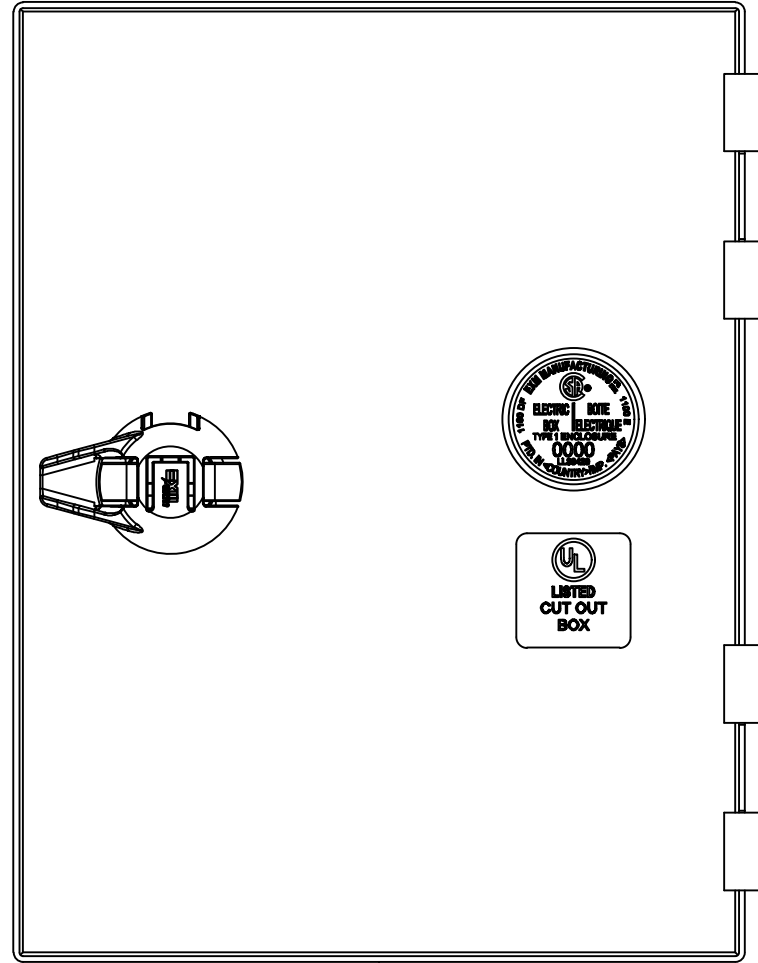
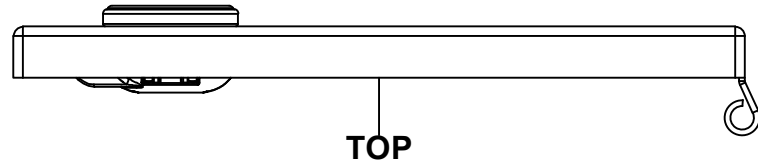

No.	Revisions	Date	By/Par

 Tél: (450) 979-4373 Fax: (450) 979-4626 www.exmweb.com		Flatness Aplatissement	
		Max 3.0mm	
Customer Client		Date	
Drawn By Dessiné Par BoxCad: BoxCad		Date 03-Mar-26	
Material Matière 16 Ga Cold Rolled A1008 CS Type B (1.4mm)			
Color Couleur Asa-61 Grey		Finish Fini Smooth	
Description 1100EHN 8" x 6" Cover			Detail Rev.
Part Number Numéro Pièce 1100EH080604NC		Rev. 0	6 8

SEE BILL OF MATERIAL ON LAST PAGE

This drawing is confidential and must not be reproduced or used without the consent of EXM

Ce dessin est confidentiel et ne doit pas être reproduit ou utilisé sans le consentement de EXM

STANDARD FEATURES ARE NOT LISTED IN THIS HOLE TABLE

HOLE TABLE - FRONT VIEW (CUSTOM FEATURE ONLY)

CUT-OUT	XDIM	YDIM	DESCRIPTION
1	5.025	4.200	LOCK 880 SCQ1-SL @ 0.0°

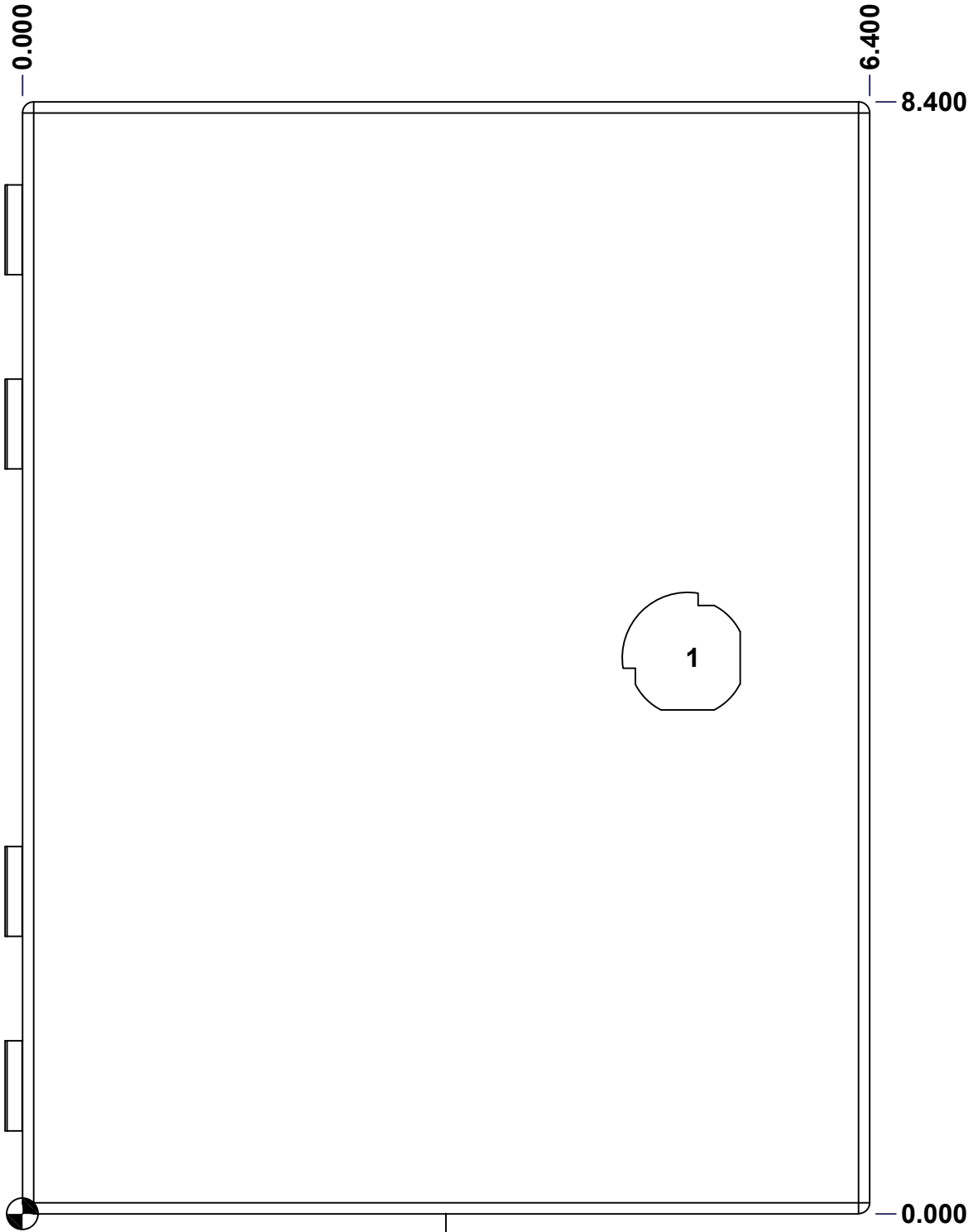

FRONT

	Description	Status
	1100EHN 8" x 6" Cover	(NULL)
	Part Number Numéro Pièce	Rev.
	1100EH080604NC	0 / 7 / 8

This drawing is confidential and must not be reproduced or used without the consent of EXM

Ce dessin est confidentiel et ne doit pas être reproduit ou utilisé sans le consentement de EXM

No.	Revisions	Date	By/Par

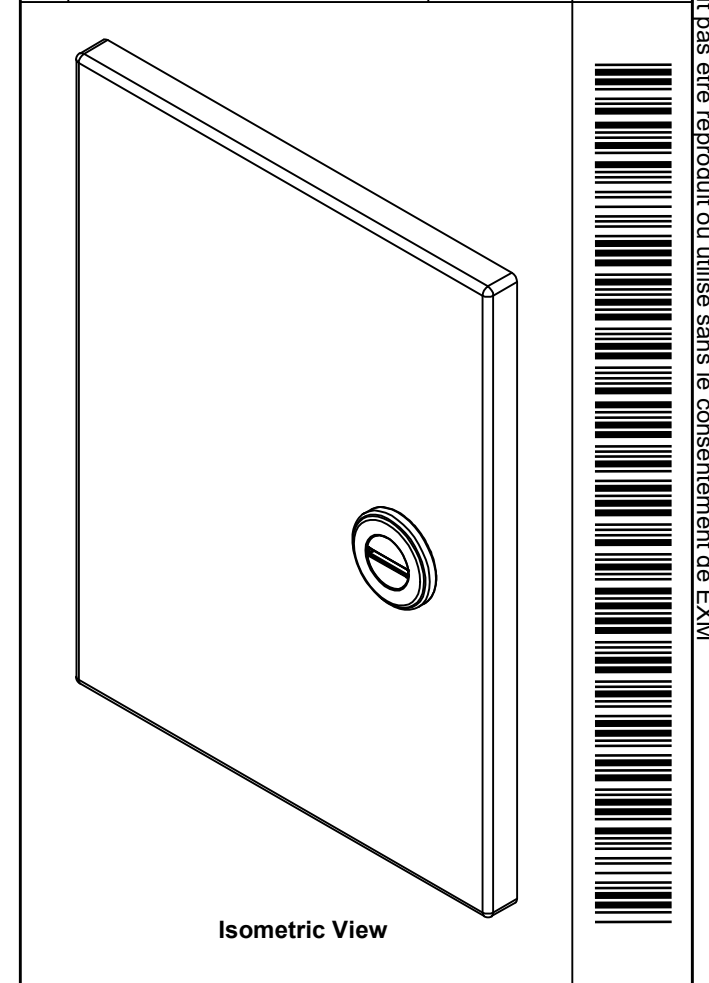

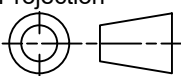
 Tél: (450) 979-4373 Fax: (450) 979-4626 www.exmweb.com		Flatness Aplatissement Max 3.0mm Projection 
Customer Client	Date	
Drawn By Dessiné Par	BoxCad: BoxCad	Date 03-Mar-26
Material Matière	16 Ga Cold Rolled A1008 CS Type B (1.4mm)	
Color Couleur	Asa-61 Grey	Finish Fini Smooth
Description		Detail Rev.
1100EHN 8" x 6" Cover		
Part Number Numéro Pièce	Rev.	8
1100EH080604NC	0	8

QTY	Part Number	Rev	Description
1	880 SCQ1-SL	0	1100 1/4 Turn Lock
1	STK-P-02400S	0	Powder Paint (Asa-61 Grey / Smooth)
1	STK-S-00900	0	UL Cut-Out Box Sticker
1	STK-S-00800	2	CSA Electrical Box Sticker
1	1100EH080604NC-P	0	1100EHN 8" x 6" x 4" Cover Part
Parts List			