

This drawing is confidential and must not be reproduced or used without the consent of EXM

Ce dessin est confidentiel et ne doit pas être reproduit ou utilisé sans le consentement de EXM

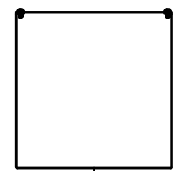

TOP

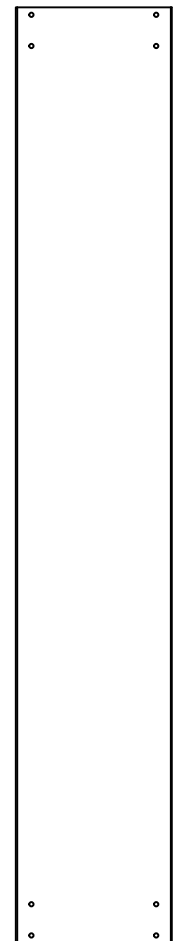

BACK

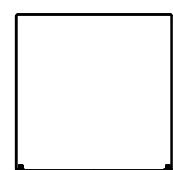

BOTTOM

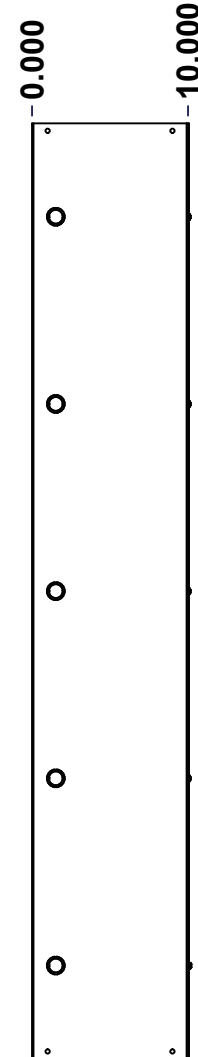

LEFT

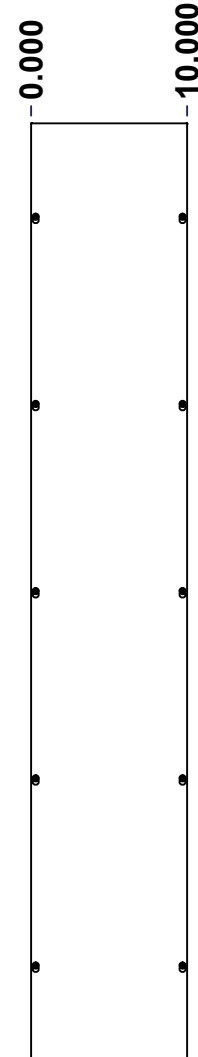

FRONT

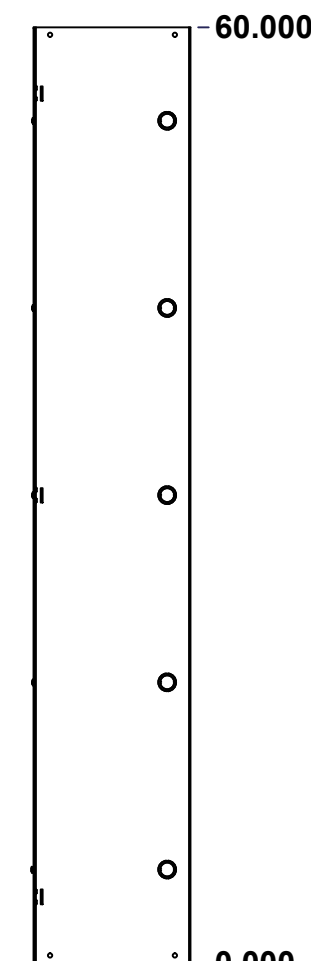

RIGHT

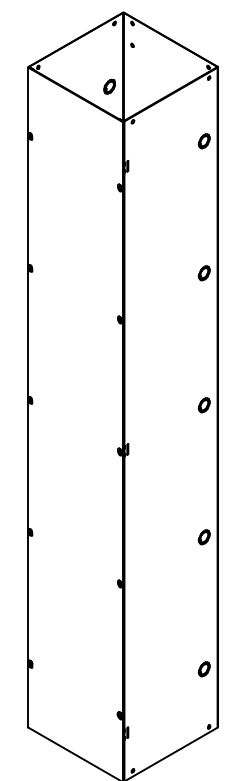

Isometric View



No.	Revisions	Date	By/Par



Tél: (450) 979-4373
 Fax: (450) 979-4626
www.exmweb.com

Flatness
Aplatissement
Max 3.0mm
Projection

Customer Client	Date
Drawn By Dessiné Par BoxCad: BoxCad	Date 27-Feb-24
Material Matière 16 Ga Cold Rolled A1008 CS Type B (1.4mm)	
Color Couleur Asa-61 Grey	Finish Fini Smooth
Description 1100SS 60" x 10" x 10" Assembly	Detail Rev.
Part Number Numéro Pièce 1100SS10060SC	Rev. 1 0

SEE BILL OF MATERIAL ON LAST PAGE

This drawing is confidential and must not be reproduced or used without the consent of EXM

Ce dessin est confidentiel et ne doit pas être reproduit ou utilisé sans le consentement de EXM

NOTE	
ITEM	DESCRIPTION
1	NEMA 1 Enclosure (IP20)

No.	Revisions	Date	By/Par

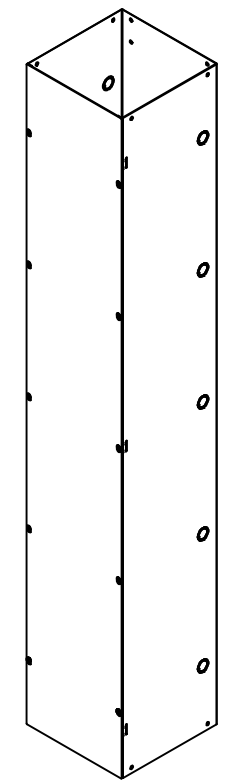

Isometric View

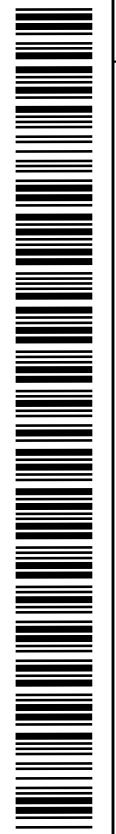

Tél: (450) 979-4373
 Fax: (450) 979-4626
www.exmweb.com



Customer Client	Date
Drawn By / Dessiné Par: BoxCad: BoxCad	Date: 27-Feb-24
Material / Matière: 16 Ga Cold Rolled A1008 CS Type B (1.4mm)	
Color / Couleur: Asa-61 Grey	Finish / Fini: Smooth

PACKING		
ITEM	QTY	DESCRIPTION
Cardboard sleeve	2	Top and Bottom
Plastic strap - Black	2	To Squeeze 2 cardboard sleeve together
Packaging label	3	White label with PN

Qty	Part Number	Rev	Description
10	STK-Q-05020	5	M5 x 8mm Thread Rolling Screw
1	1100SS10060SCC	0	1100SS 60" x 10" Cover
1	1100SS10060SCB	0	1100SS 60" x 10" x 10" Body

Parts List

Description: 1100SS 60" x 10" x 10" Assembly	Detail Rev.
Part Number / Numéro Pièce: 1100SS10060SC	Rev. 0

This drawing is confidential and must not be reproduced or used without the consent of EXM

Ce dessin est confidentiel et ne doit pas être reproduit ou utilisé sans le consentement de EXM

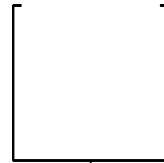

TOP

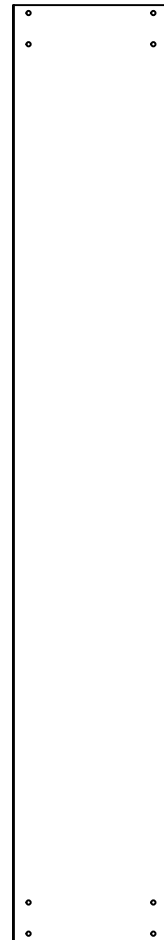

BACK

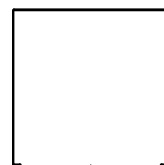

BOTTOM

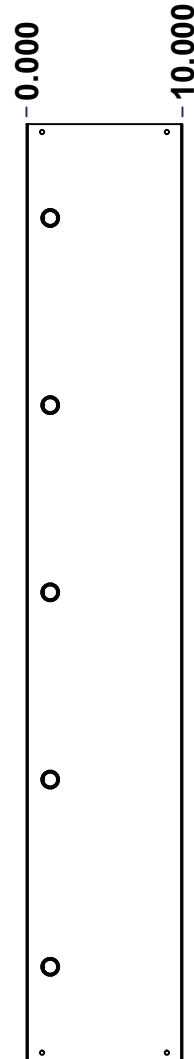

LEFT

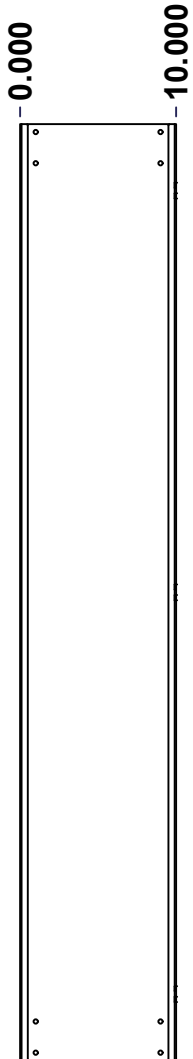

FRONT

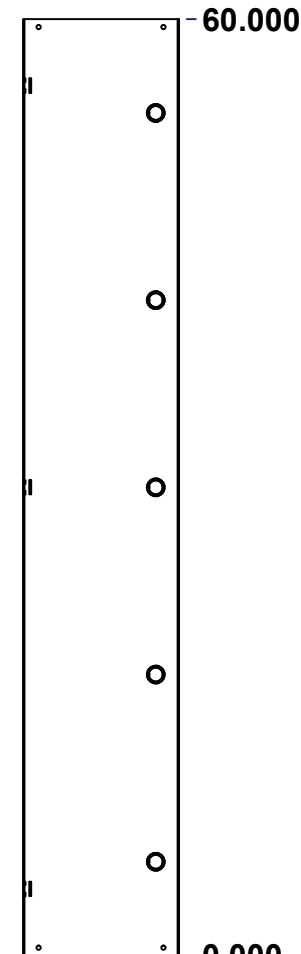

RIGHT

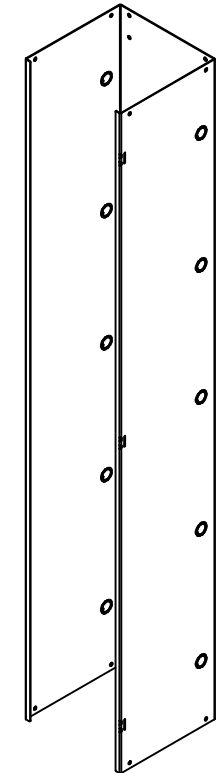

Isometric View

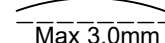

No.	Revisions	Date	By/Par

 Tél: (450) 979-4373 Fax: (450) 979-4626 www.exmweb.com		Flatness Aplatissement  Max 3.0mm
Customer Client		Date
Drawn By Dessiné Par BoxCad: BoxCad		Date 27-Feb-24
Material Matière 16 Ga Cold Rolled A1008 CS Type B (1.4mm)		
Color Couleur Asa-61 Grey	Finish Fini Smooth	
Description 1100SS 60" x 10" x 10" Body		Detail Rev.
Part Number Numéro Pièce 1100SS10060SCB		Rev. 3 0

SEE BILL OF MATERIAL ON LAST PAGE

This drawing is confidential and must not be reproduced or used without the consent of EXM

Ce dessin est confidentiel et ne doit pas être reproduit ou utilisé sans le consentement de EXM

No.	Revisions	Date	By/Par

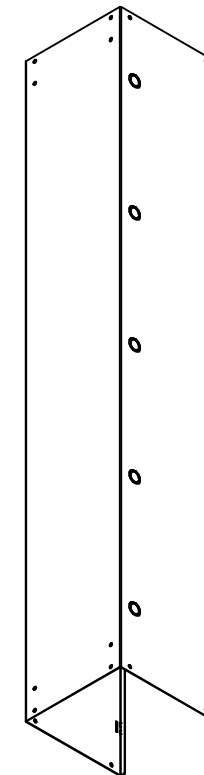

Isometric View

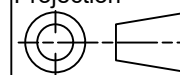

 Tél: (450) 979-4373 Fax: (450) 979-4626 www.exmweb.com	Flatness Aplatissement	Max 3.0mm
	Projection	
Customer Client	Date	
Drawn By Dessiné Par	BoxCad: BoxCad	Date 27-Feb-24
Material Matière	16 Ga Cold Rolled A1008 CS Type B (1.4mm)	
Color Couleur	Asa-61 Grey	Finish Fini Smooth
Description	Detail Rev.	
1100SS 60" x 10" x 10" Body		
Part Number Numéro Pièce	Rev. 0	4 / 6
1100SS10060SCB		

Qty	Part Number	Rev	Description
1	STK-P-02400S	0	Powder Paint (Asa-61 Grey / Smooth)
1	1100SS10060SCB-P	0	1100SS 60" x 10" x 10" Body Part
Parts List			

This drawing is confidential and must not be reproduced or used without the consent of EXM

Ce dessin est confidentiel et ne doit pas être reproduit ou utilisé sans le consentement de EXM

TOP

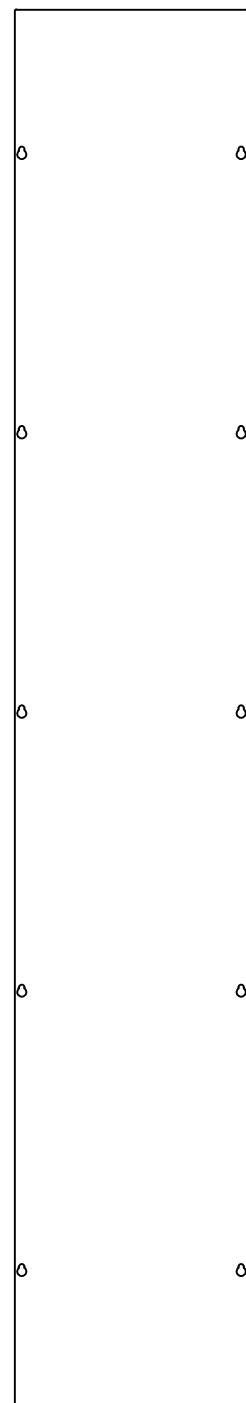

BACK

BOTTOM

LEFT

0.000 10.000

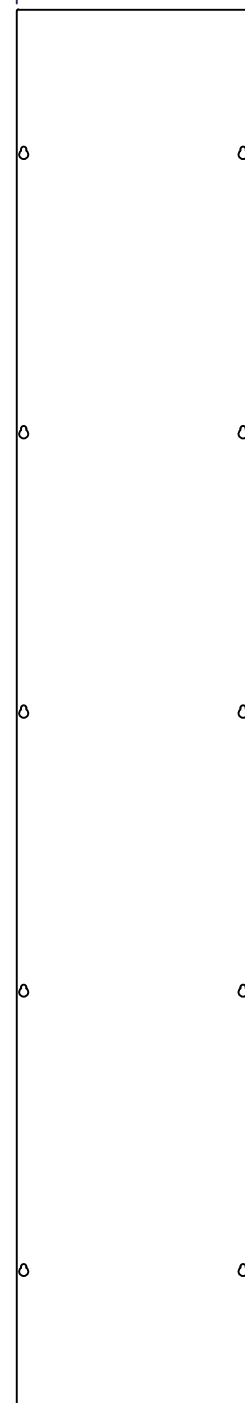

FRONT

60.000

RIGHT 0.000

No.	Revisions	Date	By/Par

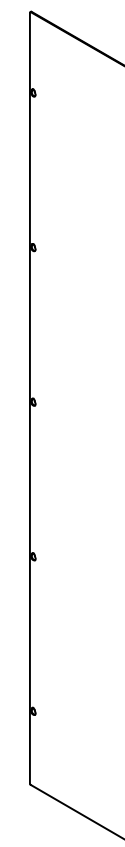

Isometric View



Tél: (450) 979-4373
 Fax: (450) 979-4626
www.exmweb.com

Flatness
Aplatissement

Max 3.0mm

Projection



Customer Client	Date
Drawn By / Dessiné Par: BoxCad: BoxCad	Date: 27-Feb-24
Material / Matière: 16 Ga Cold Rolled A1008 CS Type B (1.4mm)	

Color / Couleur: Asa-61 Grey	Finish / Fini: Smooth
------------------------------	-----------------------

Description: 1100SS 60" x 10" Cover	Detail Rev.
-------------------------------------	-------------

Part Number / Numéro Pièce: 1100SS10060SCC	Rev. 0	5	6
--	--------	---	---

SEE BILL OF MATERIAL ON LAST PAGE

This drawing is confidential and must not be reproduced or used without the consent of EXM

Ce dessin est confidentiel et ne doit pas être reproduit ou utilisé sans le consentement de EXM

No.	Revisions	Date	By/Par

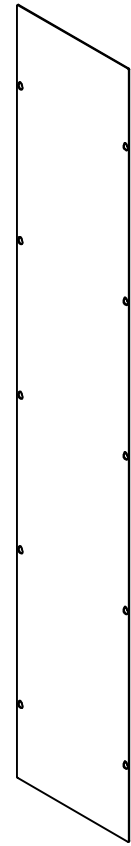

Isometric View

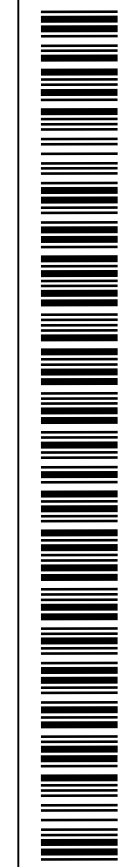

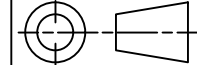
		Tél: (450) 979-4373 Fax: (450) 979-4626 www.exmweb.com		Flatness Aplatissement Max 3.0mm	
Projection 		Date 27-Feb-24			
Customer Client		Date			
Drawn By / Dessiné Par		BoxCad: BoxCad		Date	
Material / Matière		16 Ga Cold Rolled A1008 CS Type B (1.4mm)			
Color / Couleur		Asa-61 Grey		Finish / Fini Smooth	
Description				Detail Rev.	
1100SS 60" x 10" Cover				0	
Part Number / Numéro Pièce				Rev.	
1100SS10060SCC				0	

Qty	Part Number	Rev	Description
1	1100SS10060SCC-P	0	1100SS 60" x 10" Cover Part
1	STK-P-02400S	0	Powder Paint (Asa-61 Grey / Smooth)
Parts List			