

This drawing is confidential and must not be reproduced or used without the consent of EXM

Ce dessin est confidentiel et ne doit pas être reproduit ou utilisé sans le consentement de EXM

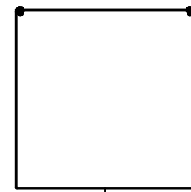

TOP

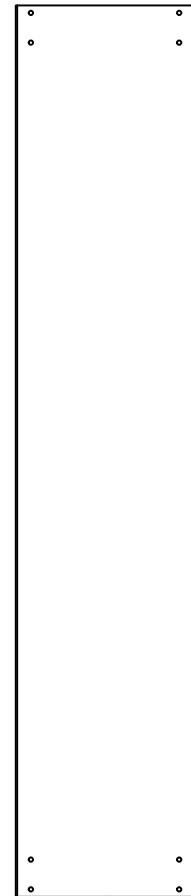

BACK

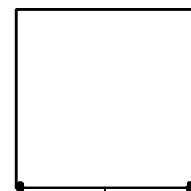

BOTTOM

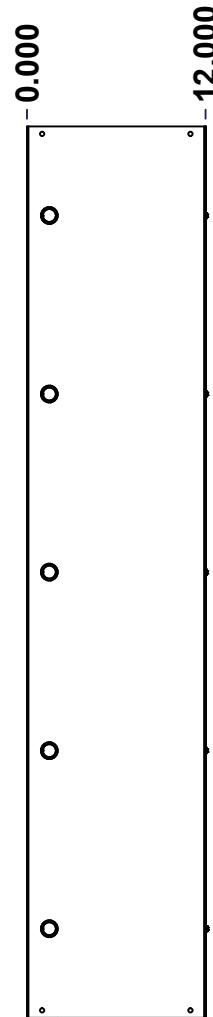

LEFT

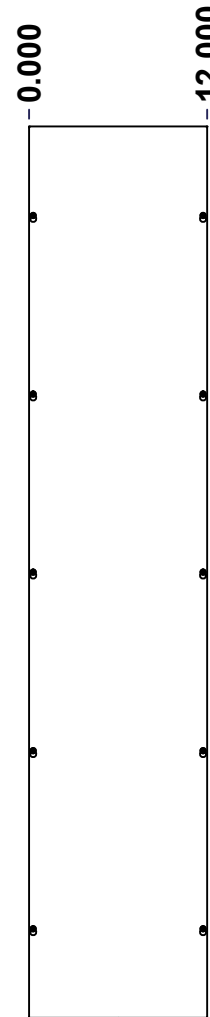

FRONT

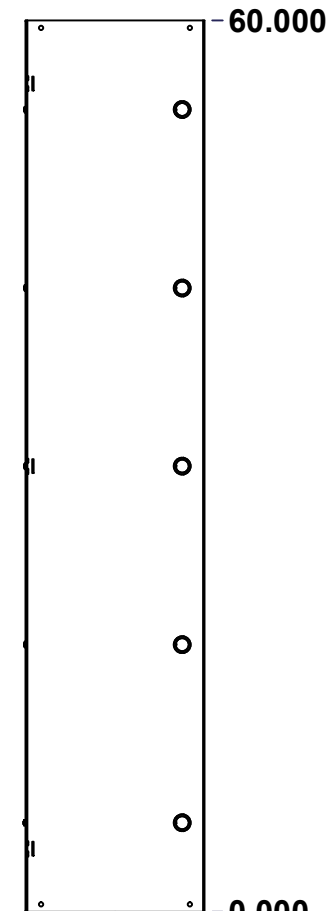

RIGHT

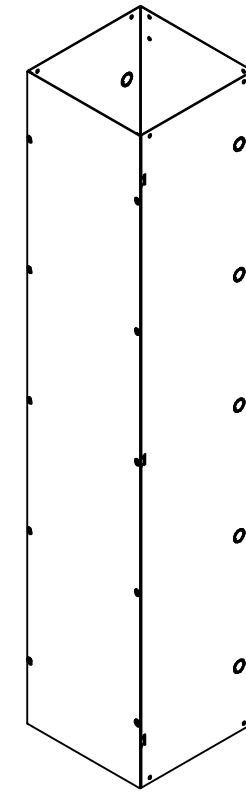

Isometric View

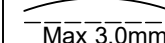
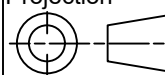

| No. | Revisions | Date | By/Par |
|-----|-----------|------|--------|
|     |           |      |        |
|     |           |      |        |
|     |           |      |        |
|     |           |      |        |

|  |   |  |
|--|---|--|
|  Tél: (450) 979-4373<br>Fax: (450) 979-4626<br><a href="http://www.exmweb.com">www.exmweb.com</a> |   | Flatness<br>Aplatissement<br><br>Max 3.0mm<br>Projection<br> |
| Customer<br>Client   |   | Date   |
| Drawn By<br>Dessiné Par  | BoxCad: BoxCad                            | Date 27-Feb-24   |
| Material<br>Matière  | 16 Ga Cold Rolled A1008 CS Type B (1.4mm) |  |
| Color<br>Couleur   | Asa-61 Grey                               | Finish<br>Fini Smooth  |
| Description<br>1100SS 60" x 12" x 12" Assembly   |   | Detail Rev.  |
| Part Number<br>Numéro Pièce<br><b>1100SS12060SC</b>  |   | Rev. 1<br><b>0</b>   |

SEE BILL OF MATERIAL ON LAST PAGE

6

This drawing is confidential and must not be reproduced or used without the consent of EXM

Ce dessin est confidentiel et ne doit pas être reproduit ou utilisé sans le consentement de EXM

| NOTE |                         |
|------|-------------------------|
| ITEM | DESCRIPTION             |
| 1    | NEMA 1 Enclosure (IP20) |

| No. | Revisions | Date | By/Par |
|-----|-----------|------|--------|
|     |           |      |        |
|     |           |      |        |
|     |           |      |        |
|     |           |      |        |

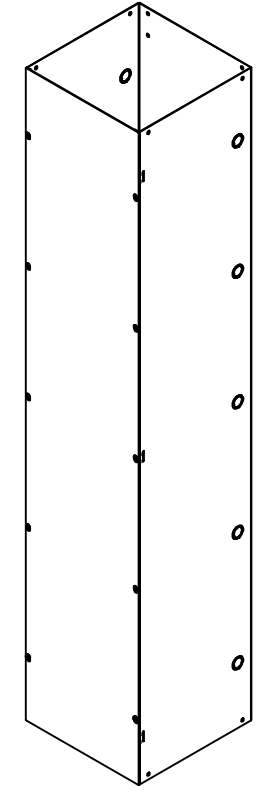

Isometric View



Tél: (450) 979-4373  
 Fax: (450) 979-4626  
[www.exmweb.com](http://www.exmweb.com)



|   |                       |
|---|-----------------------|
| Customer Client   | Date                  |
| Drawn By / Dessiné Par: BoxCad: BoxCad                        | Date: 27-Feb-24       |
| Material / Matière: 16 Ga Cold Rolled A1008 CS Type B (1.4mm) |                       |
| Color / Couleur: Asa-61 Grey                                  | Finish / Fini: Smooth |

| PACKING               |     |  |
|-----------------------|-----|--|
| ITEM                  | QTY | DESCRIPTION                            |
| Cardboard sleeve      | 2   | Top and Bottom                         |
| Plastic strap - Black | 2   | To Squeeze 2 cardboard sleeve together |
| Packaging label       | 3   | White label with PN                    |

|            |                |     |                               |
|------------|----------------|-----|-------------------------------|
| 10         | STK-Q-05020    | 5   | M5 x 8mm Thread Rolling Screw |
| 1          | 1100SS12060SCC | 0   | 1100SS 60" x 12" Cover        |
| 1          | 1100SS12060SCB | 0   | 1100SS 60" x 12" x 12" Body   |
| Qty        | Part Number    | Rev | Description                   |
| Parts List |                |     |                               |

|  |             |
|--|-------------|
| Description: 1100SS 60" x 12" x 12" Assembly     | Detail Rev. |
| Part Number / Numéro Pièce: <b>1100SS12060SC</b> | Rev. 0      |

This drawing is confidential and must not be reproduced or used without the consent of EXM

Ce dessin est confidentiel et ne doit pas être reproduit ou utilisé sans le consentement de EXM

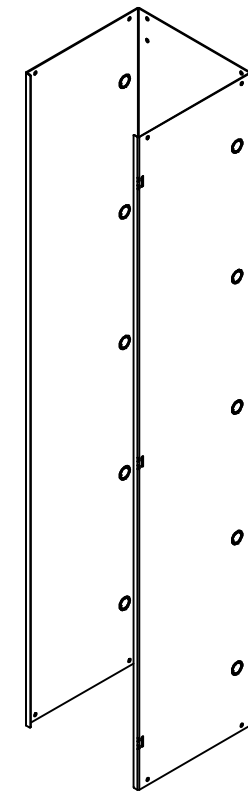
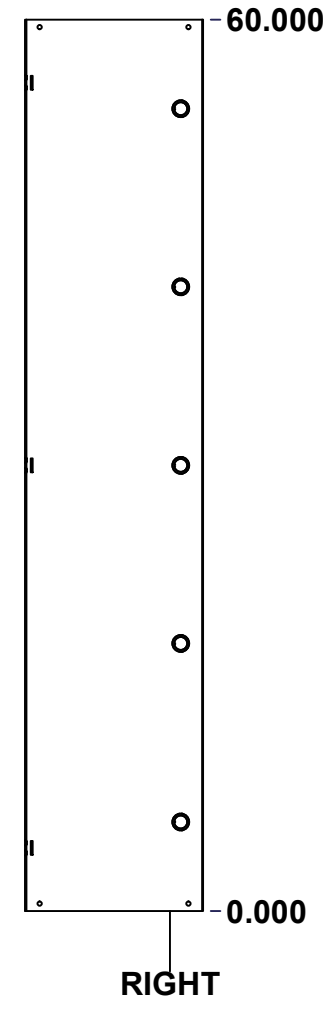
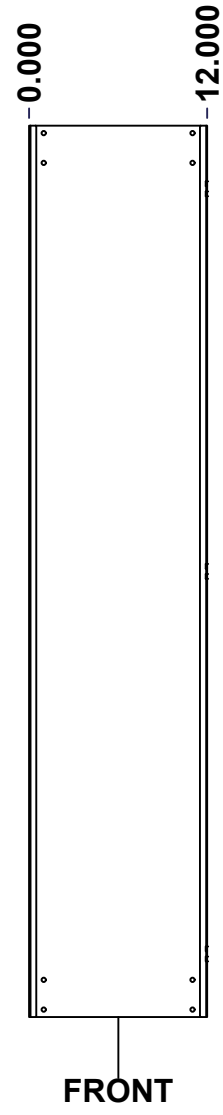
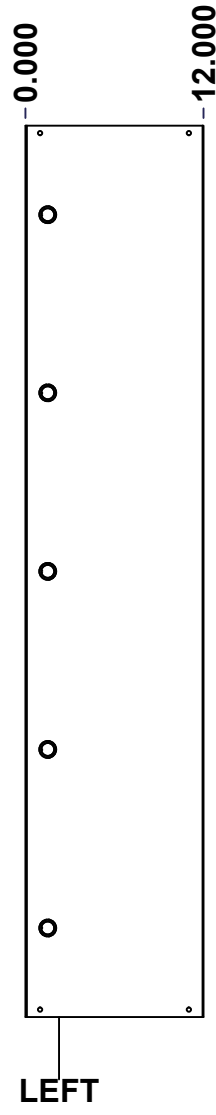
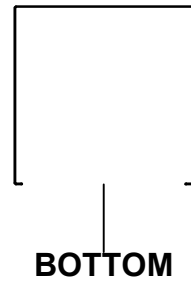
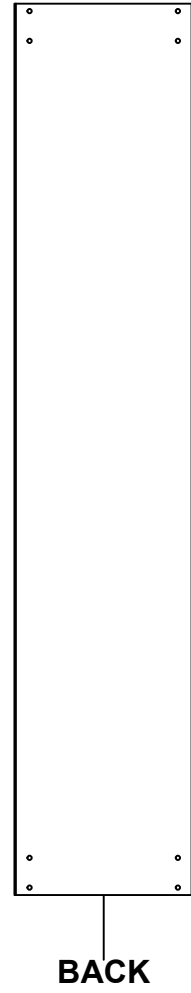
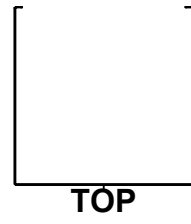

| No. | Revisions | Date | By/Par |
|-----|-----------|------|--------|
|     |           |      |        |
|     |           |      |        |
|     |           |      |        |
|     |           |      |        |
|     |           |      |        |

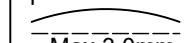
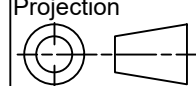
|  |   |  |
|--|---|--|
|  Tél: (450) 979-4373<br>Fax: (450) 979-4626<br><a href="http://www.exmweb.com">www.exmweb.com</a> |   | Flatness<br>Aplatissement<br><br>Max 3.0mm<br>Projection<br> |
| Customer<br>Client   | Date                                      |  |
| Drawn By<br>Dessiné Par  | BoxCad: BoxCad                            | Date 27-Feb-24   |
| Material<br>Matière  | 16 Ga Cold Rolled A1008 CS Type B (1.4mm) |  |
| Color<br>Couleur   | Asa-61 Grey                               | Finish<br>Fini Smooth  |
| Description<br>1100SS 60" x 12" x 12" Body   |   | Detail Rev.  |
| Part Number<br>Numéro Pièce  | Rev. 0                                    | 3<br>6   |

**SEE BILL OF MATERIAL ON LAST PAGE**

**1100SS12060SCB**

This drawing is confidential and must not be reproduced or used without the consent of EXM

Ce dessin est confidentiel et ne doit pas être reproduit ou utilisé sans le consentement de EXM

| No. | Revisions | Date | By/Par |
|-----|-----------|------|--------|
|     |           |      |        |
|     |           |      |        |
|     |           |      |        |
|     |           |      |        |
|     |           |      |        |

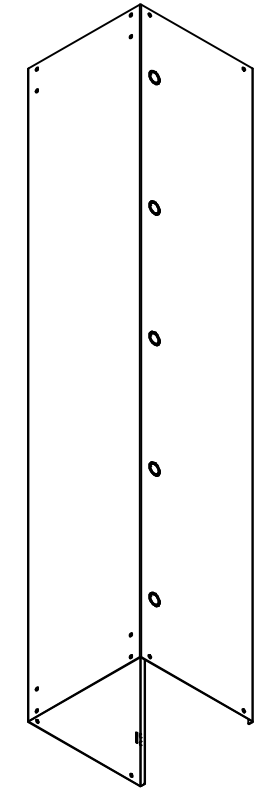

Isometric View

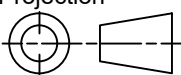

|  |   |   |
|--|---|---|
|  Tél: (450) 979-4373<br>Fax: (450) 979-4626<br><a href="http://www.exmweb.com">www.exmweb.com</a> | Flatness<br>Aplatissement                 | Max 3.0mm   |
|  | Projection                                |  |
| Customer<br>Client   | Date                                      |   |
| Drawn By<br>Dessiné Par  | BoxCad: BoxCad                            | Date 27-Feb-24  |
| Material<br>Matière  | 16 Ga Cold Rolled A1008 CS Type B (1.4mm) |   |
| Color<br>Couleur   | Asa-61 Grey                               | Finish<br>Fini Smooth   |
| Description  | Detail Rev.                               |   |
| 1100SS 60" x 12" x 12" Body  |   |   |
| Part Number<br>Numéro Pièce  | Rev.                                      | 4   |
| <b>1100SS12060SCB</b>  | <b>0</b>                                  | 6   |

| Qty        | Part Number      | Rev | Description                         |
|------------|------------------|-----|-------------------------------------|
| 1          | STK-P-02400S     | 0   | Powder Paint (Asa-61 Grey / Smooth) |
| 1          | 1100SS12060SCB-P | 0   | 1100SS 60" x 12" x 12" Body Part    |
| Parts List |                  |     |                                     |

This drawing is confidential and must not be reproduced or used without the consent of EXM

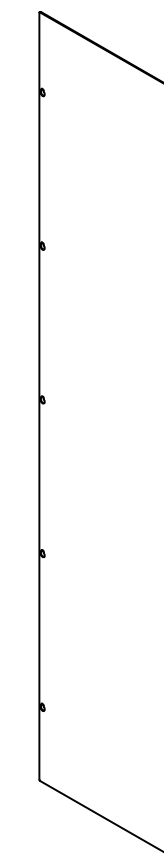
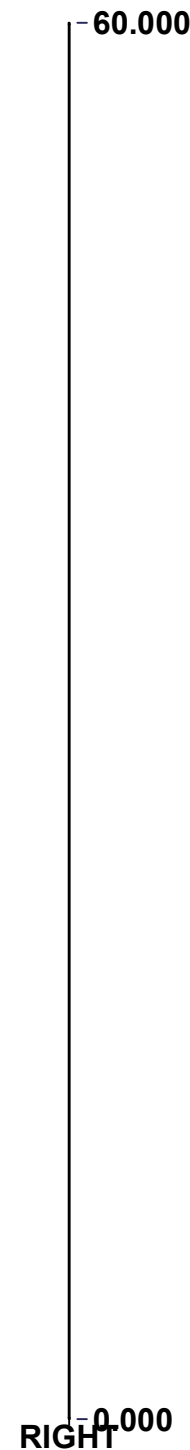
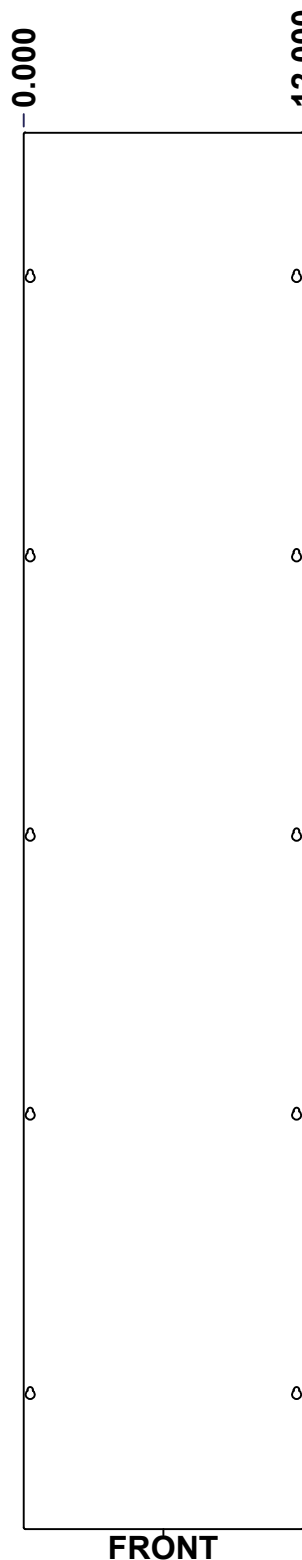
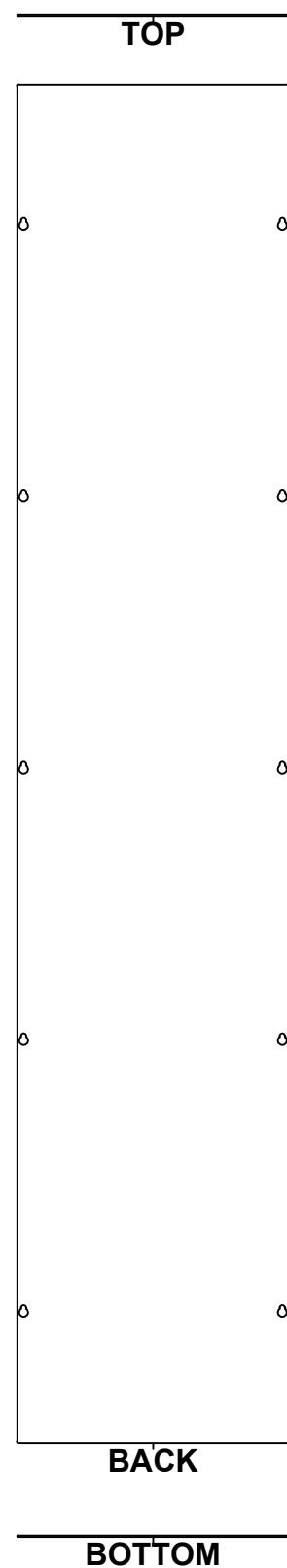

Ce dessin est confidentiel et ne doit pas être reproduit ou utilisé sans le consentement de EXM



Isometric View

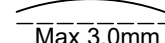

| No. | Revisions | Date | By/Par |
|-----|-----------|------|--------|
|     |           |      |        |
|     |           |      |        |
|     |           |      |        |
|     |           |      |        |
|     |           |      |        |

|  |   |  |
|--|---|--|
|  Tél: (450) 979-4373<br>Fax: (450) 979-4626<br><a href="http://www.exmweb.com">www.exmweb.com</a> |   | Flatness<br>Aplatissement<br><br>Max 3.0mm<br>Projection<br> |
| Customer Client  | Date                                      |  |
| Drawn By<br>Dessiné Par  | BoxCad: BoxCad                            | Date 27-Feb-24   |
| Material<br>Matière  | 16 Ga Cold Rolled A1008 CS Type B (1.4mm) |  |
| Color<br>Couleur   | Asa-61 Grey                               | Finish<br>Fini Smooth  |
| Description<br>1100SS 60" x 12" Cover  |   | Detail Rev.  |
| Part Number<br>Numéro Pièce  | Rev. 0                                    | 5<br>6   |

SEE BILL OF MATERIAL ON LAST PAGE

**1100SS12060SCC**

This drawing is confidential and must not be reproduced or used without the consent of EXM

Ce dessin est confidentiel et ne doit pas être reproduit ou utilisé sans le consentement de EXM

| No. | Revisions | Date | By/Par |
|-----|-----------|------|--------|
|     |           |      |        |
|     |           |      |        |
|     |           |      |        |
|     |           |      |        |
|     |           |      |        |

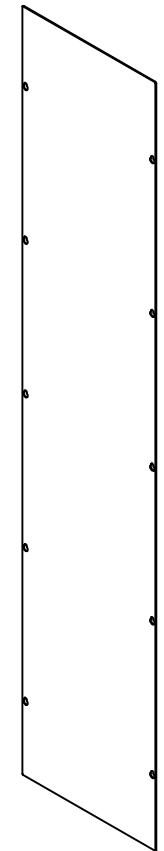

Isometric View

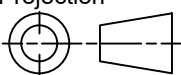

|  |                       |   |
|--|-----------------------|---|
|  Tél: (450) 979-4373<br>Fax: (450) 979-4626<br><a href="http://www.exmweb.com">www.exmweb.com</a> |                       | Flatness<br>Aplatissement<br>Max 3.0mm  |
| Customer Client  |                       | Projection<br> |
| Drawn By / Dessiné Par: BoxCad: BoxCad   |                       | Date: 27-Feb-24   |
| Material / Matière: 16 Ga Cold Rolled A1008 CS Type B (1.4mm)  |                       |   |
| Color / Couleur: Asa-61 Grey   | Finish / Fini: Smooth |   |
| Description: 1100SS 60" x 12" Cover  |                       | Detail Rev.   |
| Part Number / Numéro Pièce: <b>1100SS12060SCC</b>  |                       | Rev. 6<br><b>0</b>  |

| Qty        | Part Number      | Rev | Description                         |
|------------|------------------|-----|-------------------------------------|
| 1          | 1100SS12060SCC-P | 0   | 1100SS 60" x 12" Cover Part         |
| 1          | STK-P-02400S     | 0   | Powder Paint (Asa-61 Grey / Smooth) |
| Parts List |                  |     |                                     |