

This drawing is confidential and must not be reproduced or used without the consent of EXM

All knockouts are actual size / Les disques défonçables sont grandeur réel
 All dimensions are before paint / Toutes les dimensions sont avant peinture

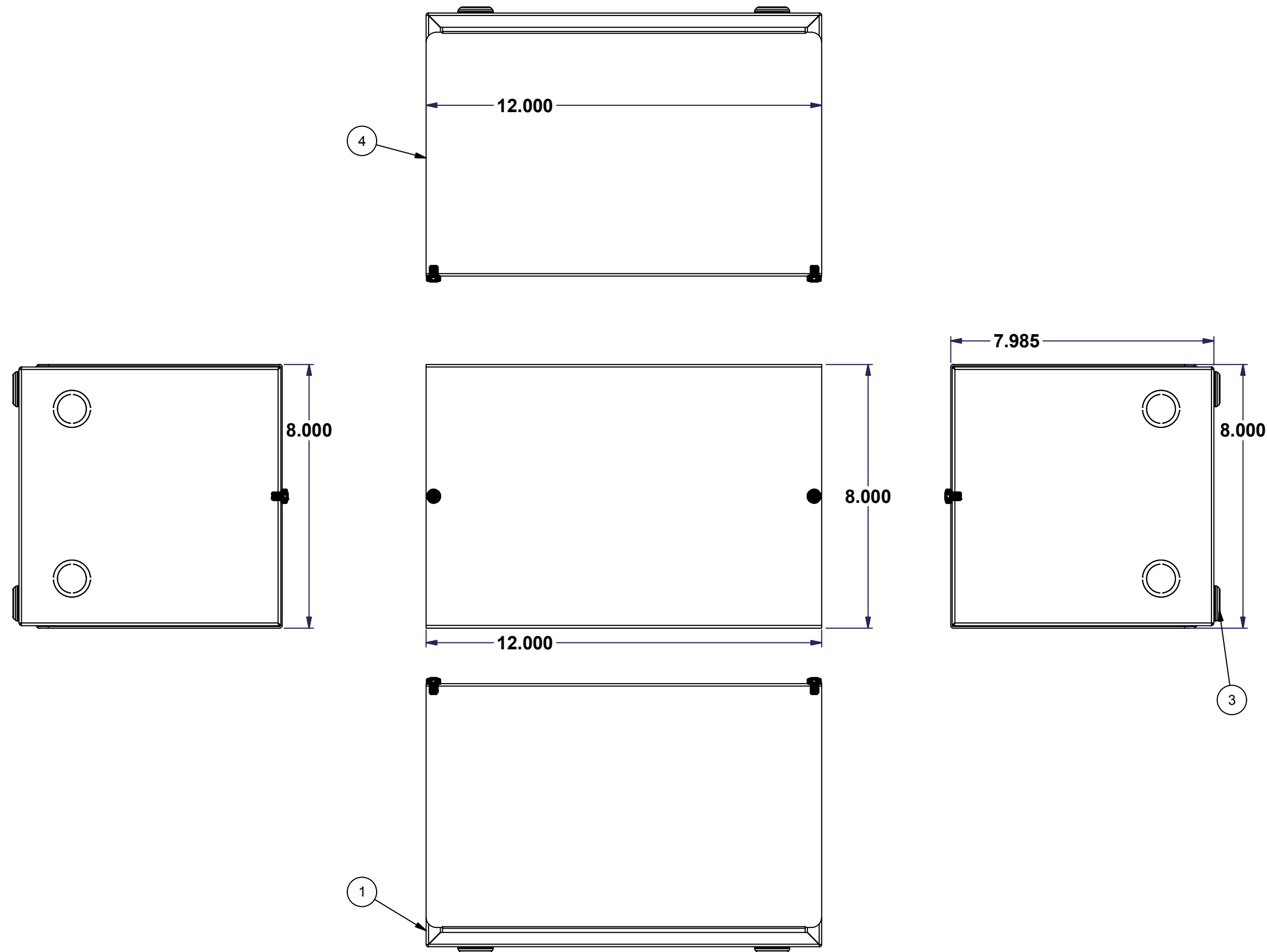

No.	Revisions	Date	By/Par
1	Update Model	02-Oct-08	MichelP
2	Turn into iLogic	7/7/2010	AllenL
2.1.0	Change all Material to 18Ga Cold Rolled Steel except vented cover	8/18/2010	AllenL

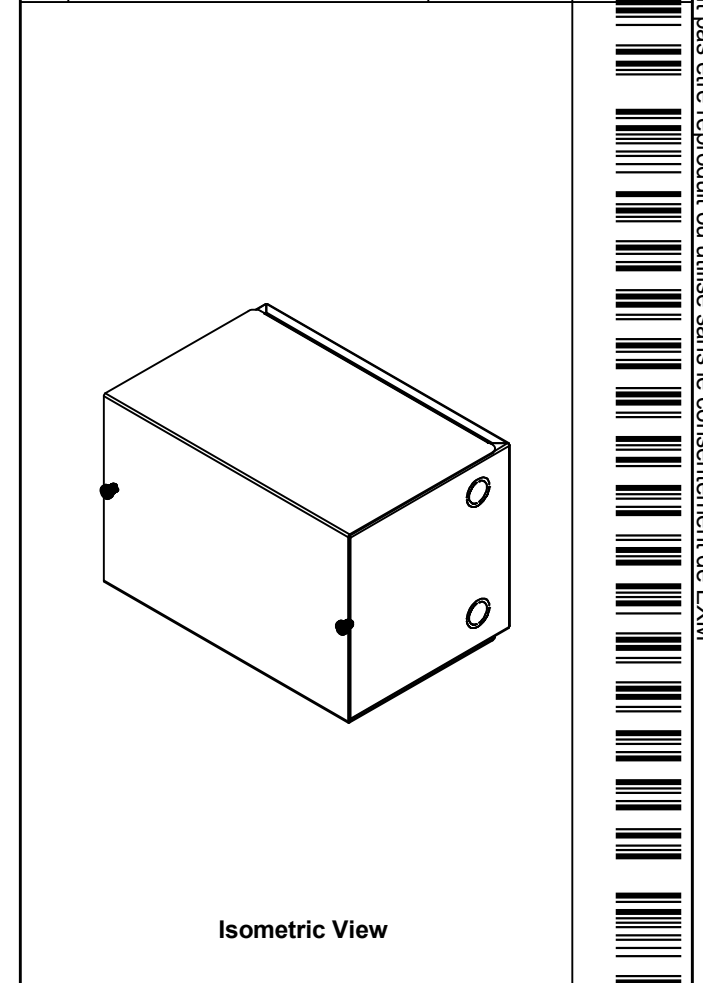

Ce dessin est confidentiel et ne doit pas être reproduit ou utilisé sans le consentement de EXM

Tél: (450) 979-4373 Fax: (450) 979-4626 www.exmweb.com		Flatness Aplatissement Max 3.0mm Projection
Customer Client	Date	
Drawn By / Dessiné Par: MichaelA	Date: 23-Mar-15	
Material / Matière	See Part List	
Color / Couleur	See Part List	Finish / Fini: See Part List
Description: 1100VE 12" x 8" x 8" Non-Ventilated Enclosure Assembly		Detail Rev.
Part Number / Numéro Pièce: 1100VE120808N		Rev. 2

Item	Qty	Part Number	Rev	Description	Material	Color	Finish
1	1	1100VE120808B-P	2	1100VE 12" x 8" x 8" Ventilated Enclosure Body Part		See Part List	See Part List
2	1	STK-K-01810	0	1100VE Accessory Kit		See Part List	See Part List
3	4	STK-Q-67600	1	Bumper	Rubber	BLACK	N/A
4	1	1100VE120808NC-P	2	1100VE 12" x 8" x 8" Non-Ventilated Enclosure Cover Part		See Part List	See Part List