

This drawing is confidential and must not be reproduced or used without the consent of EXM

Ce dessin est confidentiel et ne doit pas être reproduit ou utilisé sans le consentement de EXM

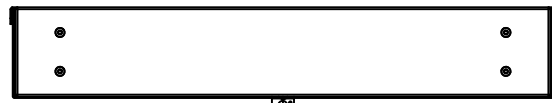

TOP



BACK

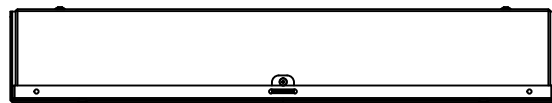

BOTTOM

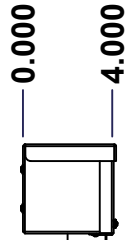

LEFT

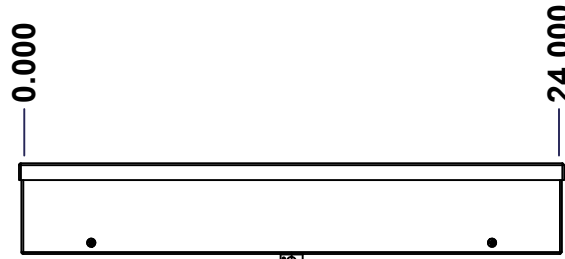

FRONT



RIGHT

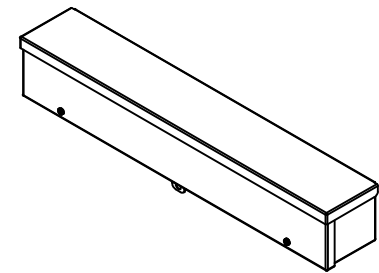

Isometric View

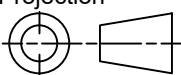

No.	Revisions	Date	By/Par

 Tél: (450) 979-4373 Fax: (450) 979-4626 <a href="http://www.exmweb.com">www.exmweb.com</a>		Flatness Aplatissement Max 3.0mm Projection 
Customer Client	Date	
Drawn By Dessiné Par	BoxCad: BoxCad	Date 21-Jan-22
Material Matière	16 Ga Galvannealed Steel (1.4mm)	
Color Couleur	Asa-61 Grey	Finish Fini Smooth
Description	Detail Rev.	
1300CH 4" x 24" x 4" Assembly		
Part Number Numéro Pièce	Rev.	1
1300CH040424	0	6

SEE BILL OF MATERIAL ON LAST PAGE

This drawing is confidential and must not be reproduced or used without the consent of EXM

Ce dessin est confidentiel et ne doit pas être reproduit ou utilisé sans le consentement de EXM

NOTE	
ITEM	DESCRIPTION
1	NEMA 3/3R Enclosure (IP64)
2	W/O Standard door stiffener
3	W/O Inner panel
4	W/O Inner panel mounting standoffs

No.	Revisions	Date	By/Par

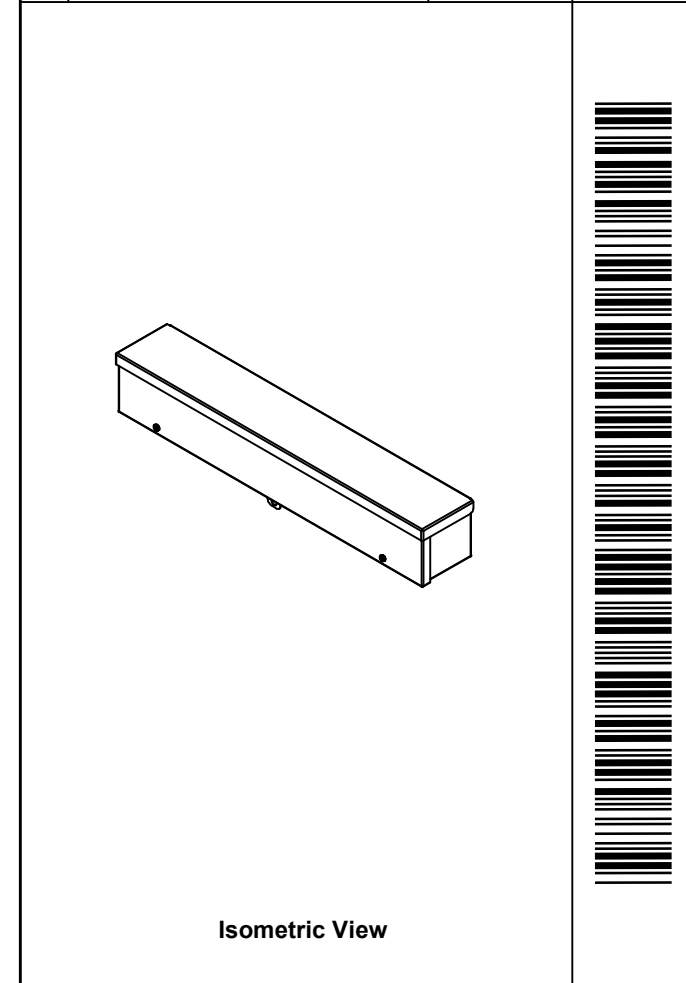

 Tél: (450) 979-4373  
 Fax: (450) 979-4626  
[www.exmweb.com](http://www.exmweb.com)

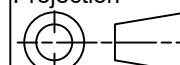
Flatness  
 Aplatissement  
 Max 3.0mm  
 Projection  

Customer Client	Date
Drawn By / Dessiné Par: BoxCad: BoxCad	Date: 21-Jan-22
Material / Matière: 16 Ga Galvannealed Steel (1.4mm)	
Color / Couleur: Asa-61 Grey	Finish / Fini: Smooth

PACKING		
ITEM	QTY	DESCRIPTION
Thermal plastic film	1	Use with Packing Tunnel Wrapper Machine
Packaging label	1	White label with product number

Qty	Part Number	Rev	Description
1	STK-K-03100	3	1300 CH - Accessory Kit
1	1300CH040424C	0	1300CH 4" x 24" Cover
1	1300CH040424B	0	1300CH 4" x 24" x 4" Body
Parts List			

Description: 1300CH 4" x 24" x 4" Assembly	Detail Rev.
Part Number / Numéro Pièce: <b>1300CH040424</b>	Rev. 0 / 2 / 6

This drawing is confidential and must not be reproduced or used without the consent of EXM

Ce dessin est confidentiel et ne doit pas être reproduit ou utilisé sans le consentement de EXM

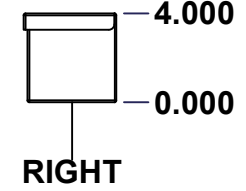
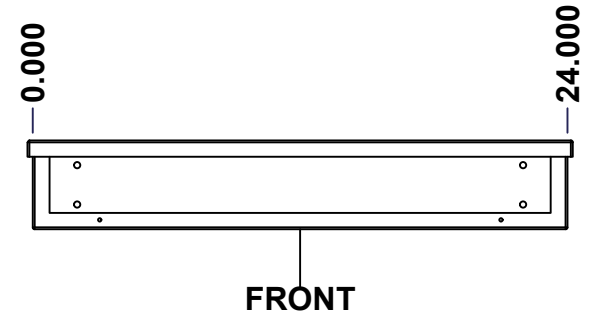
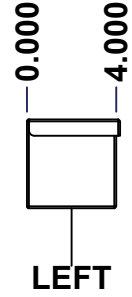
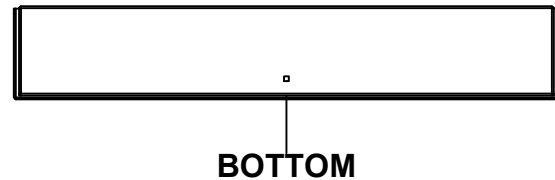
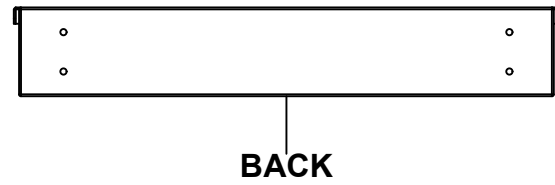
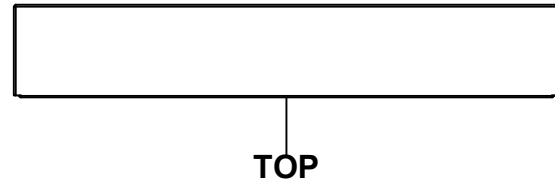

No.	Revisions	Date	By/Par

**Isometric View**

Tél: (450) 979-4373 Fax: (450) 979-4626 <a href="http://www.exmweb.com">www.exmweb.com</a>		Flatness Aplatissement Max 3.0mm Projection 
Customer Client	Date	
Drawn By Dessiné Par	BoxCad: BoxCad	Date 21-Jan-22
Material Matière	16 Ga Galvannealed Steel (1.4mm)	
Color Couleur	Asa-61 Grey	Finish Fini Smooth
Description	Detail Rev.	
1300CH 4" x 24" x 4" Body		
Part Number Numéro Pièce	Rev.	3
<b>1300CH040424B</b>	<b>0</b>	6

**SEE BILL OF MATERIAL ON LAST PAGE**

This drawing is confidential and must not be reproduced or used without the consent of EXM

Ce dessin est confidentiel et ne doit pas être reproduit ou utilisé sans le consentement de EXM

No.	Revisions	Date	By/Par

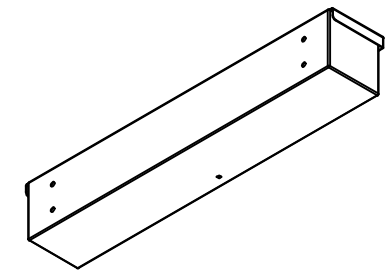

Isometric View

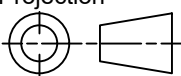

 Tél: (450) 979-4373 Fax: (450) 979-4626 <a href="http://www.exmweb.com">www.exmweb.com</a>	Flatness Aplatissement	Max 3.0mm
	Projection	
Customer Client	Date	
Drawn By Dessiné Par	BoxCad: BoxCad	Date 21-Jan-22
Material Matière	16 Ga Galvannealed Steel (1.4mm)	
Color Couleur	Asa-61 Grey	Finish Fini Smooth
Description	Detail Rev.	
1300CH 4" x 24" x 4" Body		
Part Number Numéro Pièce	Rev.	4
<b>1300CH040424B</b>	<b>0</b>	6

Qty	Part Number	Rev	Description
1	STK-P-02400S	0	Powder Paint (Asa-61 Grey / Smooth)
1	1300CH040424B-P	0	1300CH 4" x 24" Body Part
Parts List			

This drawing is confidential and must not be reproduced or used without the consent of EXM

Ce dessin est confidentiel et ne doit pas être reproduit ou utilisé sans le consentement de EXM

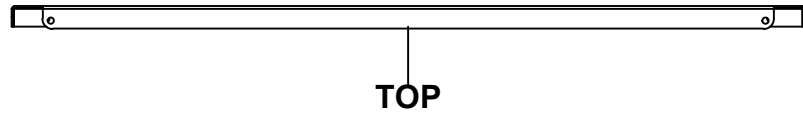

TOP

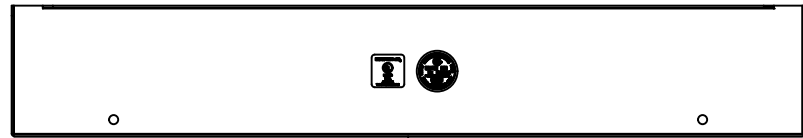

BACK

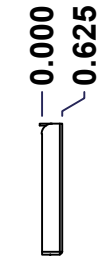

LEFT

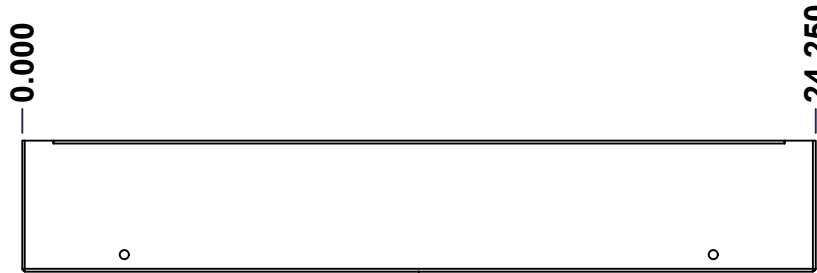

FRONT

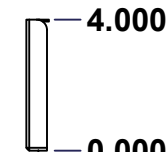

RIGHT



BOTTOM

No.	Revisions	Date	By/Par

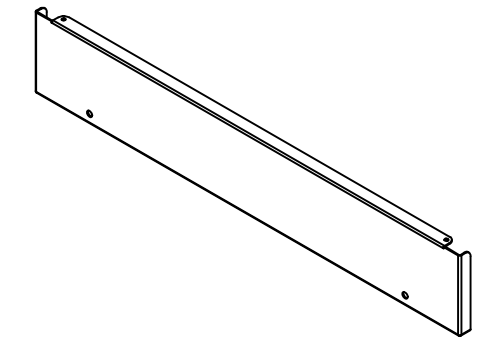

Isometric View



Tél: (450) 979-4373  
 Fax: (450) 979-4626  
[www.exmweb.com](http://www.exmweb.com)

Flatness  
Aplatissement

Max 3.0mm

Projection

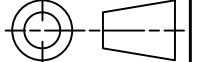

Customer Client	Date
Drawn By / Dessiné Par: BoxCad: BoxCad	Date: 21-Jan-22
Material / Matière: 16 Ga Galvannealed Steel (1.4mm)	
Color / Couleur: Asa-61 Grey	Finish / Fini: Smooth
Description: 1300CH 4" x 24" Cover	Detail Rev.
Part Number / Numéro Pièce: 1300CH040424C	Rev. 0

SEE BILL OF MATERIAL ON LAST PAGE

This drawing is confidential and must not be reproduced or used without the consent of EXM

Ce dessin est confidentiel et ne doit pas être reproduit ou utilisé sans le consentement de EXM

No.	Revisions	Date	By/Par

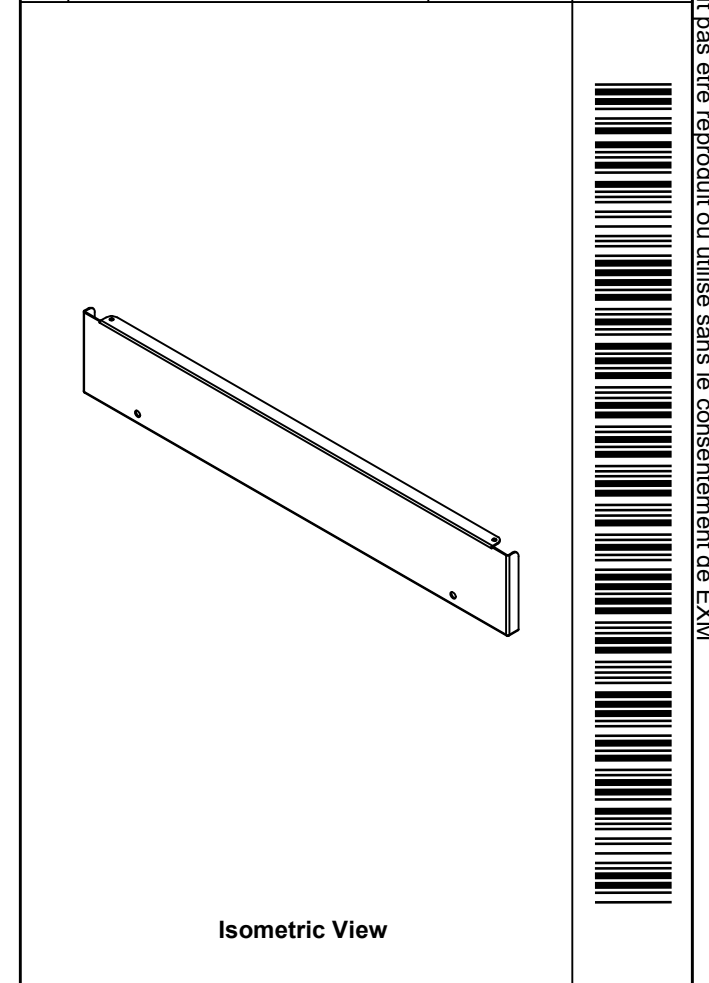

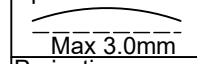
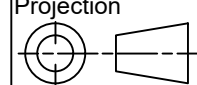
 Tél: (450) 979-4373 Fax: (450) 979-4626 <a href="http://www.exmweb.com">www.exmweb.com</a>		Flatness Aplatissement  Max 3.0mm Projection 
Customer Client	Date	
Drawn By / Dessiné Par: BoxCad: BoxCad	Date: 21-Jan-22	
Material / Matière: 16 Ga Galvannealed Steel (1.4mm)		
Color / Couleur: Asa-61 Grey	Finish / Fini: Smooth	
Description: 1300CH 4" x 24" Cover		Detail Rev.
Part Number / Numéro Pièce: <b>1300CH040424C</b>	Rev.: <b>0</b>	6 / 6

QTY	Part Number	Rev	Description
1	STK-S-00950	1	UL 74SL Pull-Box Sticker
1	STK-S-00800	2	CSA Electrical Box Sticker
1	STK-P-02400S	0	Powder Paint (Asa-61 Grey / Smooth)
1	1300CH040424C-P	0	1300CH 4" x 24" Cover Part
Parts List			