

This drawing is confidential and must not be reproduced or used without the consent of EXM

Ce dessin est confidentiel et ne doit pas être reproduit ou utilisé sans le consentement de EXM

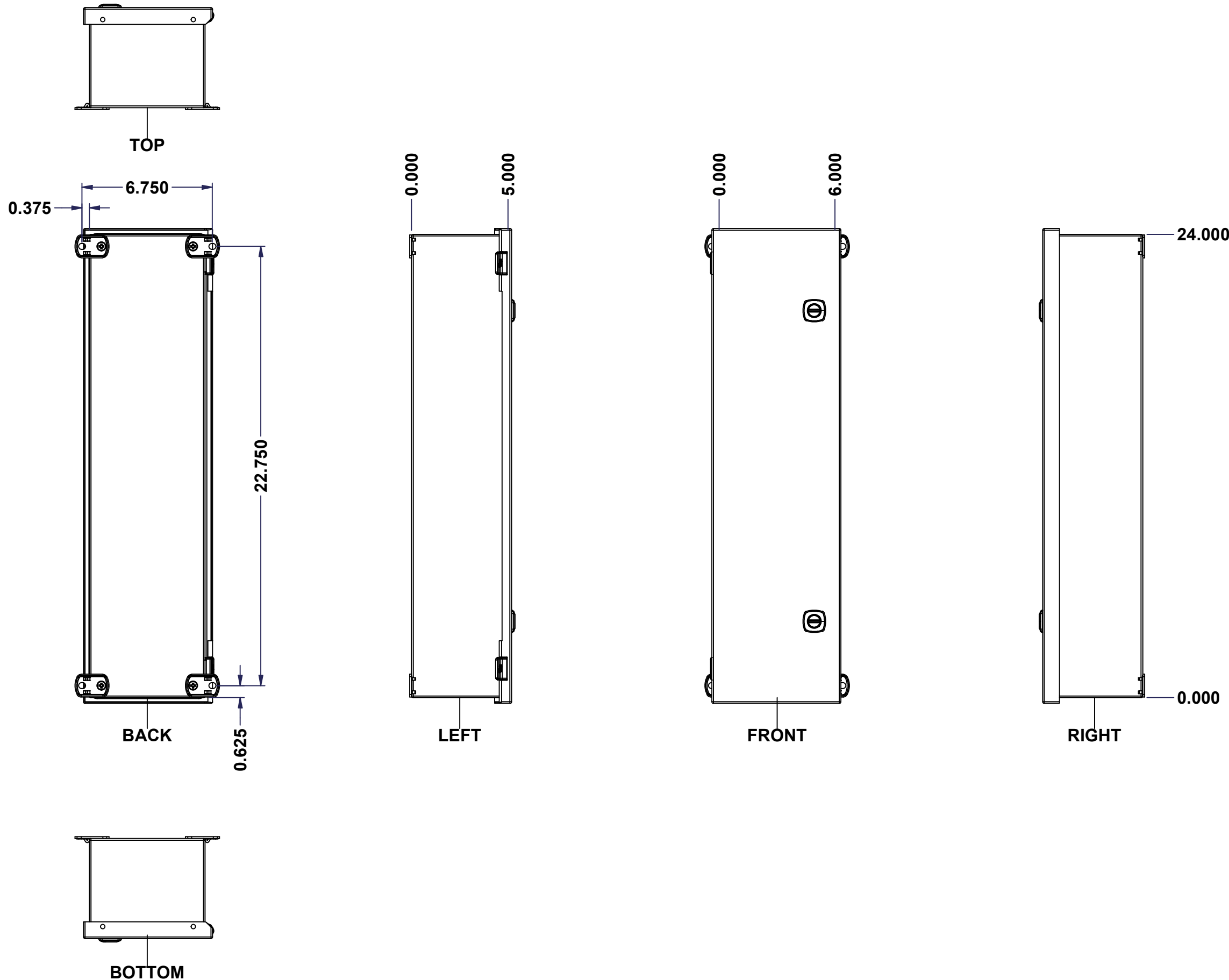

No.	Revisions	Date	By/Par

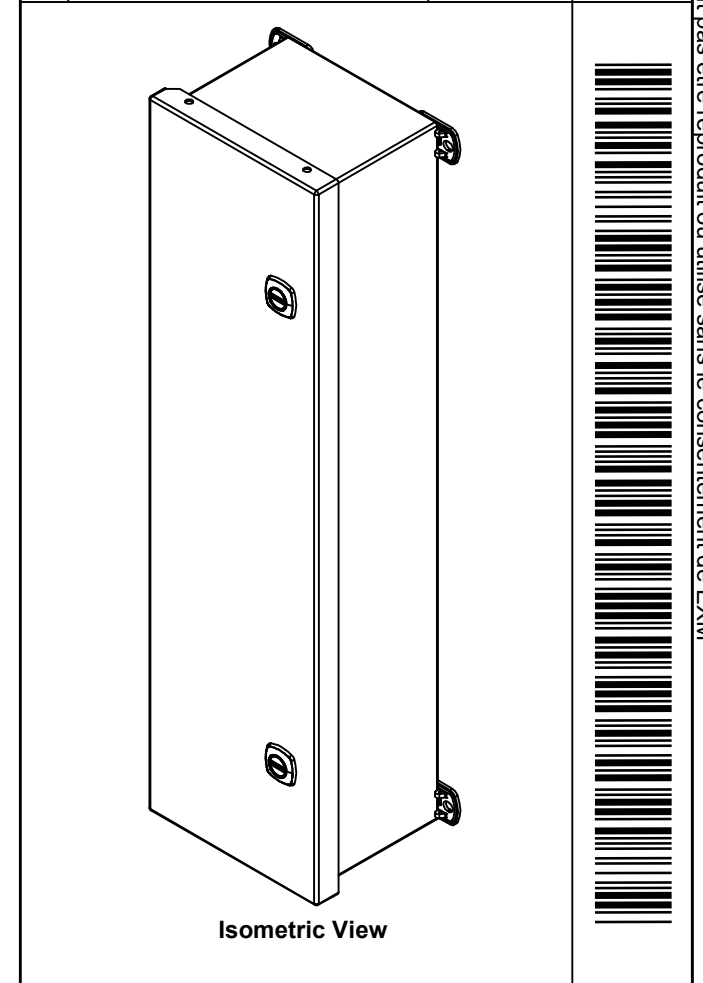

Tél: (450) 979-4373 Fax: (450) 979-4626 <a href="http://www.exmweb.com">www.exmweb.com</a>		Flatness Aplatissement
		Max 3.0mm
Customer Client		Date
Drawn By Dessiné Par BoxCad: BoxCad		Date 23-Nov-14
Material Matière 16 Ga Cold Rolled A1008 CS Type B (1.4mm)		
Color Couleur Asa-61 Grey	Finish Fini Smooth	
Description 1412CH 24" x 6" x 5" Assembly		Detail Rev.
Part Number Numéro Pièce	Rev. 0	1 / 11

SEE BILL OF MATERIAL ON LAST PAGE

**1412CH060524IP**

This drawing is confidential and must not be reproduced or used without the consent of EXM

Ce dessin est confidentiel et ne doit pas être reproduit ou utilisé sans le consentement de EXM

NOTE	
ITEM	DESCRIPTION
1	NEMA 4, 12 Enclosure (IP66)
2	C/W Standard ground standoffs on box and cover
3	W/O Standard door stiffener
4	C/W Special inner panel (Sold separately)
5	C/W Standard inner panel mounting standoffs

No.	Revisions	Date	By/Par

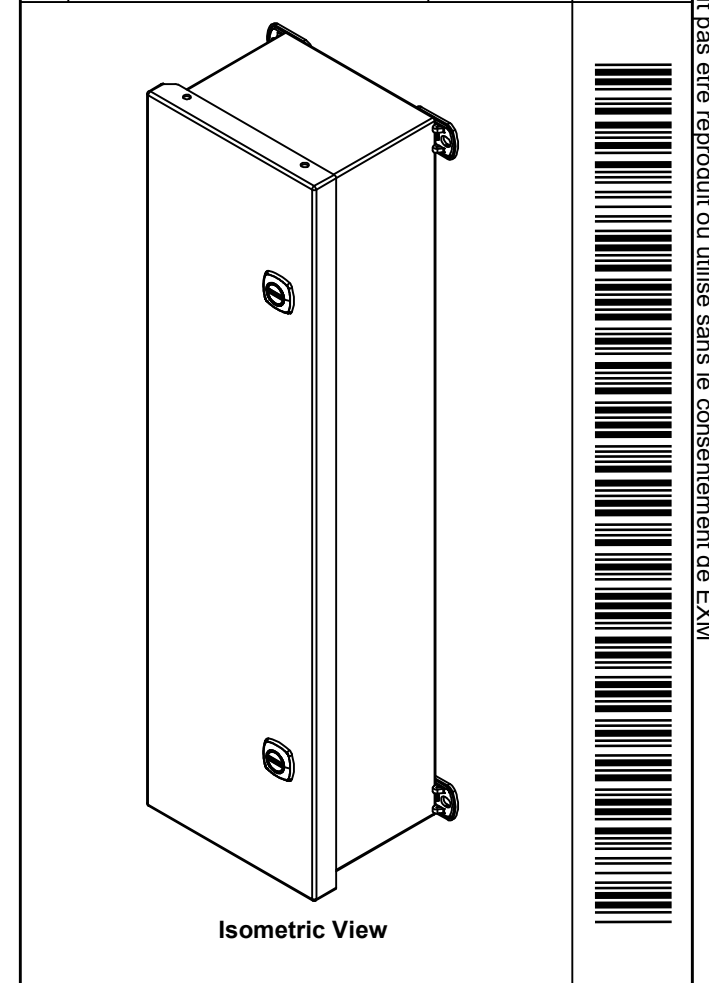



Tél: (450) 979-4373  
Fax: (450) 979-4626  
[www.exmweb.com](http://www.exmweb.com)

Flatness  
Aplatissement  
Max 3.0mm

Projection

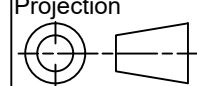

Customer Client	Date
Drawn By / Dessiné Par: BoxCad: BoxCad	Date: 23-Nov-14
Material / Matière: 16 Ga Cold Rolled A1008 CS Type B (1.4mm)	

2	STK-A-08126	0	M5 Stainless Steel 316 Nylon Insert Lock Nut with Incorporated Sealing Washer
1	1412CH060524IPC	0	1412CH 24" x 6" Cover
1	1412CH060524IPIP	0	1412CH 24" x 6" Inner Panel Part
1	1412CH060524IPB	0	1412CH 24" x 6" x 5" Body
2	STK-K-02570	0	1412 CH Accessory Kit
Qty	Part Number	Rev	Description
Parts List			

PACKING		
ITEM	QTY	DESCRIPTION
Cardboard sleeve	1	Top
Thermal plastic film	1	Use with Packing Tunnel Wrapper Machine
Packaging label	1	White label with product number

Color / Couleur: Asa-61 Grey	Finish / Fini: Smooth
Description: 1412CH 24" x 6" x 5" Assembly	Detail Rev.
Part Number / Numéro Pièce: <b>1412CH060524IP</b>	Rev. <b>0</b> / 2

This drawing is confidential and must not be reproduced or used without the consent of EXM

Ce dessin est confidentiel et ne doit pas être reproduit ou utilisé sans le consentement de EXM

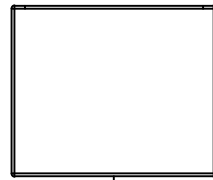

TOP

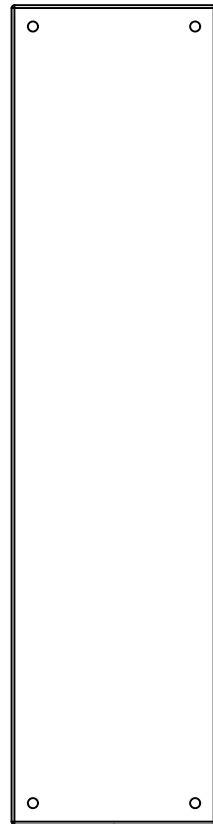

BACK



BOTTOM

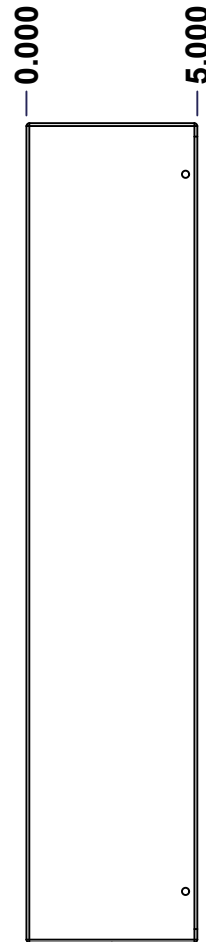

LEFT

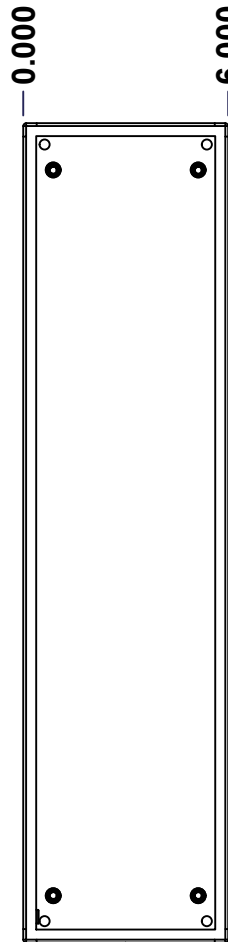

FRONT

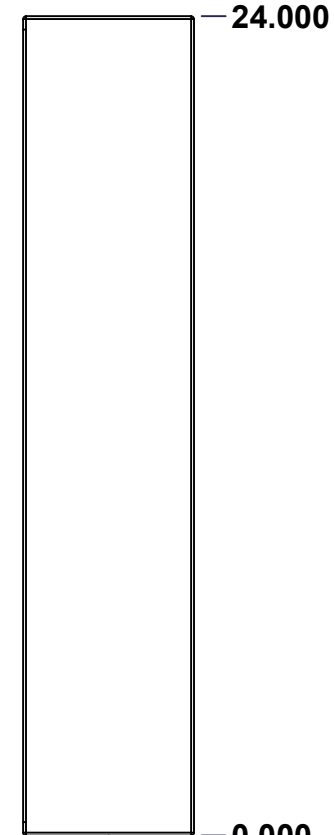

RIGHT

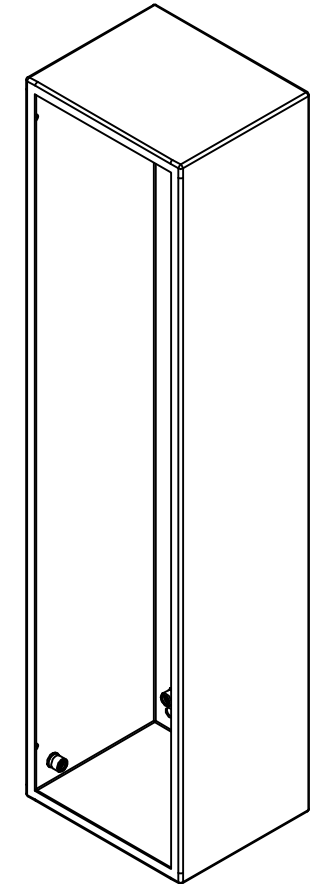

Isometric View

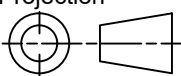

No.	Revisions	Date	By/Par

 Tél: (450) 979-4373 Fax: (450) 979-4626 <a href="http://www.exmweb.com">www.exmweb.com</a>		Flatness Aplatissement Max 3.0mm Projection 
Customer Client	Date	
Drawn By Dessiné Par	BoxCad: BoxCad	Date 23-Nov-14
Material Matière	16 Ga Cold Rolled A1008 CS Type B (1.4mm)	
Color Couleur	Asa-61 Grey	Finish Fini Smooth
Description	Detail Rev.	
1412CH 24" x 6" x 5" Body		
Part Number Numéro Pièce	Rev.	3
1412CH060524IPB	0	11

SEE BILL OF MATERIAL ON LAST PAGE

This drawing is confidential and must not be reproduced or used without the consent of EXM

Ce dessin est confidentiel et ne doit pas être reproduit ou utilisé sans le consentement de EXM

<b>STANDARD FEATURES ARE NOT LISTED IN THIS HOLE TABLE</b>			
<b>HOLE TABLE - LEFT VIEW (CUSTOM FEATURE ONLY)</b>			
CUT-OUT	XDIM	YDIM	DESCRIPTION
1	4.000	0.750	STANDOFF M6 x 10mm (Inside)

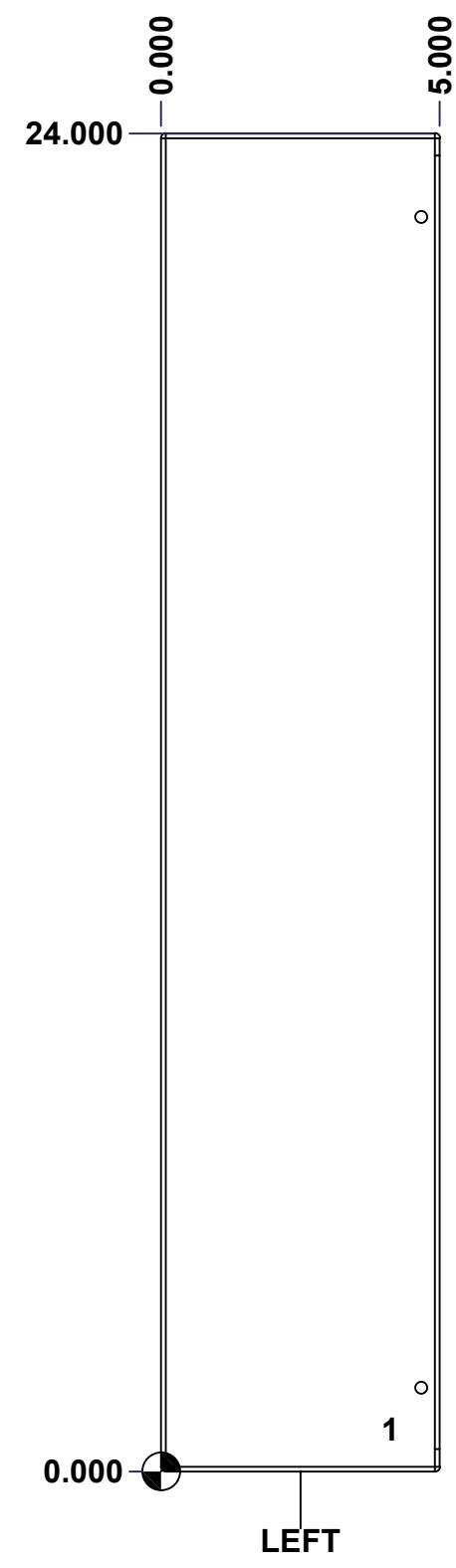

	Description 1412CH 24" x 6" x 5" Body	Status (NULL)
	Part Number Numéro Pièce <b>1412CH060524IPB</b>	Rev. 4 <b>0</b> / 11

This drawing is confidential and must not be reproduced or used without the consent of EXM

Ce dessin est confidentiel et ne doit pas être reproduit ou utilisé sans le consentement de EXM

**STANDARD FEATURES ARE NOT LISTED IN THIS HOLE TABLE**

**HOLE TABLE - BACK VIEW (CUSTOM FEATURE ONLY)**

CUT-OUT	XDIM	YDIM	DESCRIPTION
1	0.875	1.375	IP STANDOFF M6 x 10mm (Inside)
2	0.875	22.625	IP STANDOFF M6 x 10mm (Inside)
3	5.125	1.375	IP STANDOFF M6 x 10mm (Inside)
4	5.125	22.625	IP STANDOFF M6 x 10mm (Inside)

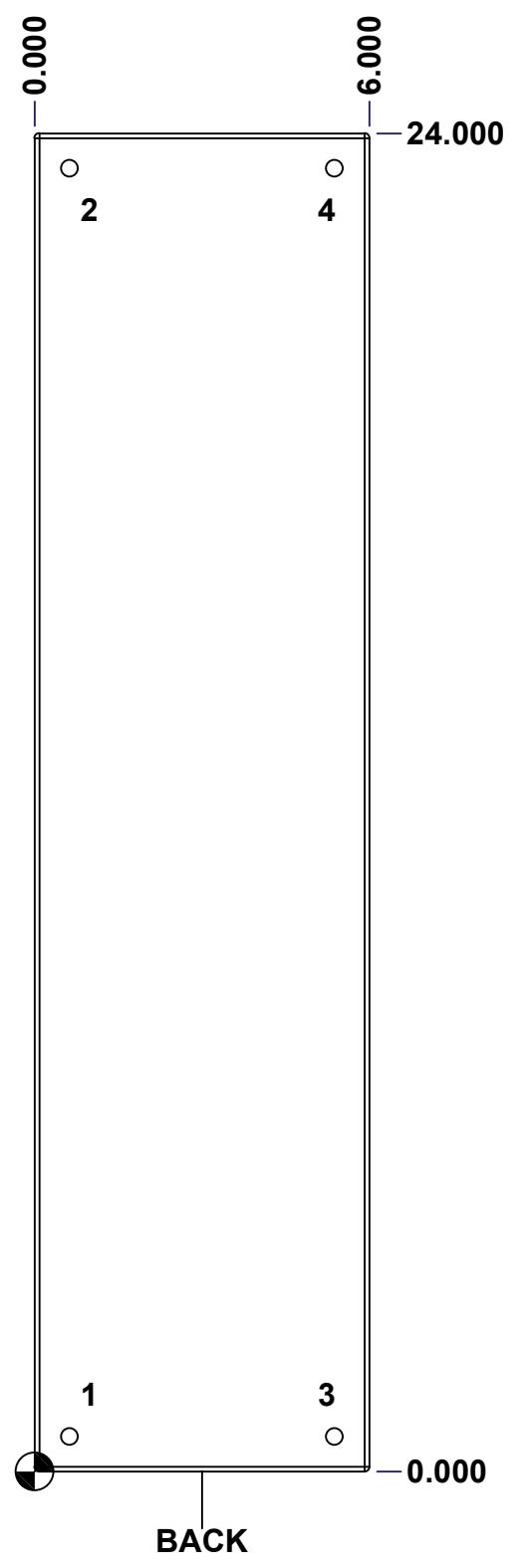



	Description 1412CH 24" x 6" x 5" Body	Status (NULL)
	Part Number Numéro Pièce <b>1412CH060524IPB</b>	Rev. 5 <b>0</b>

This drawing is confidential and must not be reproduced or used without the consent of EXM

Ce dessin est confidentiel et ne doit pas être reproduit ou utilisé sans le consentement de EXM

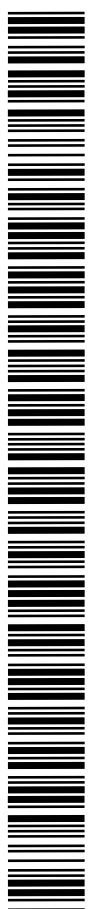
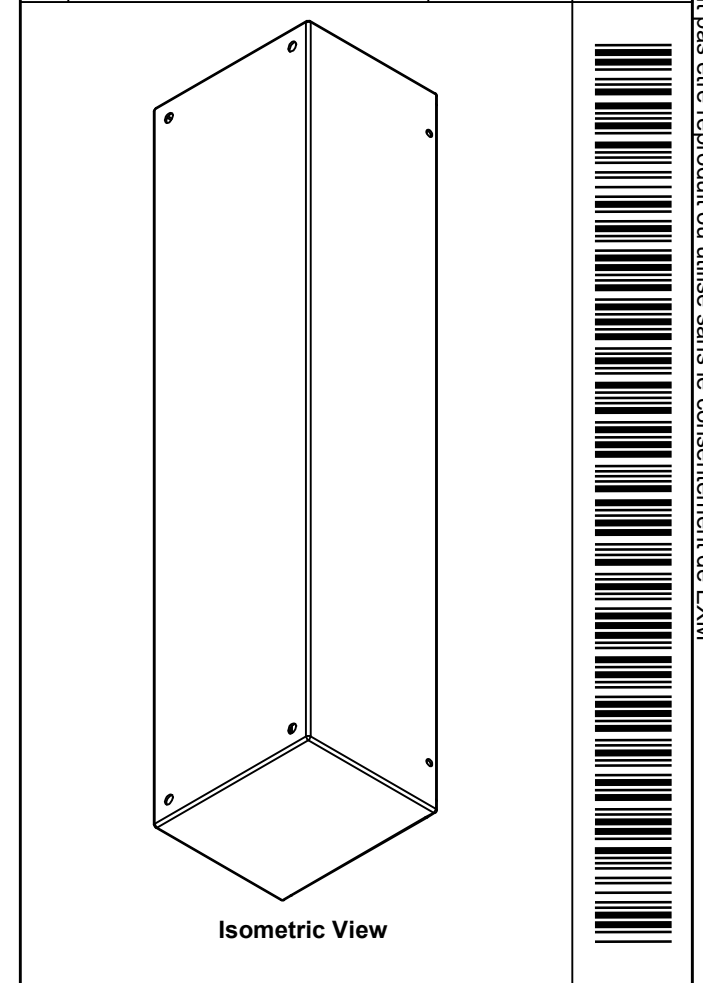
No.	Revisions	Date	By/Par

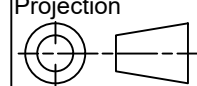

 Tél: (450) 979-4373 Fax: (450) 979-4626 <a href="http://www.exmweb.com">www.exmweb.com</a>		Flatness Aplatissement Max 3.0mm
Customer Client		Projection 
Drawn By Dessiné Par BoxCad: BoxCad		Date 23-Nov-14
Material Matière 16 Ga Cold Rolled A1008 CS Type B (1.4mm)		
Color Couleur Asa-61 Grey	Finish Fini Smooth	
Description 1412CH 24" x 6" x 5" Body		Detail Rev.
Part Number Numéro Pièce <b>1412CH060524IPB</b>		Rev. 6 <b>0</b>

Qty	Part Number	Rev	Description
1	STK-P-02400S	0	Powder Paint (Asa-61 Grey / Smooth)
1	1412CH060524IPB-P	0	1412CH 24" x 6" x 5" Body Part
5	STK-Q-08350	5	Standoff M6 x 10mm
Parts List			

This drawing is confidential and must not be reproduced or used without the consent of EXM

Ce dessin est confidentiel et ne doit pas être reproduit ou utilisé sans le consentement de EXM

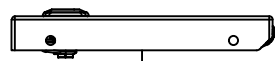

TOP

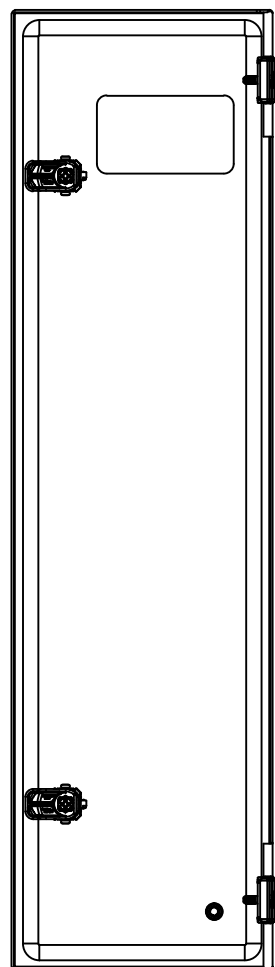

BACK

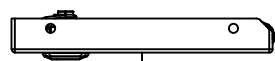

BOTTOM

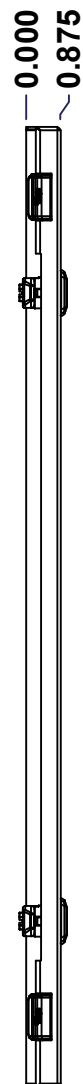

LEFT

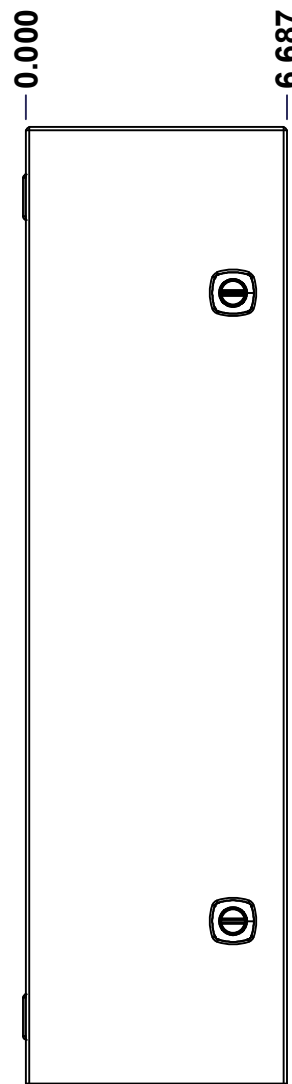

FRONT

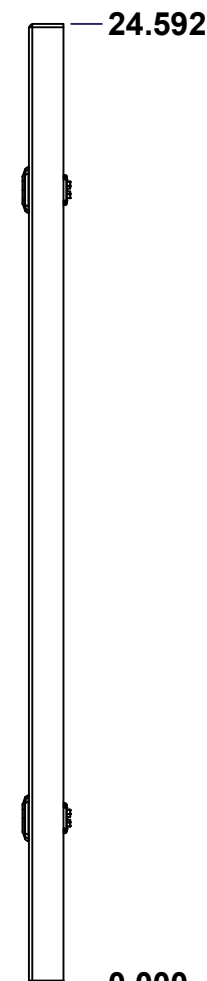

RIGHT

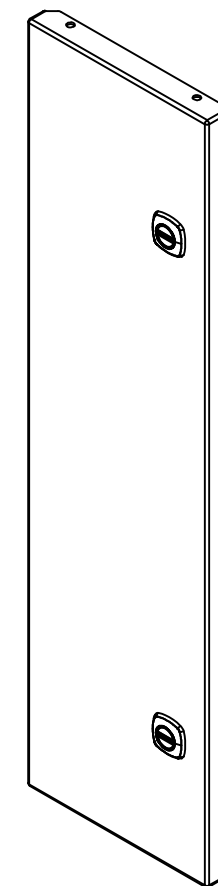

Isometric View

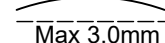
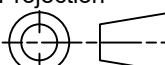

No.	Revisions	Date	By/Par

 Tél: (450) 979-4373 Fax: (450) 979-4626 <a href="http://www.exmweb.com">www.exmweb.com</a>		Flatness Aplatissement  Max 3.0mm Projection 
Customer Client	Date	
Drawn By Dessiné Par	BoxCad: BoxCad	Date 23-Nov-14
Material Matière	16 Ga Cold Rolled A1008 CS Type B (1.4mm)	
Color Couleur	Asa-61 Grey	Finish Fini Smooth
Description	Detail Rev.	
1412CH 24" x 6" Cover		
Part Number Numéro Pièce	Rev.	7
1412CH060524IPC	0	11

SEE BILL OF MATERIAL ON LAST PAGE

This drawing is confidential and must not be reproduced or used without the consent of EXM

Ce dessin est confidentiel et ne doit pas être reproduit ou utilisé sans le consentement de EXM

STANDARD FEATURES ARE NOT LISTED IN THIS HOLE TABLE			
HOLE TABLE - FRONT VIEW (CUSTOM FEATURE ONLY)			
CUT-OUT	XDIM	YDIM	DESCRIPTION
1	1.500	1.500	STANDOFF M6 x 10mm (Inside)
2	5.307	4.250	LOCK 880 SCQ4CH-SL @ 0.0°
3	5.307	20.342	LOCK 880 SCQ4CH-SL @ 0.0°

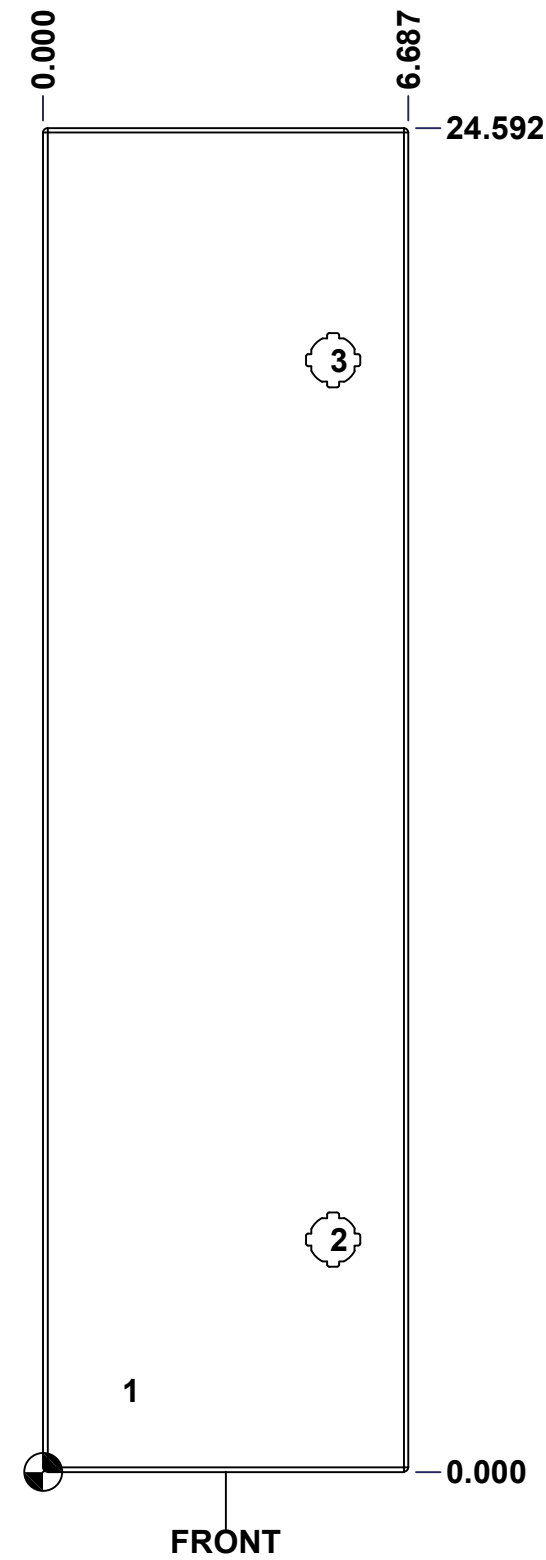

	Description 1412CH 24" x 6" Cover	Status (NULL)
	Part Number Numéro Pièce <b>1412CH060524IPC</b>	Rev. 8 <b>0</b>

This drawing is confidential and must not be reproduced or used without the consent of EXM

Ce dessin est confidentiel et ne doit pas être reproduit ou utilisé sans le consentement de EXM

No.	Revisions	Date	By/Par

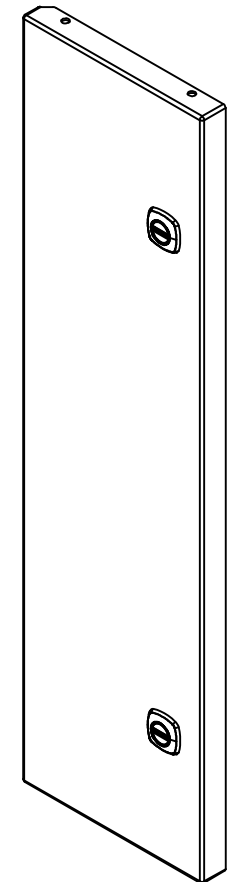

Isometric View

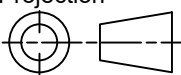

 Tél: (450) 979-4373 Fax: (450) 979-4626 <a href="http://www.exmweb.com">www.exmweb.com</a>	Flatness Aplatissement	Max 3.0mm
	Projection	
Customer Client	Date	
Drawn By Dessiné Par	BoxCad: BoxCad	Date 23-Nov-14
Material Matière	16 Ga Cold Rolled A1008 CS Type B (1.4mm)	
Color Couleur	Asa-61 Grey	Finish Fini Smooth
Description	Detail Rev.	
1412CH 24" x 6" Cover		
Part Number Numéro Pièce	Rev.	9
<b>1412CH060524IPC</b>	<b>0</b>	11

2	880 SCQ4CH-SL	0	5412 CH 1/4 Turn Lock
1	STK-Q-08350	5	Standoff M6 x 10mm
1	STK-P-02400S	0	Powder Paint (Asa-61 Grey / Smooth)
1	STK-S-00100	0	3.5" x 2" Silver Milar Flexcon Sticker
2	STK-A-33033	6	5412 ESCH Hinge Assembly
1	1412CH060524IPG	0	1412CH 24" x 6" Gasket
1	1412CH060524IPC-P	0	1412CH 24" x 6" Cover Part
QTY	Part Number	Rev	Description
Parts List			

This drawing is confidential and must not be reproduced or used without the consent of EXM

Ce dessin est confidentiel et ne doit pas être reproduit ou utilisé sans le consentement de EXM



TOP

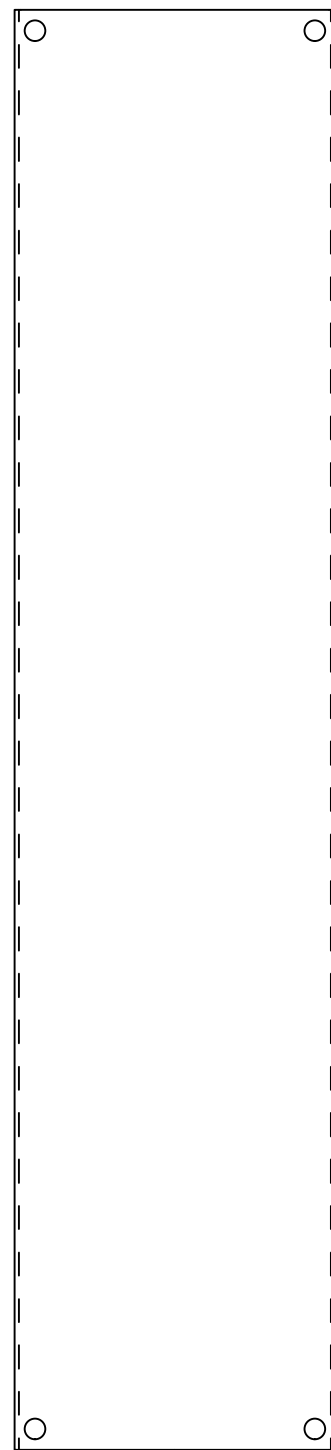

FRONT

21.880



0.000

RIGHT

SEE BILL OF MATERIAL ON LAST PAGE

No.	Revisions	Date	By/Par

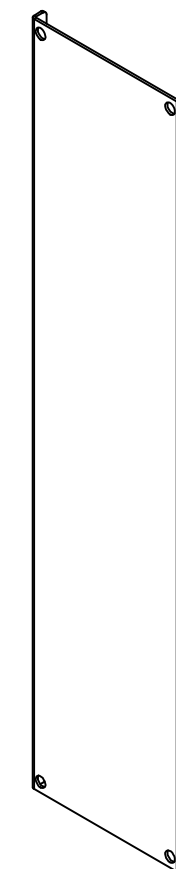

Isometric View



Tél: (450) 979-4373  
 Fax: (450) 979-4626  
[www.exmweb.com](http://www.exmweb.com)

Flatness  
Aplatissement

Max 3.0mm

Projection



Customer Client	Date
Drawn By / Dessiné Par: BoxCad: BoxCad	Date: 23-Nov-14
Material / Matière: 14 Ga Galvanized (1.7mm)	
Color / Couleur: Unpainted	Finish / Fini: Unpainted

Description: 1412CH 24" x 6" Inner Panel Part	Detail Rev.
---	-------------

Part Number / Numéro Pièce: 1412CH060524PIP	Rev. 0	10	11
---	--------	----	----

This drawing is confidential and must not be reproduced or used without the consent of EXM

Ce dessin est confidentiel et ne doit pas être reproduit ou utilisé sans le consentement de EXM

No.	Revisions	Date	By/Par

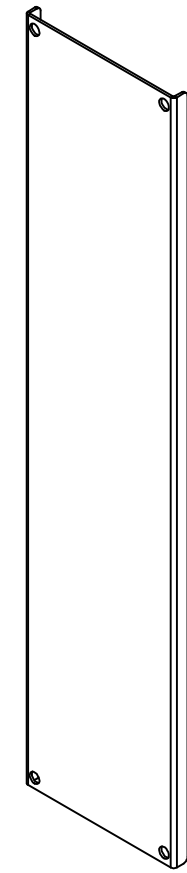

Isometric View

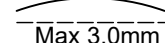

 Tél: (450) 979-4373 Fax: (450) 979-4626 <a href="http://www.exmweb.com">www.exmweb.com</a>		Flatness Aplatissement  Max 3.0mm
Customer Client		Date
Drawn By Dessiné Par BoxCad: BoxCad		Date 23-Nov-14
Material Matière 14 Ga Galvanized (1.7mm)		
Color Couleur Unpainted	Finish Fini Unpainted	
Description 1412CH 24" x 6" Inner Panel Part		Detail Rev.
Part Number Numéro Pièce <b>1412CH060524PIP</b>		Rev. 11 <b>0</b>

Qty	Part Number	Rev	Description
1	1412CH060524PIP-P	0	1412CH 24" x 6" Inner Panel Part
Parts List			