

This drawing is confidential and must not be reproduced or used without the consent of EXM

Ce dessin est confidentiel et ne doit pas être reproduit ou utilisé sans le consentement de EXM

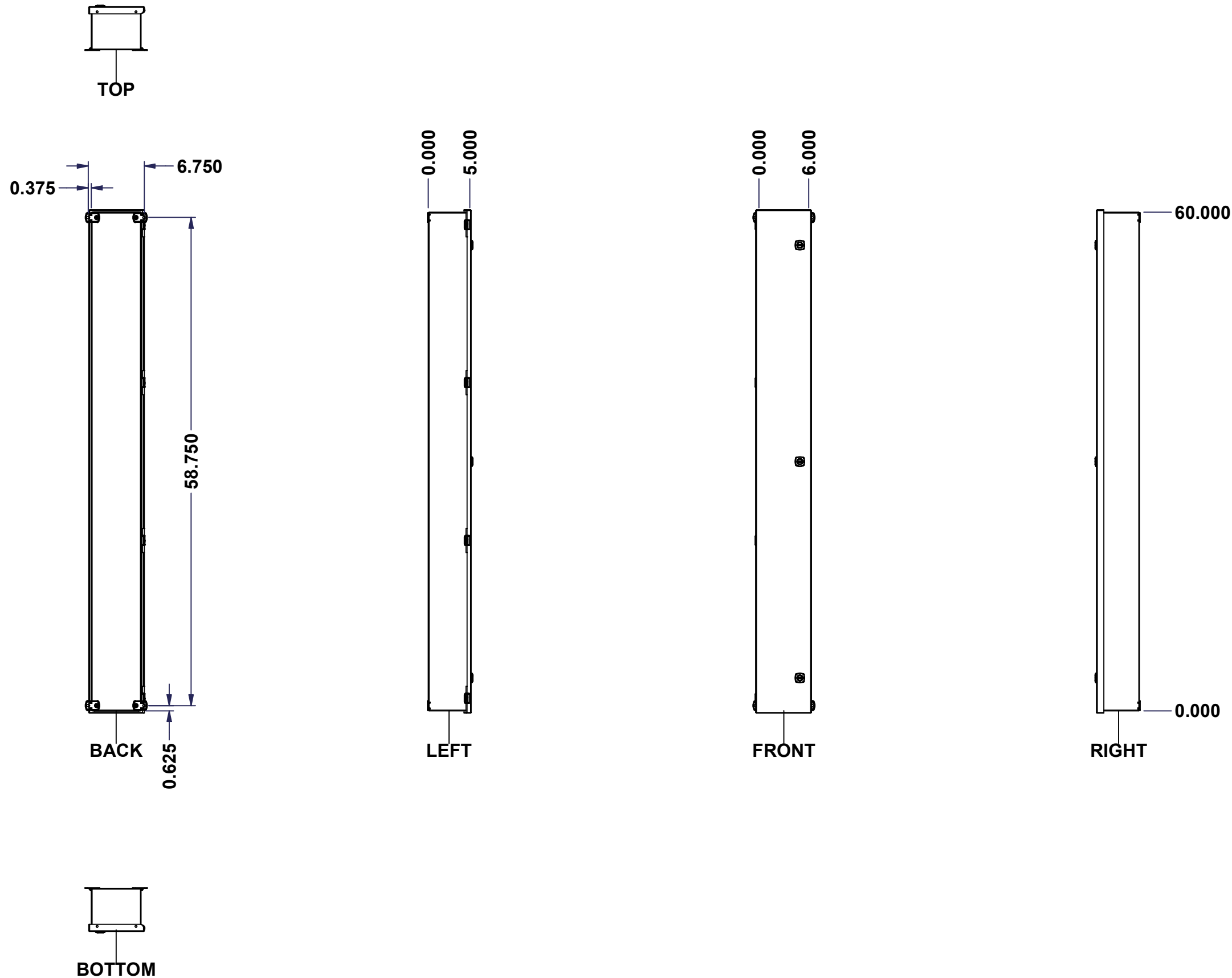

| No. | Revisions | Date | By/Par |
|-----|-----------|------|--------|
| | | | |
| | | | |
| | | | |
| | | | |
| | | | |

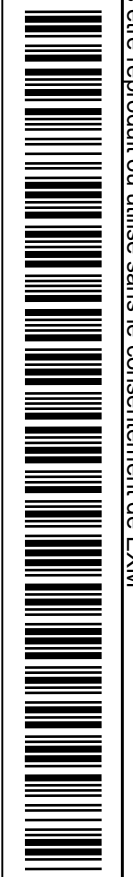
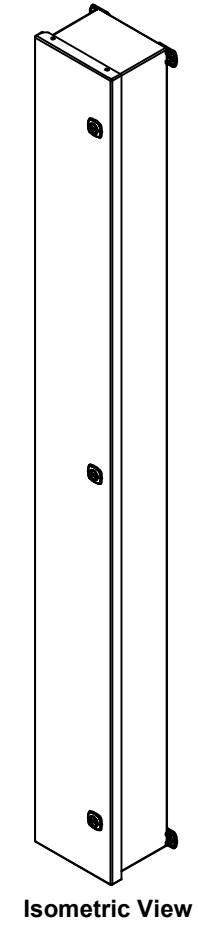

| | | |
|--|---|--|
| Tél: (450) 979-4373 Fax: (450) 979-4626 www.exmweb.com | | Flatness Aplatissement Max 3.0mm Projection |
| Customer Client | Date | |
| Drawn By Dessiné Par | BoxCad: BoxCad | Date 02-Mar-26 |
| Material Matière | 16 Ga Cold Rolled A1008 CS Type B (1.4mm) | |
| Color Couleur | Asa-61 Grey | Finish Fini Smooth |
| Description | Detail Rev. | |
| 1412CH 60" x 6" x 5" Assembly | | |
| Part Number Numéro Pièce | Rev. | 1 |
| 1412CH060560IP | 0 | 11 |

SEE BILL OF MATERIAL ON LAST PAGE

This drawing is confidential and must not be reproduced or used without the consent of EXM

Ce dessin est confidentiel et ne doit pas être reproduit ou utilisé sans le consentement de EXM

| NOTE | |
|------|--|
| ITEM | DESCRIPTION |
| 1 | NEMA 4, 12 Enclosure (IP66) |
| 2 | C/W Standard ground standoffs on box and cover |
| 3 | W/O Standard door stiffener |
| 4 | C/W Special inner panel (Sold separately) |
| 5 | C/W Standard inner panel mounting standoffs |

| No. | Revisions | Date | By/Par |
|-----|-----------|------|--------|
| | | | |
| | | | |
| | | | |
| | | | |
| | | | |
| | | | |

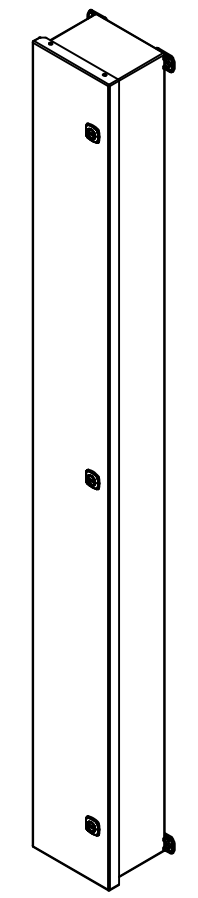

Isometric View

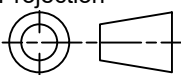

| | |
|--|---|
|  Tél: (450) 979-4373 Fax: (450) 979-4626 www.exmweb.com | Flatness Aplatissement |
| | Max 3.0mm |
| Projection |  |
| Customer Client | Date |
| Drawn By Dessiné Par BoxCad: BoxCad | Date 02-Mar-26 |
| Material Matière 16 Ga Cold Rolled A1008 CS Type B (1.4mm) | |

| | | | |
|------------|------------------|-----|---|
| 4 | STK-A-08126 | 0 | M5 Stainless Steel 316 Nylon Insert Lock Nut with Incorporated Sealing Washer |
| 1 | 1412CH060560IPC | 0 | 1412CH 60" x 6" Cover |
| 1 | 1412CH060560IPIP | 0 | 1412CH 60" x 6" Inner Panel Part |
| 1 | 1412CH060560IPB | 0 | 1412CH 60" x 6" x 5" Body |
| 2 | STK-K-02570 | 0 | 1412 CH Accessory Kit |
| Qty | Part Number | Rev | Description |
| Parts List | | | |

| PACKING | | |
|----------------------|-----|---|
| ITEM | QTY | DESCRIPTION |
| Cardboard sleeve | 1 | Top |
| Thermal plastic film | 1 | Use with Packing Tunnel Wrapper Machine |
| Packaging label | 1 | White label with product number |

| | |
|--|-----------------------|
| Color Couleur Asa-61 Grey | Finish Fini Smooth |
| Description 1412CH 60" x 6" x 5" Assembly | Detail Rev. |
| Part Number Numéro Pièce 1412CH060560IP | Rev. 0 |
| | 2 11 |

This drawing is confidential and must not be reproduced or used without the consent of EXM

Ce dessin est confidentiel et ne doit pas être reproduit ou utilisé sans le consentement de EXM



TOP

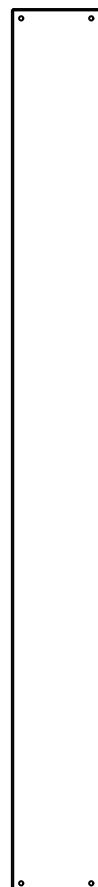

BACK



BOTTOM

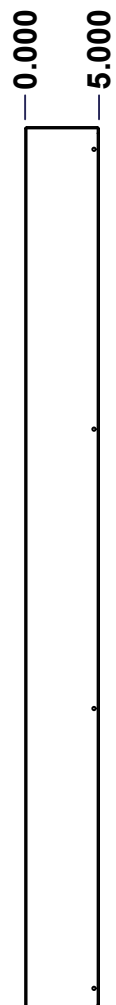

LEFT

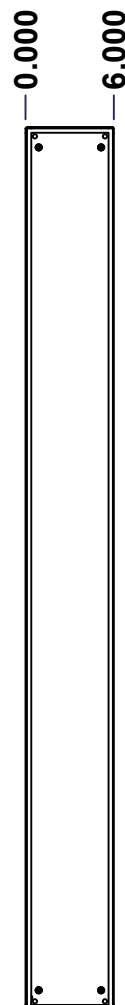

FRONT

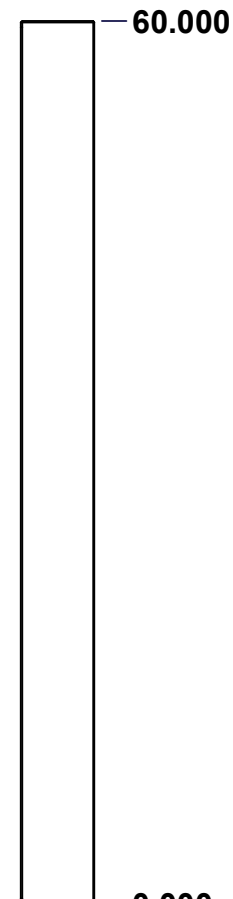

RIGHT

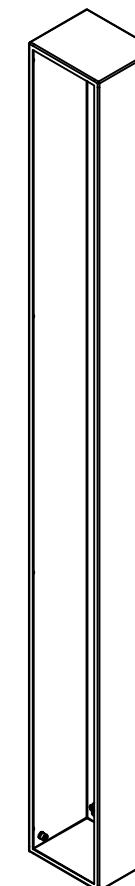

Isometric View

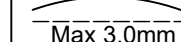
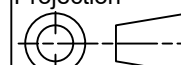

| No. | Revisions | Date | By/Par |
|-----|-----------|------|--------|
| | | | |
| | | | |
| | | | |
| | | | |
| | | | |

| | | |
|--|---|--|
|  Tél: (450) 979-4373 Fax: (450) 979-4626 www.exmweb.com | | Flatness Aplatissement  Max 3.0mm Projection  |
| Customer Client | Date | |
| Drawn By Dessiné Par | BoxCad: BoxCad | Date 02-Mar-26 |
| Material Matière | 16 Ga Cold Rolled A1008 CS Type B (1.4mm) | |
| Color Couleur | Asa-61 Grey | Finish Fini Smooth |
| Description | Detail Rev. | |
| 1412CH 60" x 6" x 5" Body | | |
| Part Number Numéro Pièce | Rev. | 3 |
| 1412CH060560IPB | 0 | 11 |

SEE BILL OF MATERIAL ON LAST PAGE

This drawing is confidential and must not be reproduced or used without the consent of EXM

Ce dessin est confidentiel et ne doit pas être reproduit ou utilisé sans le consentement de EXM

| STANDARD FEATURES ARE NOT LISTED IN THIS HOLE TABLE | | | |
|--|-------|-------|-----------------------------|
| HOLE TABLE - LEFT VIEW (CUSTOM FEATURE ONLY) | | | |
| CUT-OUT | XDIM | YDIM | DESCRIPTION |
| 1 | 4.000 | 0.750 | STANDOFF M6 x 10mm (Inside) |

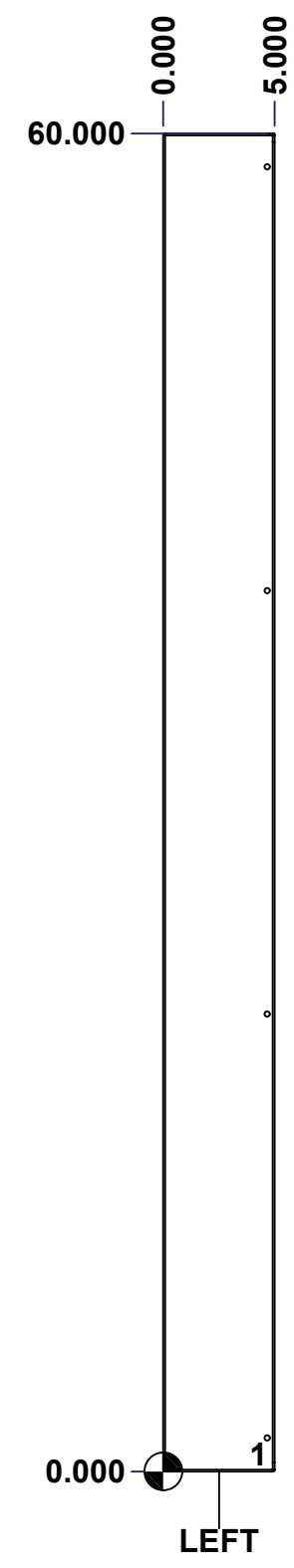

| | | | |
|--|-----------------------------|----------|---------|
| | Description | Status | |
| | 1412CH 60" x 6" x 5" Body | (NULL) | |
| | Part Number Numéro Pièce | Rev. | |
| | 1412CH060560IPB | 0 | 4 11 |

This drawing is confidential and must not be reproduced or used without the consent of EXM

Ce dessin est confidentiel et ne doit pas être reproduit ou utilisé sans le consentement de EXM

| STANDARD FEATURES ARE NOT LISTED IN THIS HOLE TABLE | | | |
|---|-------|--------|--------------------------------|
| HOLE TABLE - BACK VIEW (CUSTOM FEATURE ONLY) | | | |
| CUT-OUT | XDIM | YDIM | DESCRIPTION |
| 1 | 0.875 | 1.375 | IP STANDOFF M6 x 10mm (Inside) |
| 2 | 0.875 | 58.625 | IP STANDOFF M6 x 10mm (Inside) |
| 3 | 5.125 | 1.375 | IP STANDOFF M6 x 10mm (Inside) |
| 4 | 5.125 | 58.625 | IP STANDOFF M6 x 10mm (Inside) |

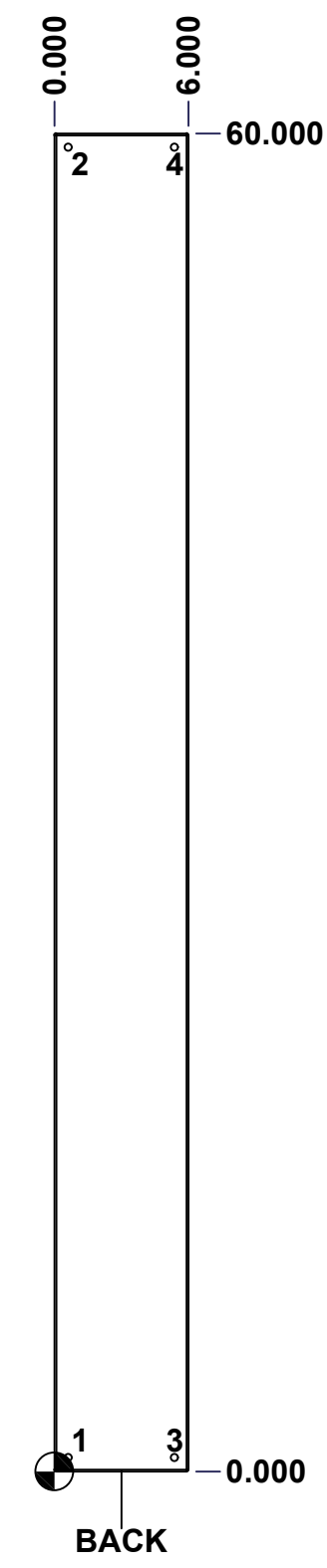

| | | |
|--|-----------------------------|--------------|
| | Description | Status |
| | 1412CH 60" x 6" x 5" Body | (NULL) |
| | Part Number Numéro Pièce | Rev. |
| | 1412CH060560IPB | 0 / 5 |
| | | 11 |

This drawing is confidential and must not be reproduced or used without the consent of EXM

Ce dessin est confidentiel et ne doit pas être reproduit ou utilisé sans le consentement de EXM

| No. | Revisions | Date | By/Par |
|-----|-----------|------|--------|
| | | | |
| | | | |
| | | | |
| | | | |
| | | | |

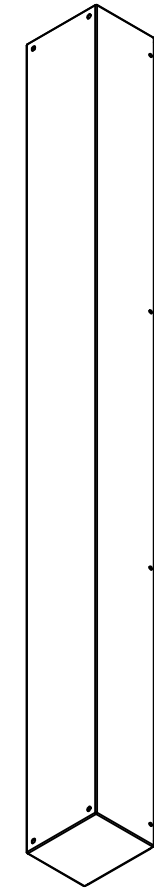

Isometric View

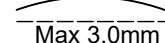

| | | |
|--|-----------------------|---|
|  Tél: (450) 979-4373 Fax: (450) 979-4626 www.exmweb.com | | Flatness Aplatissement  Max 3.0mm |
| Customer Client | | Date |
| Drawn By / Dessiné Par: BoxCad: BoxCad | | Date: 02-Mar-26 |
| Material / Matière: 16 Ga Cold Rolled A1008 CS Type B (1.4mm) | | |
| Color / Couleur: Asa-61 Grey | Finish / Fini: Smooth | |
| Description: 1412CH 60" x 6" x 5" Body | | Detail Rev. |
| Part Number / Numéro Pièce: 1412CH060560IPB | | Rev. 6 0 |

| Qty | Part Number | Rev | Description |
|------------|-------------------|-----|-------------------------------------|
| 1 | STK-P-02400S | 0 | Powder Paint (Asa-61 Grey / Smooth) |
| 1 | 1412CH060560IPB-P | 0 | 1412CH 60" x 6" x 5" Body Part |
| 5 | STK-Q-08350 | 5 | Standoff M6 x 10mm |
| Parts List | | | |

This drawing is confidential and must not be reproduced or used without the consent of EXM

Ce dessin est confidentiel et ne doit pas être reproduit ou utilisé sans le consentement de EXM

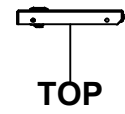

TOP

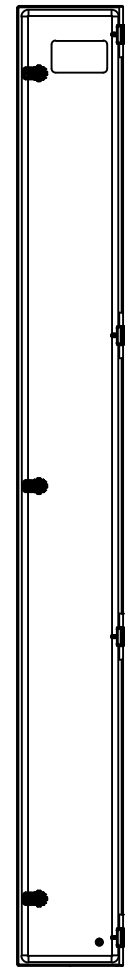

BACK

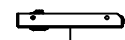

BOTTOM

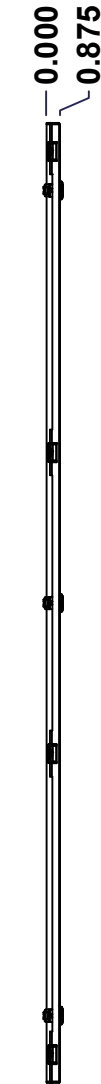

LEFT

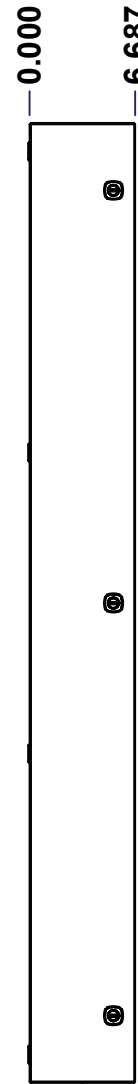

FRONT

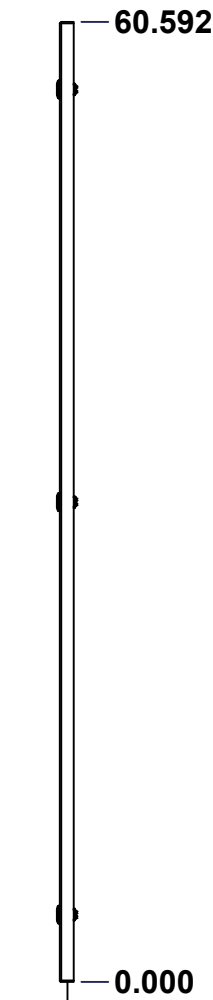

RIGHT

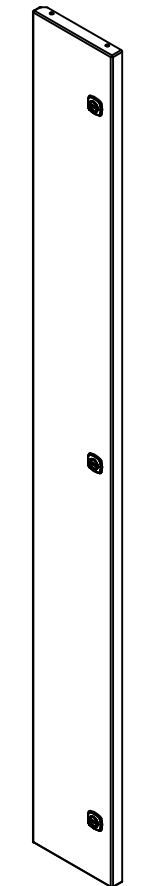

Isometric View

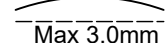
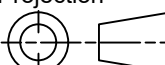

| No. | Revisions | Date | By/Par |
|-----|-----------|------|--------|
| | | | |
| | | | |
| | | | |
| | | | |
| | | | |

| | | |
|--|---|--|
|  Tél: (450) 979-4373 Fax: (450) 979-4626 www.exmweb.com | | Flatness Aplatissement  Max 3.0mm Projection  |
| Customer Client | Date | |
| Drawn By Dessiné Par | BoxCad: BoxCad | Date 02-Mar-26 |
| Material Matière | 16 Ga Cold Rolled A1008 CS Type B (1.4mm) | |
| Color Couleur | Asa-61 Grey | Finish Fini Smooth |
| Description | Detail Rev. | |
| 1412CH 60" x 6" Cover | | |
| Part Number Numéro Pièce | Rev. | 7 |
| 1412CH060560IPC | 0 | 11 |

SEE BILL OF MATERIAL ON LAST PAGE

This drawing is confidential and must not be reproduced or used without the consent of EXM

Ce dessin est confidentiel et ne doit pas être reproduit ou utilisé sans le consentement de EXM

| STANDARD FEATURES ARE NOT LISTED IN THIS HOLE TABLE | | | |
|---|-------|--------|-----------------------------|
| HOLE TABLE - FRONT VIEW (CUSTOM FEATURE ONLY) | | | |
| CUT-OUT | XDIM | YDIM | DESCRIPTION |
| 1 | 1.500 | 1.500 | STANDOFF M6 x 10mm (Inside) |
| 2 | 5.307 | 4.250 | LOCK 880 SCQ4CH-SL @ 0.0° |
| 3 | 5.307 | 30.296 | LOCK 880 SCQ4CH-SL @ 0.0° |
| 4 | 5.307 | 56.342 | LOCK 880 SCQ4CH-SL @ 0.0° |

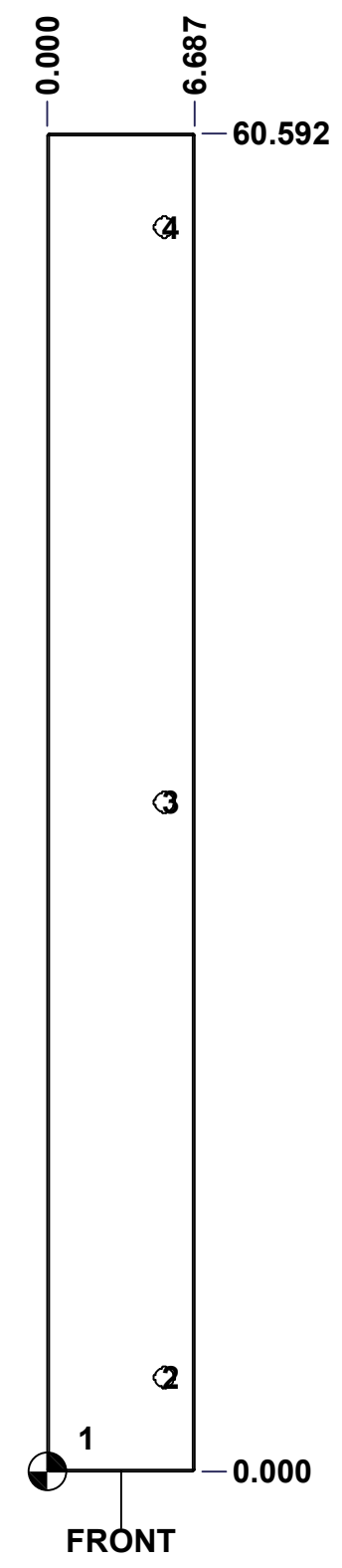

| | | |
|--|---|--------------------|
| | Description 1412CH 60" x 6" Cover | Status (NULL) |
| | Part Number Numéro Pièce 1412CH060560IPC | Rev. 8 0 |

This drawing is confidential and must not be reproduced or used without the consent of EXM

Ce dessin est confidentiel et ne doit pas être reproduit ou utilisé sans le consentement de EXM

| No. | Revisions | Date | By/Par |
|-----|-----------|------|--------|
| | | | |
| | | | |
| | | | |
| | | | |
| | | | |

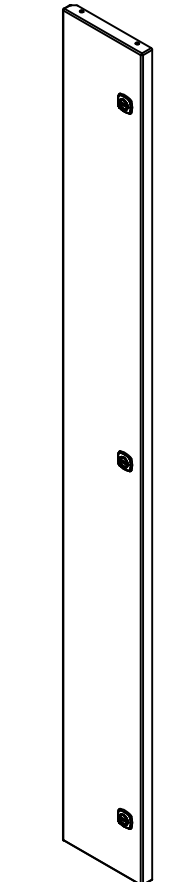

Isometric View

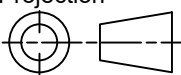

| | | |
|--|---|---|
|  Tél: (450) 979-4373 Fax: (450) 979-4626 www.exmweb.com | Flatness Aplatissement | Max 3.0mm |
| | Projection |  |
| Customer Client | Date | |
| Drawn By Dessiné Par | BoxCad: BoxCad | Date 02-Mar-26 |
| Material Matière | 16 Ga Cold Rolled A1008 CS Type B (1.4mm) | |
| Color Couleur | Asa-61 Grey | Finish Fini Smooth |
| Description | Detail Rev. | |
| 1412CH 60" x 6" Cover | | |
| Part Number Numéro Pièce | Rev. | 9 |
| 1412CH060560IPC | | 0 |

| QTY | Part Number | Rev | Description |
|------------|-------------------|-----|--|
| 3 | 880 SCQ4CH-SL | 0 | 5412 CH 1/4 Turn Lock |
| 1 | STK-Q-08350 | 5 | Standoff M6 x 10mm |
| 1 | STK-P-02400S | 0 | Powder Paint (Asa-61 Grey / Smooth) |
| 1 | STK-S-00100 | 0 | 3.5" x 2" Silver Milar Flexcon Sticker |
| 4 | STK-A-33033 | 6 | 5412 ESCH Hinge Assembly |
| 1 | 1412CH060560IPG | 0 | 1412CH 60" x 6" Gasket |
| 1 | 1412CH060560IPC-P | 0 | 1412CH 60" x 6" Cover Part |
| Parts List | | | |

This drawing is confidential and must not be reproduced or used without the consent of EXM

Ce dessin est confidentiel et ne doit pas être reproduit ou utilisé sans le consentement de EXM

0.000
TOP
4.880

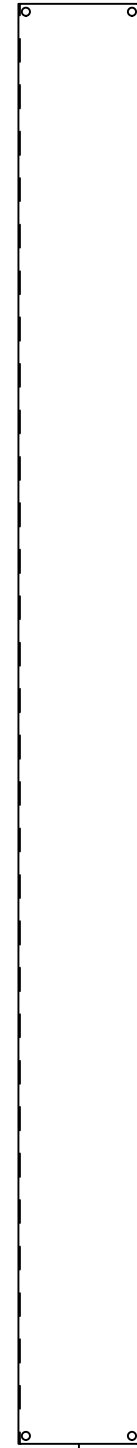

FRONT

57.880



RIGHT

0.000

SEE BILL OF MATERIAL ON LAST PAGE

| No. | Revisions | Date | By/Par |
|-----|-----------|------|--------|
| | | | |
| | | | |
| | | | |
| | | | |
| | | | |

Isometric View

| | | | |
|--|--|---------------------------|-------------|
| Tél: (450) 979-4373 Fax: (450) 979-4626 www.exmweb.com | | Flatness Aplatissement | |
| | | Max 3.0mm | |
| Customer Client | | Date | |
| Drawn By Dessiné Par BoxCad: BoxCad | | Date 02-Mar-26 | |
| Material Matière 14 Ga Galvanized (1.7mm) | | | |
| Color Couleur Unpainted | | Finish Fini Unpainted | |
| Description 1412CH 60" x 6" Inner Panel Part | | | Detail Rev. |
| Part Number Numéro Pièce 1412CH060560IPI | | Rev. 0 | 10 11 |

This drawing is confidential and must not be reproduced or used without the consent of EXM

Ce dessin est confidentiel et ne doit pas être reproduit ou utilisé sans le consentement de EXM

| No. | Revisions | Date | By/Par |
|-----|-----------|------|--------|
| | | | |
| | | | |
| | | | |
| | | | |
| | | | |

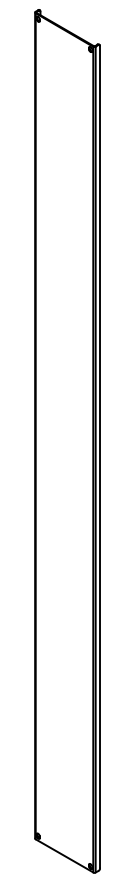

Isometric View

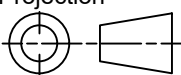

| | |
|--|---|
|  Tél: (450) 979-4373 Fax: (450) 979-4626 www.exmweb.com | Flatness Aplatissement |
| | Max 3.0mm |
| Projection |  |
| Customer Client | Date |
| Drawn By Dessiné Par BoxCad: BoxCad | Date 02-Mar-26 |
| Material Matière | 14 Ga Galvanized (1.7mm) |
| Color Couleur Unpainted | Finish Fini Unpainted |
| Description | Detail Rev. |
| 1412CH 60" x 6" Inner Panel Part | |
| Part Number Numéro Pièce | Rev. 11 |
| 1412CH060560IPIP | 0 11 |

| Qty | Part Number | Rev | Description |
|------------|--------------------|-----|----------------------------------|
| 1 | 1412CH060560IPIP-P | 0 | 1412CH 60" x 6" Inner Panel Part |
| Parts List | | | |