

This drawing is confidential and must not be reproduced or used without the consent of EXM

Ce dessin est confidentiel et ne doit pas être reproduit ou utilisé sans le consentement de EXM

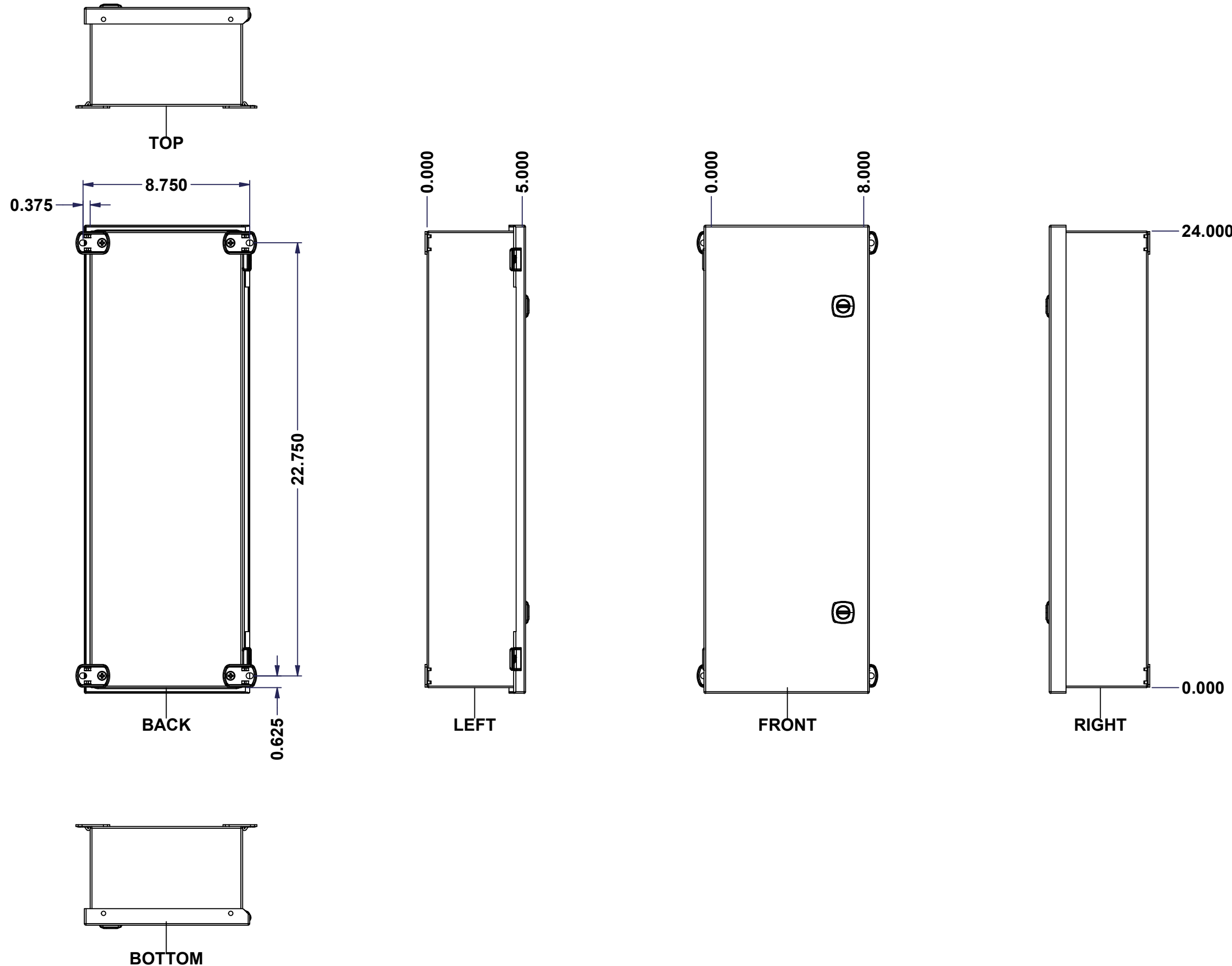

No.	Revisions	Date	By/Par

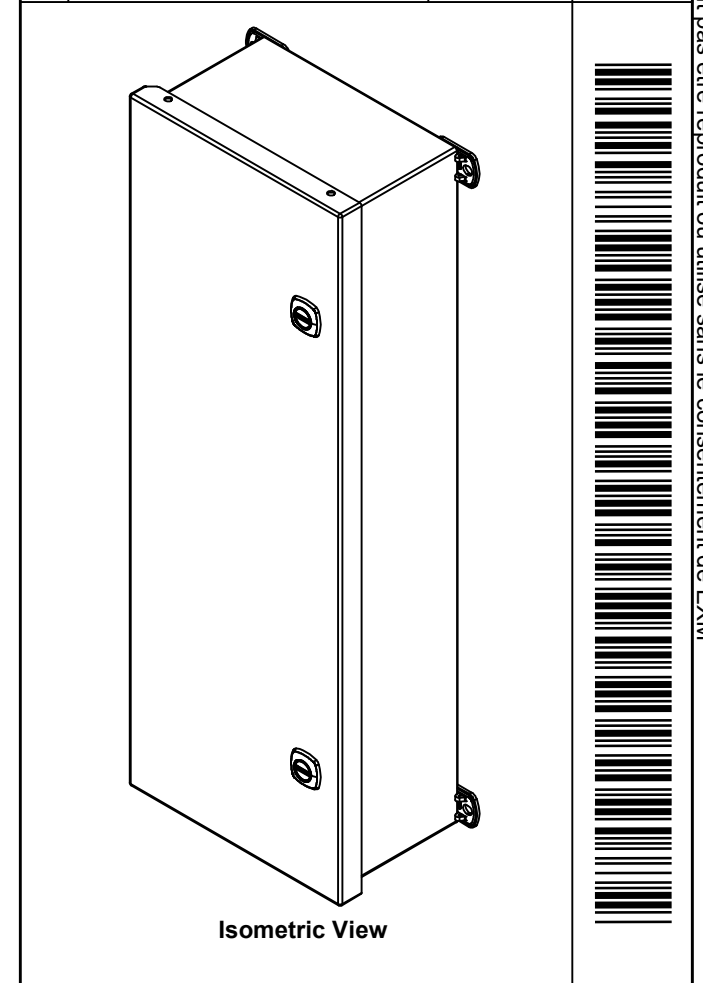

Tél: (450) 979-4373 Fax: (450) 979-4626 www.exmweb.com		Flatness Aplatissement Max 3.0mm Projection
Customer Client	Date	
Drawn By Dessiné Par	BoxCad: BoxCad	Date 02-Sep-25
Material Matière	16 Ga Cold Rolled A1008 CS Type B (1.4mm)	
Color Couleur	Asa-61 Grey	Finish Fini Smooth
Description	Detail Rev.	
1412CH 24" x 8" x 5" Assembly		
Part Number Numéro Pièce	Rev. 0	1 / 11

SEE BILL OF MATERIAL ON LAST PAGE

1412CH080524IP

This drawing is confidential and must not be reproduced or used without the consent of EXM

Ce dessin est confidentiel et ne doit pas être reproduit ou utilisé sans le consentement de EXM

NOTE	
ITEM	DESCRIPTION
1	NEMA 4, 12 Enclosure (IP66)
2	C/W Standard ground standoffs on box and cover
3	W/O Standard door stiffener
4	C/W Special inner panel (Sold separately)
5	C/W Standard inner panel mounting standoffs

No.	Revisions	Date	By/Par

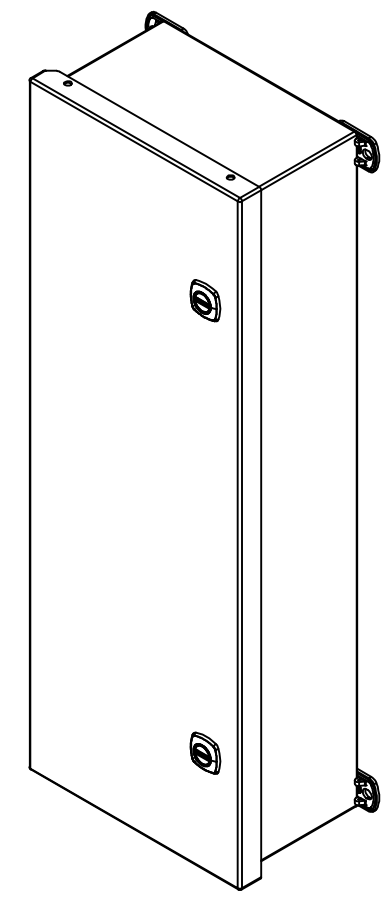

Isometric View

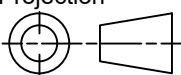

 Tél: (450) 979-4373 Fax: (450) 979-4626 www.exmweb.com	Flatness Aplatissement
	Max 3.0mm
Projection	
Customer Client	Date
Drawn By Dessiné Par BoxCad: BoxCad	Date 02-Sep-25
Material Matière 16 Ga Cold Rolled A1008 CS Type B (1.4mm)	

Qty	Part Number	Rev	Description
2	STK-A-08126	0	M5 Stainless Steel 316 Nylon Insert Lock Nut with Incorporated Sealing Washer
1	1412CH080524IPC	0	1412CH 24" x 8" Cover
1	1412CH080524IPIP	0	1412CH 24" x 8" Inner Panel Part
1	1412CH080524IPB	0	1412CH 24" x 8" x 5" Body
2	STK-K-02570	0	1412 CH Accessory Kit
Parts List			

PACKING		
ITEM	QTY	DESCRIPTION
Cardboard sleeve	1	Top
Thermal plastic film	1	Use with Packing Tunnel Wrapper Machine
Packaging label	1	White label with product number

Color Couleur Asa-61 Grey	Finish Fini Smooth
Description 1412CH 24" x 8" x 5" Assembly	Detail Rev.
Part Number Numéro Pièce 1412CH080524IP	Rev. 0 / 2

This drawing is confidential and must not be reproduced or used without the consent of EXM

Ce dessin est confidentiel et ne doit pas être reproduit ou utilisé sans le consentement de EXM

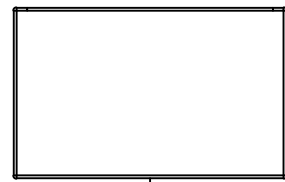

TOP

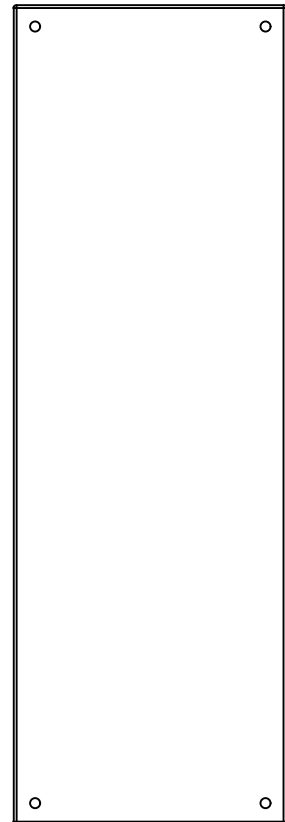

BACK

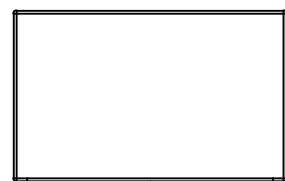

BOTTOM

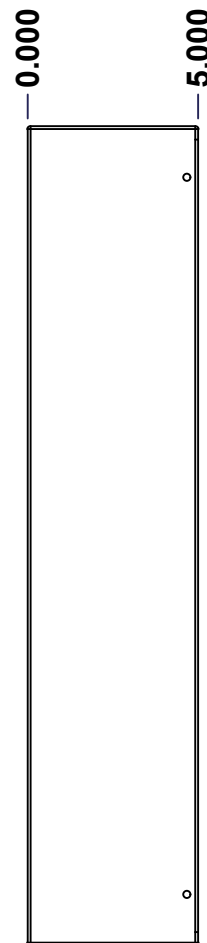

LEFT

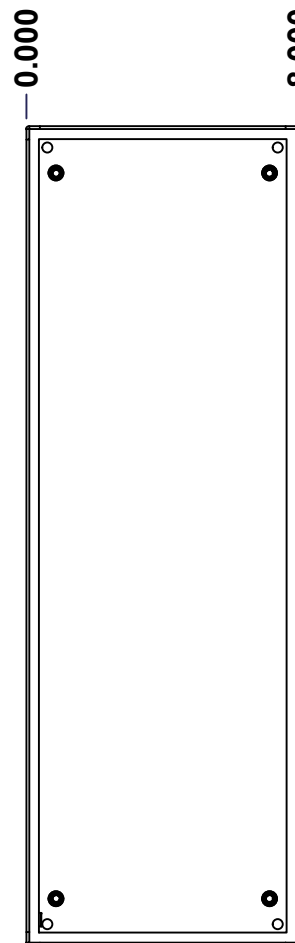

FRONT

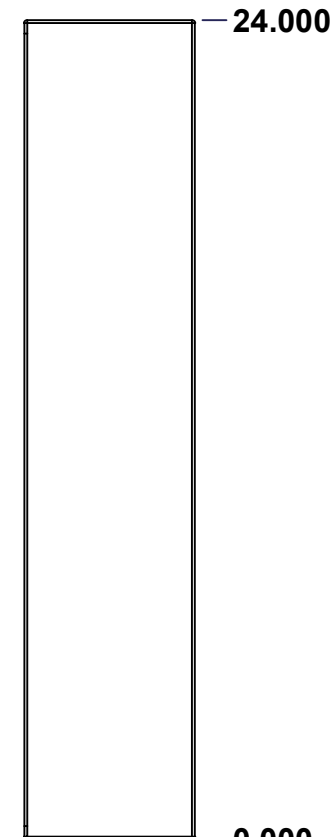

RIGHT

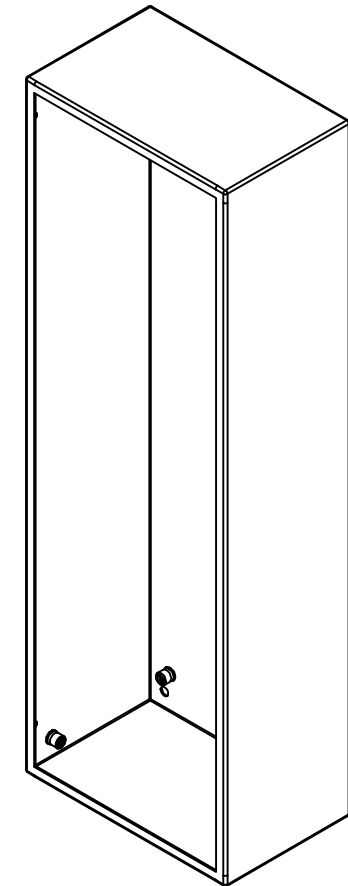

Isometric View

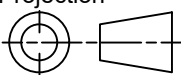

No.	Revisions	Date	By/Par

 Tél: (450) 979-4373 Fax: (450) 979-4626 www.exmweb.com		Flatness Aplatissement Max 3.0mm Projection 
Customer Client	Date	
Drawn By Dessiné Par	BoxCad: BoxCad	Date 02-Sep-25
Material Matière	16 Ga Cold Rolled A1008 CS Type B (1.4mm)	
Color Couleur	Asa-61 Grey	Finish Fini Smooth
Description	Detail Rev.	
1412CH 24" x 8" x 5" Body		
Part Number Numéro Pièce	Rev.	3
1412CH080524IPB	0	11

SEE BILL OF MATERIAL ON LAST PAGE

This drawing is confidential and must not be reproduced or used without the consent of EXM

Ce dessin est confidentiel et ne doit pas être reproduit ou utilisé sans le consentement de EXM

STANDARD FEATURES ARE NOT LISTED IN THIS HOLE TABLE			
HOLE TABLE - LEFT VIEW (CUSTOM FEATURE ONLY)			
CUT-OUT	XDIM	YDIM	DESCRIPTION
1	4.000	0.750	STANDOFF M6 x 10mm (Inside)

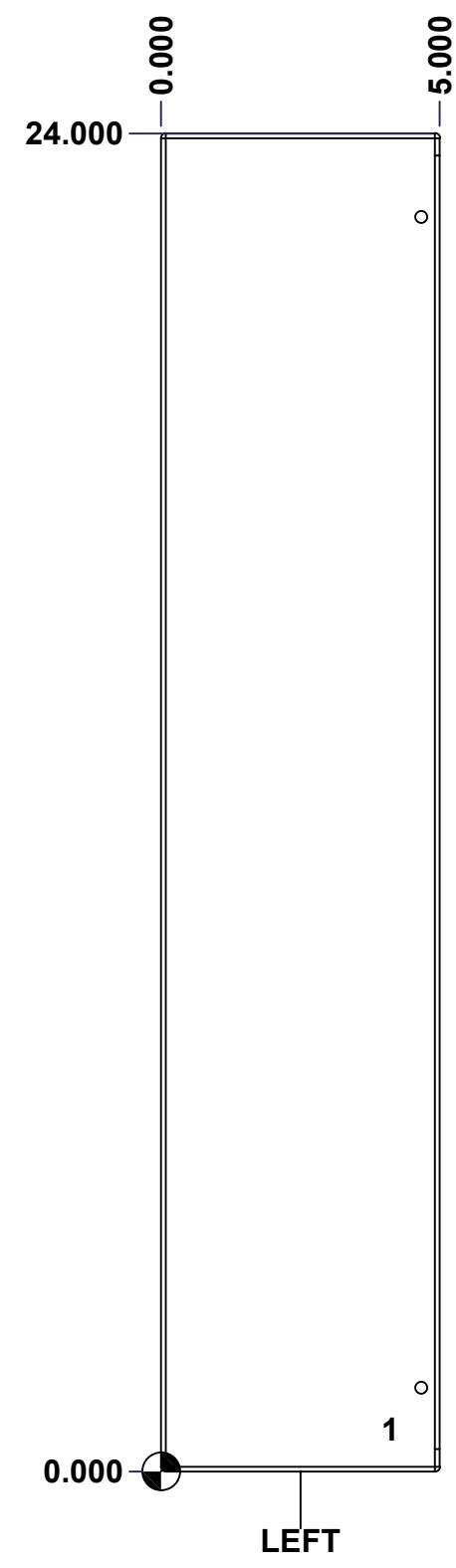

	Description 1412CH 24" x 8" x 5" Body	Status (NULL)
	Part Number Numéro Pièce 1412CH080524IPB	Rev. 4 0 / 11

This drawing is confidential and must not be reproduced or used without the consent of EXM

Ce dessin est confidentiel et ne doit pas être reproduit ou utilisé sans le consentement de EXM

STANDARD FEATURES ARE NOT LISTED IN THIS HOLE TABLE

HOLE TABLE - BACK VIEW (CUSTOM FEATURE ONLY)

CUT-OUT	XDIM	YDIM	DESCRIPTION
1	0.875	1.375	IP STANDOFF M6 x 10mm (Inside)
2	0.875	22.625	IP STANDOFF M6 x 10mm (Inside)
3	7.125	1.375	IP STANDOFF M6 x 10mm (Inside)
4	7.125	22.625	IP STANDOFF M6 x 10mm (Inside)

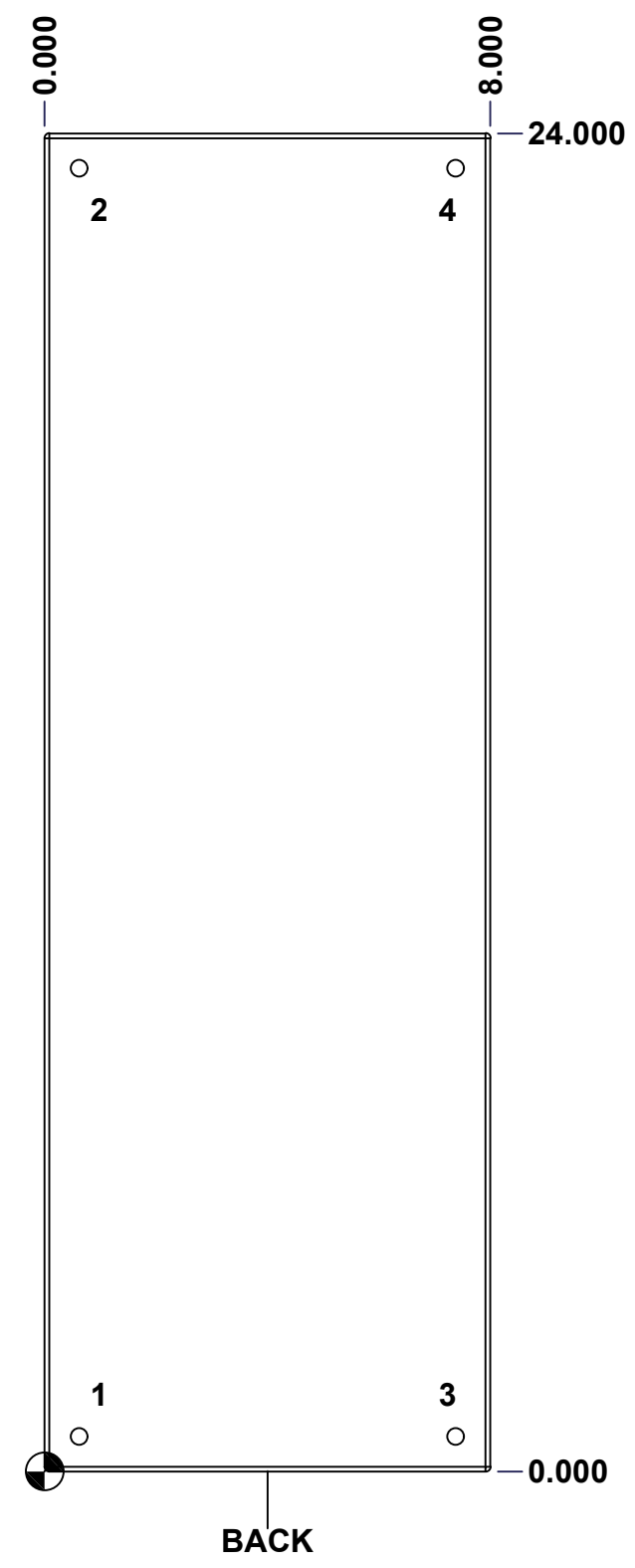

	Description	Status
	1412CH 24" x 8" x 5" Body	(NULL)
Part Number Numéro Pièce	1412CH080524IPB	Rev. 5
		0
		11

This drawing is confidential and must not be reproduced or used without the consent of EXM

Ce dessin est confidentiel et ne doit pas être reproduit ou utilisé sans le consentement de EXM

No.	Revisions	Date	By/Par

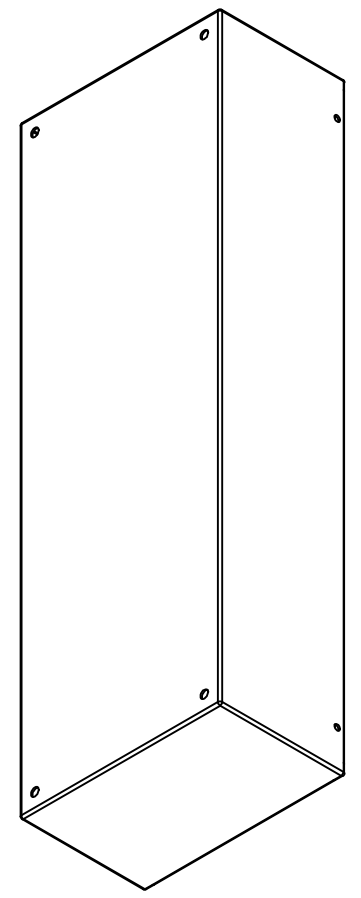

Isometric View

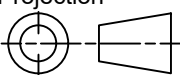

 Tél: (450) 979-4373 Fax: (450) 979-4626 www.exmweb.com		Flatness Aplatissement Max 3.0mm
Customer Client		Projection 
Drawn By Dessiné Par BoxCad: BoxCad		Date 02-Sep-25
Material Matière 16 Ga Cold Rolled A1008 CS Type B (1.4mm)		
Color Couleur Asa-61 Grey	Finish Fini Smooth	
Description 1412CH 24" x 8" x 5" Body		Detail Rev.
Part Number Numéro Pièce 1412CH080524IPB		Rev. 6 0

Qty	Part Number	Rev	Description
1	STK-P-02400S	0	Powder Paint (Asa-61 Grey / Smooth)
1	1412CH080524IPB-P	0	1412CH 24" x 8" x 5" Body Part
5	STK-Q-08350	5	Standoff M6 x 10mm
Parts List			

This drawing is confidential and must not be reproduced or used without the consent of EXM

Ce dessin est confidentiel et ne doit pas être reproduit ou utilisé sans le consentement de EXM

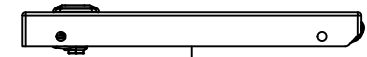

TOP

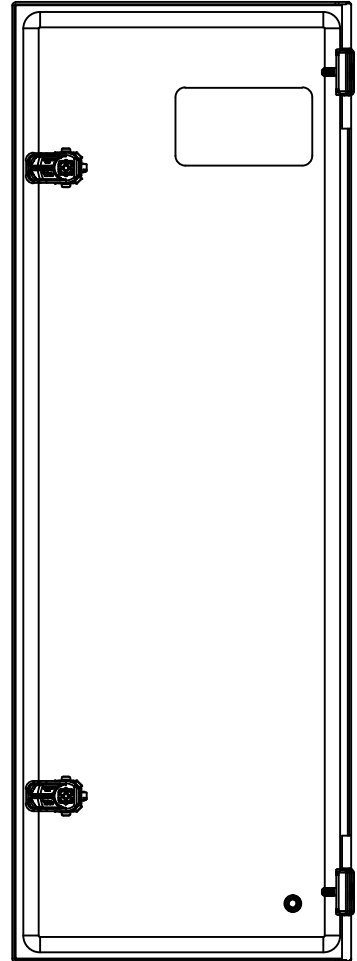

BACK

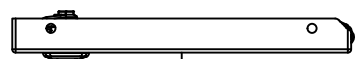

BOTTOM

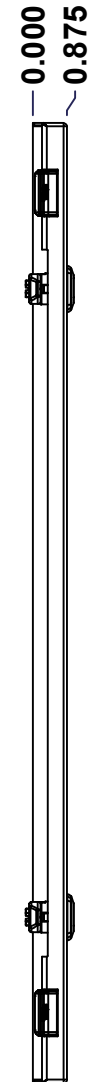

LEFT

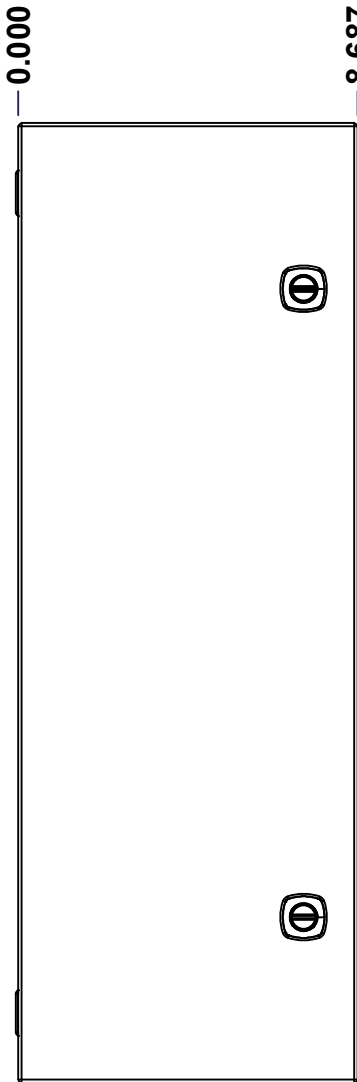

FRONT

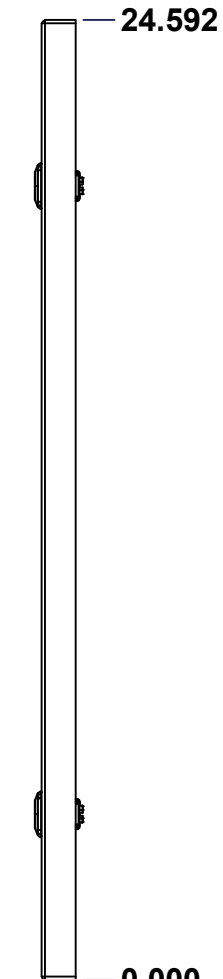

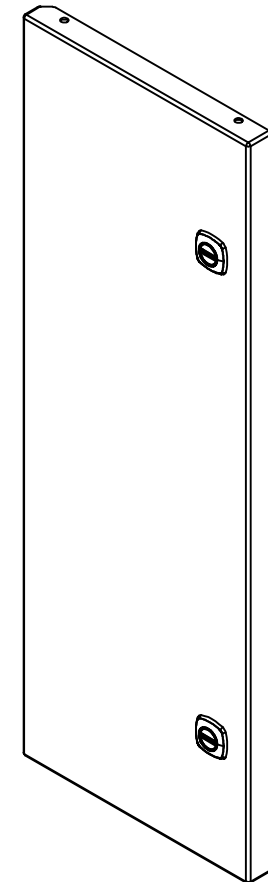

RIGHT



Isometric View

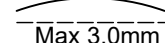

No.	Revisions	Date	By/Par

 Tél: (450) 979-4373 Fax: (450) 979-4626 www.exmweb.com		Flatness Aplatissement  Max 3.0mm Projection 
Customer Client	Date	
Drawn By Dessiné Par	BoxCad: BoxCad	Date 02-Sep-25
Material Matière	16 Ga Cold Rolled A1008 CS Type B (1.4mm)	
Color Couleur	Asa-61 Grey	Finish Fini Smooth
Description	Detail Rev.	
1412CH 24" x 8" Cover		
Part Number Numéro Pièce	Rev.	7
1412CH080524IPC	0	11

SEE BILL OF MATERIAL ON LAST PAGE

This drawing is confidential and must not be reproduced or used without the consent of EXM

Ce dessin est confidentiel et ne doit pas être reproduit ou utilisé sans le consentement de EXM

STANDARD FEATURES ARE NOT LISTED IN THIS HOLE TABLE			
HOLE TABLE - FRONT VIEW (CUSTOM FEATURE ONLY)			
CUT-OUT	XDIM	YDIM	DESCRIPTION
1	1.500	1.500	STANDOFF M6 x 10mm (Inside)
2	7.307	4.250	LOCK 880 SCQ4CH-SL @ 0.0°
3	7.307	20.342	LOCK 880 SCQ4CH-SL @ 0.0°

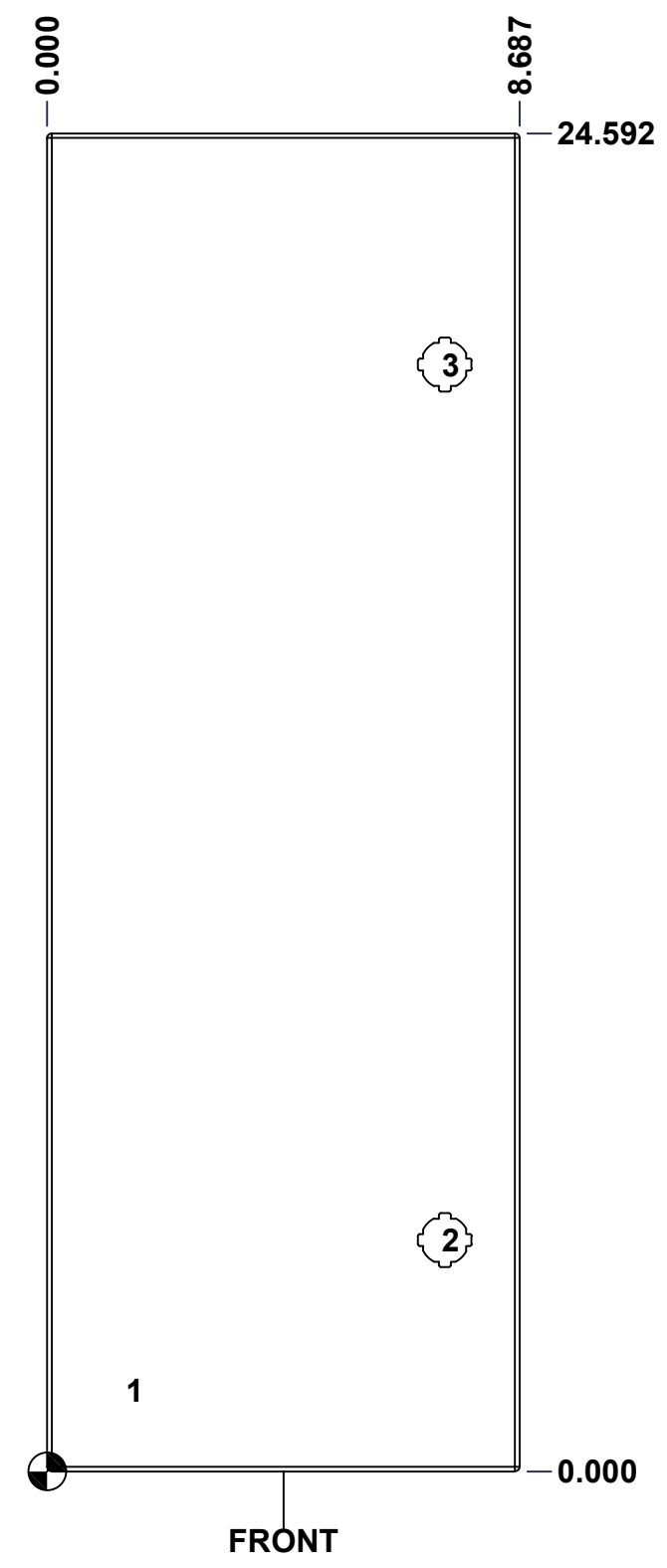

	Description	Status
	1412CH 24" x 8" Cover	(NULL)
Part Number Numéro Pièce 1412CH080524IPC	Rev.	8
	0	11

This drawing is confidential and must not be reproduced or used without the consent of EXM

Ce dessin est confidentiel et ne doit pas être reproduit ou utilisé sans le consentement de EXM

No.	Revisions	Date	By/Par

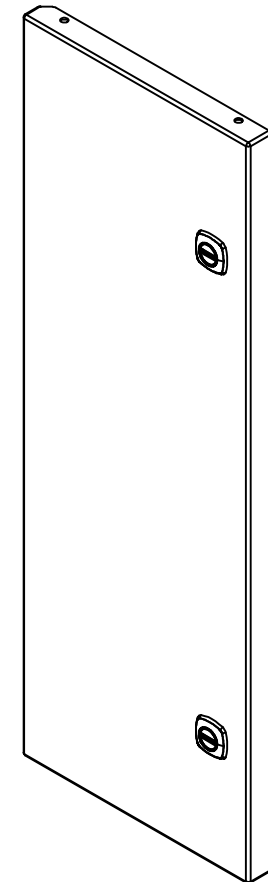

Isometric View

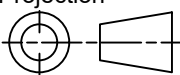

 Tél: (450) 979-4373 Fax: (450) 979-4626 www.exmweb.com		Flatness Aplatissement Max 3.0mm Projection 
Customer Client	Date	
Drawn By Dessiné Par	BoxCad: BoxCad	Date 02-Sep-25
Material Matière	16 Ga Cold Rolled A1008 CS Type B (1.4mm)	
Color Couleur	Asa-61 Grey	Finish Fini Smooth
Description		Detail Rev.
1412CH 24" x 8" Cover		
Part Number Numéro Pièce	Rev.	9
1412CH080524IPC	0	11

QTY	Part Number	Rev	Description
2	880 SCQ4CH-SL	0	5412 CH 1/4 Turn Lock
1	STK-Q-08350	5	Standoff M6 x 10mm
1	STK-P-02400S	0	Powder Paint (Asa-61 Grey / Smooth)
1	STK-S-00100	0	3.5" x 2" Silver Milar Flexcon Sticker
2	STK-A-33033	6	5412 ESCH Hinge Assembly
1	1412CH080524IPG	0	1412CH 24" x 8" Gasket
1	1412CH080524IPC-P	0	1412CH 24" x 8" Cover Part
Parts List			

This drawing is confidential and must not be reproduced or used without the consent of EXM

Ce dessin est confidentiel et ne doit pas être reproduit ou utilisé sans le consentement de EXM



TOP

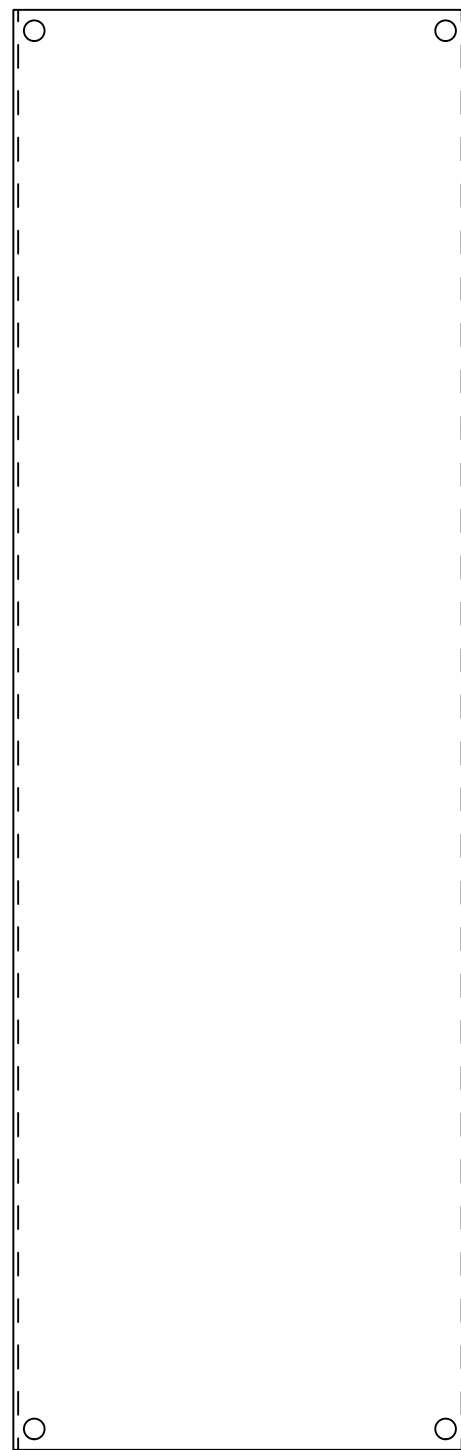

FRONT

21.880



0.000

RIGHT

SEE BILL OF MATERIAL ON LAST PAGE

No.	Revisions	Date	By/Par

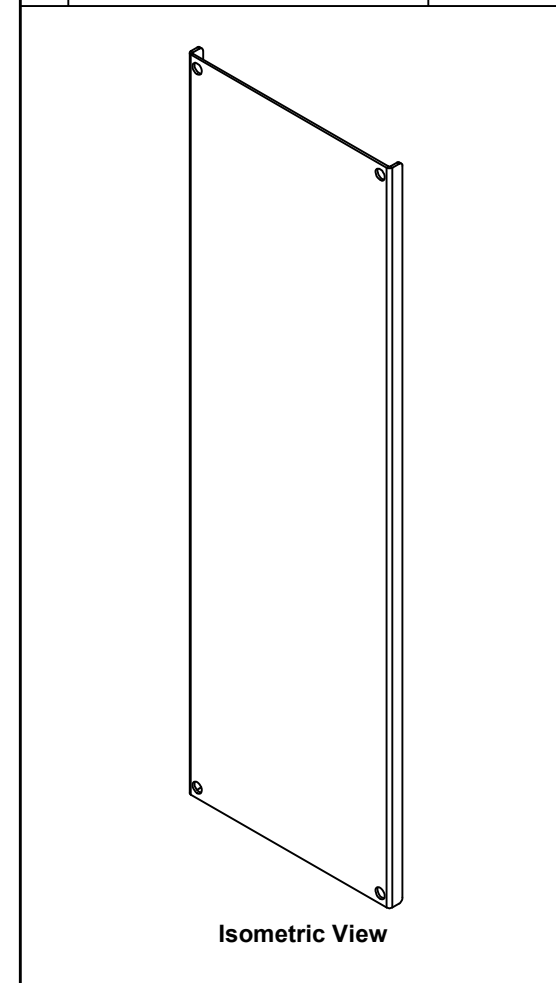

Isometric View

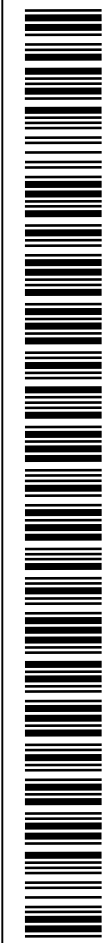



<p>Tél: (450) 979-4373 Fax: (450) 979-4626 www.exmweb.com</p>	Flatness Aplatissement	Max 3.0mm
	Projection	
Customer Client	Date	
Drawn By Dessiné Par	BoxCad: BoxCad	Date 02-Sep-25
Material Matière	14 Ga Galvanized (1.7mm)	
Color Couleur	Unpainted	Finish Fini Unpainted
Description	Detail Rev.	
1412CH 24" x 8" Inner Panel Part		
Part Number Numéro Pièce	Rev.	10
1412CH080524PIP	0	11

This drawing is confidential and must not be reproduced or used without the consent of EXM

Ce dessin est confidentiel et ne doit pas être reproduit ou utilisé sans le consentement de EXM

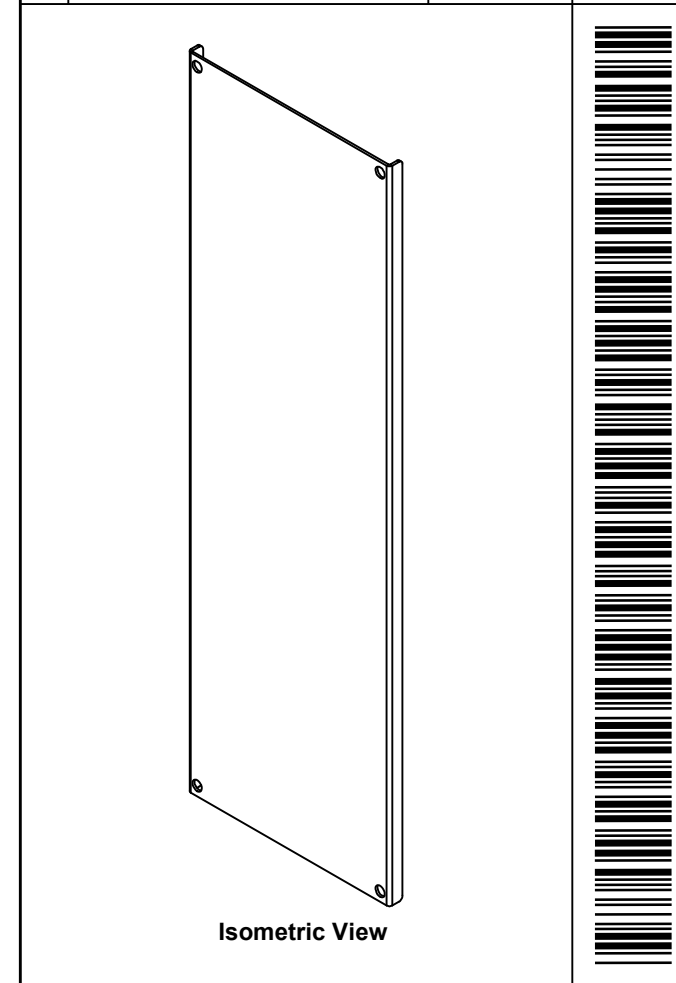
No.	Revisions	Date	By/Par

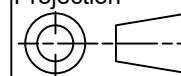

 Tél: (450) 979-4373 Fax: (450) 979-4626 www.exmweb.com		Flatness Aplatissement Max 3.0mm
Customer Client		Projection 
Drawn By / Dessiné Par: BoxCad: BoxCad		Date: 02-Sep-25
Material / Matière: 14 Ga Galvanized (1.7mm)		
Color / Couleur: Unpainted	Finish / Fini: Unpainted	
Description: 1412CH 24" x 8" Inner Panel Part		Detail Rev.
Part Number / Numéro Pièce: 1412CH080524PIP		Rev. 0 / 11

Qty	Part Number	Rev	Description
1	1412CH080524PIP-P	0	1412CH 24" x 8" Inner Panel Part
Parts List			