

This drawing is confidential and must not be reproduced or used without the consent of EXM

Ce dessin est confidentiel et ne doit pas être reproduit ou utilisé sans le consentement de EXM

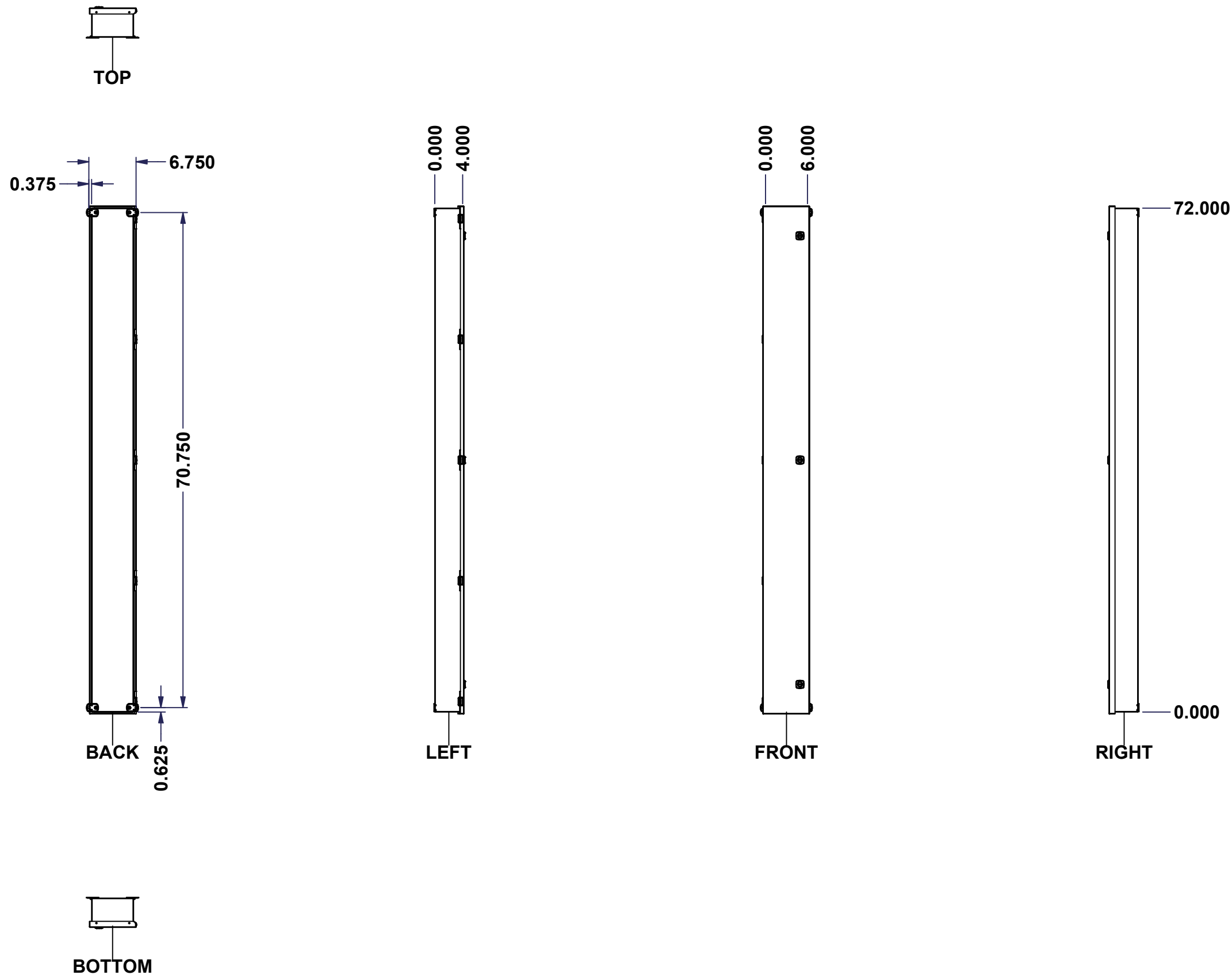

No.	Revisions	Date	By/Par

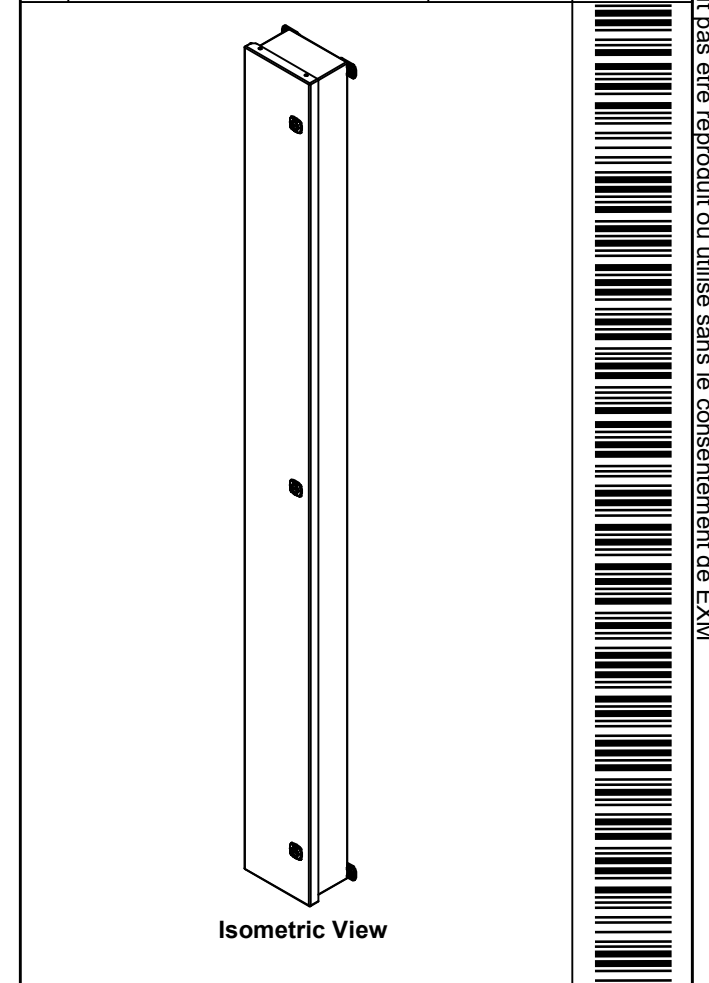

Tél: (450) 979-4373 Fax: (450) 979-4626 www.exmweb.com		Flatness Aplatissement Max 3.0mm Projection
Customer Client	Date	
Drawn By Dessiné Par	BoxCad: BoxCad	Date 18-Mar-16
Material Matière	16 Ga Stainless Steel 304 (1.4mm)	
Color Couleur	Asa-61 Grey	Finish Fini Smooth
Description	Detail Rev.	
1412CH 72" x 6" x 4" Assembly		
Part Number Numéro Pièce	Rev. 0	1 / 11

SEE BILL OF MATERIAL ON LAST PAGE

1412CHSSP060472IP

This drawing is confidential and must not be reproduced or used without the consent of EXM

Ce dessin est confidentiel et ne doit pas être reproduit ou utilisé sans le consentement de EXM

NOTE	
ITEM	DESCRIPTION
1	4X Enclosure (IP66)
2	C/W Standard ground standoffs on box and cover
3	W/O Standard door stiffener
4	C/W Special inner panel (Sold separately)
5	C/W Standard inner panel mounting standoffs

No.	Revisions	Date	By/Par

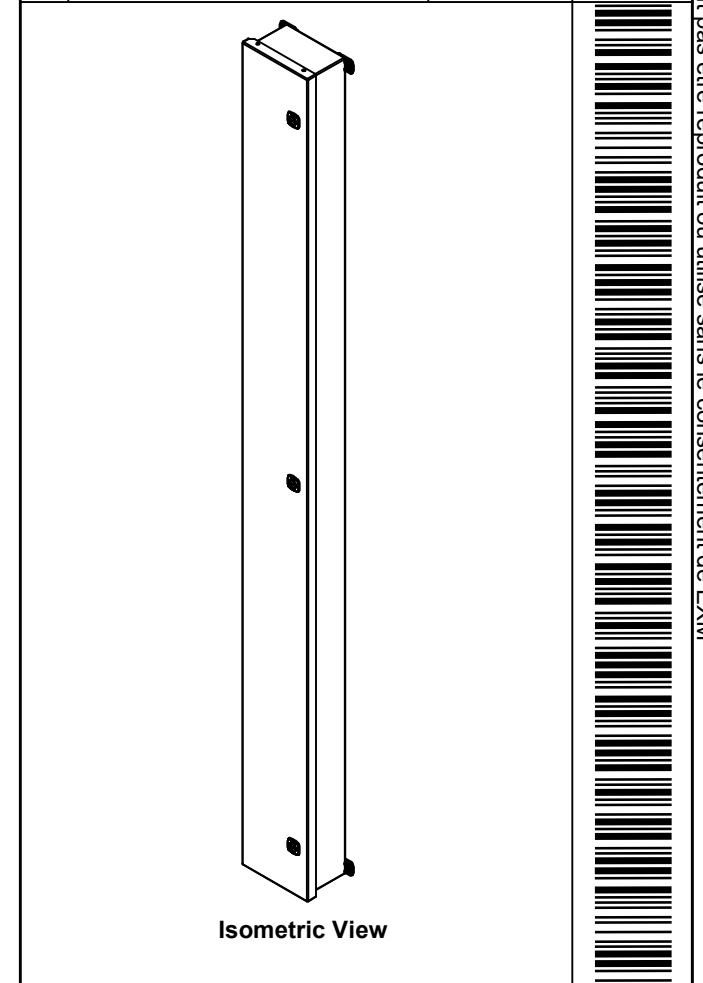

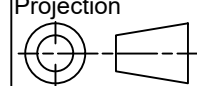
 Tél: (450) 979-4373 Fax: (450) 979-4626 www.exmweb.com	Flatness Aplatissement
	Max 3.0mm
Projection	
Customer Client	Date
Drawn By Dessiné Par BoxCad: BoxCad	Date 18-Mar-16
Material Matière	16 Ga Stainless Steel 304 (1.4mm)

5	STK-A-08126	0	M5 Stainless Steel 316 Nylon Insert Lock Nut with Incorporated Sealing Washer
1	1412CHSSP060472IPC	0	1412CH 72" x 6" Cover
1	1412CHSSP060472IPI	0	1412CH 72" x 6" Inner Panel Part
1	1412CHSSP060472IPB	0	1412CH 72" x 6" x 4" Body
2	STK-K-02575	0	1412 CHSS Accessory Kit
Qty	Part Number	Rev	Description
Parts List			

PACKING		
ITEM	QTY	DESCRIPTION
Cardboard sleeve	1	Top
Thermal plastic film	1	Use with Packing Tunnel Wrapper Machine
Packaging label	1	White label with product number

Color Couleur	Asa-61 Grey	Finish Fini	Smooth
Description	1412CH 72" x 6" x 4" Assembly		Detail Rev.
Part Number Numéro Pièce	1412CHSSP060472IP		Rev. 2
			0
			11

This drawing is confidential and must not be reproduced or used without the consent of EXM

Ce dessin est confidentiel et ne doit pas être reproduit ou utilisé sans le consentement de EXM

TOP

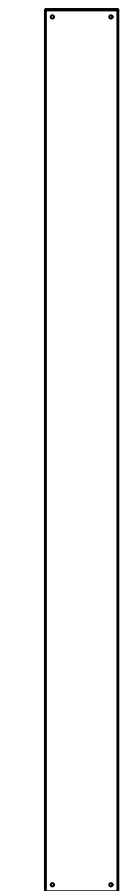

BACK

BOTTOM

0.000
4.000

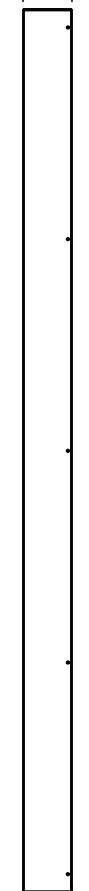

LEFT

0.000
6.000

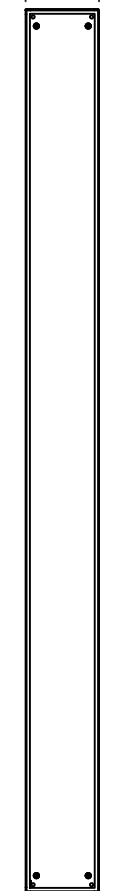

FRONT

72.000

0.000

RIGHT

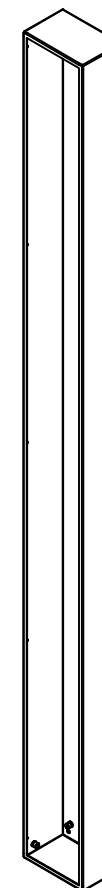

Isometric View

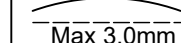
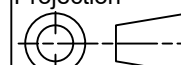

No.	Revisions	Date	By/Par

 Tél: (450) 979-4373 Fax: (450) 979-4626 www.exmweb.com		Flatness Aplatissement  Max 3.0mm Projection 
Customer Client	Date	
Drawn By Dessiné Par	BoxCad: BoxCad	Date 18-Mar-16
Material Matière	16 Ga Stainless Steel 304 (1.4mm)	
Color Couleur	Asa-61 Grey	Finish Fini Smooth
Description	Detail Rev.	
1412CH 72" x 6" x 4" Body		
Part Number Numéro Pièce	Rev.	3
SEE BILL OF MATERIAL ON LAST PAGE	1412CHSSP060472IPB	0

SEE BILL OF MATERIAL ON LAST PAGE

1412CHSSP060472IPB

Rev. 0 / 3 / 11

This drawing is confidential and must not be reproduced or used without the consent of EXM

Ce dessin est confidentiel et ne doit pas être reproduit ou utilisé sans le consentement de EXM

STANDARD FEATURES ARE NOT LISTED IN THIS HOLE TABLE			
HOLE TABLE - LEFT VIEW (CUSTOM FEATURE ONLY)			
CUT-OUT	XDIM	YDIM	DESCRIPTION
1	3.000	0.750	STANDOFF M6 x 10mm (Inside)

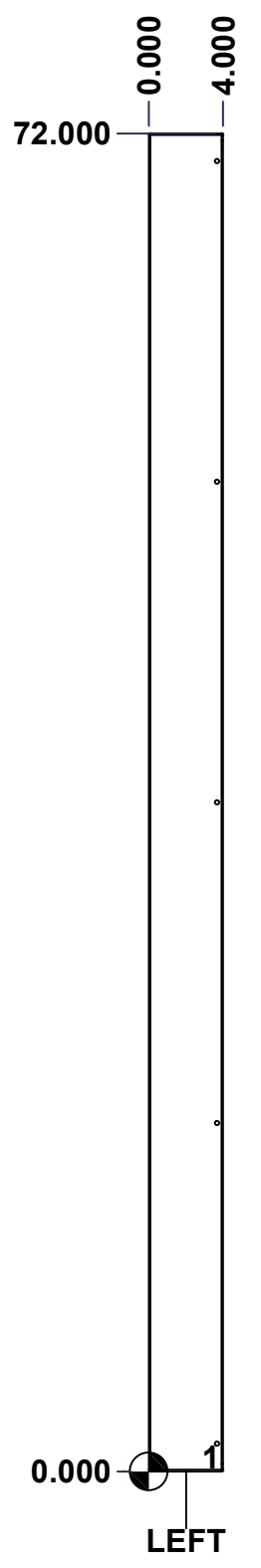

	Description	Status	
	1412CH 72" x 6" x 4" Body	(NULL)	
	Part Number Numéro Pièce	Rev.	
	1412CHSSP060472IPB	0	4 11

This drawing is confidential and must not be reproduced or used without the consent of EXM

Ce dessin est confidentiel et ne doit pas être reproduit ou utilisé sans le consentement de EXM

STANDARD FEATURES ARE NOT LISTED IN THIS HOLE TABLE			
HOLE TABLE - BACK VIEW (CUSTOM FEATURE ONLY)			
CUT-OUT	XDIM	YDIM	DESCRIPTION
1	0.875	1.375	IP STANDOFF M6 x 10mm (Inside)
2	0.875	70.625	IP STANDOFF M6 x 10mm (Inside)
3	5.125	1.375	IP STANDOFF M6 x 10mm (Inside)
4	5.125	70.625	IP STANDOFF M6 x 10mm (Inside)

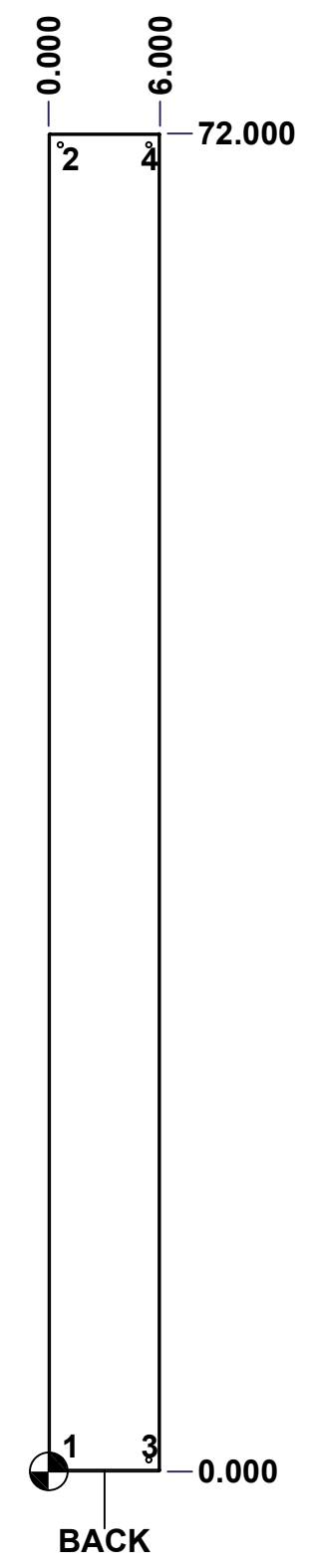

	Description	Status	
	1412CH 72" x 6" x 4" Body	(NULL)	
	Part Number Numéro Pièce	Rev.	5
	1412CHSSP060472IPB	0	11

This drawing is confidential and must not be reproduced or used without the consent of EXM

Ce dessin est confidentiel et ne doit pas être reproduit ou utilisé sans le consentement de EXM

No.	Revisions	Date	By/Par

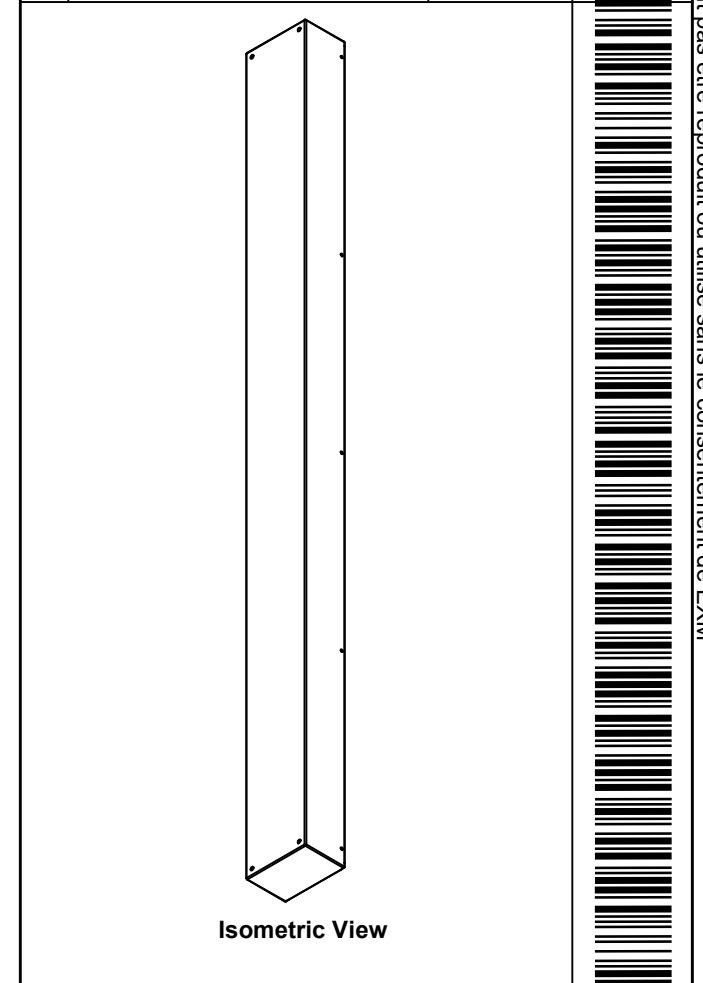

Isometric View

 Tél: (450) 979-4373 Fax: (450) 979-4626 www.exmweb.com		Flatness Aplatissement Max 3.0mm
Customer Client		Projection 
Drawn By / Dessiné Par: BoxCad: BoxCad		Date: 18-Mar-16
Material / Matière: 16 Ga Stainless Steel 304 (1.4mm)		
Color / Couleur: Asa-61 Grey	Finish / Fini: Smooth	
Description: 1412CH 72" x 6" x 4" Body		Detail Rev.
Part Number / Numéro Pièce: 1412CHSSP060472IPB		Rev. 6 0

Qty	Part Number	Rev	Description
1	STK-P-02400S	0	Powder Paint (Asa-61 Grey / Smooth)
1	1412CHSSP060472IPB-P	0	1412CH 72" x 6" x 4" Body Part
5	STK-Q-08500	4	Stainless Steel Standoff M6 x 10mm
Parts List			

This drawing is confidential and must not be reproduced or used without the consent of EXM

Ce dessin est confidentiel et ne doit pas être reproduit ou utilisé sans le consentement de EXM

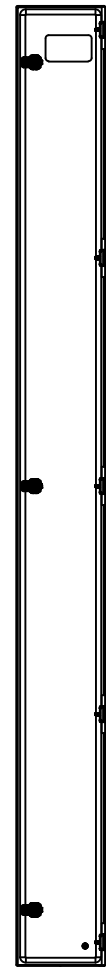

BACK



BOTTOM

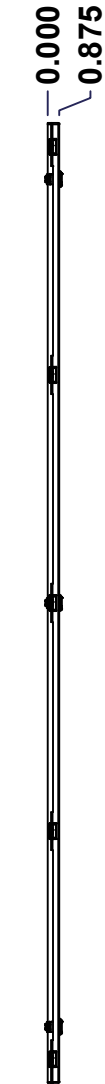

LEFT

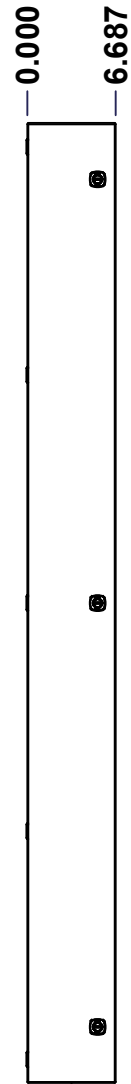

FRONT

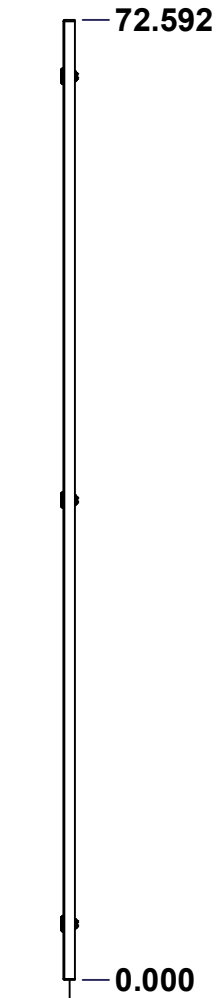

RIGHT

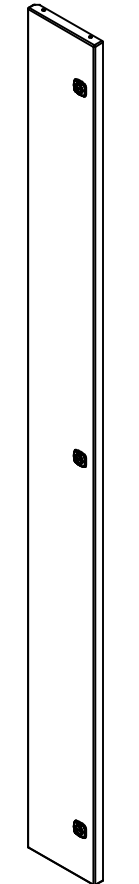

Isometric View



No.	Revisions	Date	By/Par

Tél: (450) 979-4373 Fax: (450) 979-4626 www.exmweb.com		Flatness Aplatissement Max 3.0mm Projection
Customer Client	Date	
Drawn By Dessiné Par	BoxCad: BoxCad	Date 18-Mar-16
Material Matière	16 Ga Stainless Steel 304 (1.4mm)	
Color Couleur	Asa-61 Grey	Finish Fini Smooth
Description	Detail Rev.	
1412CH 72" x 6" Cover		
Part Number Numéro Pièce	Rev.	7
1412CHSSP060472IPC	0	11

SEE BILL OF MATERIAL ON LAST PAGE

This drawing is confidential and must not be reproduced or used without the consent of EXM

Ce dessin est confidentiel et ne doit pas être reproduit ou utilisé sans le consentement de EXM

STANDARD FEATURES ARE NOT LISTED IN THIS HOLE TABLE			
HOLE TABLE - FRONT VIEW (CUSTOM FEATURE ONLY)			
CUT-OUT	XDIM	YDIM	DESCRIPTION
1	1.500	1.500	STANDOFF M6 x 10mm (Inside)
2	5.307	4.250	LOCK 880 SCQ4CH-SLSS @ 0.0°
3	5.307	36.296	LOCK 880 SCQ4CH-SLSS @ 0.0°
4	5.307	68.342	LOCK 880 SCQ4CH-SLSS @ 0.0°

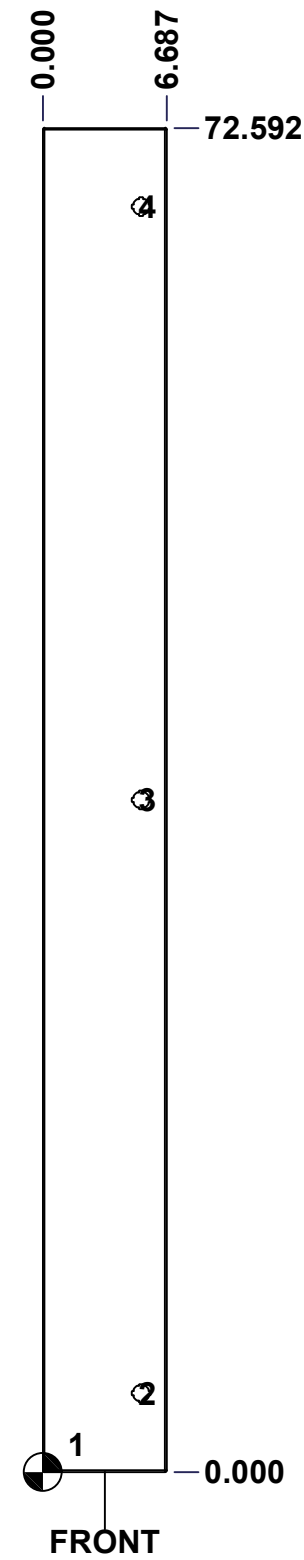

	Description	Status
	1412CH 72" x 6" Cover	(NULL)
	Part Number Numéro Pièce	Rev.
	1412CHSSP060472IPC	0
		8
		11

This drawing is confidential and must not be reproduced or used without the consent of EXM

Ce dessin est confidentiel et ne doit pas être reproduit ou utilisé sans le consentement de EXM

No.	Revisions	Date	By/Par

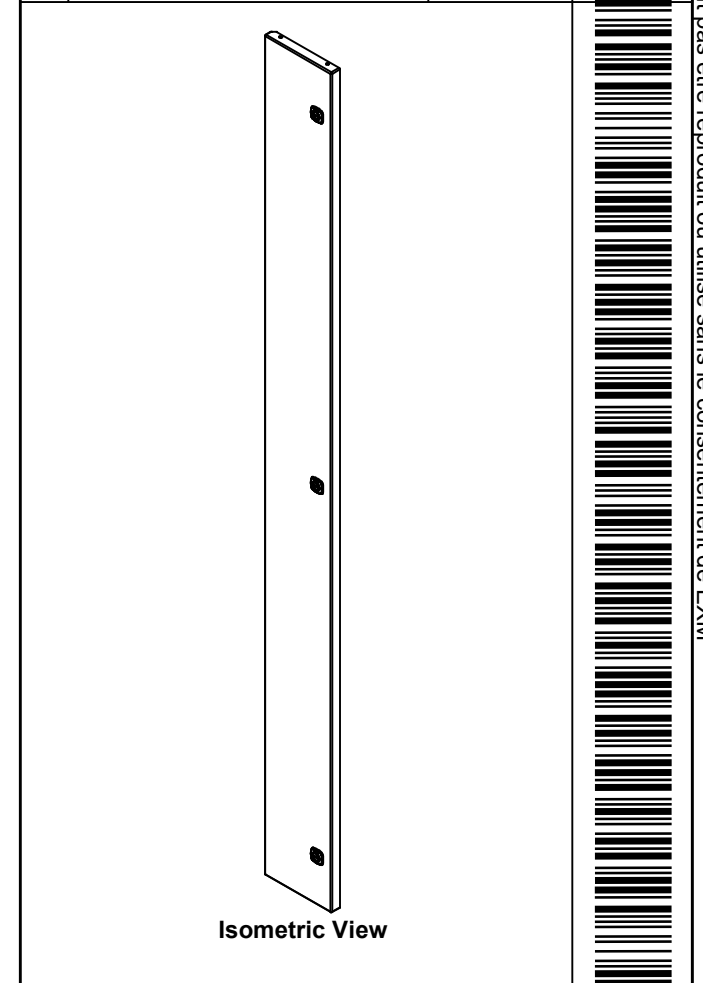

Tél: (450) 979-4373 Fax: (450) 979-4626 www.exmweb.com		Flatness Aplatissement
		Max 3.0mm
Customer Client		Date
Drawn By Dessiné Par BoxCad: BoxCad		Date 18-Mar-16
Material Matière 16 Ga Stainless Steel 304 (1.4mm)		
Color Couleur Asa-61 Grey	Finish Fini Smooth	
Description 1412CH 72" x 6" Cover		Detail Rev.
Part Number Numéro Pièce 1412CHSSP060472IPC		Rev. 0

3	880 SCQ4CH-SLSS	0	5412 CHSS 1/4 Turn Lock
1	STK-Q-08500	4	Stainless Steel Standoff M6 x 10mm
1	STK-P-02400S	0	Powder Paint (Asa-61 Grey / Smooth)
1	STK-S-00100	0	3.5" x 2" Silver Milar Flexcon Sticker
5	STK-A-33038	5	5412 ESSCH Hinge Assembly
1	1412CHSSP060472IPG	0	1412CH 72" x 6" Gasket
1	1412CHSSP060472IPC-P	0	1412CH 72" x 6" Cover Part
QTY	Part Number	Rev	Description
Parts List			

This drawing is confidential and must not be reproduced or used without the consent of EXM

Ce dessin est confidentiel et ne doit pas être reproduit ou utilisé sans le consentement de EXM

0.000
TOP
4.880

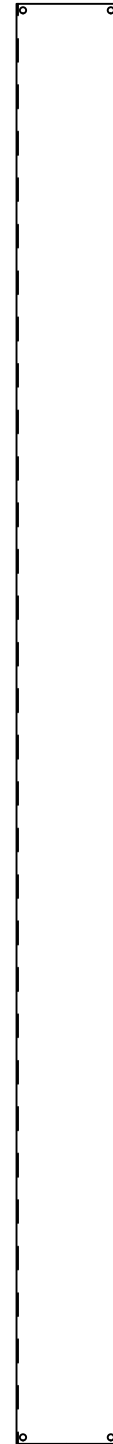

FRONT

69.880



RIGHT
0.000



Isometric View

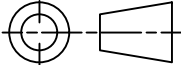

No.	Revisions	Date	By/Par

 Tél: (450) 979-4373 Fax: (450) 979-4626 www.exmweb.com		Flatness Aplatissement Max 3.0mm Projection 
Customer Client	Date	
Drawn By Dessiné Par	BoxCad: BoxCad	Date 18-Mar-16
Material Matière	14 Ga Galvanized (1.7mm)	
Color Couleur	Unpainted	Finish Fini Unpainted
Description	Detail Rev.	
1412CH 72" x 6" Inner Panel Part		
Part Number Numéro Pièce	Rev.	10
1412CHSSP060472IPI	0	11

SEE BILL OF MATERIAL ON LAST PAGE

This drawing is confidential and must not be reproduced or used without the consent of EXM

Ce dessin est confidentiel et ne doit pas être reproduit ou utilisé sans le consentement de EXM

No.	Revisions	Date	By/Par

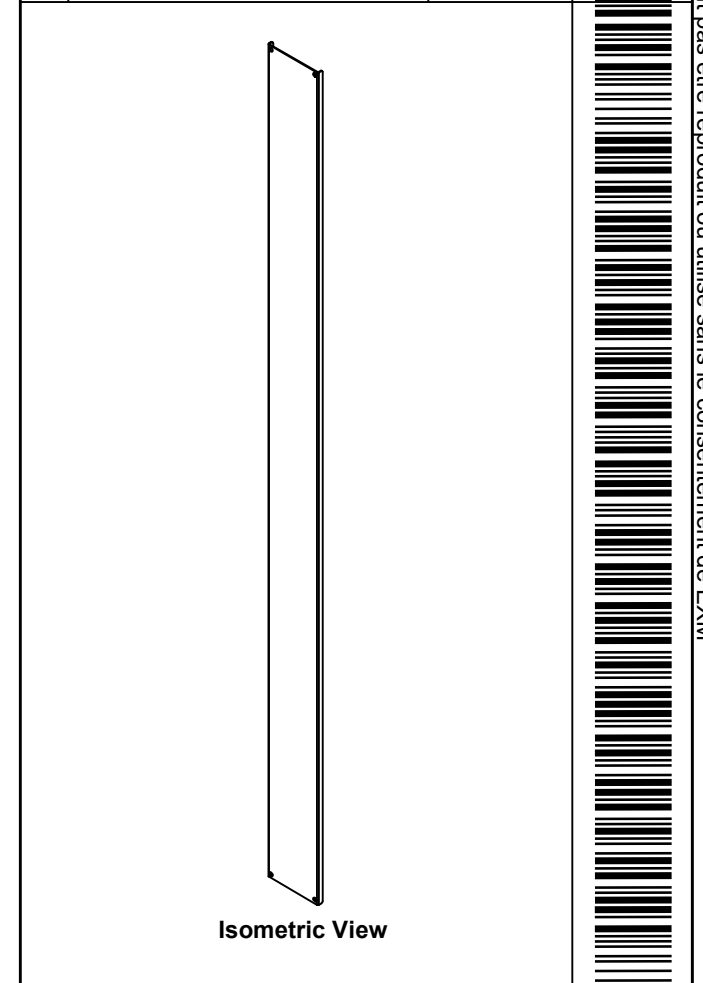

Isometric View

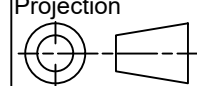
 Tél: (450) 979-4373 Fax: (450) 979-4626 www.exmweb.com		Flatness Aplatissement Max 3.0mm Projection 
Customer Client	Date	
Drawn By Dessiné Par	BoxCad: BoxCad	Date 18-Mar-16
Material Matière	14 Ga Galvanized (1.7mm)	
Color Couleur	Unpainted	Finish Fini Unpainted
Description	Detail Rev.	
1412CH 72" x 6" Inner Panel Part		
Part Number Numéro Pièce	Rev.	11
1412CHSSP060472IPIP	0	11

Qty	Part Number	Rev	Description
1	1412CHSSP060472IPIP-P	0	1412CH 72" x 6" Inner Panel Part
Parts List			