

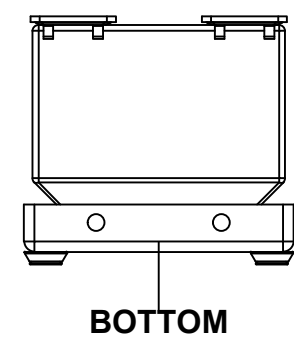

This drawing is confidential and must not be reproduced or used without the consent of EXM

Ce dessin est confidentiel et ne doit pas être reproduit ou utilisé sans le consentement de EXM

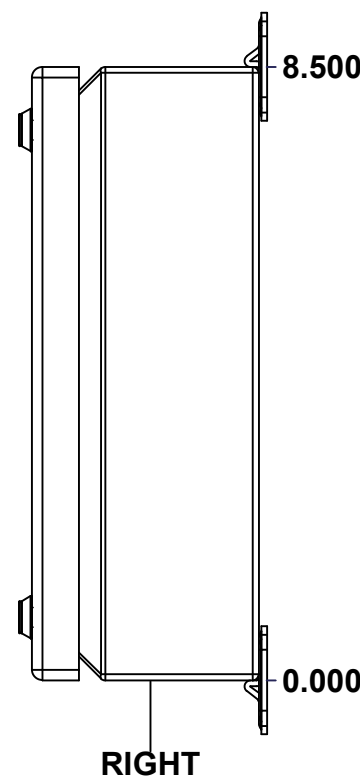
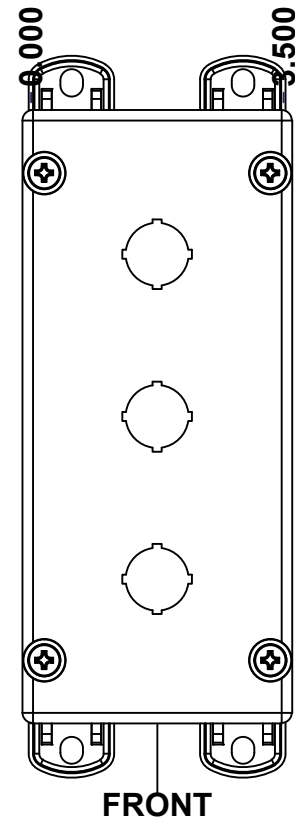
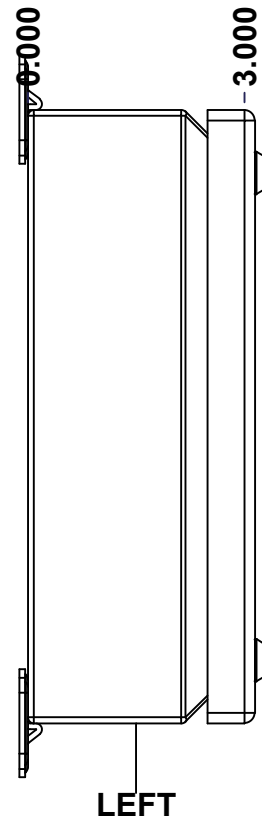
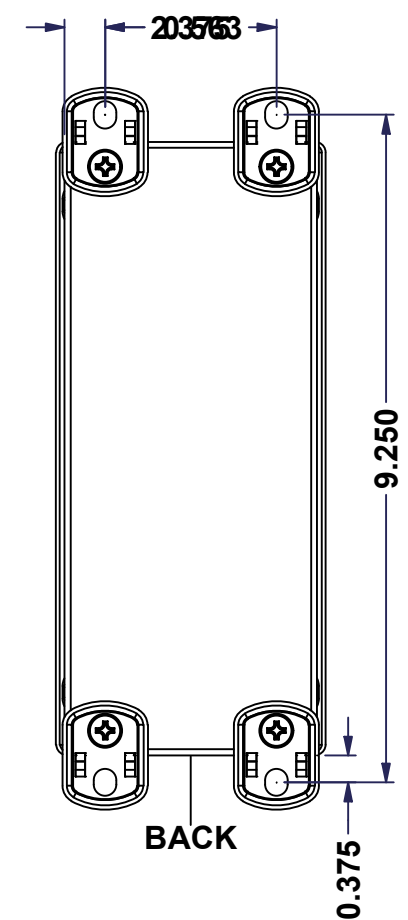
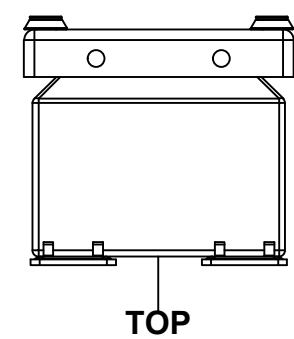
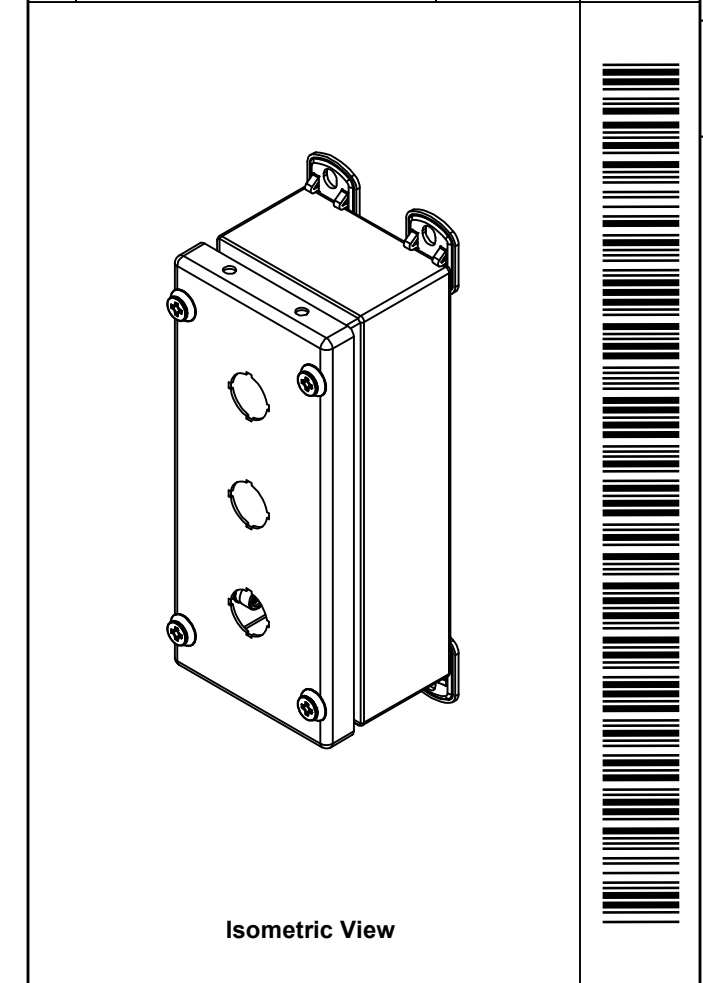

No.	Revisions	Date	By/Par

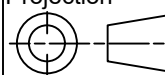

 Tél: (450) 979-4373 Fax: (450) 979-4626 www.exmweb.com		Flatness Aplatissement Max 3.0mm	
		Projection 	
Customer Client		Date	
Drawn By Dessiné Par BoxCad: BoxCad		Date 23-Feb-23	
Material Matière 16 Ga Cold Rolled A1008 CS Type B (1.4mm)			
Color Couleur Asa-61 Grey		Finish Fini Smooth	
Description 1412SDMN 8.5" x 3.5" x 3" Assembly			Detail Rev.
Part Number Numéro Pièce 1412SD080302MN		Rev. 0	1 9

SEE BILL OF MATERIAL ON LAST PAGE

This drawing is confidential and must not be reproduced or used without the consent of EXM

Ce dessin est confidentiel et ne doit pas être reproduit ou utilisé sans le consentement de EXM

NOTE	
ITEM	DESCRIPTION
1	NEMA 4, 12 Enclosure (IP66)
2	C/W Standard ground standoffs on box only
3	W/O Standard door stiffener
4	W/O Inner panel
5	W/O Inner panel mounting standoffs
6	C/W 885 ESCHMF1 Mounting Feet (Installed)

No.	Revisions	Date	By/Par

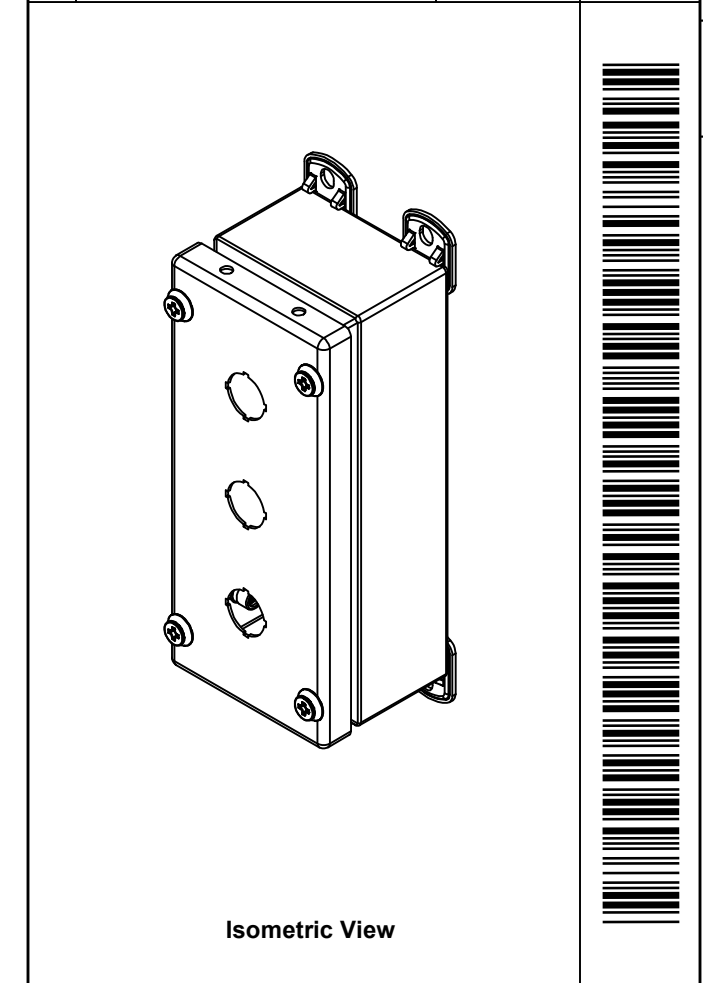

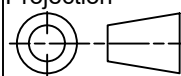
 Tél: (450) 979-4373 Fax: (450) 979-4626 www.exmweb.com	Flatness Aplatissement Max 3.0mm
	Projection 
Customer Client	Date
Drawn By Dessiné Par BoxCad: BoxCad	Date 23-Feb-23
Material Matière 16 Ga Cold Rolled A1008 CS Type B (1.4mm)	
Color Couleur Asa-61 Grey	Finish Fini Smooth
Description 1412SDMN 8.5" x 3.5" x 3" Assembly	
Part Number Numéro Pièce 1412SD080302MN	Rev. 2 0 9

PACKING		
ITEM	QTY	DESCRIPTION
Cardboard sleeve	2	Top and Bottom
Cardboard strip	2	Between back of enclosure and inner panel
Plastic bag	1	To protect cover surface and inside gasket
Plastic strap - Black	2	To Squeeze the 2 cardboard sleeve together
Packaging label	1	White label with product number

Qty	Part Number	Rev	Description
1	STK-K-02920	3	5412 ESSC Accessory Kit
1	1412SD080302MNC	0	1412SDMN 8.5" x 3.5" Cover
1	1412SD080302MNB	0	1412SDMN 8.5" x 3.5" x 3" Body
Parts List			

This drawing is confidential and must not be reproduced or used without the consent of EXM

Ce dessin est confidentiel et ne doit pas être reproduit ou utilisé sans le consentement de EXM

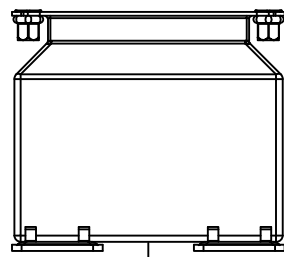

TOP

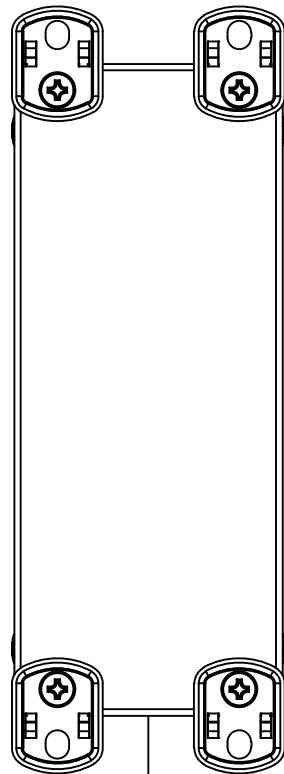

BACK

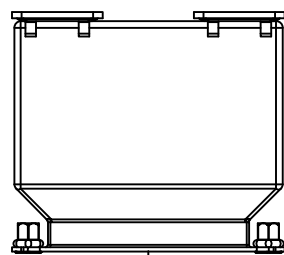

BOTTOM

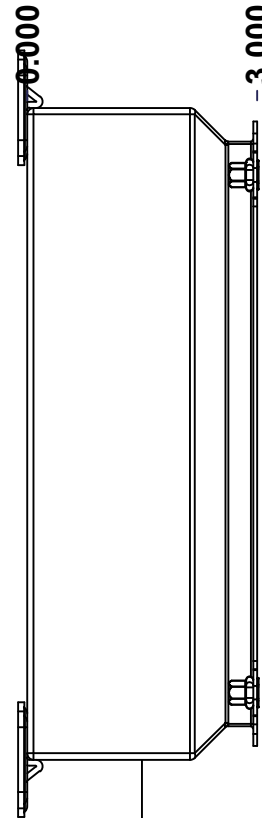

LEFT

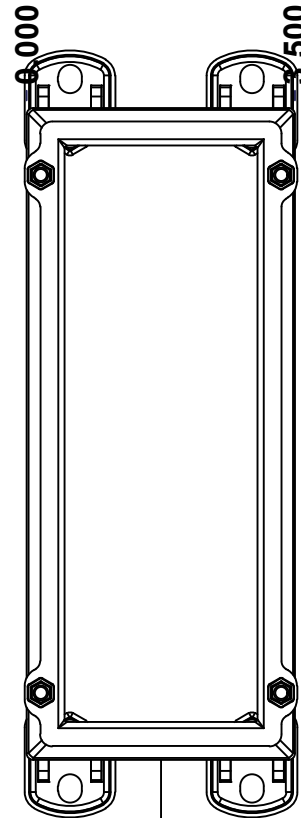

FRONT

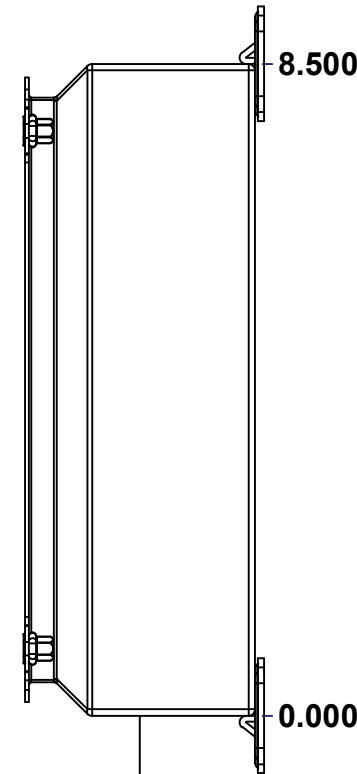

RIGHT

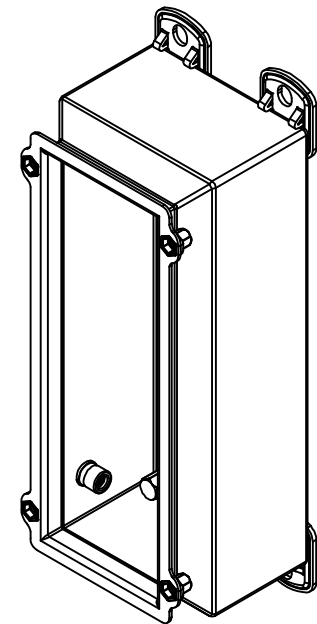

Isometric View

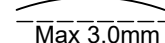
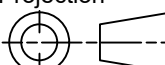

No.	Revisions	Date	By/Par

 Tél: (450) 979-4373 Fax: (450) 979-4626 www.exmweb.com		Flatness Aplatissement  Max 3.0mm Projection 
Customer Client	Date	
Drawn By Dessiné Par	BoxCad: BoxCad	Date 23-Feb-23
Material Matière	16 Ga Cold Rolled A1008 CS Type B (1.4mm)	
Color Couleur	Asa-61 Grey	Finish Fini Smooth
Description	Detail Rev.	
1412SDMN 8.5" x 3.5" x 3" Body		
Part Number Numéro Pièce	Rev.	3
1412SD080302MNB	0	9

SEE BILL OF MATERIAL ON LAST PAGE

This drawing is confidential and must not be reproduced or used without the consent of EXM

Ce dessin est confidentiel et ne doit pas être reproduit ou utilisé sans le consentement de EXM

STANDARD FEATURES ARE NOT LISTED IN THIS HOLE TABLE			
HOLE TABLE - LEFT VIEW (CUSTOM FEATURE ONLY)			
CUT-OUT	XDIM	YDIM	DESCRIPTION
1	1.625	0.875	STANDOFF M6 x 10mm (Inside)

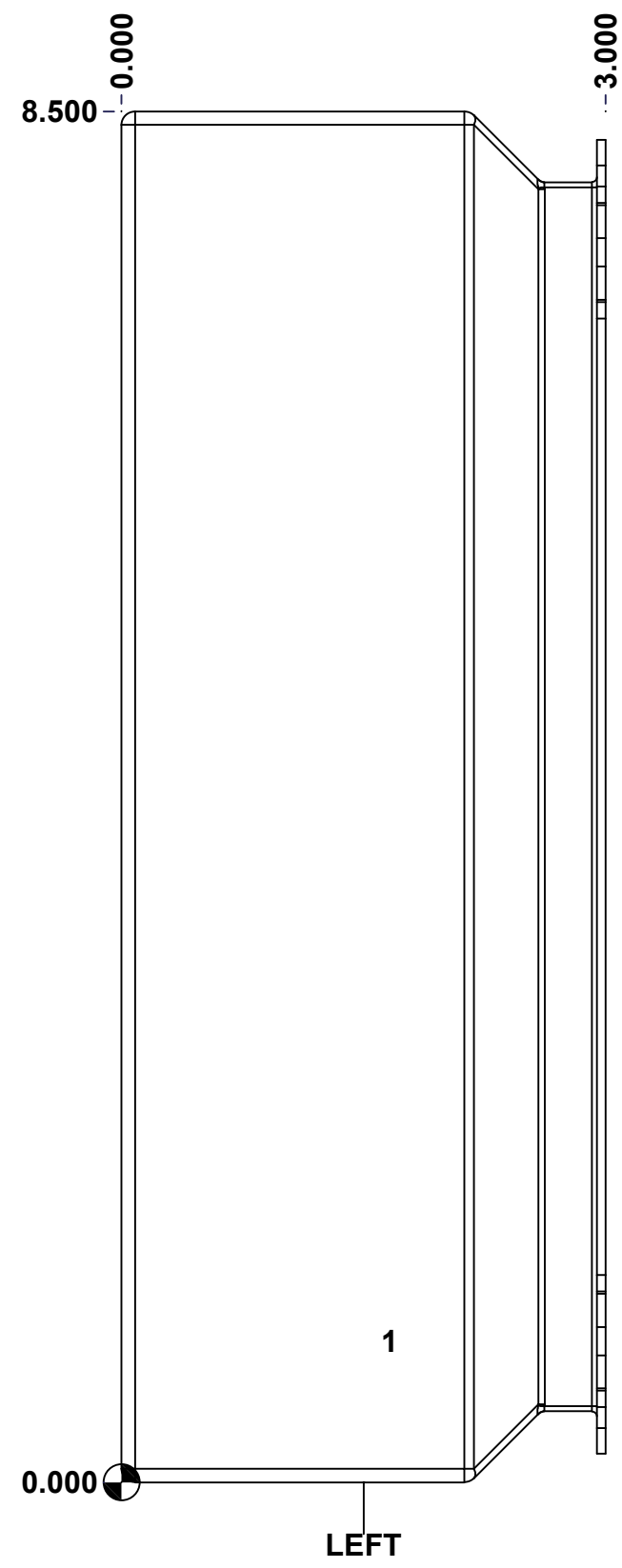

	Description	Status	
	1412SDMN 8.5" x 3.5" x 3" Body	(NULL)	
	Part Number Numéro Pièce	Rev.	
	1412SD080302MNB	0	4 9

This drawing is confidential and must not be reproduced or used without the consent of EXM

Ce dessin est confidentiel et ne doit pas être reproduit ou utilisé sans le consentement de EXM

STANDARD FEATURES ARE NOT LISTED IN THIS HOLE TABLE

HOLE TABLE - BACK VIEW (CUSTOM FEATURE ONLY)

CUT-OUT	XDIM	YDIM	DESCRIPTION
1	2.937	0.000	FOOT 885 ESCHMF1
2	0.563	0.000	FOOT 885 ESCHMF1
3	2.937	8.500	FOOT 885 ESCHMF1
4	0.563	8.500	FOOT 885 ESCHMF1
5	2.937	0.344	RIVET NUT M6_FH_CE (Inside)
6	0.563	0.344	RIVET NUT M6_FH_CE (Inside)
7	2.937	8.156	RIVET NUT M6_FH_CE (Inside)
8	0.563	8.156	RIVET NUT M6_FH_CE (Inside)

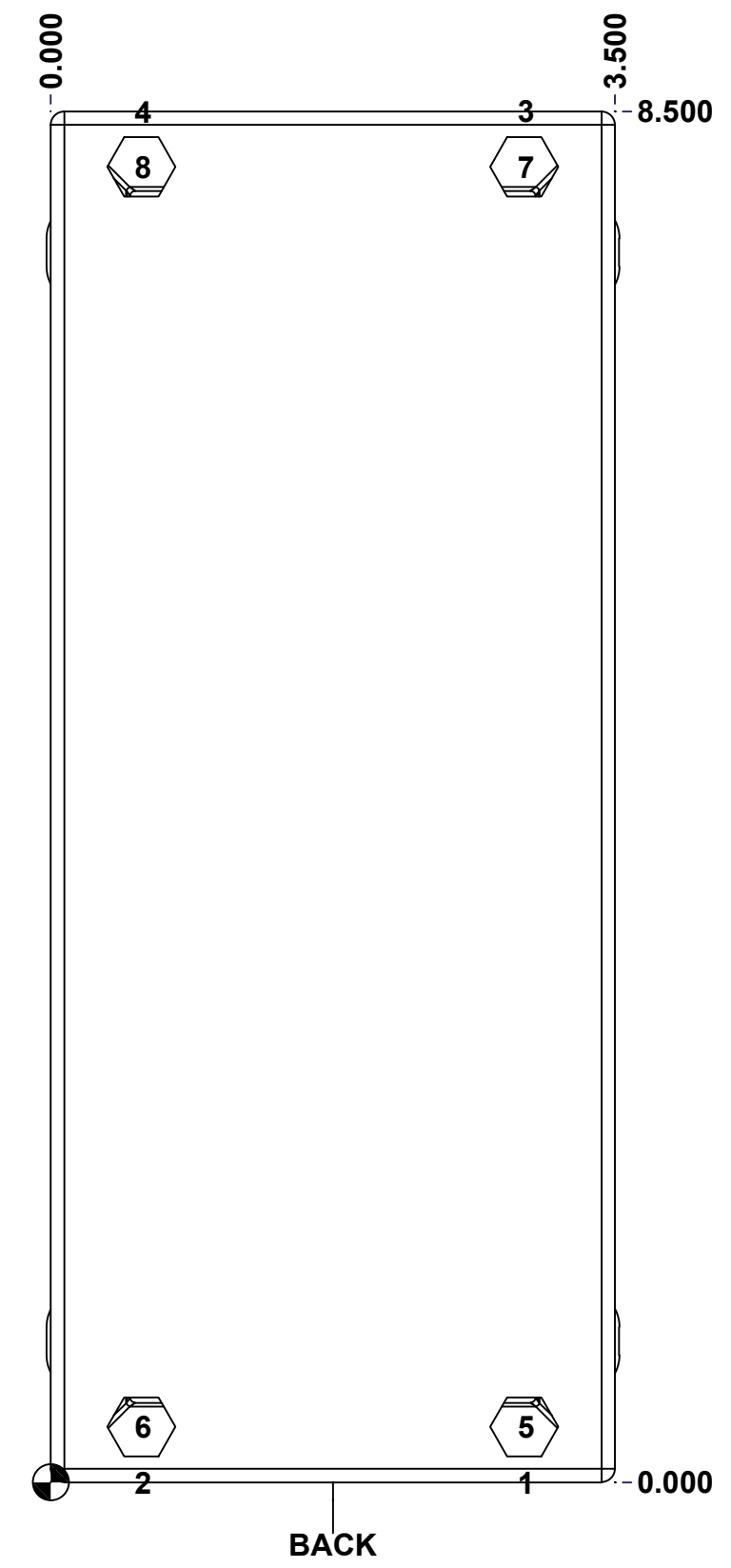

	Description	Status
	1412SDMN 8.5" x 3.5" x 3" Body	(NULL)
Part Number Numéro Pièce 1412SD080302MNB	Rev.	5
	0	9

This drawing is confidential and must not be reproduced or used without the consent of EXM

Ce dessin est confidentiel et ne doit pas être reproduit ou utilisé sans le consentement de EXM

No.	Revisions	Date	By/Par

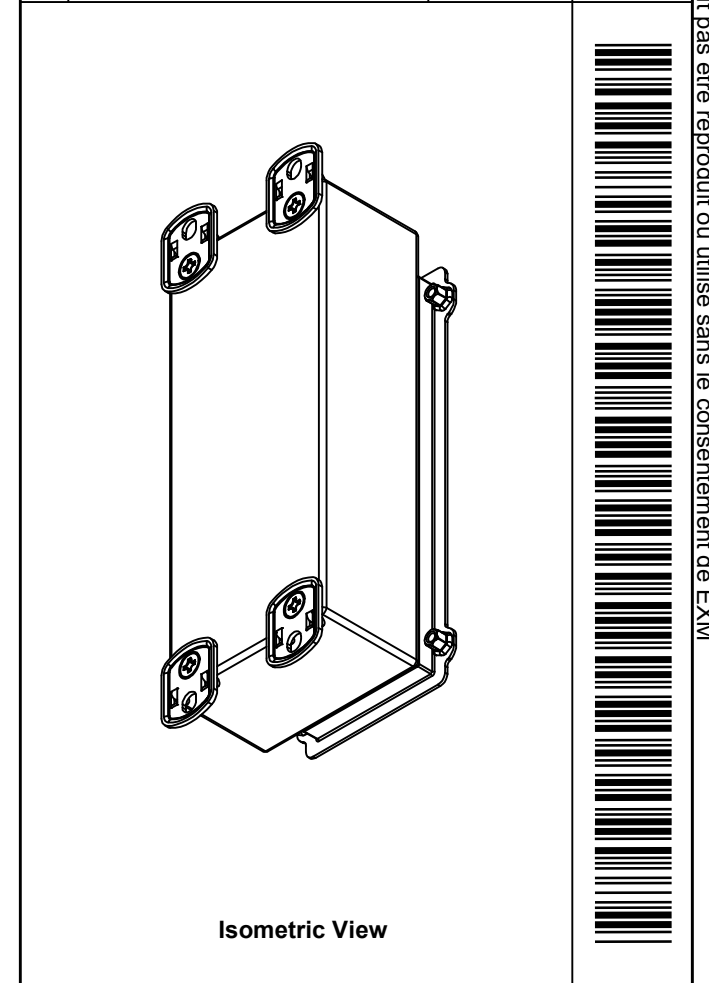

Tél: (450) 979-4373 Fax: (450) 979-4626 www.exmweb.com		Flatness Aplatissement
		Max 3.0mm
Customer Client		Date
Drawn By Dessiné Par BoxCad: BoxCad		Date 23-Feb-23
Material Matière 16 Ga Cold Rolled A1008 CS Type B (1.4mm)		
Color Couleur	Asa-61 Grey	Finish Fini Smooth
Description 1412SDMN 8.5" x 3.5" x 3" Body		Detail Rev.
Part Number Numéro Pièce 1412SD080302MNB		Rev. 6 0 9

Qty	Part Number	Rev	Description
4	STK-Q-03071	0	M6 x 16mm Machine Screw
4	RIVET_NUT_M6_FH_CE	0	Rivet Nut M6 (Low Profile Close End)
4	885 ESCHMF1	2	5412 ESCH Stamped Mounting Foot
1	STK-P-02400S	0	Powder Paint (Asa-61 Grey / Smooth)
1	1412SD080302MNB-P	0	1412SDMN 8.5" x 3.5" x 3" Body Part
1	STK-Q-08350	5	Standoff M6 x 10mm
4	RIVET_NUT_M5_FH_OE	0	Rivet Nut M5 (Low Profile Open End)
Parts List			

This drawing is confidential and must not be reproduced or used without the consent of EXM

Ce dessin est confidentiel et ne doit pas être reproduit ou utilisé sans le consentement de EXM

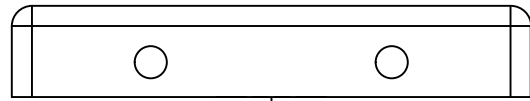

TOP

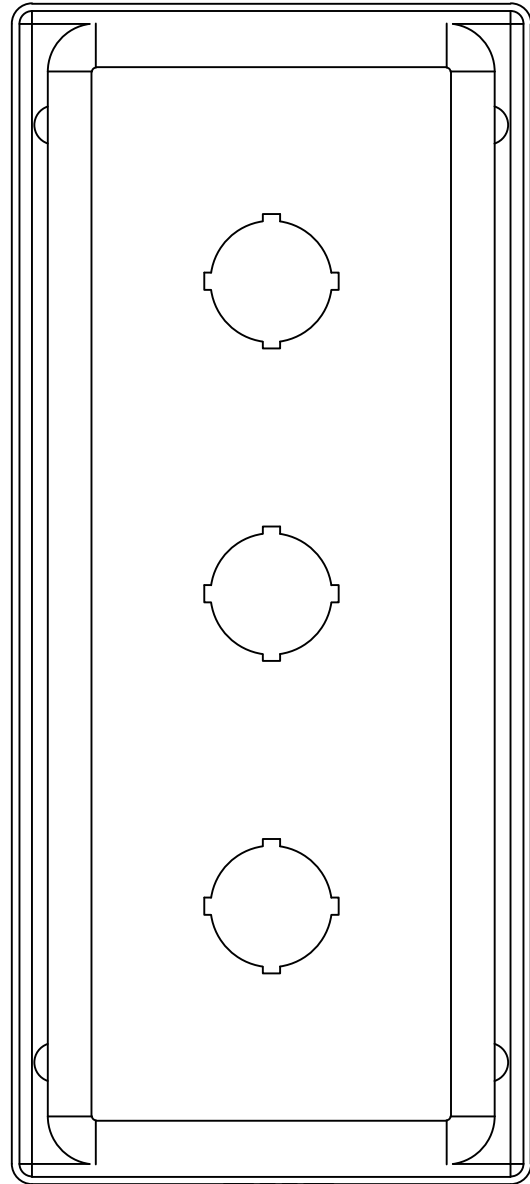

BACK

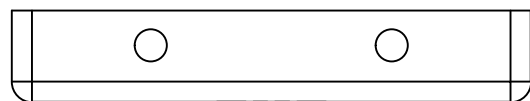

BOTTOM

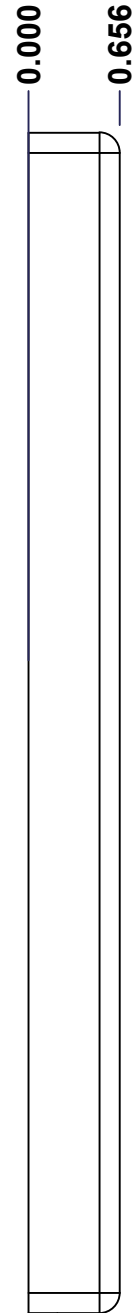

LEFT

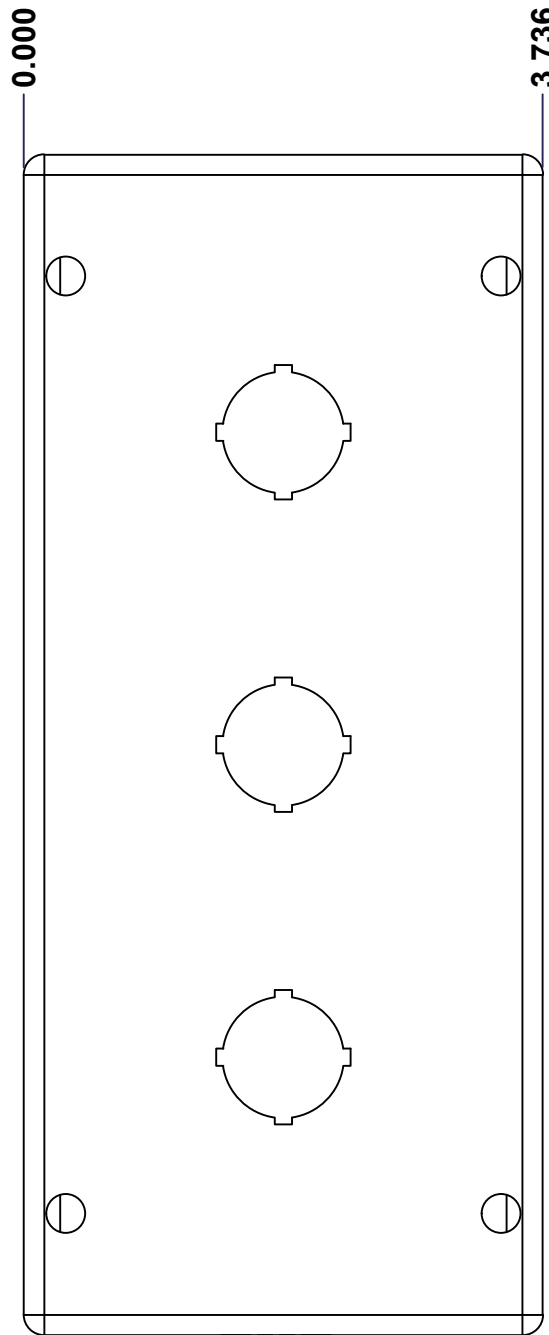

FRONT

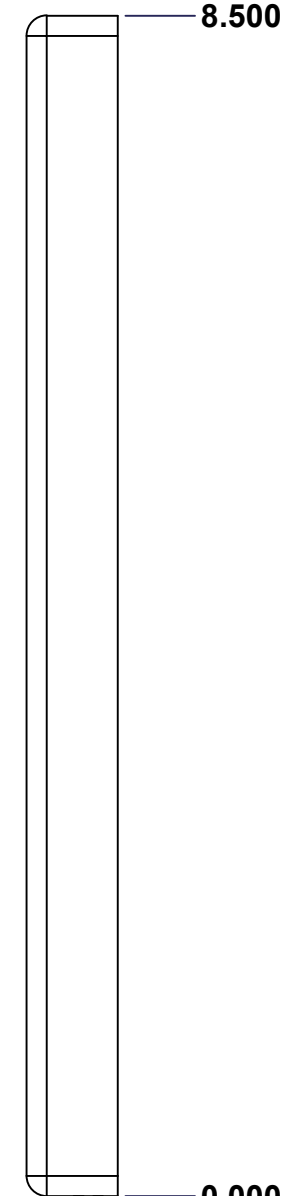

RIGHT

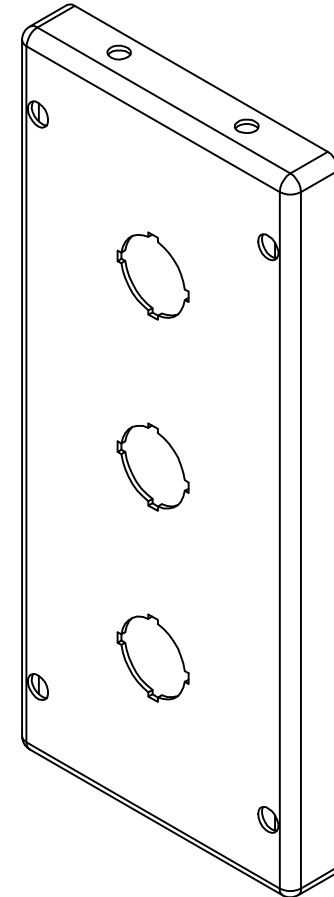

Isometric View

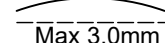
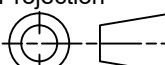

No.	Revisions	Date	By/Par

 Tél: (450) 979-4373 Fax: (450) 979-4626 www.exmweb.com		Flatness Aplatissement  Max 3.0mm Projection 
Customer Client	Date	
Drawn By Dessiné Par	BoxCad: BoxCad	Date 23-Feb-23
Material Matière	16 Ga Cold Rolled A1008 CS Type B (1.4mm)	
Color Couleur	Asa-61 Grey	Finish Fini Smooth
Description 1412SDMN 8.5" x 3.5" Cover		Detail Rev.
Part Number Numéro Pièce	1412SD080302MNC	Rev. 7 0

SEE BILL OF MATERIAL ON LAST PAGE

This drawing is confidential and must not be reproduced or used without the consent of EXM

Ce dessin est confidentiel et ne doit pas être reproduit ou utilisé sans le consentement de EXM

STANDARD FEATURES ARE NOT LISTED IN THIS HOLE TABLE

HOLE TABLE - FRONT VIEW (CUSTOM FEATURE ONLY)

CUT-OUT	XDIM	YDIM	DESCRIPTION
1	1.868	2.000	22.5 mm Miniature Pushbutton
2	1.868	4.250	22.5 mm Miniature Pushbutton
3	1.868	6.500	22.5 mm Miniature Pushbutton

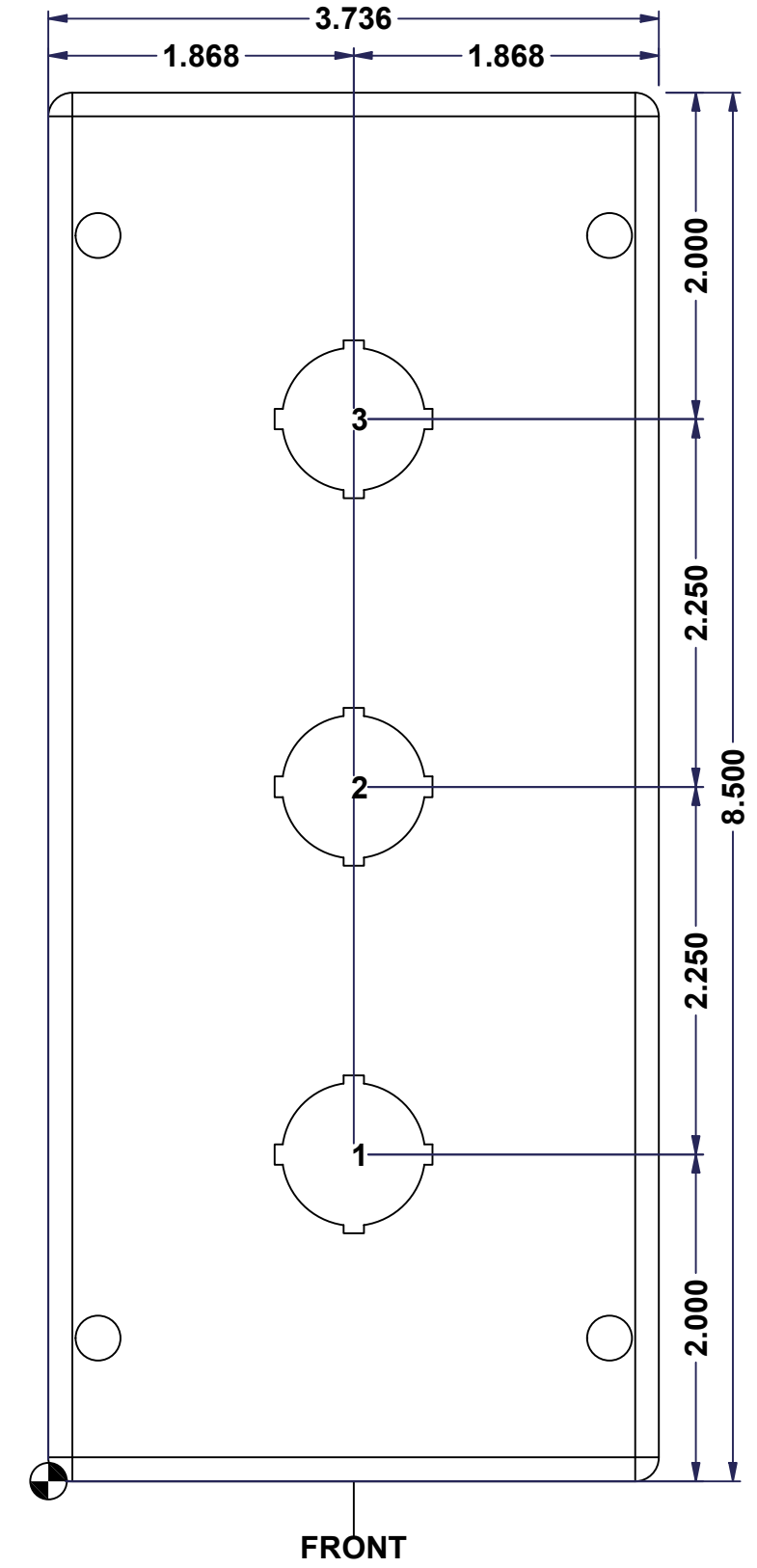



	Description	Status
	1412SDMN 8.5" x 3.5" Cover	(NULL)
Part Number Numéro Pièce 1412SD080302MNC	Rev.	8
	0	9

This drawing is confidential and must not be reproduced or used without the consent of EXM

Ce dessin est confidentiel et ne doit pas être reproduit ou utilisé sans le consentement de EXM

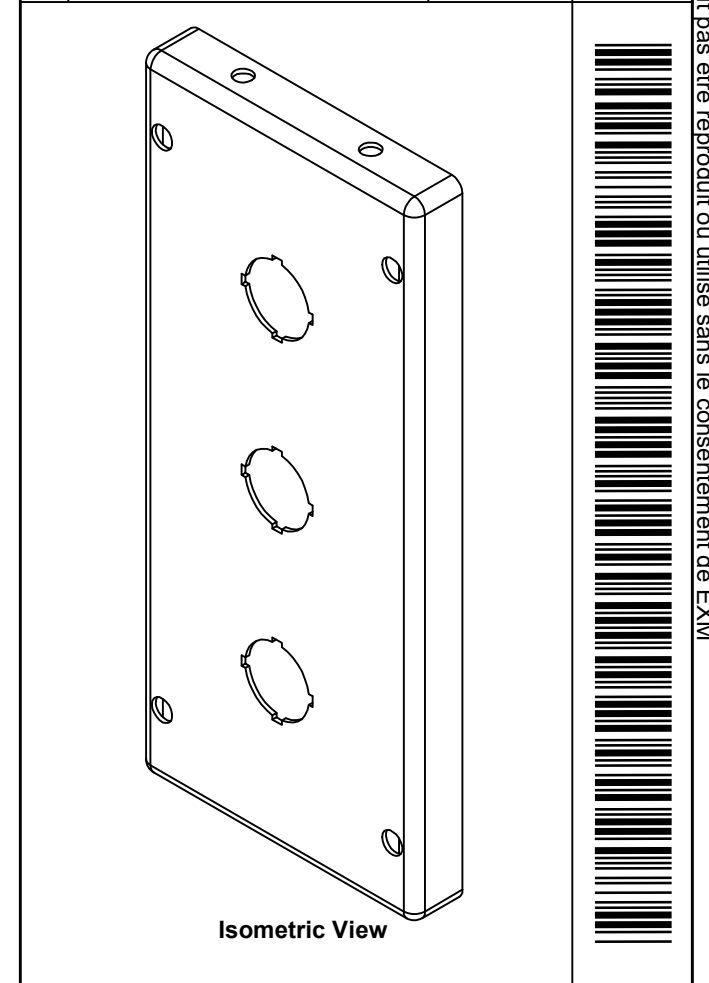
No.	Revisions	Date	By/Par

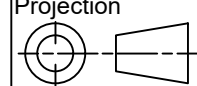

 Tél: (450) 979-4373 Fax: (450) 979-4626 www.exmweb.com		Flatness Aplatissement Max 3.0mm Projection 
Customer Client	Date	
Drawn By Dessiné Par	BoxCad: BoxCad	Date 23-Feb-23
Material Matière	16 Ga Cold Rolled A1008 CS Type B (1.4mm)	
Color Couleur	Asa-61 Grey	Finish Fini Smooth
Description		Detail Rev.
1412SDMN 8.5" x 3.5" Cover		
Part Number Numéro Pièce	Rev.	9
1412SD080302MNC	0	9

Qty	Part Number	Rev	Description
1	STK-P-02400S	0	Powder Paint (Asa-61 Grey / Smooth)
1	1412SD080302MNG	0	1412SD 8.5" x 3.5" Gasket
1	1412SD080302MNC-P	0	1412SDMN 8.5" x 3.5" Cover Part
Parts List			