

This drawing is confidential and must not be reproduced or used without the consent of EXM

Ce dessin est confidentiel et ne doit pas être reproduit ou utilisé sans le consentement de EXM

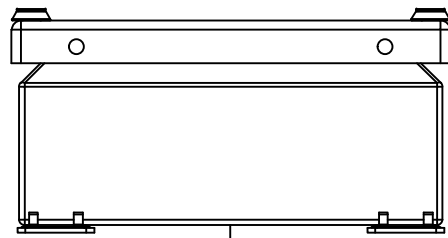

TOP

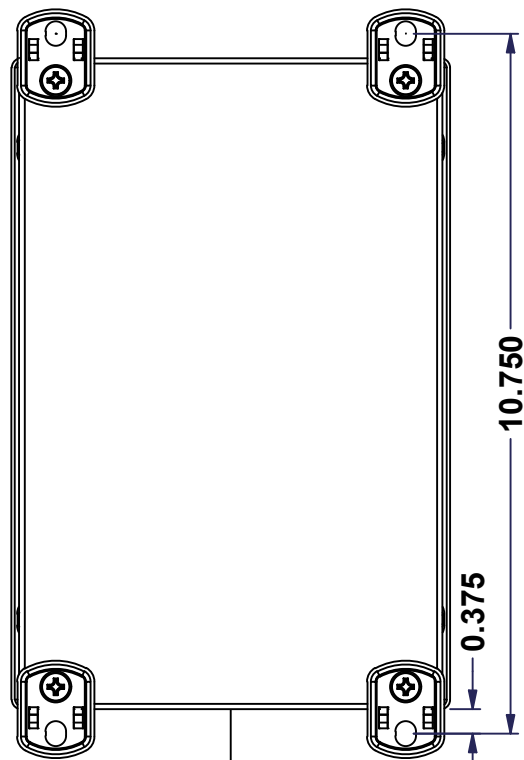

BACK

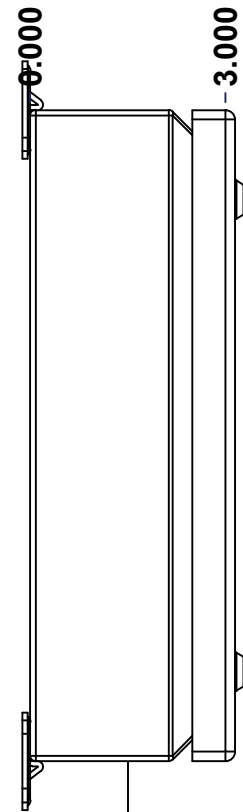

LEFT

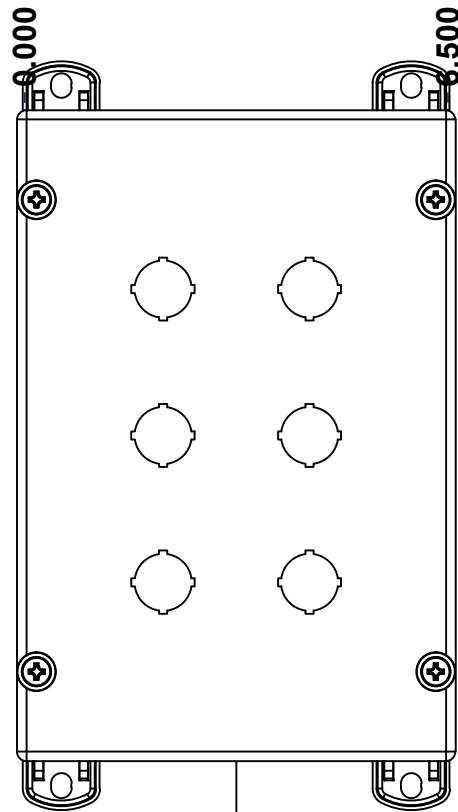

FRONT

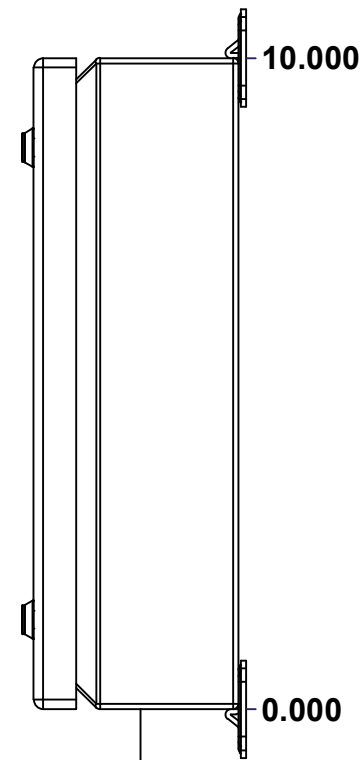

RIGHT

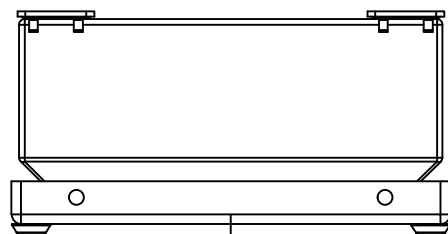

BOTTOM

No.	Revisions	Date	By/Par

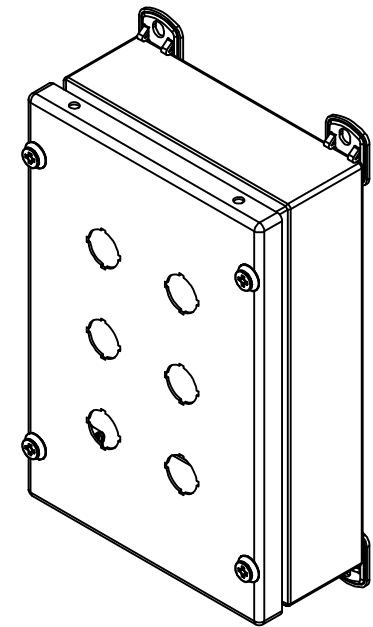

Isometric View



Tél: (450) 979-4373
 Fax: (450) 979-4626
www.exmweb.com

Flatness
Aplatissement

Max 3.0mm

Projection

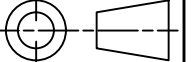

Customer Client	Date
Drawn By Dessiné Par BoxCad: BoxCad	Date 18-Jul-23
Material Matière 16 Ga Cold Rolled A1008 CS Type B (1.4mm)	

Color Couleur Asa-61 Grey	Finish Fini Smooth
------------------------------	-----------------------

Description 1412SDMN 10" x 6.5" x 3" Assembly	Detail Rev.
--	-------------

Part Number Numéro Pièce 1412SD090603MN	Rev. 0	1 9
--	--------	--------

SEE BILL OF MATERIAL ON LAST PAGE

This drawing is confidential and must not be reproduced or used without the consent of EXM

Ce dessin est confidentiel et ne doit pas être reproduit ou utilisé sans le consentement de EXM

NOTE	
ITEM	DESCRIPTION
1	NEMA 4, 12 Enclosure (IP66)
2	C/W Standard ground standoffs on box and cover
3	W/O Standard door stiffener
4	W/O Inner panel
5	W/O Inner panel mounting standoffs
6	C/W 885 ESCHMF1 Mounting Feet (Installed)

No.	Revisions	Date	By/Par

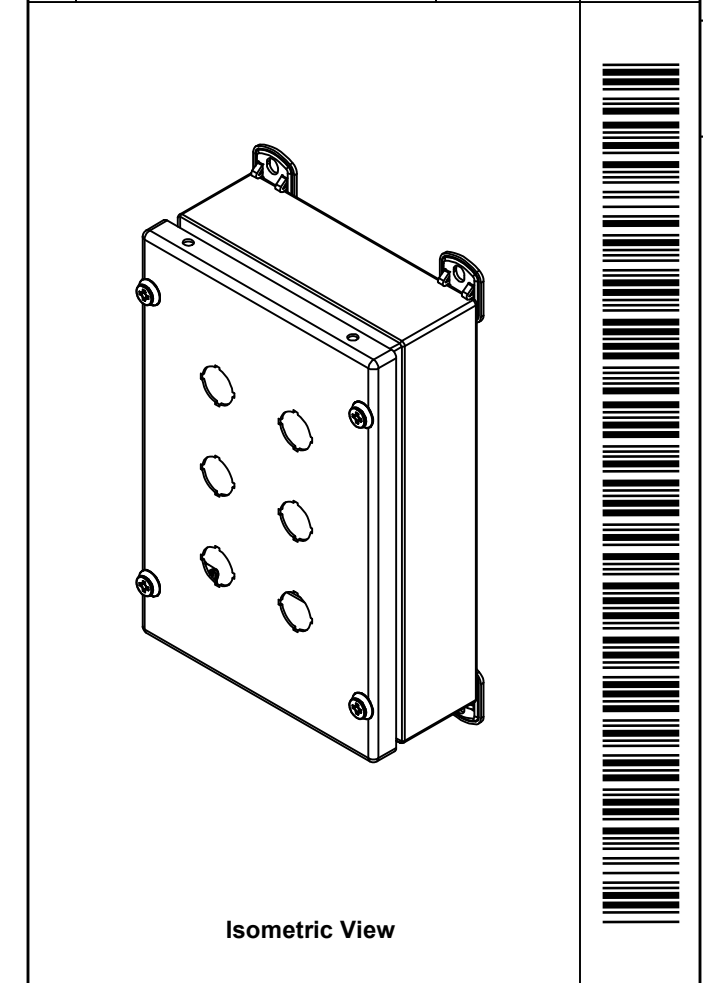

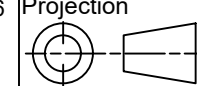
 Tél: (450) 979-4373 Fax: (450) 979-4626 www.exmweb.com	Flatness Aplatissement Max 3.0mm
	Projection 
Customer Client	Date
Drawn By Dessiné Par BoxCad: BoxCad	Date 18-Jul-23
Material Matière 16 Ga Cold Rolled A1008 CS Type B (1.4mm)	
Color Couleur Asa-61 Grey	Finish Fini Smooth

PACKING		
ITEM	QTY	DESCRIPTION
Cardboard sleeve	2	Top and Bottom
Cardboard strip	2	Between back of enclosure and inner panel
Plastic bag	1	To protect cover surface and inside gasket
Plastic strap - Black	2	To Squeeze the 2 cardboard sleeve together
Packaging label	1	White label with product number

Qty	Part Number	Rev	Description
1	STK-K-02920	3	5412 ESSC Accessory Kit
1	1412SD090603MNC	0	1412SDMN 10" x 6.5" Cover
1	1412SD090603MNB	0	1412SDMN 10" x 6.5" x 3" Body
Parts List			

Description 1412SDMN 10" x 6.5" x 3" Assembly		Detail Rev.	
Part Number Numéro Pièce 1412SD090603MN		Rev. 0	2 9

This drawing is confidential and must not be reproduced or used without the consent of EXM

Ce dessin est confidentiel et ne doit pas être reproduit ou utilisé sans le consentement de EXM

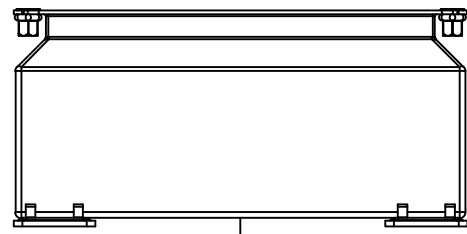

TOP

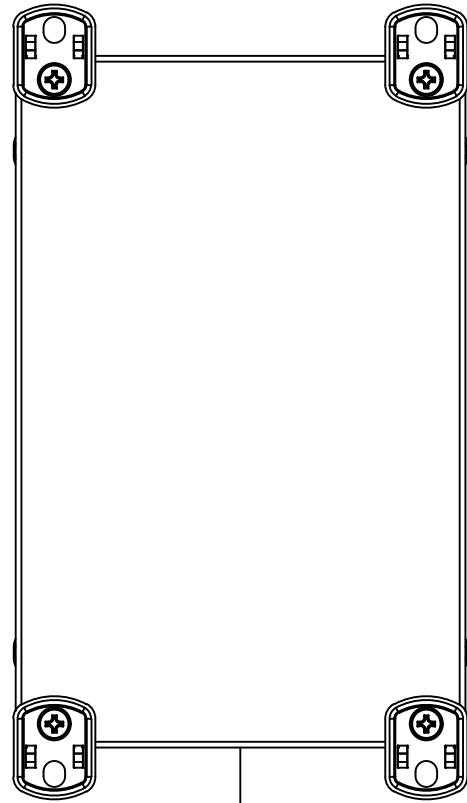

BACK

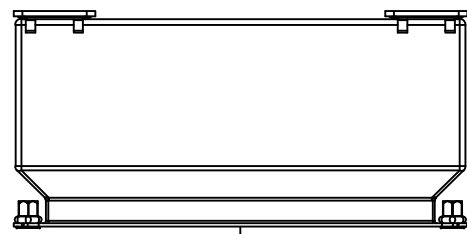

BOTTOM

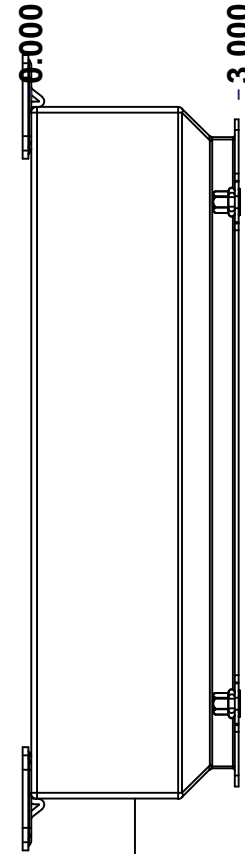

LEFT

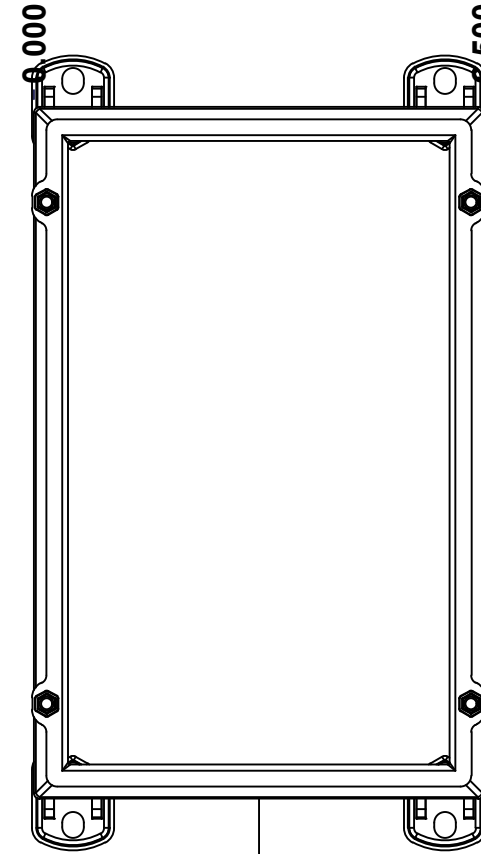

FRONT

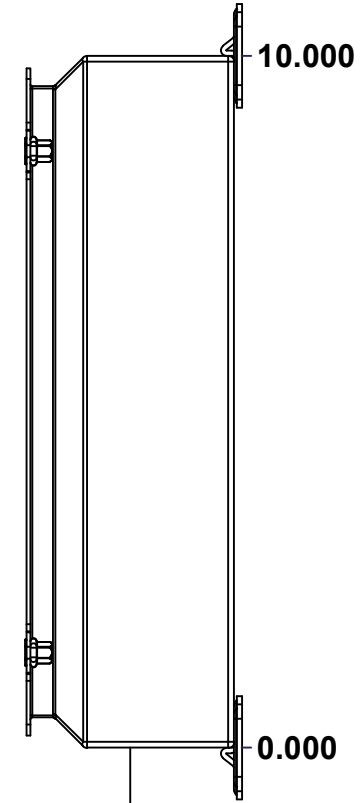

RIGHT

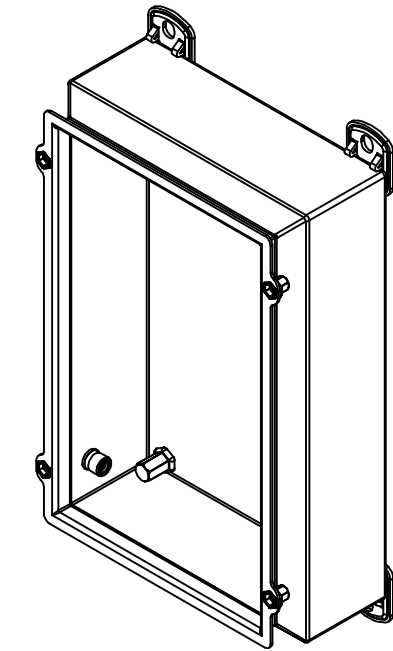

Isometric View

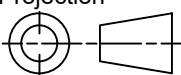

No.	Revisions	Date	By/Par

 Tél: (450) 979-4373 Fax: (450) 979-4626 www.exmweb.com		Flatness Aplatissement Max 3.0mm Projection 
Customer Client	Date	
Drawn By Dessiné Par	BoxCad: BoxCad	Date 18-Jul-23
Material Matière	16 Ga Cold Rolled A1008 CS Type B (1.4mm)	
Color Couleur	Asa-61 Grey	Finish Fini Smooth
Description	Detail Rev.	
1412SDMN 10" x 6.5" x 3" Body		
Part Number Numéro Pièce	Rev.	3
1412SD090603MNB	0	9

SEE BILL OF MATERIAL ON LAST PAGE

This drawing is confidential and must not be reproduced or used without the consent of EXM

Ce dessin est confidentiel et ne doit pas être reproduit ou utilisé sans le consentement de EXM

STANDARD FEATURES ARE NOT LISTED IN THIS HOLE TABLE			
HOLE TABLE - LEFT VIEW (CUSTOM FEATURE ONLY)			
CUT-OUT	XDIM	YDIM	DESCRIPTION
1	1.625	0.875	STANDOFF M6 x 10mm (Inside)

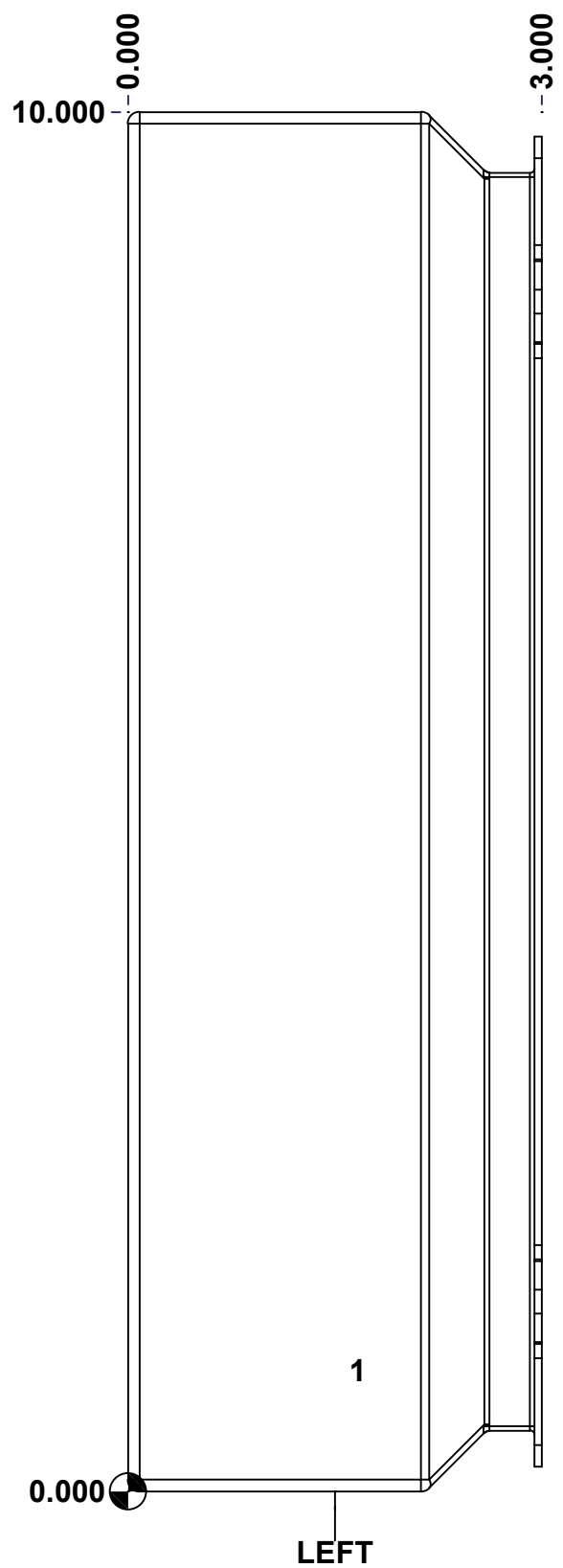

	Description	Status	
	1412SDMN 10" x 6.5" x 3" Body	(NULL)	
	Part Number Numéro Pièce	Rev.	
	1412SD090603MNB	0	4 9

This drawing is confidential and must not be reproduced or used without the consent of EXM

Ce dessin est confidentiel et ne doit pas être reproduit ou utilisé sans le consentement de EXM

STANDARD FEATURES ARE NOT LISTED IN THIS HOLE TABLE

HOLE TABLE - BACK VIEW (CUSTOM FEATURE ONLY)

CUT-OUT	XDIM	YDIM	DESCRIPTION
1	5.937	0.000	FOOT 885 ESCHMF1
2	0.563	0.000	FOOT 885 ESCHMF1
3	5.937	10.000	FOOT 885 ESCHMF1
4	0.563	10.000	FOOT 885 ESCHMF1
5	5.937	0.344	RIVET NUT M6_FH_CE (Inside)
6	0.563	0.344	RIVET NUT M6_FH_CE (Inside)
7	5.937	9.656	RIVET NUT M6_FH_CE (Inside)
8	0.563	9.656	RIVET NUT M6_FH_CE (Inside)

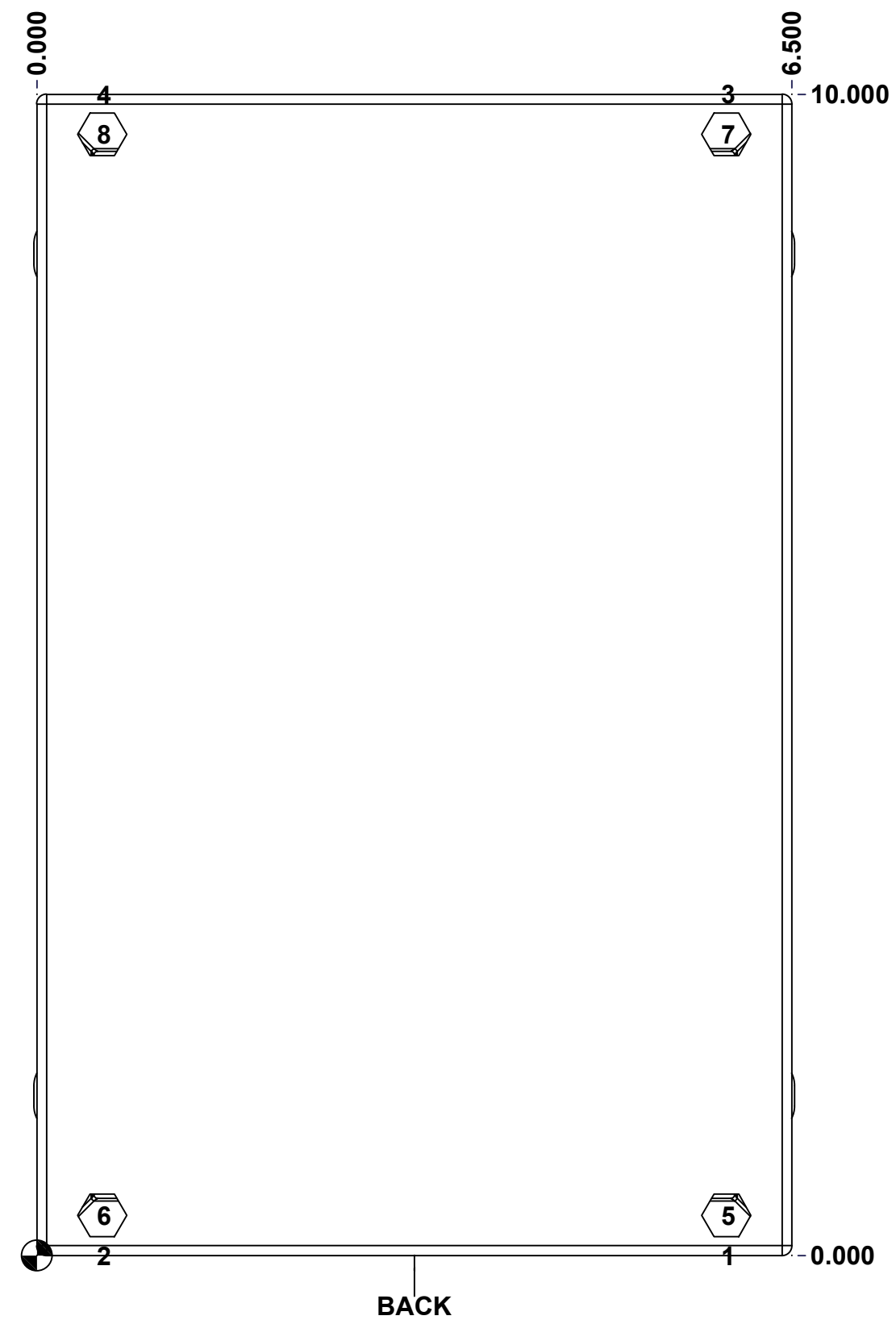

	Description	Status
	1412SDMN 10" x 6.5" x 3" Body	(NULL)
	Part Number Numéro Pièce	Rev.
	1412SD090603MNB	0 / 5 9

This drawing is confidential and must not be reproduced or used without the consent of EXM

Ce dessin est confidentiel et ne doit pas être reproduit ou utilisé sans le consentement de EXM

No.	Revisions	Date	By/Par

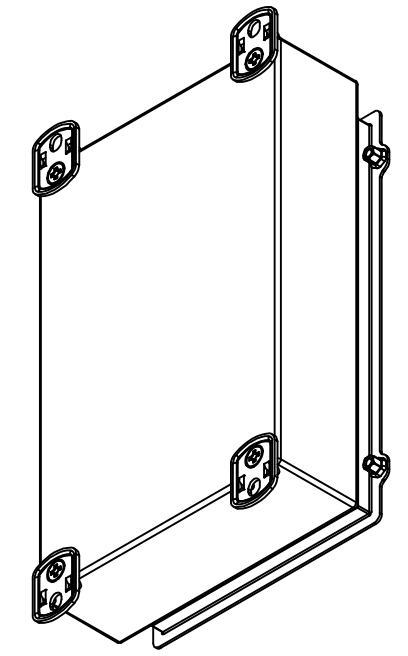

Isometric View



 Tél: (450) 979-4373
 Fax: (450) 979-4626
www.exmweb.com

Flatness / Aplatissement: Max 3.0mm
 Projection: 

Customer / Client	Date
Drawn By / Dessiné Par: BoxCad: BoxCad	Date: 18-Jul-23
Material / Matière: 16 Ga Cold Rolled A1008 CS Type B (1.4mm)	

Color / Couleur: Asa-61 Grey	Finish / Fini: Smooth
------------------------------	-----------------------

Description: 1412SDMN 10" x 6.5" x 3" Body	Detail Rev.
--	-------------

Part Number / Numéro Pièce: 1412SD090603MNB	Rev. 0	6 / 9
--	--------	-------

Qty	Part Number	Rev	Description
4	STK-Q-03071	0	M6 x 16mm Machine Screw
4	RIVET_NUT_M6_FH_CE	0	Rivet Nut M6 (Low Profile Close End)
4	885 ESCHMF1	2	5412 ESCH Stamped Mounting Foot
1	STK-P-02400S	0	Powder Paint (Asa-61 Grey / Smooth)
1	1412SD090603MNB-P	0	1412SDMN 10" x 6.5" x 3" Body Part
1	STK-Q-08350	5	Standoff M6 x 10mm
4	RIVET_NUT_M5_FH_OE	0	Rivet Nut M5 (Low Profile Open End)
Parts List			

This drawing is confidential and must not be reproduced or used without the consent of EXM

Ce dessin est confidentiel et ne doit pas être reproduit ou utilisé sans le consentement de EXM

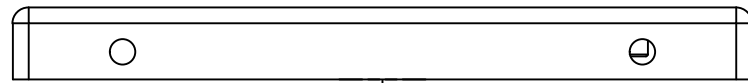

TOP

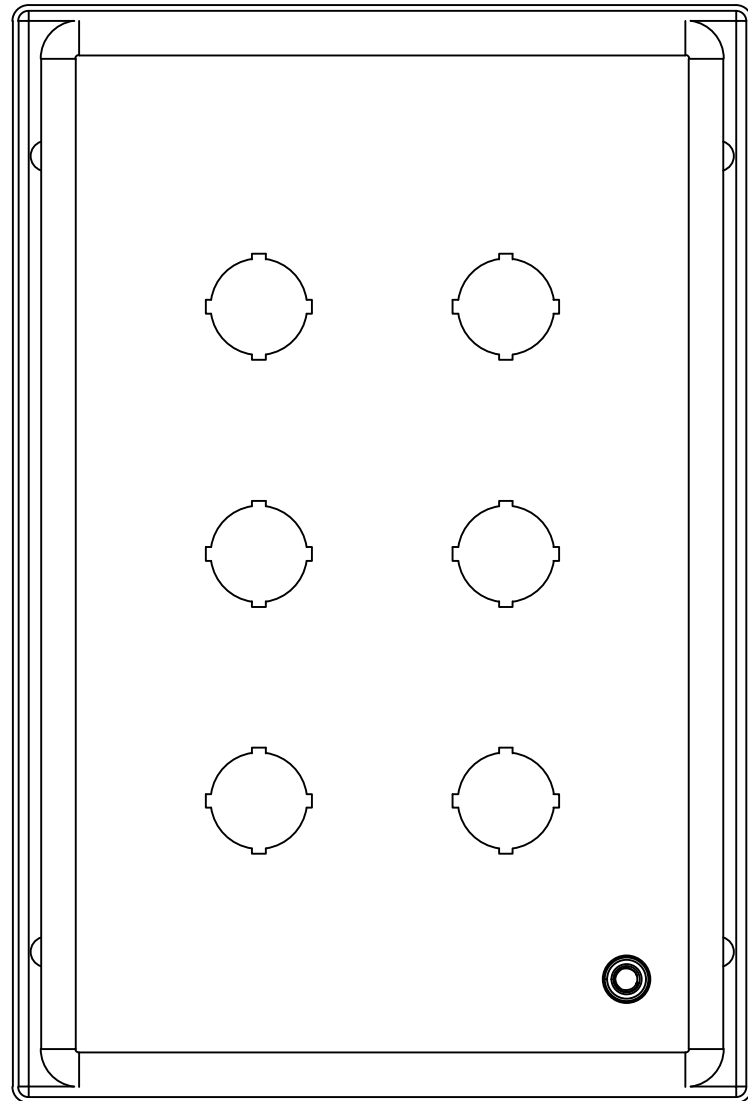

BACK

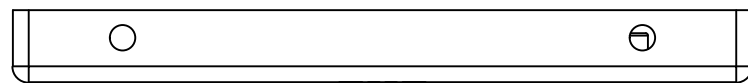

BOTTOM

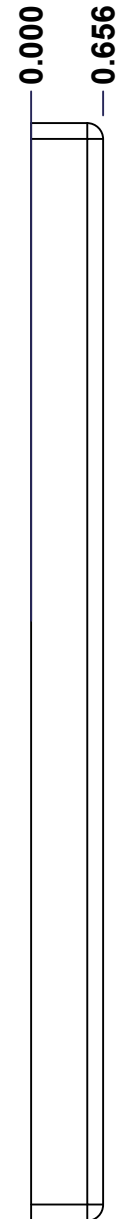

LEFT

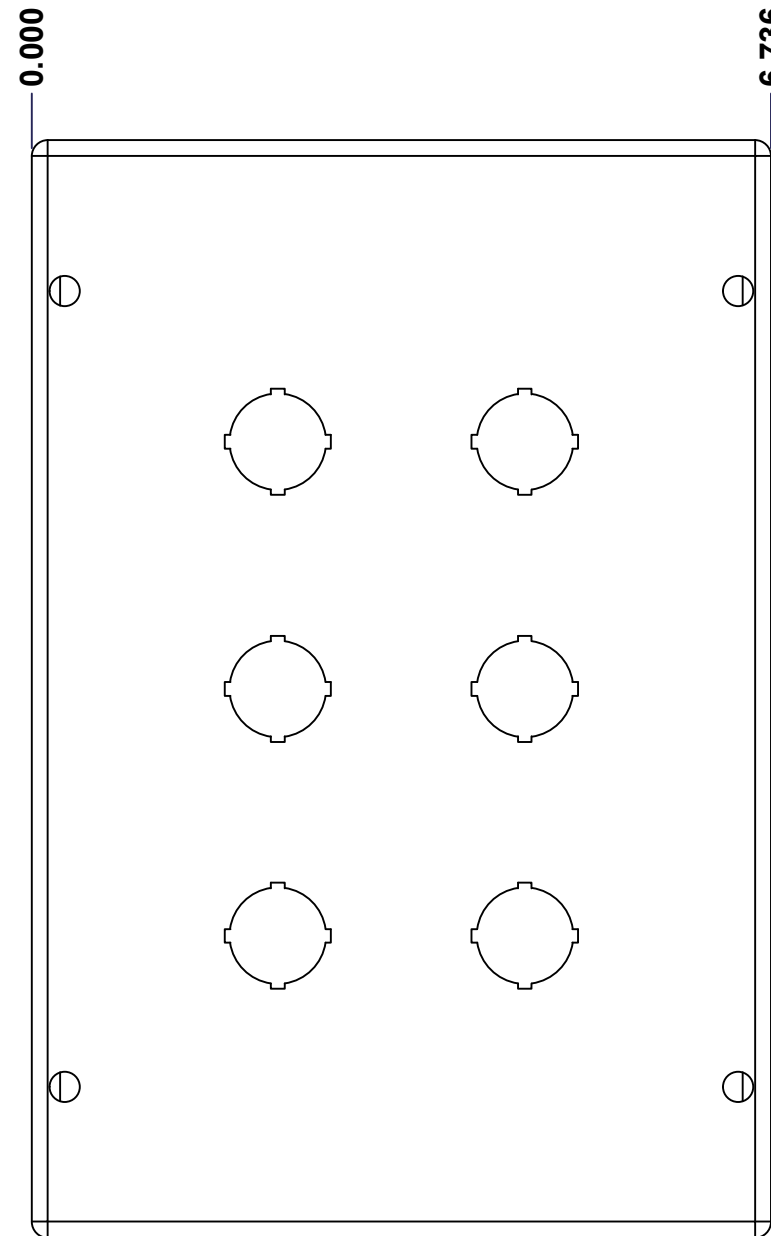

FRONT

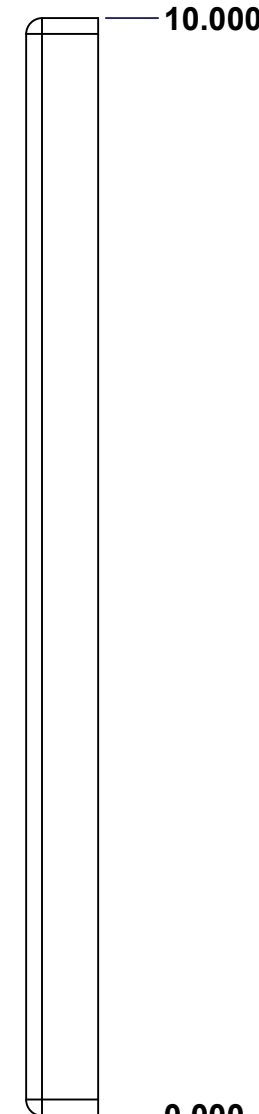

RIGHT

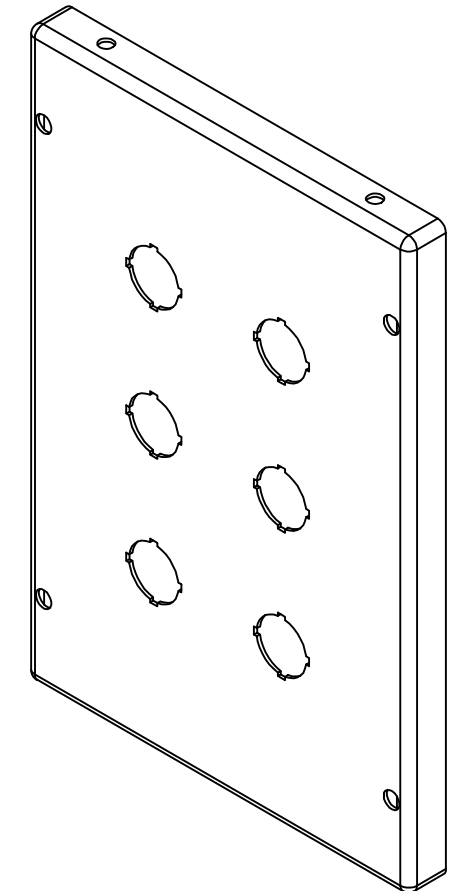

Isometric View

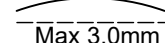
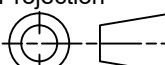

No.	Revisions	Date	By/Par

 Tél: (450) 979-4373 Fax: (450) 979-4626 www.exmweb.com		Flatness Aplatissement  Max 3.0mm Projection 
Customer Client	Date	
Drawn By Dessiné Par	BoxCad: BoxCad	Date 18-Jul-23
Material Matière	16 Ga Cold Rolled A1008 CS Type B (1.4mm)	
Color Couleur	Asa-61 Grey	Finish Fini Smooth
Description 1412SDMN 10" x 6.5" Cover		Detail Rev.
Part Number Numéro Pièce	1412SD090603MNC	Rev. 7 0 9

SEE BILL OF MATERIAL ON LAST PAGE

This drawing is confidential and must not be reproduced or used without the consent of EXM

Ce dessin est confidentiel et ne doit pas être reproduit ou utilisé sans le consentement de EXM

STANDARD FEATURES ARE NOT LISTED IN THIS HOLE TABLE			
HOLE TABLE - FRONT VIEW (CUSTOM FEATURE ONLY)			
CUT-OUT	XDIM	YDIM	DESCRIPTION
1	4.493	2.750	22.5 mm Miniature Pushbutton
2	4.493	5.000	22.5 mm Miniature Pushbutton
3	4.493	7.250	22.5 mm Miniature Pushbutton
4	2.243	2.750	22.5 mm Miniature Pushbutton
5	2.243	5.000	22.5 mm Miniature Pushbutton
6	2.243	7.250	22.5 mm Miniature Pushbutton
7	1.145	1.125	STANDOFF M6 x 10mm (Inside)

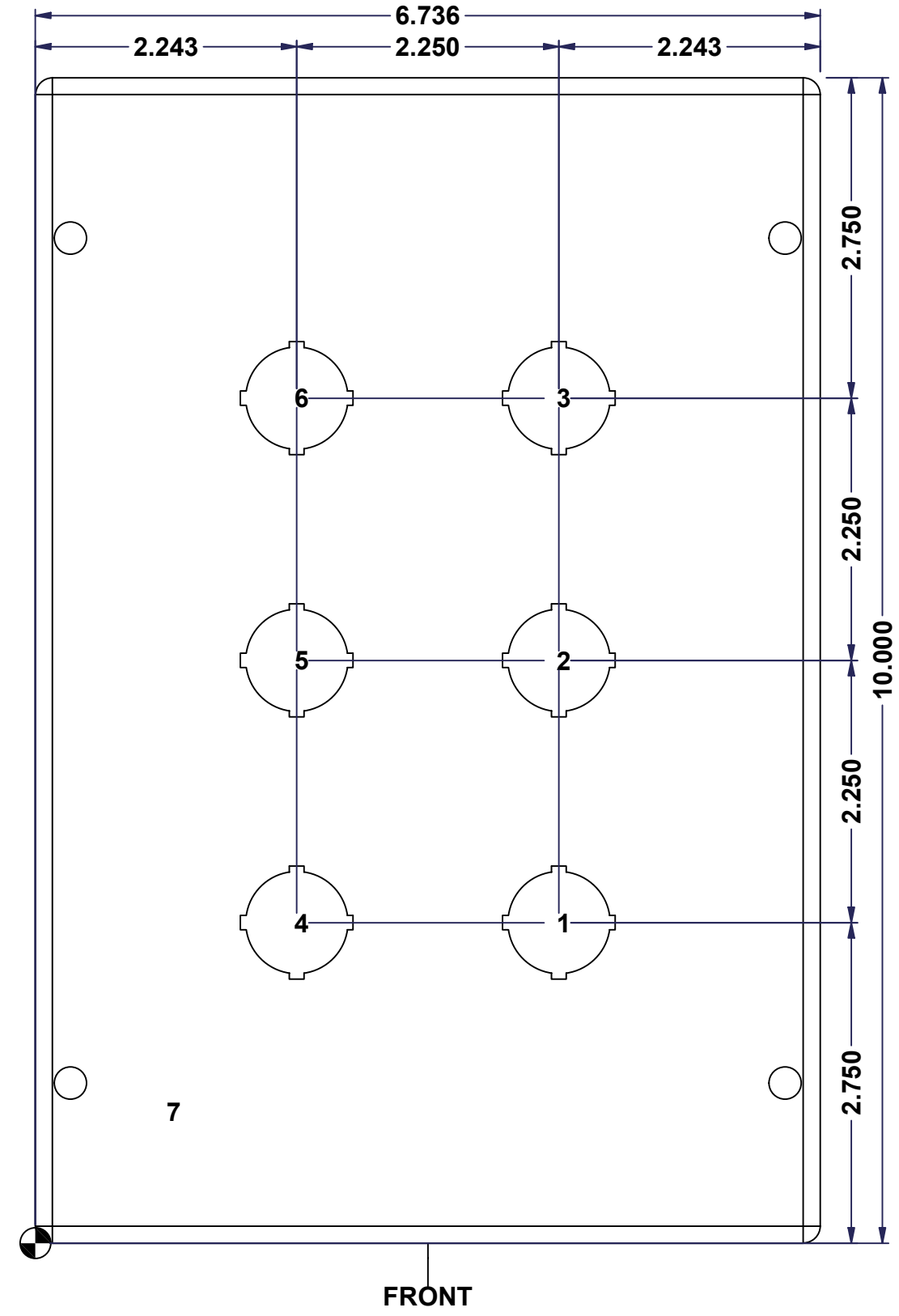

FRONT

	Description	Status
	1412SDMN 10" x 6.5" Cover	(NULL)
Part Number Numéro Pièce 1412SD090603MNC	Rev.	8
	0	9

This drawing is confidential and must not be reproduced or used without the consent of EXM

Ce dessin est confidentiel et ne doit pas être reproduit ou utilisé sans le consentement de EXM

No.	Revisions	Date	By/Par

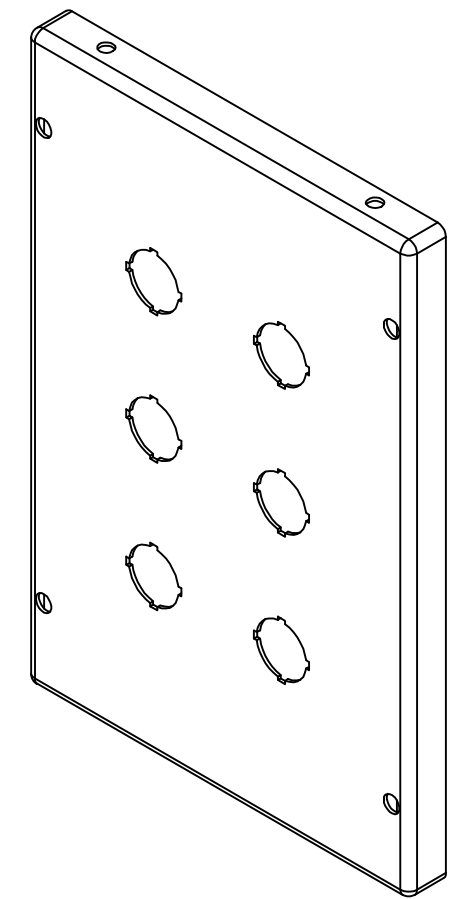

Isometric View

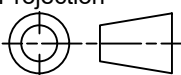

 Tél: (450) 979-4373 Fax: (450) 979-4626 www.exmweb.com	Flatness Aplatissement	Max 3.0mm
	Projection	
Customer Client	Date	
Drawn By Dessiné Par	BoxCad: BoxCad	Date 18-Jul-23
Material Matière	16 Ga Cold Rolled A1008 CS Type B (1.4mm)	
Color Couleur	Asa-61 Grey	Finish Fini Smooth
Description	Detail Rev.	
1412SDMN 10" x 6.5" Cover		
Part Number Numéro Pièce	Rev.	9
1412SD090603MNC	0	9

Qty	Part Number	Rev	Description
1	STK-Q-08350	5	Standoff M6 x 10mm
1	STK-P-02400S	0	Powder Paint (Asa-61 Grey / Smooth)
1	1412SD090603MNG	0	1412SD 10" x 6.5" Gasket
1	1412SD090603MNC-P	0	1412SDMN 10" x 6.5" Cover Part
Parts List			