

This drawing is confidential and must not be reproduced or used without the consent of EXM

Ce dessin est confidentiel et ne doit pas être reproduit ou utilisé sans le consentement de EXM

| No. | Revisions | Date | By/Par |
|-----|-----------|------|--------|
| | | | |
| | | | |
| | | | |
| | | | |
| | | | |

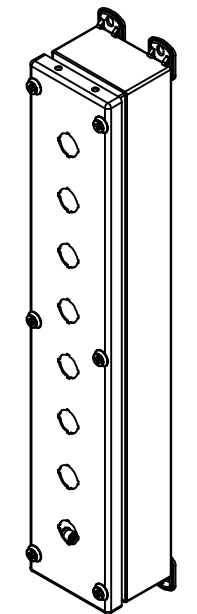
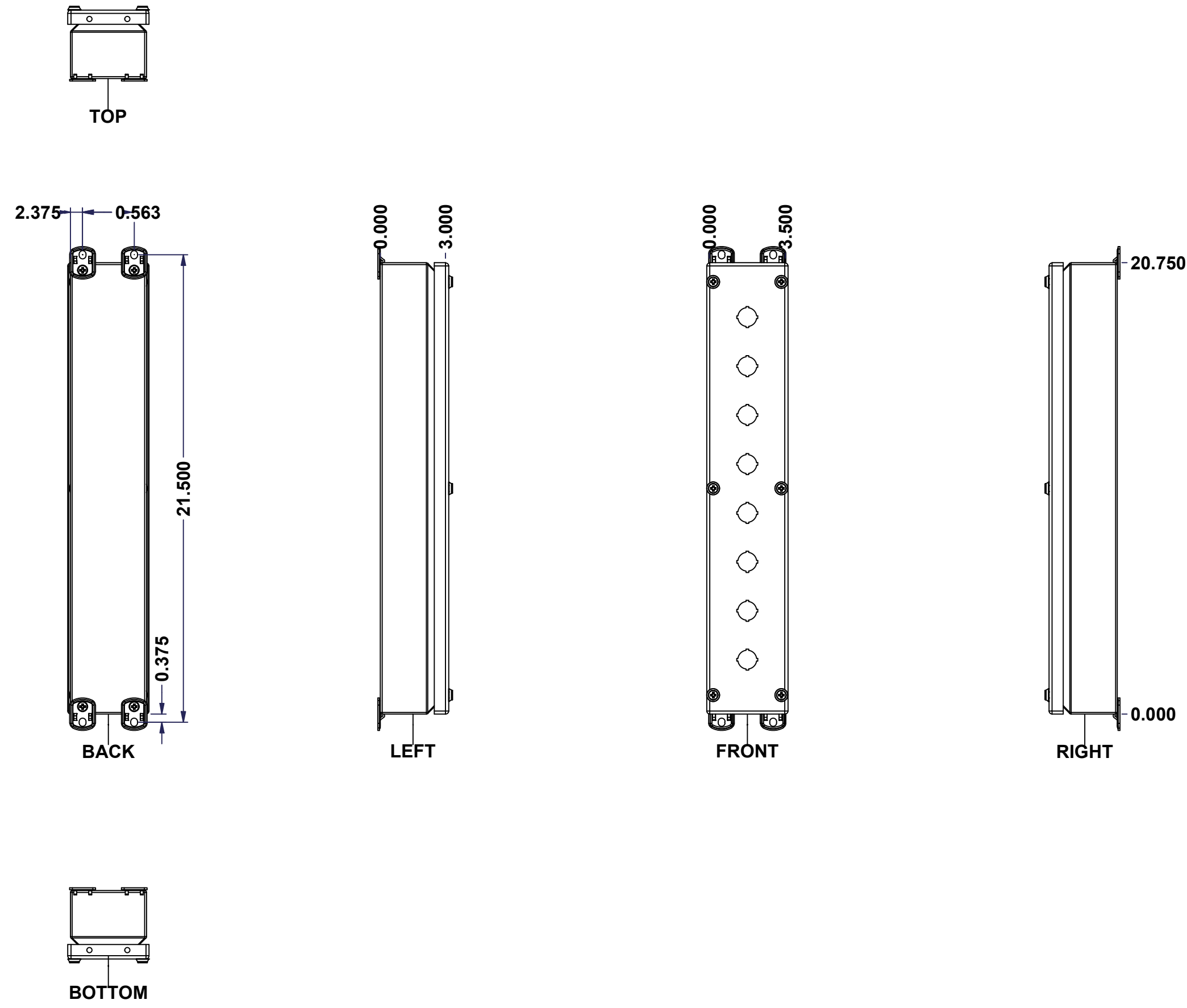

Isometric View



| | | |
|--|---|--|
| Tél: (450) 979-4373 Fax: (450) 979-4626 www.exmweb.com | | Flatness Aplatissement Max 3.0mm Projection |
| Customer Client | Date | |
| Drawn By Dessiné Par | BoxCad: BoxCad | Date 24-May-23 |
| Material Matière | 16 Ga Cold Rolled A1008 CS Type B (1.4mm) | |
| Color Couleur | Asa-61 Grey | Finish Fini Smooth |
| Description | Detail Rev. | |
| 1412SDMN 20.75" x 3.5" x 3" Assembly | | |
| Part Number Numéro Pièce | Rev. 0 | 1/9 |
| 1412SD200302MN | | |

SEE BILL OF MATERIAL ON LAST PAGE

This drawing is confidential and must not be reproduced or used without the consent of EXM

Ce dessin est confidentiel et ne doit pas être reproduit ou utilisé sans le consentement de EXM

| NOTE | |
|------|---|
| ITEM | DESCRIPTION |
| 1 | NEMA 4, 12 Enclosure (IP66) |
| 2 | C/W Standard ground standoffs on box only |
| 3 | W/O Standard door stiffener |
| 4 | W/O Inner panel |
| 5 | W/O Inner panel mounting standoffs |
| 6 | C/W 885 ESCHMF1 Mounting Feet (Installed) |

| No. | Revisions | Date | By/Par |
|-----|-----------|------|--------|
| | | | |
| | | | |
| | | | |
| | | | |
| | | | |
| | | | |

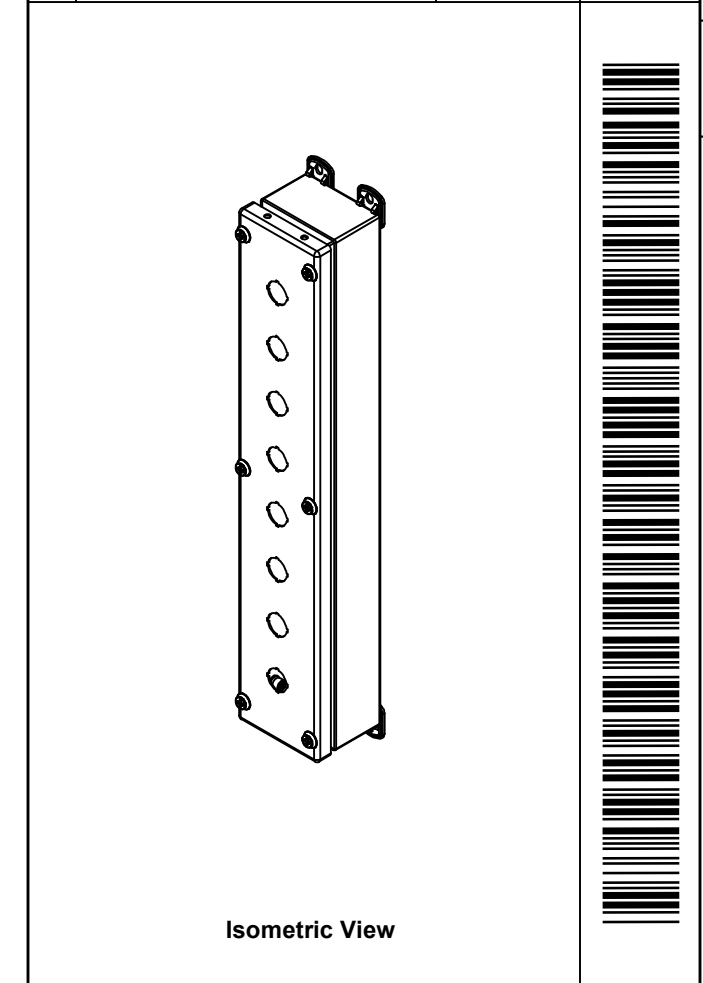

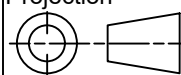
| | |
|--|---|
|  Tél: (450) 979-4373 Fax: (450) 979-4626 www.exmweb.com | Flatness Aplatissement Max 3.0mm |
| | Projection  |
| Customer Client | Date |
| Drawn By Dessiné Par BoxCad: BoxCad | Date 24-May-23 |
| Material Matière 16 Ga Cold Rolled A1008 CS Type B (1.4mm) | |
| Color Couleur Asa-61 Grey | Finish Fini Smooth |
| Description 1412SDMN 20.75" x 3.5" x 3" Assembly | Detail Rev. |
| Part Number Numéro Pièce 1412SD200302MN | Rev. 2 0 9 |

| PACKING | | |
|-----------------------|-----|--|
| ITEM | QTY | DESCRIPTION |
| Cardboard sleeve | 2 | Top and Bottom |
| Cardboard strip | 2 | Between back of enclosure and inner panel |
| Plastic bag | 1 | To protect cover surface and inside gasket |
| Plastic strap - Black | 2 | To Squeeze the 2 cardboard sleeve together |
| Packaging label | 1 | White label with product number |

| Qty | Part Number | Rev | Description |
|------------|-----------------|-----|----------------------------------|
| 1 | STK-K-02920 | 3 | 5412 ESSC Accessory Kit |
| 1 | 1412SD200302MNC | 0 | 1412SDMN 20.75" x 3.5" Cover |
| 1 | 1412SD200302MNB | 0 | 1412SDMN 20.75" x 3.5" x 3" Body |
| Parts List | | | |

This drawing is confidential and must not be reproduced or used without the consent of EXM

Ce dessin est confidentiel et ne doit pas être reproduit ou utilisé sans le consentement de EXM

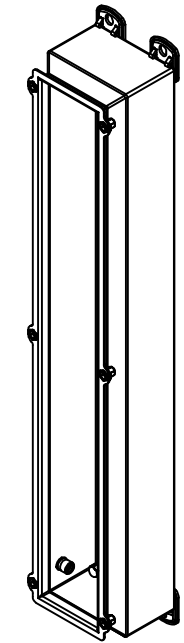
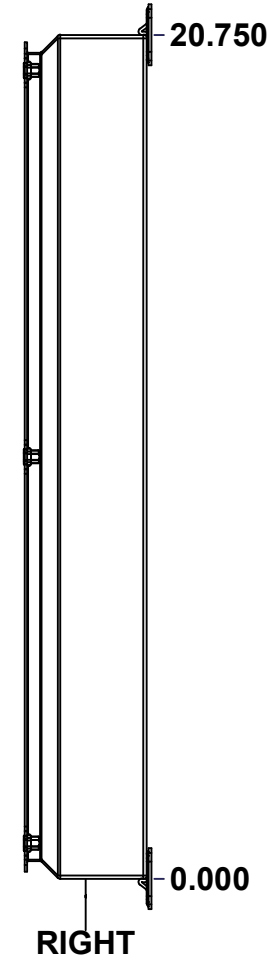
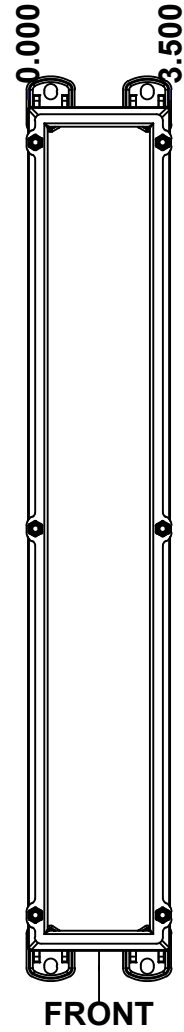
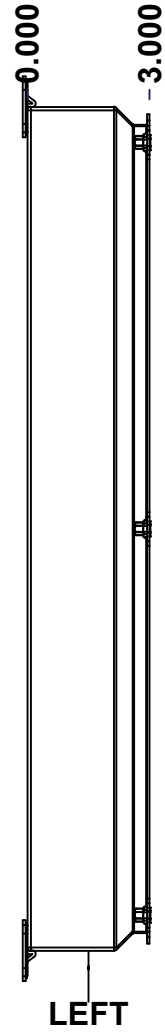
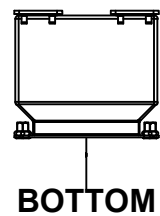
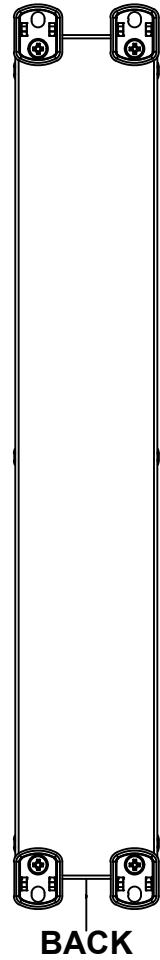
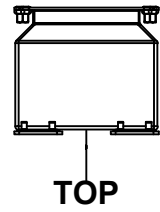

| No. | Revisions | Date | By/Par |
|-----|-----------|------|--------|
| | | | |
| | | | |
| | | | |
| | | | |
| | | | |

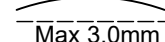
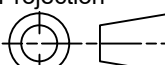
| | | |
|--|---|---|
|  Tél: (450) 979-4373 Fax: (450) 979-4626 www.exmweb.com | | Flatness Aplatissement  Max 3.0mm Projection  |
| Customer Client | Date | |
| Drawn By Dessiné Par | BoxCad: BoxCad | Date 24-May-23 |
| Material Matière | 16 Ga Cold Rolled A1008 CS Type B (1.4mm) | |
| Color Couleur | Asa-61 Grey | Finish Fini Smooth |
| Description | Detail Rev. | |
| 1412SDMN 20.75" x 3.5" x 3" Body | | |
| Part Number Numéro Pièce | Rev. | 3 |
| 1412SD200302MNB | 0 | 9 |

SEE BILL OF MATERIAL ON LAST PAGE

This drawing is confidential and must not be reproduced or used without the consent of EXM

Ce dessin est confidentiel et ne doit pas être reproduit ou utilisé sans le consentement de EXM

| STANDARD FEATURES ARE NOT LISTED IN THIS HOLE TABLE | | | |
|--|-------|-------|-----------------------------|
| HOLE TABLE - LEFT VIEW (CUSTOM FEATURE ONLY) | | | |
| CUT-OUT | XDIM | YDIM | DESCRIPTION |
| 1 | 1.625 | 0.875 | STANDOFF M6 x 10mm (Inside) |

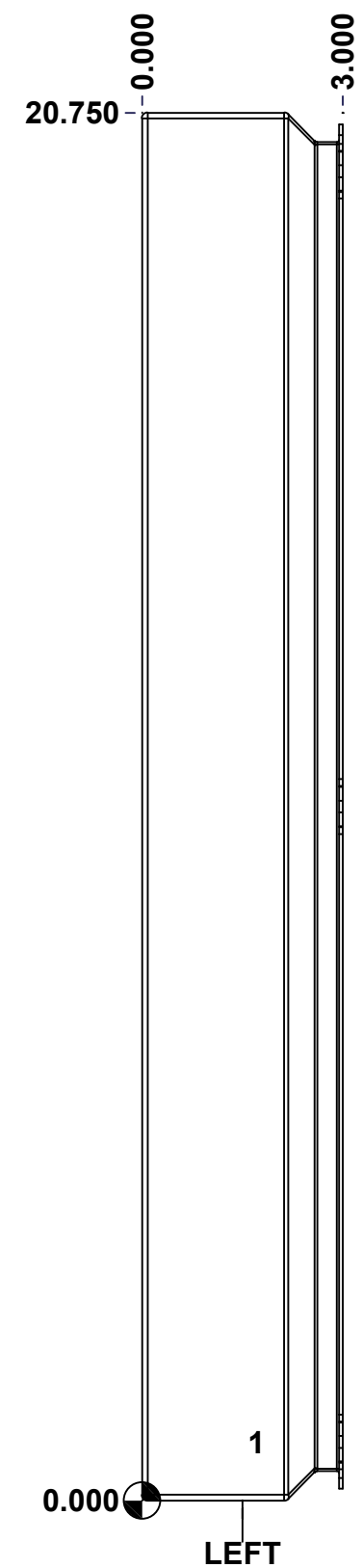

| | | | |
|--|----------------------------------|----------|--------|
| | Description | Status | |
| | 1412SDMN 20.75" x 3.5" x 3" Body | (NULL) | |
| | Part Number Numéro Pièce | Rev. | |
| | 1412SD200302MNB | 0 | 4 9 |

This drawing is confidential and must not be reproduced or used without the consent of EXM

Ce dessin est confidentiel et ne doit pas être reproduit ou utilisé sans le consentement de EXM

STANDARD FEATURES ARE NOT LISTED IN THIS HOLE TABLE

HOLE TABLE - BACK VIEW (CUSTOM FEATURE ONLY)

| CUT-OUT | XDIM | YDIM | DESCRIPTION |
|---------|-------|--------|-----------------------------|
| 1 | 2.937 | 0.000 | FOOT 885 ESCHMF1 |
| 2 | 0.563 | 0.000 | FOOT 885 ESCHMF1 |
| 3 | 2.937 | 20.750 | FOOT 885 ESCHMF1 |
| 4 | 0.563 | 20.750 | FOOT 885 ESCHMF1 |
| 5 | 2.937 | 0.344 | RIVET NUT M6_FH_CE (Inside) |
| 6 | 0.563 | 0.344 | RIVET NUT M6_FH_CE (Inside) |
| 7 | 2.937 | 20.406 | RIVET NUT M6_FH_CE (Inside) |
| 8 | 0.563 | 20.406 | RIVET NUT M6_FH_CE (Inside) |

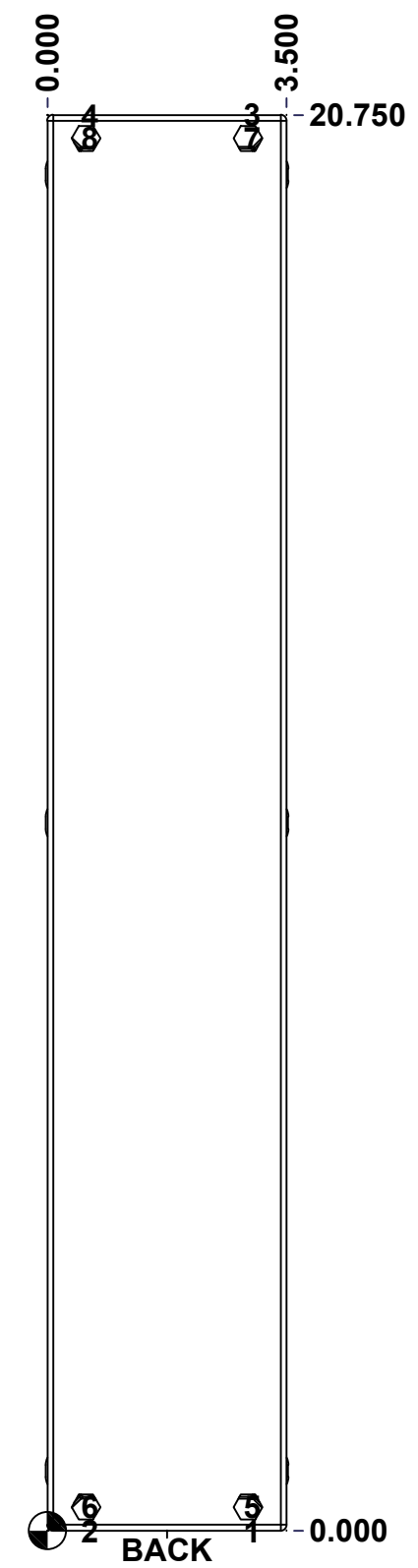

| | | | |
|--|----------------------------------|----------|--------|
| | Description | Status | |
| | 1412SDMN 20.75" x 3.5" x 3" Body | (NULL) | |
| | Part Number Numéro Pièce | Rev. | |
| | 1412SD200302MNB | 0 | 5 9 |

This drawing is confidential and must not be reproduced or used without the consent of EXM

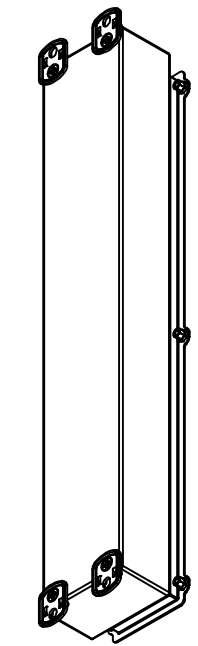

Ce dessin est confidentiel et ne doit pas être reproduit ou utilisé sans le consentement de EXM

| No. | Revisions | Date | By/Par |
|-----|-----------|------|--------|
| | | | |
| | | | |
| | | | |
| | | | |
| | | | |



Isometric View

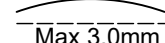

| | | |
|--|---|---|
|  Tél: (450) 979-4373 Fax: (450) 979-4626 www.exmweb.com | | Flatness Aplatissement  Max 3.0mm Projection  |
| Customer Client | Date | |
| Drawn By Dessiné Par | BoxCad: BoxCad | Date 24-May-23 |
| Material Matière | 16 Ga Cold Rolled A1008 CS Type B (1.4mm) | |
| Color Couleur | Asa-61 Grey | Finish Fini Smooth |
| Description | | Detail Rev. |
| 1412SDMN 20.75" x 3.5" x 3" Body | | |
| Part Number Numéro Pièce | Rev. | 6 |
| 1412SD200302MNB | 0 | 9 |

| Qty | Part Number | Rev | Description |
|------------|--------------------|-----|---------------------------------------|
| 4 | STK-Q-03071 | 0 | M6 x 16mm Machine Screw |
| 4 | RIVET_NUT_M6_FH_CE | 0 | Rivet Nut M6 (Low Profile Close End) |
| 4 | 885 ESCHMF1 | 2 | 5412 ESCH Stamped Mounting Foot |
| 1 | STK-P-02400S | 0 | Powder Paint (Asa-61 Grey / Smooth) |
| 1 | 1412SD200302MNB-P | 0 | 1412SDMN 20.75" x 3.5" x 3" Body Part |
| 1 | STK-Q-08350 | 5 | Standoff M6 x 10mm |
| 6 | RIVET_NUT_M5_FH_OE | 0 | Rivet Nut M5 (Low Profile Open End) |
| Parts List | | | |

This drawing is confidential and must not be reproduced or used without the consent of EXM

Ce dessin est confidentiel et ne doit pas être reproduit ou utilisé sans le consentement de EXM

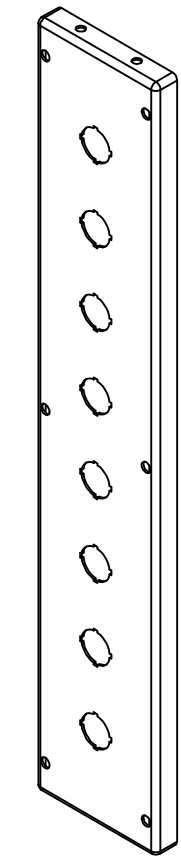
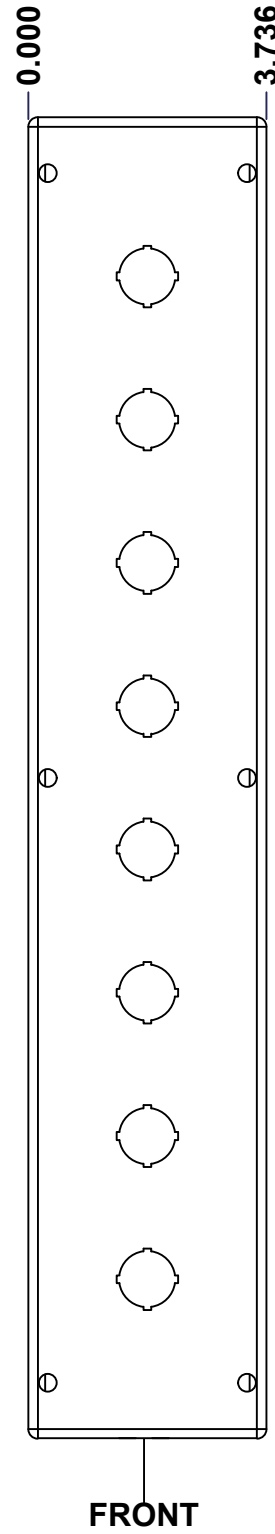
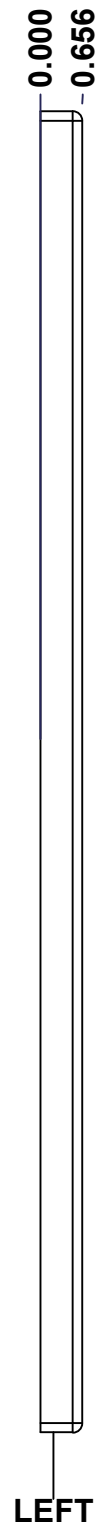
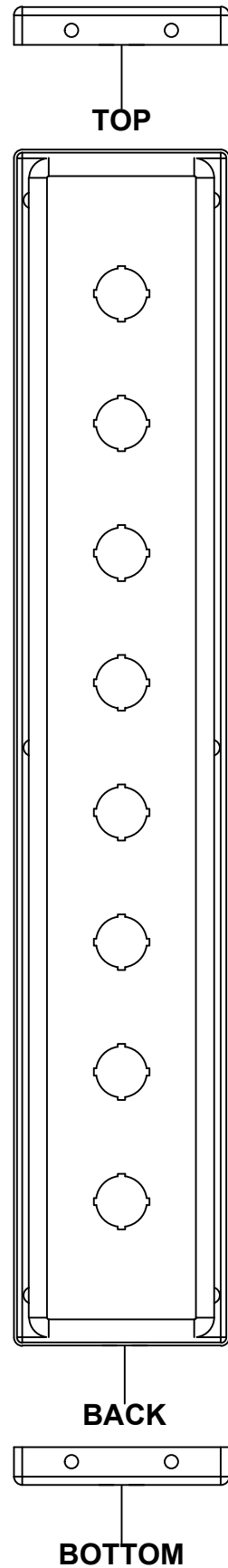

Isometric View

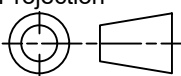

| No. | Revisions | Date | By/Par |
|-----|-----------|------|--------|
| | | | |
| | | | |
| | | | |
| | | | |
| | | | |

| | | |
|--|-----------------------|---|
|  Tél: (450) 979-4373 Fax: (450) 979-4626 www.exmweb.com | | Flatness Aplatissement Max 3.0mm Projection  |
| Customer Client | Date | |
| Drawn By / Dessiné Par: BoxCad: BoxCad | Date: 24-May-23 | |
| Material / Matière: 16 Ga Cold Rolled A1008 CS Type B (1.4mm) | | |
| Color / Couleur: Asa-61 Grey | Finish / Fini: Smooth | |
| Description: 1412SDMN 20.75" x 3.5" Cover | | Detail Rev. |
| Part Number / Numéro Pièce: 1412SD200302MNC | Rev. 0 | 7/9 |

SEE BILL OF MATERIAL ON LAST PAGE

This drawing is confidential and must not be reproduced or used without the consent of EXM

Ce dessin est confidentiel et ne doit pas être reproduit ou utilisé sans le consentement de EXM

STANDARD FEATURES ARE NOT LISTED IN THIS HOLE TABLE

HOLE TABLE - FRONT VIEW (CUSTOM FEATURE ONLY)

| CUT-OUT | XDIM | YDIM | DESCRIPTION |
|---------|-------|--------|------------------------------|
| 1 | 1.868 | 2.500 | 22.5 mm Miniature Pushbutton |
| 2 | 1.868 | 4.750 | 22.5 mm Miniature Pushbutton |
| 3 | 1.868 | 7.000 | 22.5 mm Miniature Pushbutton |
| 4 | 1.868 | 9.250 | 22.5 mm Miniature Pushbutton |
| 5 | 1.868 | 11.500 | 22.5 mm Miniature Pushbutton |
| 6 | 1.868 | 13.750 | 22.5 mm Miniature Pushbutton |
| 7 | 1.868 | 16.000 | 22.5 mm Miniature Pushbutton |
| 8 | 1.868 | 18.250 | 22.5 mm Miniature Pushbutton |

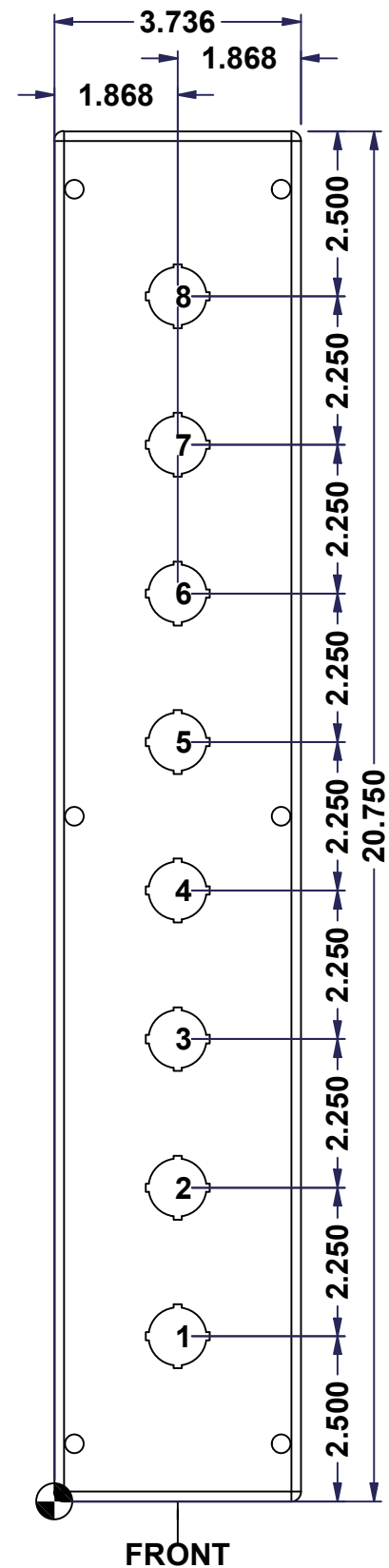

| | | |
|--|------------------------------|-------------------|
| | Description | Status |
| | 1412SDMN 20.75" x 3.5" Cover | (NULL) |
| | Part Number Numéro Pièce | Rev. |
| | 1412SD200302MNC | 0 / 8 9 |

This drawing is confidential and must not be reproduced or used without the consent of EXM

Ce dessin est confidentiel et ne doit pas être reproduit ou utilisé sans le consentement de EXM

| No. | Revisions | Date | By/Par |
|-----|-----------|------|--------|
| | | | |
| | | | |
| | | | |
| | | | |
| | | | |

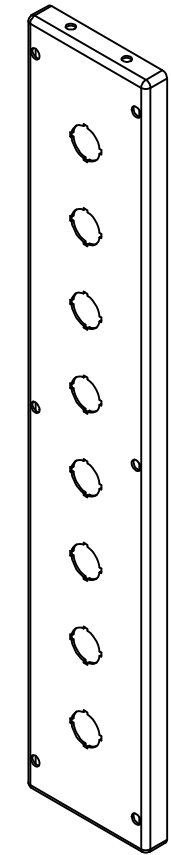

Isometric View

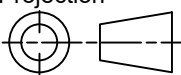

| | |
|--|---|
|  Tél: (450) 979-4373 Fax: (450) 979-4626 www.exmweb.com | Flatness Aplatissement |
| | Max 3.0mm |
| Projection |  |
| Customer Client | Date |
| Drawn By Dessiné Par | Date 24-May-23 |
| Material Matière | 16 Ga Cold Rolled A1008 CS Type B (1.4mm) |
| Color Couleur | Asa-61 Grey |
| Finish Fini | Smooth |
| Description | Detail Rev. |
| Part Number Numéro Pièce | Rev. 9 |
| 1412SD200302MNC | 0 9 |

| Qty | Part Number | Rev | Description |
|------------|-------------------|-----|-------------------------------------|
| 1 | STK-P-02400S | 0 | Powder Paint (Asa-61 Grey / Smooth) |
| 1 | 1412SD200302MNG | 0 | 1412SD 20.75" x 3.5" Gasket |
| 1 | 1412SD200302MNC-P | 0 | 1412SDMN 20.75" x 3.5" Cover Part |
| Parts List | | | |