

This drawing is confidential and must not be reproduced or used without the consent of EXM

Ce dessin est confidentiel et ne doit pas être reproduit ou utilisé sans le consentement de EXM

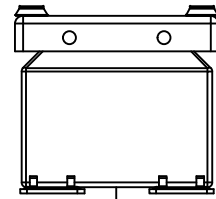

TOP

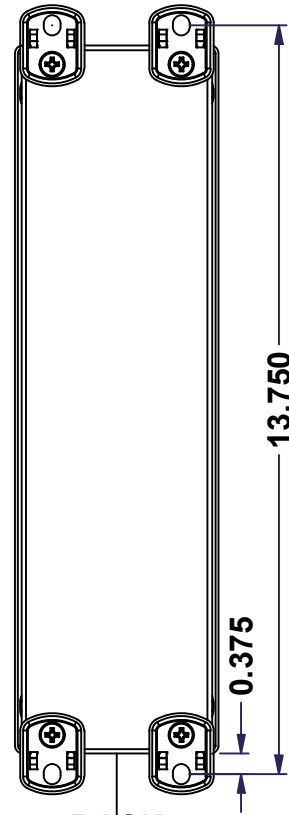

BACK

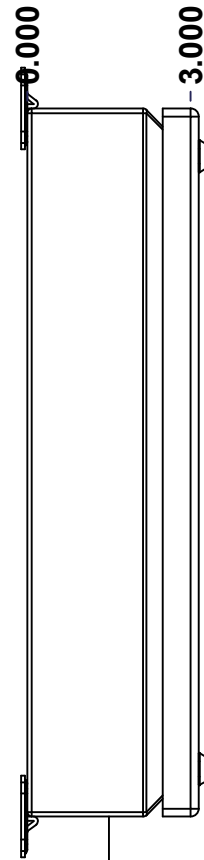

LEFT

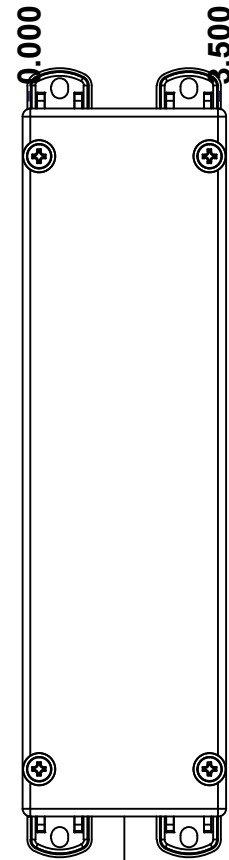

FRONT

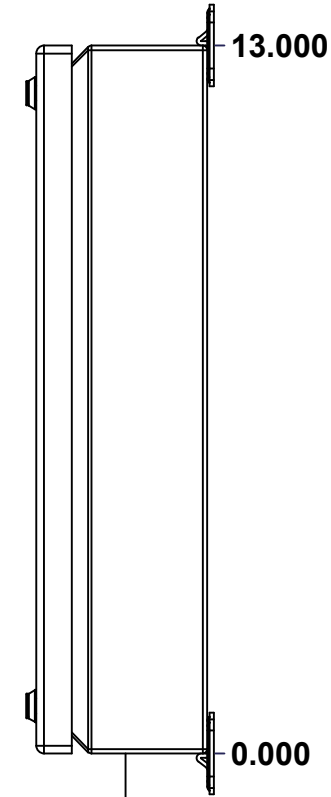

RIGHT

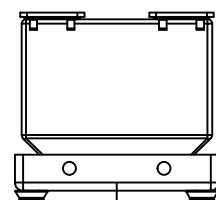

BOTTOM

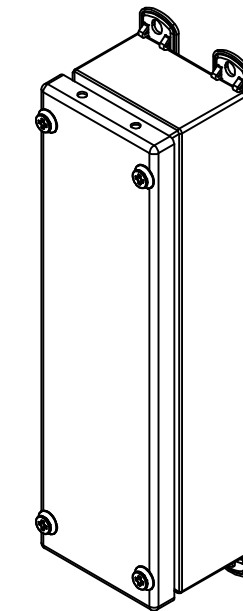

Isometric View

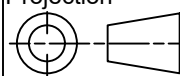

No.	Revisions	Date	By/Par

 Tél: (450) 979-4373 Fax: (450) 979-4626 <a href="http://www.exmweb.com">www.exmweb.com</a>		Flatness Aplatissement Max 3.0mm Projection 
Customer Client		Date
Drawn By Dessiné Par	BoxCad: BoxCad	Date 19-Aug-21
Material Matière	16 Ga Cold Rolled A1008 CS Type B (1.4mm)	
Color Couleur	Asa-61 Grey	Finish Fini Smooth
Description 1412SDC 13" x 3.5" x 3" Assembly		Detail Rev.
Part Number Numéro Pièce	1412SDC120302	Rev. 1 0

SEE BILL OF MATERIAL ON LAST PAGE

This drawing is confidential and must not be reproduced or used without the consent of EXM

Ce dessin est confidentiel et ne doit pas être reproduit ou utilisé sans le consentement de EXM

NOTE	
ITEM	DESCRIPTION
1	NEMA 4, 12 Enclosure (IP66)
2	C/W Standard ground standoffs on box and cover
3	W/O Standard door stiffener
4	W/O Inner panel
5	W/O Inner panel mounting standoffs
6	C/W 885 ESCHMF1 Mounting Feet (Installed)

No.	Revisions	Date	By/Par

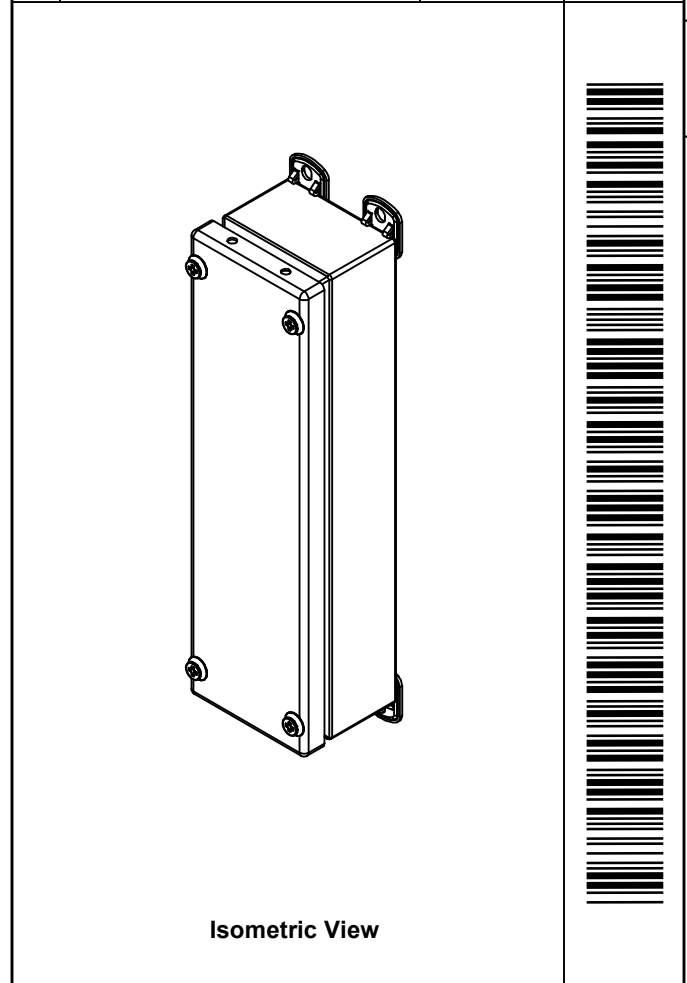

	Tél: (450) 979-4373 Fax: (450) 979-4626 <a href="http://www.exmweb.com">www.exmweb.com</a>	Flatness Aplatissement Max 3.0mm
		Projection 
Customer Client		Date
Drawn By Dessiné Par	BoxCad: BoxCad	Date 19-Aug-21
Material Matière	16 Ga Cold Rolled A1008 CS Type B (1.4mm)	
Color Couleur	Asa-61 Grey	Finish Fini Smooth
Description	1412SDC 13" x 3.5" x 3" Assembly	
Part Number Numéro Pièce	<b>1412SDC120302</b>	Rev. 2 <b>0</b>

PACKING		
ITEM	QTY	DESCRIPTION
Cardboard sleeve	2	Top and Bottom
Cardboard strip	2	Between back of enclosure and inner panel
Plastic bag	1	To protect cover surface and inside gasket
Plastic strap - Black	2	To Squeeze the 2 cardboard sleeve together
Packaging label	1	White label with product number

Qty	Part Number	Rev	Description
1	STK-K-02920	3	5412 ESSC Accessory Kit
1	1412SDC120302C	0	1412SDC 13" x 3.5" Cover
1	1412SDC120302B	0	1412SDC 13" x 3.5" x 3" Body
Parts List			

This drawing is confidential and must not be reproduced or used without the consent of EXM

Ce dessin est confidentiel et ne doit pas être reproduit ou utilisé sans le consentement de EXM

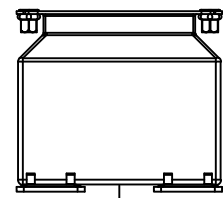

TOP

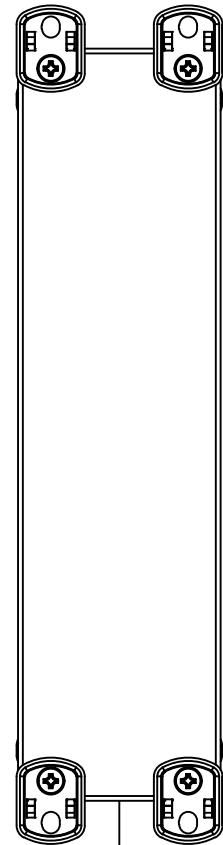

BACK

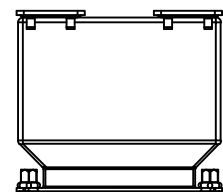

BOTTOM

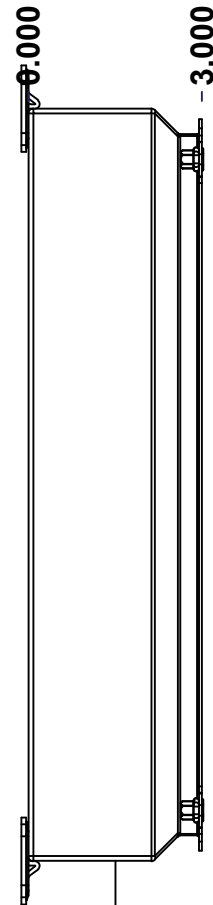

LEFT

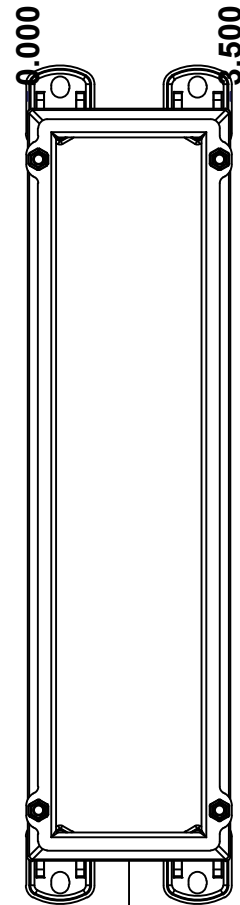

FRONT

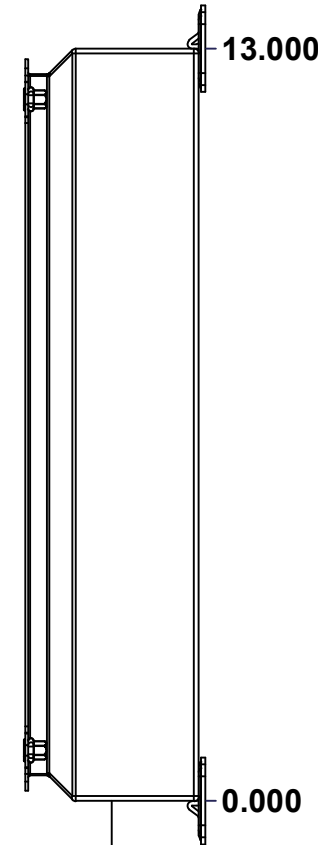

RIGHT

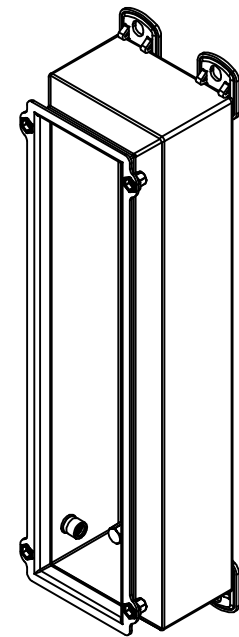

Isometric View

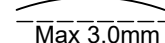
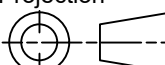

No.	Revisions	Date	By/Par

 Tél: (450) 979-4373 Fax: (450) 979-4626 <a href="http://www.exmweb.com">www.exmweb.com</a>		Flatness Aplatissement  Max 3.0mm Projection 
Customer Client	Date	
Drawn By Dessiné Par	BoxCad: BoxCad	Date 19-Aug-21
Material Matière	16 Ga Cold Rolled A1008 CS Type B (1.4mm)	
Color Couleur	Asa-61 Grey	Finish Fini Smooth
Description	Detail Rev.	
1412SDC 13" x 3.5" x 3" Body		
Part Number Numéro Pièce	Rev.	3
1412SDC120302B	0	9

SEE BILL OF MATERIAL ON LAST PAGE

This drawing is confidential and must not be reproduced or used without the consent of EXM

Ce dessin est confidentiel et ne doit pas être reproduit ou utilisé sans le consentement de EXM

<b>STANDARD FEATURES ARE NOT LISTED IN THIS HOLE TABLE</b>			
<b>HOLE TABLE - LEFT VIEW (CUSTOM FEATURE ONLY)</b>			
CUT-OUT	XDIM	YDIM	DESCRIPTION
1	1.625	0.875	STANDOFF M6 x 10mm (Inside)

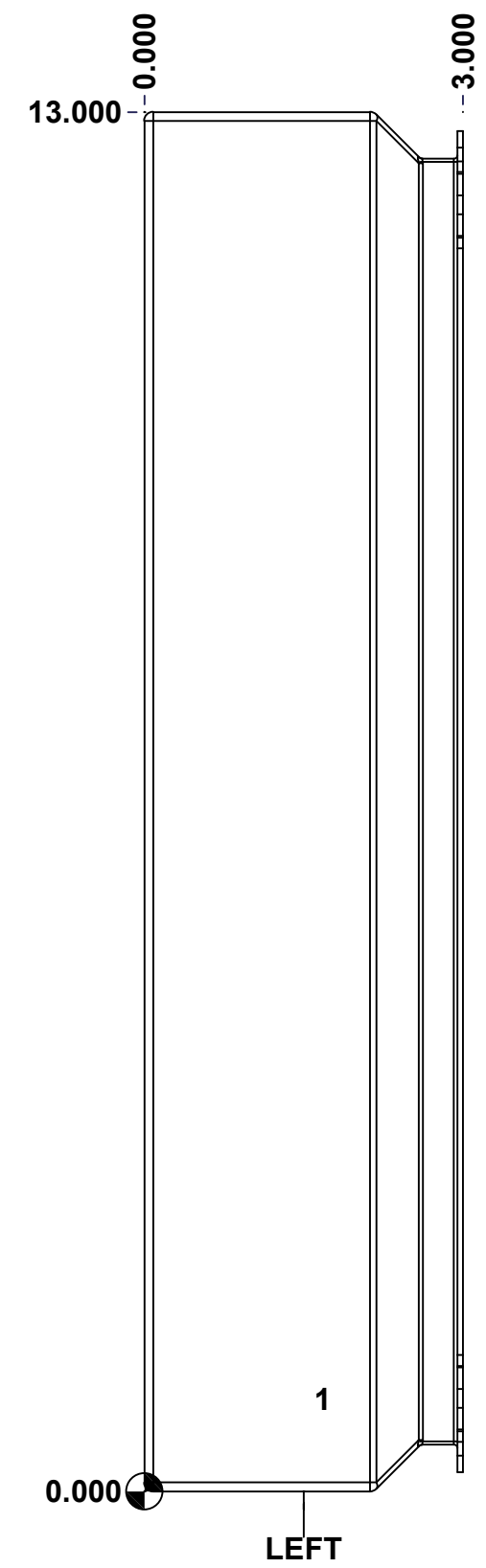

	Description	Status	
	1412SDC 13" x 3.5" x 3" Body	(NULL)	
	Part Number Numéro Pièce	Rev.	
	<b>1412SDC120302B</b>	<b>0</b>	4 9

This drawing is confidential and must not be reproduced or used without the consent of EXM

Ce dessin est confidentiel et ne doit pas être reproduit ou utilisé sans le consentement de EXM

**STANDARD FEATURES ARE NOT LISTED IN THIS HOLE TABLE**

**HOLE TABLE - BACK VIEW (CUSTOM FEATURE ONLY)**

CUT-OUT	XDIM	YDIM	DESCRIPTION
1	2.937	13.000	FOOT 885 ESCHMF1
2	0.563	13.000	FOOT 885 ESCHMF1
3	2.937	0.000	FOOT 885 ESCHMF1
4	0.563	0.000	FOOT 885 ESCHMF1
5	2.937	12.656	RIVET NUT M6_FH_CE (Inside)
6	0.563	12.656	RIVET NUT M6_FH_CE (Inside)
7	2.937	0.344	RIVET NUT M6_FH_CE (Inside)
8	0.563	0.344	RIVET NUT M6_FH_CE (Inside)

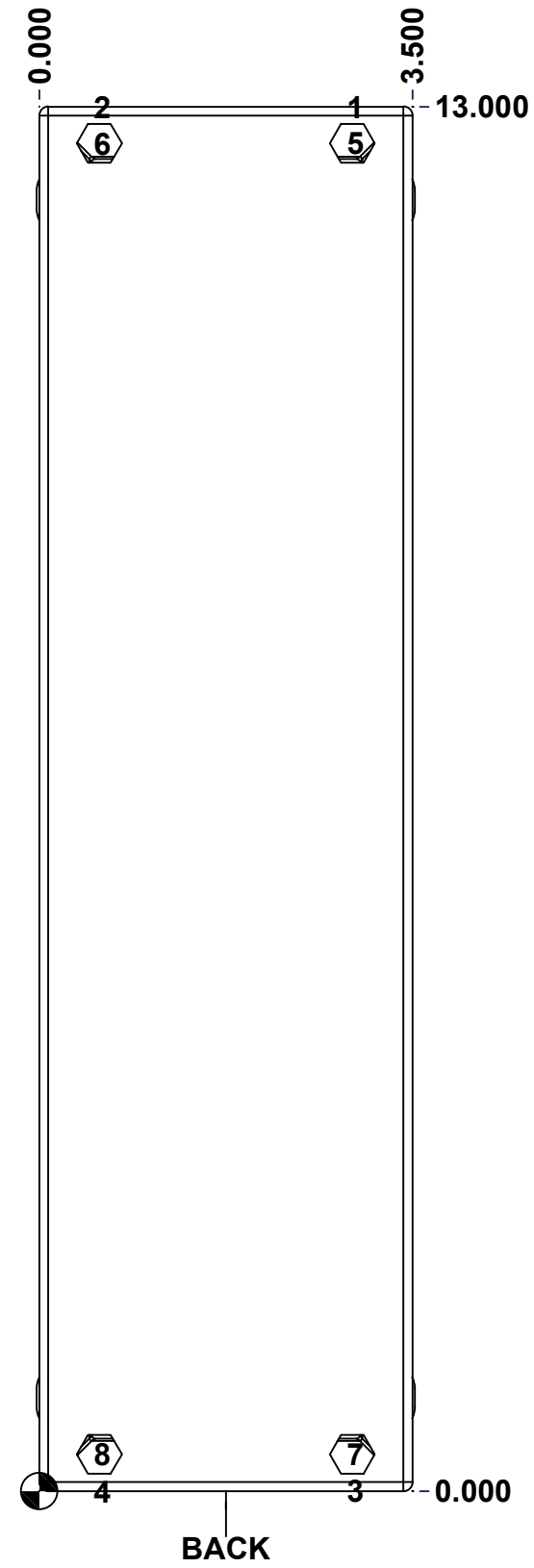

	Description	Status	
	1412SDC 13" x 3.5" x 3" Body	(NULL)	
	Part Number Numéro Pièce	Rev.	
	<b>1412SDC120302B</b>	<b>0</b>	5 9

This drawing is confidential and must not be reproduced or used without the consent of EXM

Ce dessin est confidentiel et ne doit pas être reproduit ou utilisé sans le consentement de EXM

No.	Revisions	Date	By/Par

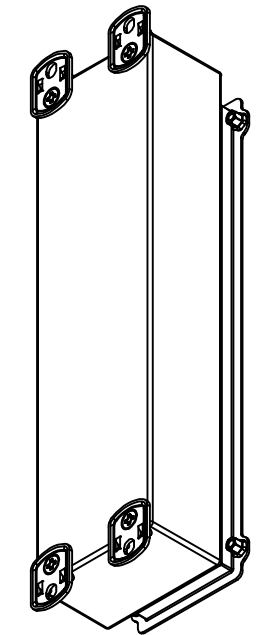

Isometric View

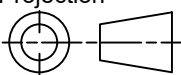

 Tél: (450) 979-4373 Fax: (450) 979-4626 <a href="http://www.exmweb.com">www.exmweb.com</a>	Flatness Aplatissement	Max 3.0mm
	Projection	
Customer Client	Date	
Drawn By Dessiné Par	BoxCad: BoxCad	Date 19-Aug-21
Material Matière	16 Ga Cold Rolled A1008 CS Type B (1.4mm)	
Color Couleur	Asa-61 Grey	Finish Fini Smooth
Description	Detail Rev.	
1412SDC 13" x 3.5" x 3" Body		
Part Number Numéro Pièce	Rev.	6
<b>1412SDC120302B</b>	<b>0</b>	9

Qty	Part Number	Rev	Description
4	STK-Q-03071	0	M6 x 16mm Machine Screw
4	RIVET_NUT_M6_FH_CE	0	Rivet Nut M6 (Low Profile Close End)
4	885 ESCHMF1	2	5412 ESCH Stamped Mounting Foot
1	STK-P-02400S	0	Powder Paint (Asa-61 Grey / Smooth)
1	1412SDC120302B-P	0	1412SDC 13" x 3.5" x 3" Body Part
1	STK-Q-08350	5	Standoff M6 x 10mm
4	RIVET_NUT_M5_FH_OE	0	Rivet Nut M5 (Low Profile Open End)
Parts List			

This drawing is confidential and must not be reproduced or used without the consent of EXM

Ce dessin est confidentiel et ne doit pas être reproduit ou utilisé sans le consentement de EXM

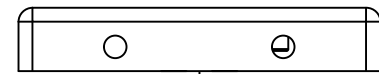

TOP

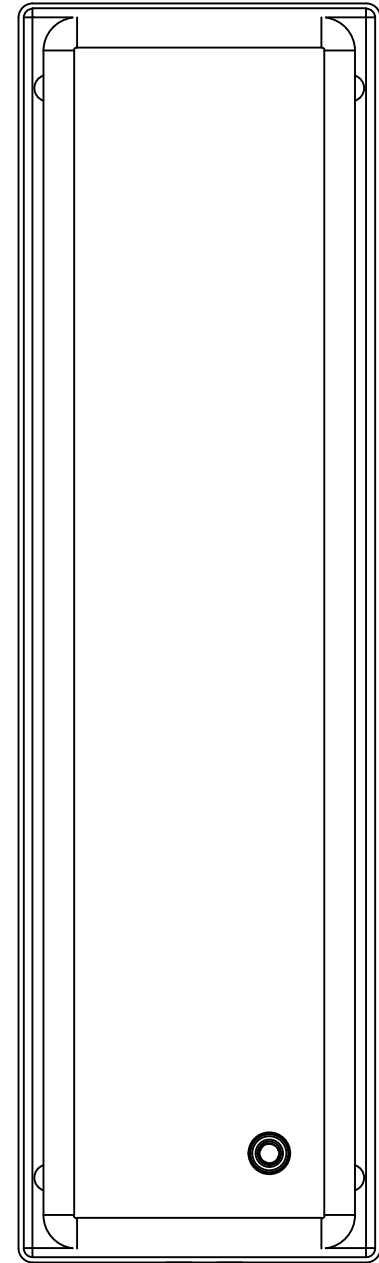

BACK

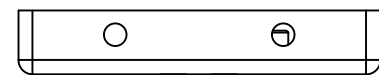

BOTTOM

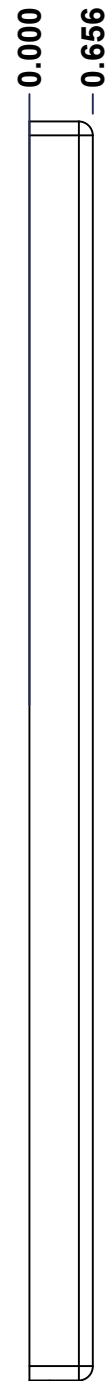

LEFT

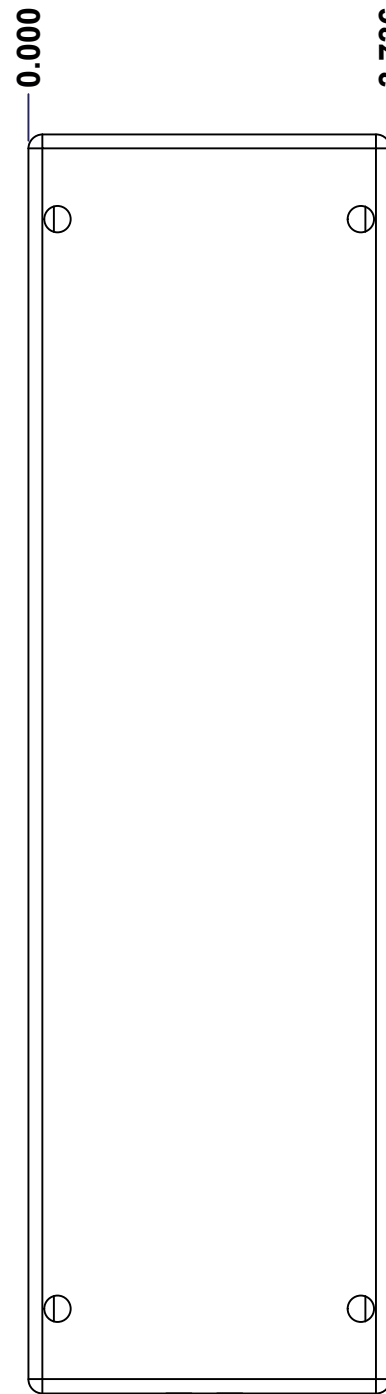

FRONT

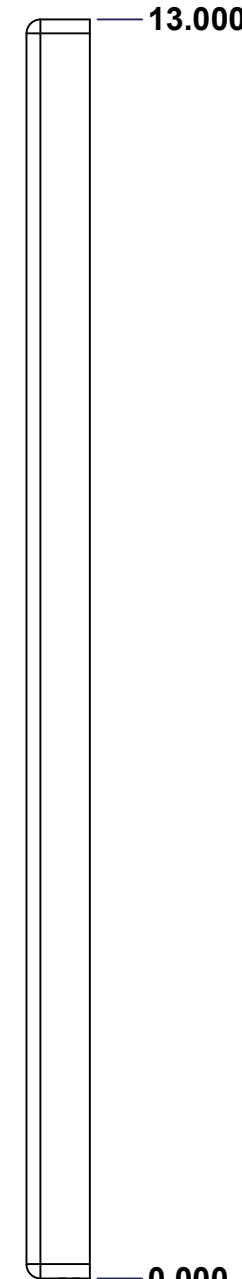

RIGHT

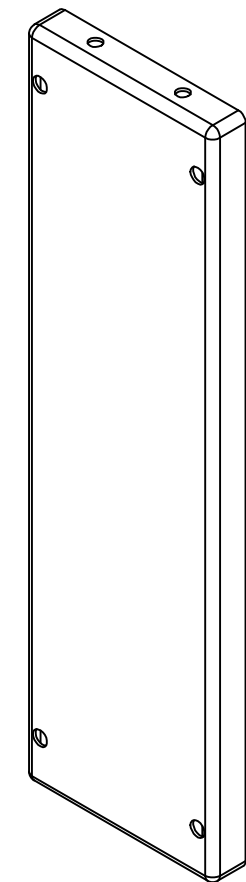

Isometric View

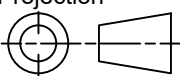

No.	Revisions	Date	By/Par

 Tél: (450) 979-4373 Fax: (450) 979-4626 <a href="http://www.exmweb.com">www.exmweb.com</a>		Flatness Aplatissement Max 3.0mm Projection 
Customer Client	Date	Date 19-Aug-21
Drawn By Dessiné Par	BoxCad: BoxCad	
Material Matière	16 Ga Cold Rolled A1008 CS Type B (1.4mm)	
Color Couleur	Asa-61 Grey	Finish Fini Smooth
Description	1412SDC 13" x 3.5" Cover	
Part Number Numéro Pièce	Rev. 0	7 9

SEE BILL OF MATERIAL ON LAST PAGE

**1412SDC120302C**

This drawing is confidential and must not be reproduced or used without the consent of EXM

Ce dessin est confidentiel et ne doit pas être reproduit ou utilisé sans le consentement de EXM

STANDARD FEATURES ARE NOT LISTED IN THIS HOLE TABLE			
HOLE TABLE - FRONT VIEW (CUSTOM FEATURE ONLY)			
CUT-OUT	XDIM	YDIM	DESCRIPTION
1	1.145	1.125	STANDOFF M6 x 10mm (Inside)

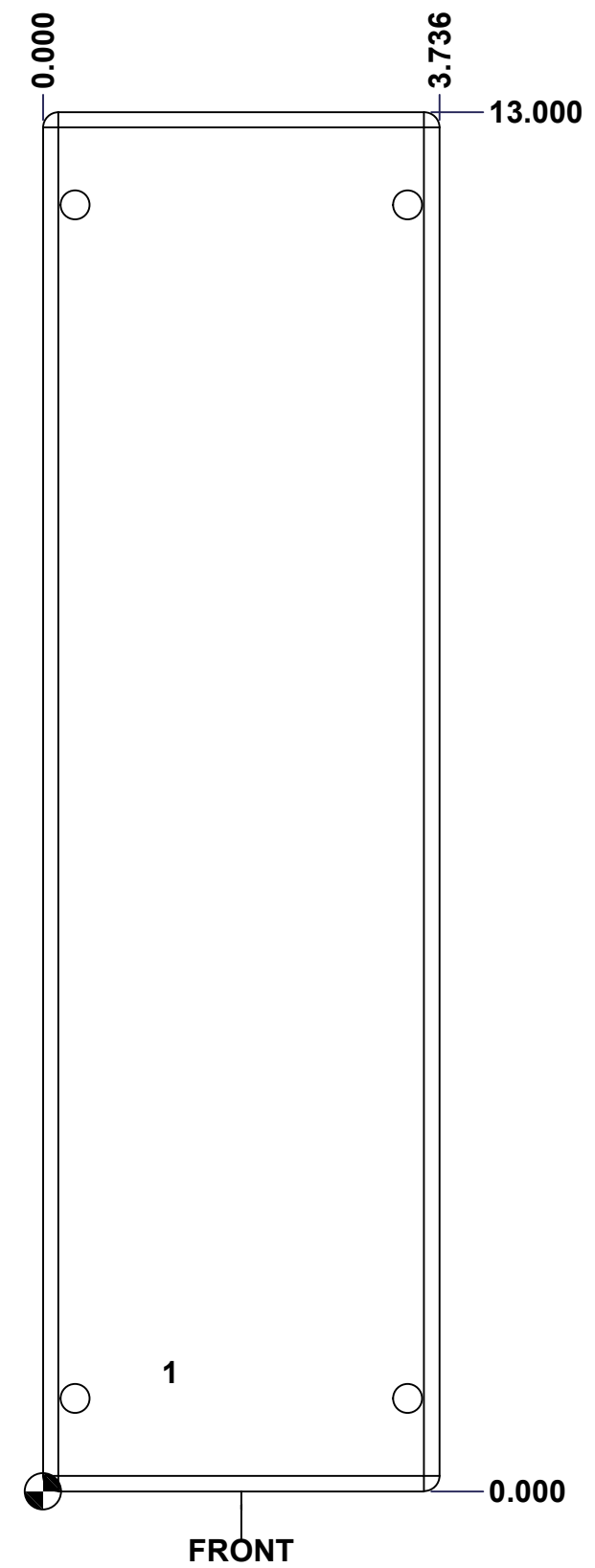

	Description	Status
	1412SDC 13" x 3.5" Cover	(NULL)
	Part Number Numéro Pièce	Rev.
	<b>1412SDC120302C</b>	<b>0</b>
		8
		9

This drawing is confidential and must not be reproduced or used without the consent of EXM

Ce dessin est confidentiel et ne doit pas être reproduit ou utilisé sans le consentement de EXM

No.	Revisions	Date	By/Par

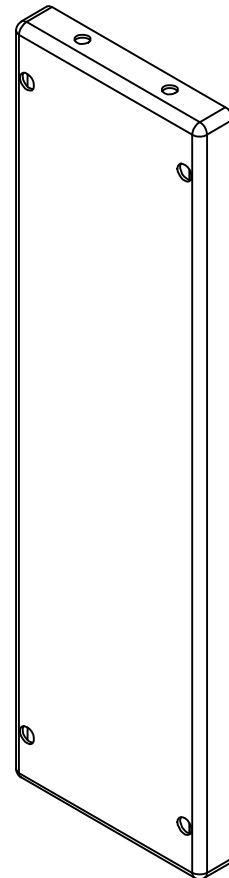

**Isometric View**

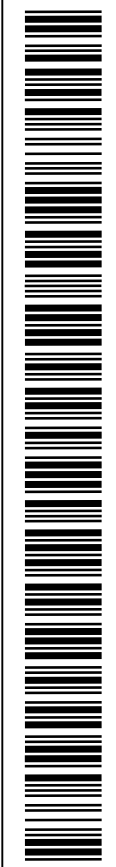

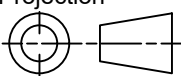
		Tél: (450) 979-4373 Fax: (450) 979-4626 <a href="http://www.exmweb.com">www.exmweb.com</a>		Flatness Aplatissement Max 3.0mm	
Projection 		Customer Client		Date	
Drawn By / Dessiné Par		BoxCad: BoxCad		Date 19-Aug-21	
Material / Matière		16 Ga Cold Rolled A1008 CS Type B (1.4mm)			
Color / Couleur		Asa-61 Grey		Finish / Fini Smooth	
Description				Detail Rev.	
1412SDC 13" x 3.5" Cover					
Part Number / Numéro Pièce		<b>1412SDC120302C</b>		Rev.	9
				<b>0</b>	9

1	STK-Q-08350	5	Standoff M6 x 10mm
1	STK-P-02400S	0	Powder Paint (Asa-61 Grey / Smooth)
1	1412SDC120302G	0	1412SD 13" x 3.5" Gasket
1	1412SDC120302C-P	0	1412SDC 13" x 3.5" Cover Part
Qty	Part Number	Rev	Description
Parts List			