

This drawing is confidential and must not be reproduced or used without the consent of EXM

Ce dessin est confidentiel et ne doit pas être reproduit ou utilisé sans le consentement de EXM

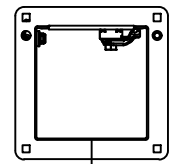

TOP

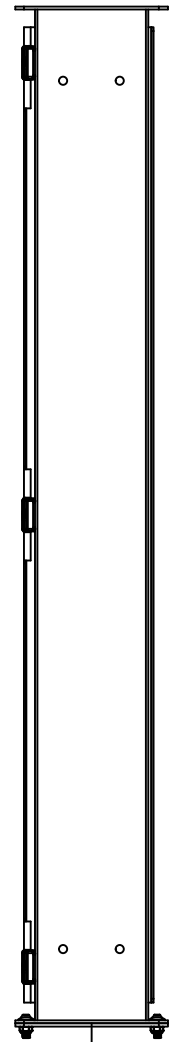

BACK

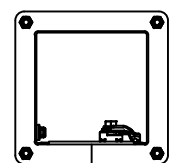

BOTTOM

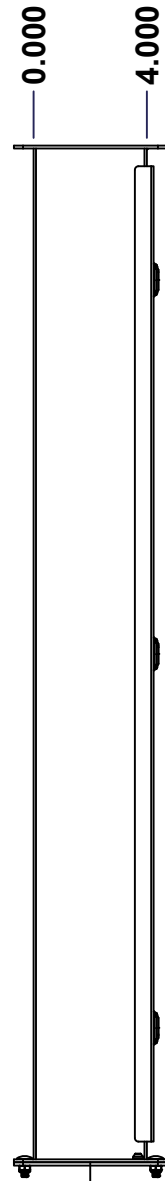

LEFT

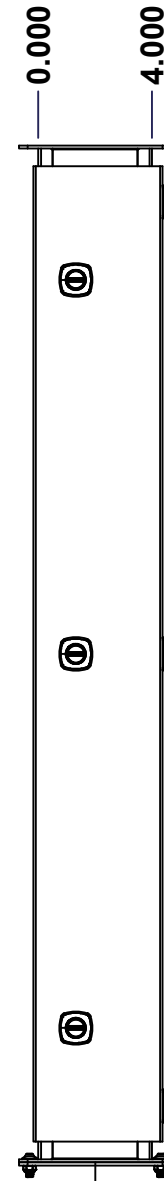

FRONT

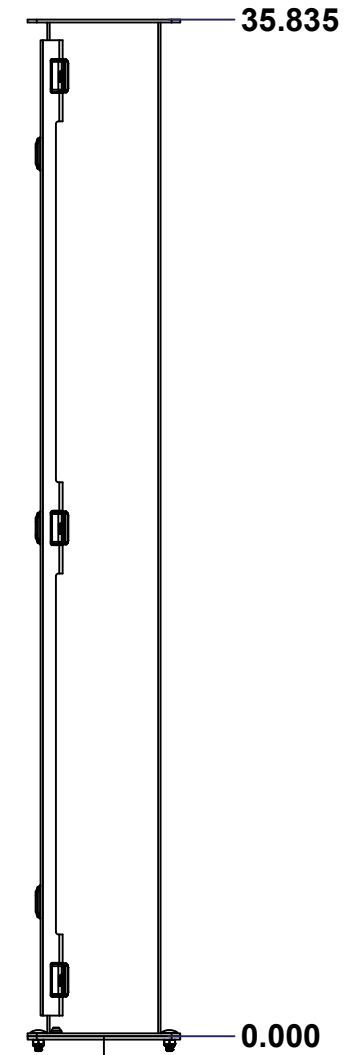

RIGHT

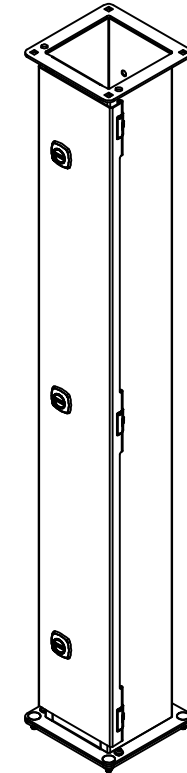

Isometric View

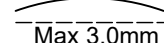

| No. | Revisions | Date | By/Par |
|-----|-----------|------|--------|
| | | | |
| | | | |
| | | | |
| | | | |

| | | |
|--|-----------------------|---|
|  Tél: (450) 979-4373 Fax: (450) 979-4626 www.exmweb.com | | Flatness Aplatissement  Max 3.0mm |
| Customer Client | | Date |
| Drawn By / Dessiné Par: BoxCad: BoxCad | | Date: 16-Jul-25 |
| Material / Matière: 16 Ga Cold Rolled A1008 CS Type B (1.4mm) | | |
| Color / Couleur: Asa-61 Grey | Finish / Fini: Smooth | |
| Description: 1412SS 36" x 4" x 4" Assembly | | Detail Rev. |
| Part Number / Numéro Pièce: 1412SS4036 | | Rev. 1 0 |

SEE BILL OF MATERIAL ON LAST PAGE

1412SS4036

This drawing is confidential and must not be reproduced or used without the consent of EXM

Ce dessin est confidentiel et ne doit pas être reproduit ou utilisé sans le consentement de EXM

| NOTE | |
|------|-----------------------------|
| ITEM | DESCRIPTION |
| 1 | NEMA 4, 12 Enclosure (IP66) |

| No. | Revisions | Date | By/Par |
|-----|-----------|------|--------|
| | | | |
| | | | |
| | | | |
| | | | |

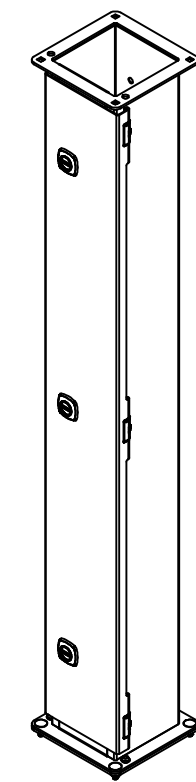

Isometric View

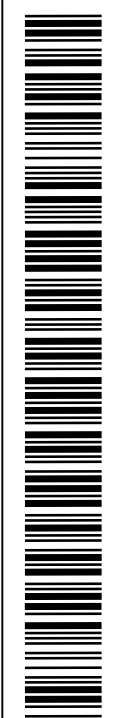

 Tél: (450) 979-4373
 Fax: (450) 979-4626
www.exmweb.com

Flatness / Aplatissement: Max 3.0mm
 Projection: 

| | |
|--|-----------------|
| Customer Client | Date |
| Drawn By / Dessiné Par: BoxCad: BoxCad | Date: 16-Jul-25 |

Material / Matière: 16 Ga Cold Rolled A1008 CS Type B (1.4mm)

| | |
|------------------------------|-----------------------|
| Color / Couleur: Asa-61 Grey | Finish / Fini: Smooth |
|------------------------------|-----------------------|

| | |
|--|-------------|
| Description: 1412SS 36" x 4" x 4" Assembly | Detail Rev. |
|--|-------------|

| | | |
|---|--------|-------|
| Part Number / Numéro Pièce: 1412SS4036 | Rev. 0 | 2 / 8 |
|---|--------|-------|

| Qty | Part Number | Rev | Description |
|-----|-------------|-----|---|
| 4 | STK-Q-00266 | 0 | M6 x 16mm Stainless Steel 316 Carriage Bolt |
| 1 | STK-G-01610 | 1 | 1412 Pull Through Wireway Gasket |
| 1 | 1412SS4036C | 0 | 1412SS 36" x 4" Cover |
| 1 | 1412SS4036B | 0 | 1412SS 36" x 4" x 4" Body |
| 3 | STK-A-08126 | 0 | M5 Stainless Steel 316 Nylon Insert Lock Nut with Incorporated Sealing Washer |
| 4 | STK-Q-07225 | 0 | M6 Stainless Steel Nylon Insert Lock Nut |

Parts List

| PACKING | | |
|-----------------------|-----|--|
| ITEM | QTY | DESCRIPTION |
| Cardboard sleeve | 2 | Top and Bottom |
| Plastic strap - Black | 2 | To Squeeze 2 cardboard sleeve together |
| Packaging label | 3 | White label with PN |

This drawing is confidential and must not be reproduced or used without the consent of EXM

Ce dessin est confidentiel et ne doit pas être reproduit ou utilisé sans le consentement de EXM

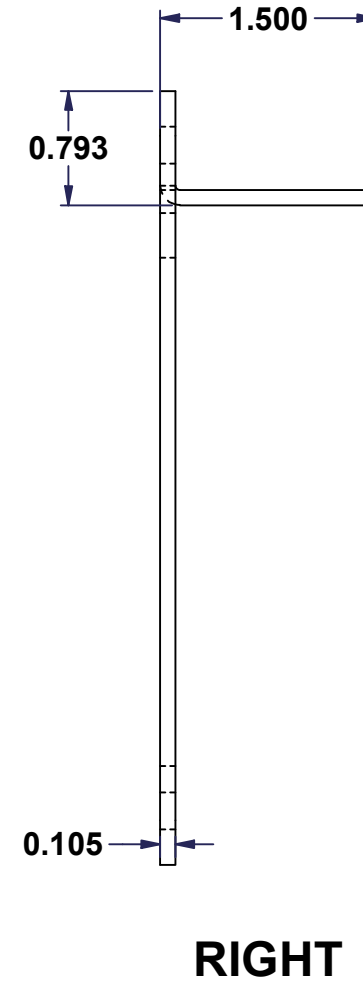
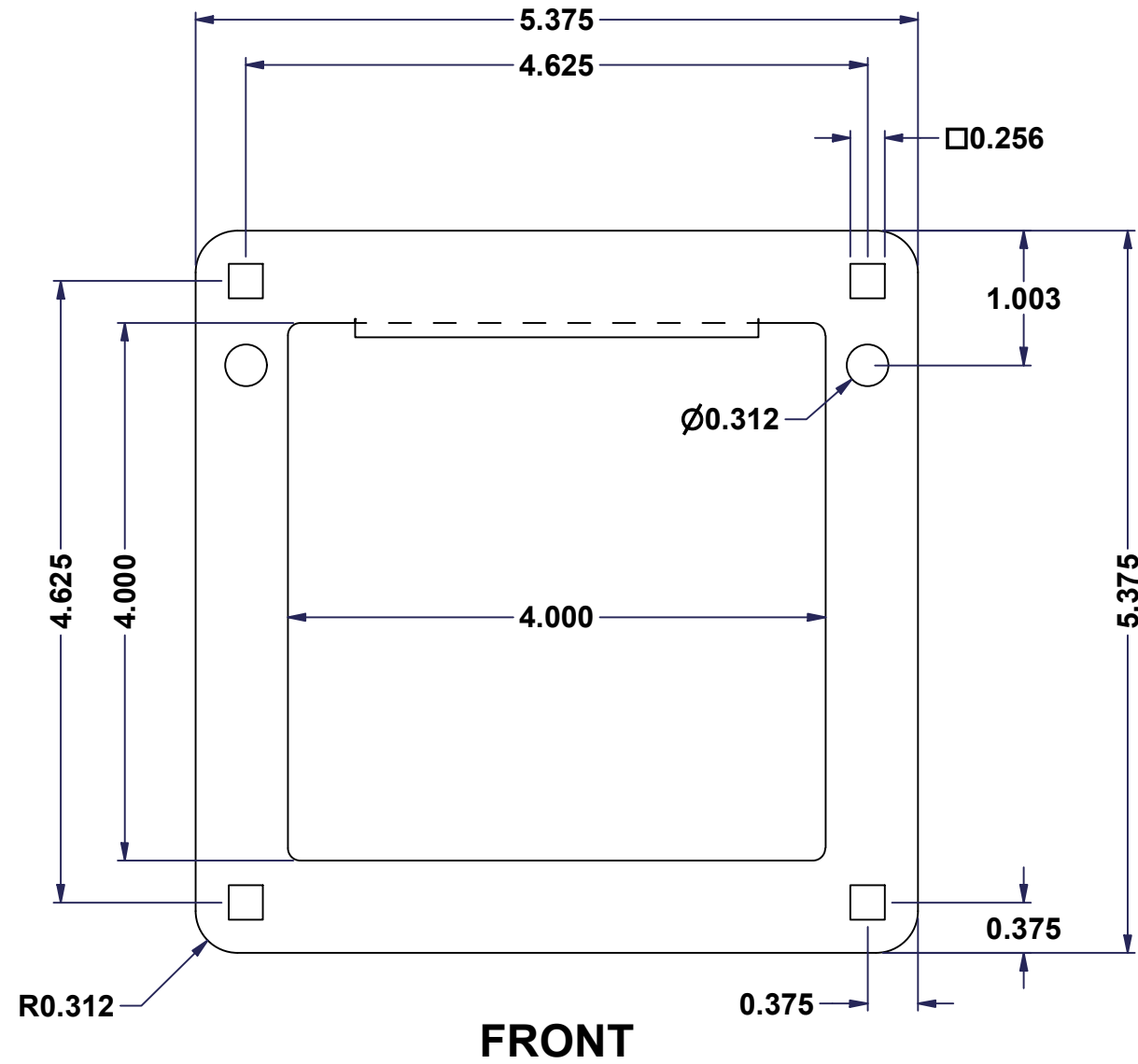

| No. | Revisions | Date | By/Par |
|-----|-----------|------|--------|
| | | | |
| | | | |
| | | | |
| | | | |
| | | | |

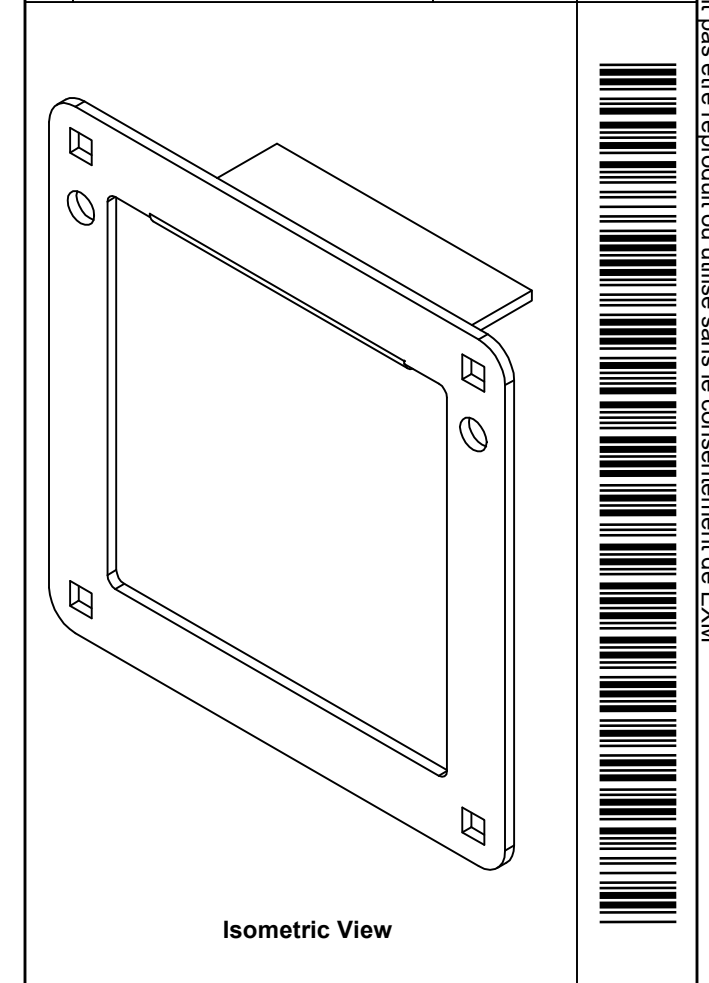

| | | |
|--|---|--|
| Tél: (450) 979-4373 Fax: (450) 979-4626 www.exmweb.com | | Flatness Aplatissement Max 3.0mm Projection |
| Customer Client | Date | |
| Drawn By Dessiné Par | BoxCad: BoxCad | Date 16-Jul-25 |
| Material Matière | 12 Ga Cold Rolled A1008 CS Type B (2.5mm) | |
| Color Couleur | Asa-61 Grey | Finish Fini Smooth |
| Description 1412SS4" x 4" Connector Part | | Detail Rev. |
| Part Number Numéro Pièce | 1412SS4036BC-P | Rev. 3 0 |

This drawing is confidential and must not be reproduced or used without the consent of EXM

Ce dessin est confidentiel et ne doit pas être reproduit ou utilisé sans le consentement de EXM

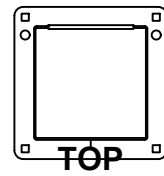

TOP

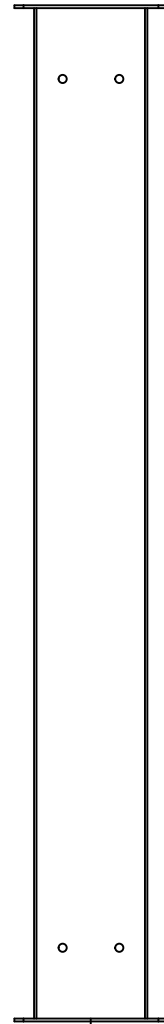

BACK

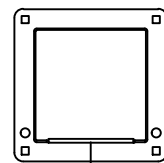

BOTTOM

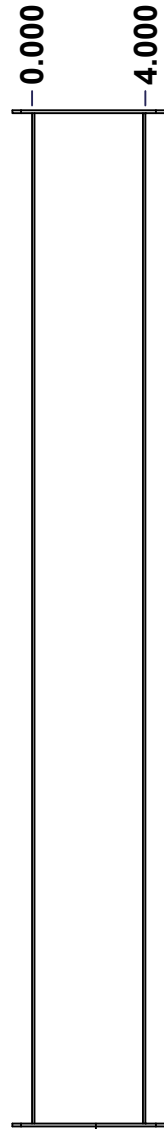

LEFT

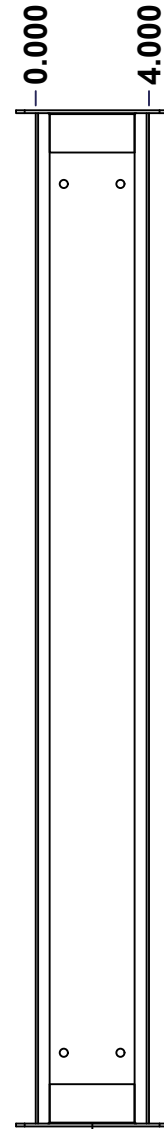

FRONT

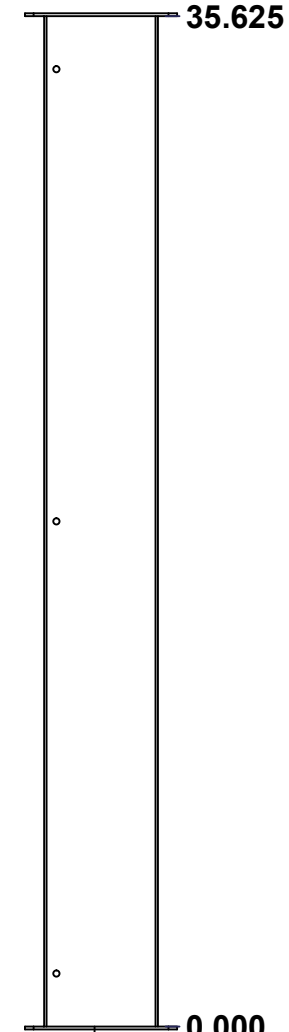

RIGHT

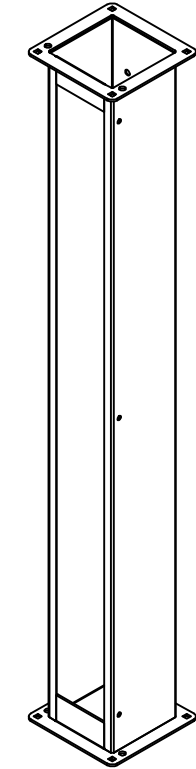

Isometric View

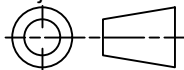

| No. | Revisions | Date | By/Par |
|-----|-----------|------|--------|
| | | | |
| | | | |
| | | | |
| | | | |
| | | | |

| | | |
|--|---|---|
|  Tél: (450) 979-4373 Fax: (450) 979-4626 www.exmweb.com | | Flatness Aplatissement Max 3.0mm Projection  |
| Customer Client | Date | |
| Drawn By Dessiné Par | BoxCad: BoxCad | Date 16-Jul-25 |
| Material Matière | 16 Ga Cold Rolled A1008 CS Type B (1.4mm) | |
| Color Couleur | Asa-61 Grey | Finish Fini Smooth |
| Description 1412SS 36" x 4" x 4" Body | | Detail Rev. |
| Part Number Numéro Pièce | 1412SS4036B | Rev. 4 0 |

SEE BILL OF MATERIAL ON LAST PAGE

This drawing is confidential and must not be reproduced or used without the consent of EXM

Ce dessin est confidentiel et ne doit pas être reproduit ou utilisé sans le consentement de EXM

| No. | Revisions | Date | By/Par |
|-----|-----------|------|--------|
| | | | |
| | | | |
| | | | |
| | | | |
| | | | |

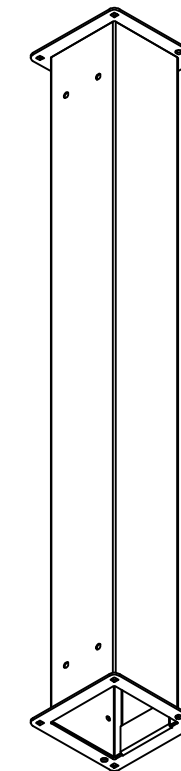

Isometric View

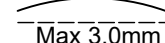

| | | |
|--|-----------------------|---|
|  Tél: (450) 979-4373 Fax: (450) 979-4626 www.exmweb.com | | Flatness Aplatissement  Max 3.0mm |
| Customer Client | | Date |
| Drawn By / Dessiné Par: BoxCad: BoxCad | | Date: 16-Jul-25 |
| Material / Matière: 16 Ga Cold Rolled A1008 CS Type B (1.4mm) | | |
| Color / Couleur: Asa-61 Grey | Finish / Fini: Smooth | |
| Description: 1412SS 36" x 4" x 4" Body | | Detail Rev. |
| Part Number / Numéro Pièce: 1412SS4036B | | Rev. 0 / 5 |

| Qty | Part Number | Rev | Description |
|------------|----------------|-----|-------------------------------------|
| 1 | STK-P-02400S | 0 | Powder Paint (Asa-61 Grey / Smooth) |
| 2 | 1412SS4036BC-P | 0 | 1412SS4" x 4" Connector Part |
| 1 | 1412SS4036B-P | 0 | 1412SS 36" x 4" x 4" Body Part |
| Parts List | | | |

This drawing is confidential and must not be reproduced or used without the consent of EXM

Ce dessin est confidentiel et ne doit pas être reproduit ou utilisé sans le consentement de EXM

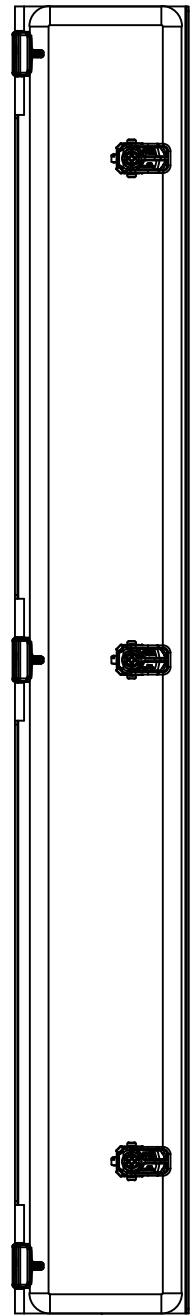

BACK



BOTTOM

0.000
0.660



LEFT

0.000
4.565

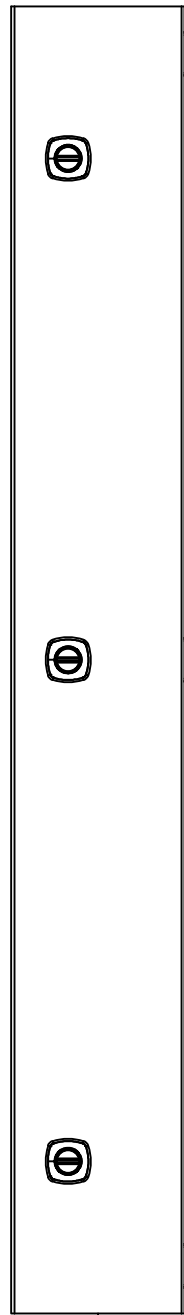

FRONT

34.375



RIGHT

0.000

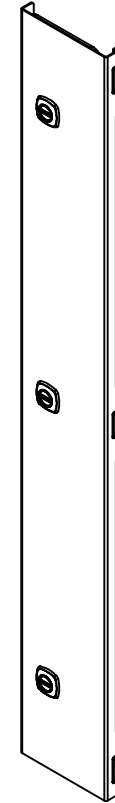

Isometric View

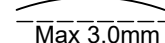
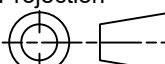

| No. | Revisions | Date | By/Par |
|-----|-----------|------|--------|
| | | | |
| | | | |
| | | | |
| | | | |
| | | | |

| | | |
|--|-----------------------|---|
|  Tél: (450) 979-4373 Fax: (450) 979-4626 www.exmweb.com | | Flatness Aplatissement  Max 3.0mm |
| Projection  | | Date 16-Jul-25 |
| Customer Client | Date | |
| Drawn By / Dessiné Par: BoxCad: BoxCad | Date: 16-Jul-25 | |
| Material / Matière: 16 Ga Cold Rolled A1008 CS Type B (1.4mm) | Date | |
| Color / Couleur: Asa-61 Grey | Finish / Fini: Smooth | Date |
| Description: 1412SS 36" x 4" Cover | | Detail Rev. |
| Part Number / Numéro Pièce: 1412SS4036C | Rev. 0 | 6 / 8 |

SEE BILL OF MATERIAL ON LAST PAGE

This drawing is confidential and must not be reproduced or used without the consent of EXM

Ce dessin est confidentiel et ne doit pas être reproduit ou utilisé sans le consentement de EXM

| STANDARD FEATURES ARE NOT LISTED IN THIS HOLE TABLE | | | |
|---|-------|--------|-----------------------------|
| HOLE TABLE - FRONT VIEW (CUSTOM FEATURE ONLY) | | | |
| CUT-OUT | XDIM | YDIM | DESCRIPTION |
| 1 | 3.065 | 30.375 | LOCK 880 SCQ4CH-SL @ 180.0° |
| 2 | 3.065 | 17.188 | LOCK 880 SCQ4CH-SL @ 180.0° |
| 3 | 3.065 | 4.000 | LOCK 880 SCQ4CH-SL @ 180.0° |

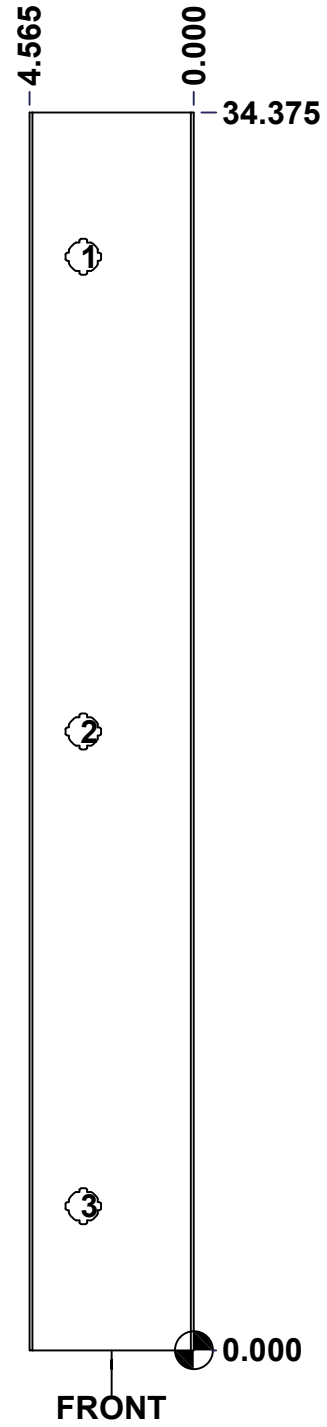

| | | | |
|--|-----------------------------|----------|--------|
| | Description | Status | |
| | 1412SS 36" x 4" x 4" Cover | (NULL) | |
| | Part Number Numéro Pièce | Rev. | |
| | 1412SS4036C | 0 | 7 8 |

This drawing is confidential and must not be reproduced or used without the consent of EXM

Ce dessin est confidentiel et ne doit pas être reproduit ou utilisé sans le consentement de EXM

| No. | Revisions | Date | By/Par |
|-----|-----------|------|--------|
| | | | |
| | | | |
| | | | |
| | | | |
| | | | |

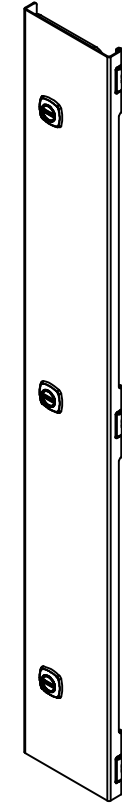

Isometric View

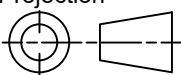

| | | |
|--|-----------------------|---|
|  Tél: (450) 979-4373 Fax: (450) 979-4626 www.exmweb.com | | Flatness Aplatissement Max 3.0mm Projection  |
| Customer Client | Date | |
| Drawn By / Dessiné Par: BoxCad: BoxCad | Date: 16-Jul-25 | |
| Material / Matière: 16 Ga Cold Rolled A1008 CS Type B (1.4mm) | | |
| Color / Couleur: Asa-61 Grey | Finish / Fini: Smooth | |
| Description: 1412SS 36" x 4" Cover | | Detail Rev. |
| Part Number / Numéro Pièce: 1412SS4036C | Rev.: | 8 |
| | | 0 |
| | | 8 |

| Qty | Part Number | Rev | Description |
|------------|---------------|-----|-------------------------------------|
| 1 | 1412SS4036G | 0 | 1412SS 36" x 4" Cover Gasket Part |
| 1 | STK-P-02400S | 0 | Powder Paint (Asa-61 Grey / Smooth) |
| 1 | 1412SS4036C-P | 0 | 1412SS 36" x 4" x 4" Cover Part |
| 3 | STK-A-33033 | 4 | 5412 ESMCH Hinge |
| 3 | 880 SCQ4CH-SL | 0 | 5412 CH 1/4 Turn Lock |
| Parts List | | | |