

This drawing is confidential and must not be reproduced or used without the consent of EXM

Ce dessin est confidentiel et ne doit pas être reproduit ou utilisé sans le consentement de EXM

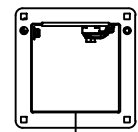

TOP

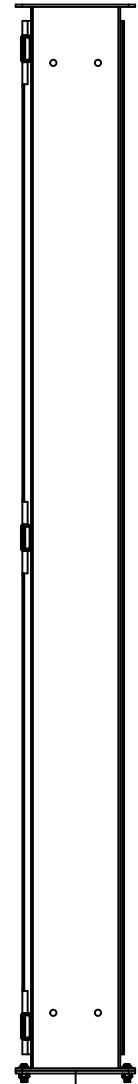

BACK

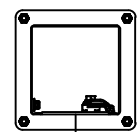

BOTTOM

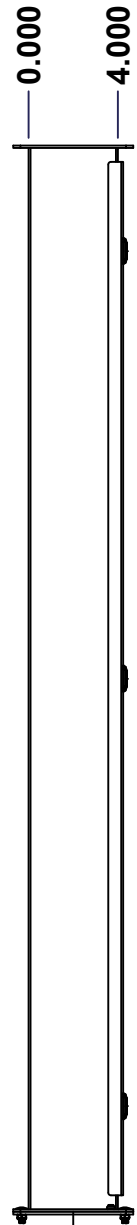

LEFT

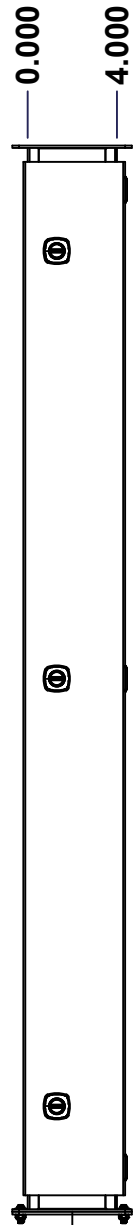

FRONT

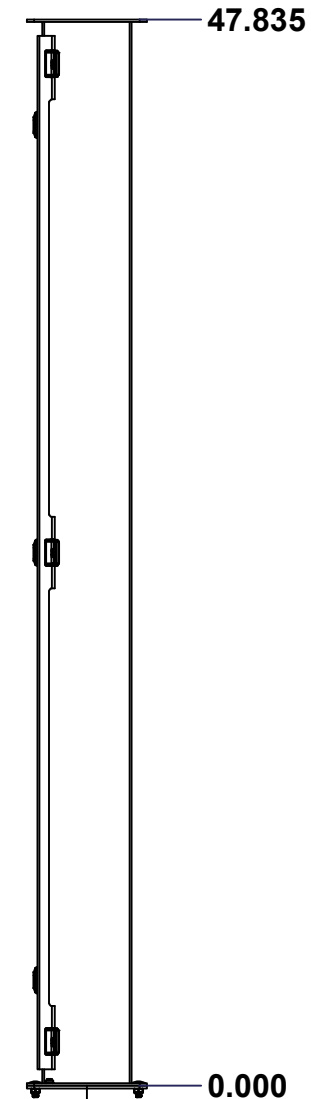

RIGHT

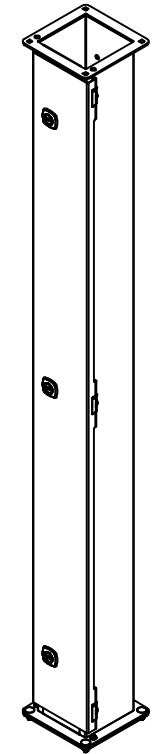

Isometric View

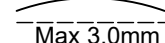
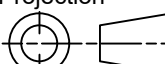

No.	Revisions	Date	By/Par

 Tél: (450) 979-4373 Fax: (450) 979-4626 www.exmweb.com		Flatness Aplatissement  Max 3.0mm Projection 
Customer Client	Date	
Drawn By Dessiné Par	BoxCad: BoxCad	Date 16-Jul-25
Material Matière	16 Ga Cold Rolled A1008 CS Type B (1.4mm)	
Color Couleur	Asa-61 Grey	Finish Fini Smooth
Description	Detail Rev.	
1412SS 48" x 4" x 4" Assembly		
Part Number Numéro Pièce	Rev. 0	1 8

SEE BILL OF MATERIAL ON LAST PAGE

1412SS4048

This drawing is confidential and must not be reproduced or used without the consent of EXM

Ce dessin est confidentiel et ne doit pas être reproduit ou utilisé sans le consentement de EXM

NOTE	
ITEM	DESCRIPTION
1	NEMA 4, 12 Enclosure (IP66)

No.	Revisions	Date	By/Par

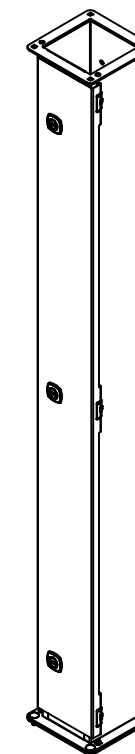

Isometric View



Tél: (450) 979-4373
 Fax: (450) 979-4626
www.exmweb.com

Flatness
Aplatissement

Max 3.0mm

Projection



Customer Client	Date
Drawn By / Dessiné Par: BoxCad: BoxCad	Date: 16-Jul-25
Material / Matière: 16 Ga Cold Rolled A1008 CS Type B (1.4mm)	

Color / Couleur: Asa-61 Grey	Finish / Fini: Smooth
------------------------------	-----------------------

Description: 1412SS 48" x 4" x 4" Assembly	Detail Rev.
--	-------------

Part Number / Numéro Pièce: 1412SS4048	Rev. 0	2 / 8
---	---------------	-------

Qty	Part Number	Rev	Description
4	STK-Q-00266	0	M6 x 16mm Stainless Steel 316 Carriage Bolt
1	STK-G-01610	1	1412 Pull Through Wireway Gasket
1	1412SS4048C	0	1412SS 48" x 4" Cover
1	1412SS4048B	0	1412SS 48" x 4" x 4" Body
3	STK-A-08126	0	M5 Stainless Steel 316 Nylon Insert Lock Nut with Incorporated Sealing Washer
4	STK-Q-07225	0	M6 Stainless Steel Nylon Insert Lock Nut

Qty	Part Number	Rev	Description
Parts List			

PACKING		
ITEM	QTY	DESCRIPTION
Cardboard sleeve	2	Top and Bottom
Plastic strap - Black	2	To Squeeze 2 cardboard sleeve together
Packaging label	3	White label with PN

This drawing is confidential and must not be reproduced or used without the consent of EXM

Ce dessin est confidentiel et ne doit pas être reproduit ou utilisé sans le consentement de EXM

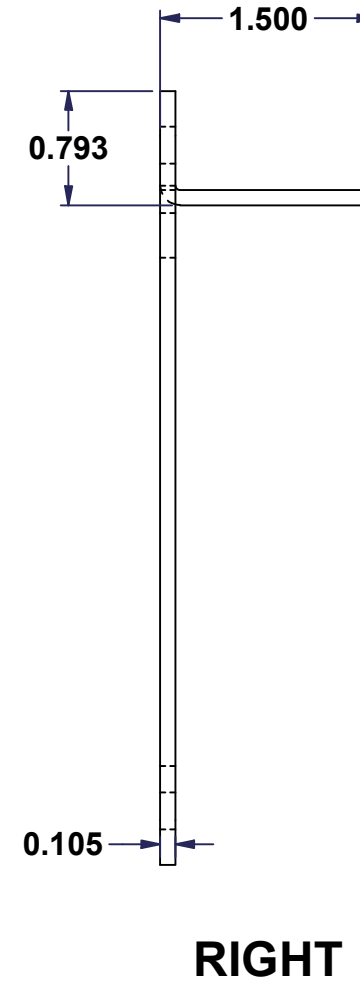
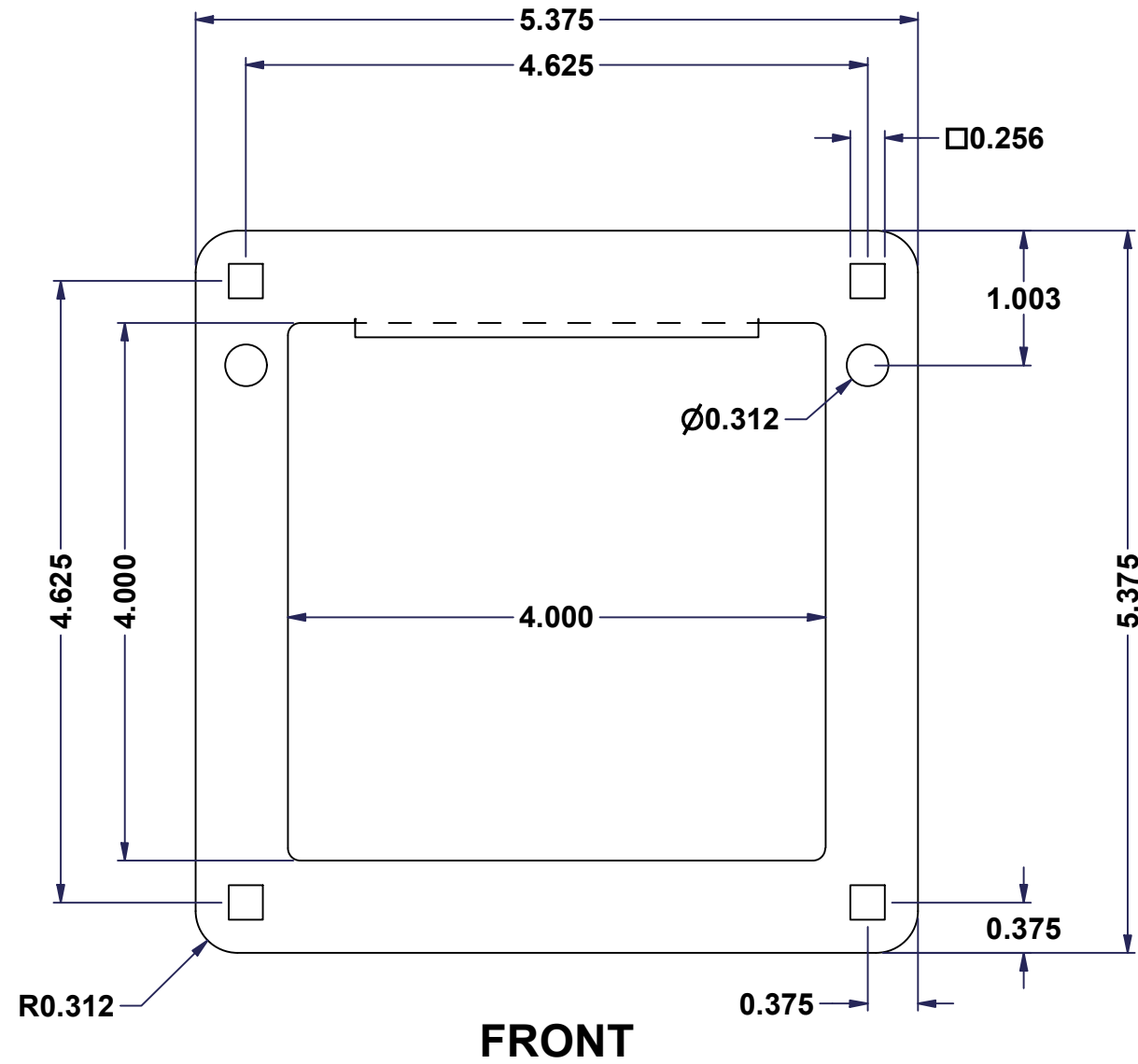

No.	Revisions	Date	By/Par

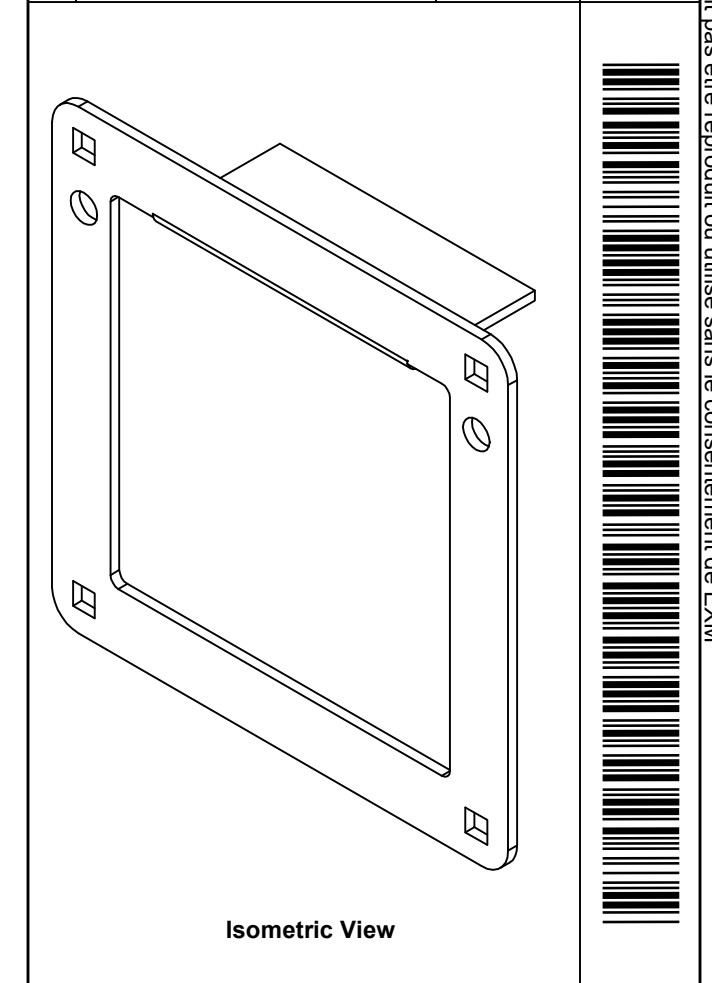

Tél: (450) 979-4373 Fax: (450) 979-4626 www.exmweb.com		Flatness Aplatissement Max 3.0mm Projection
Customer Client		Date
Drawn By Dessiné Par	BoxCad: BoxCad	Date 16-Jul-25
Material Matière	12 Ga Cold Rolled A1008 CS Type B (2.5mm)	
Color Couleur	Asa-61 Grey	Finish Fini Smooth
Description		Detail Rev.
1412SS4" x 4" Connector Part		
Part Number Numéro Pièce	1412SS4048BC-P	Rev. 3
	0	8

This drawing is confidential and must not be reproduced or used without the consent of EXM

Ce dessin est confidentiel et ne doit pas être reproduit ou utilisé sans le consentement de EXM

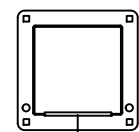
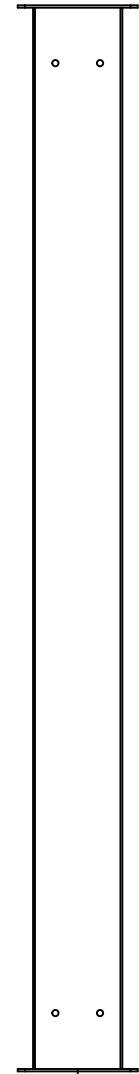
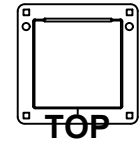

TOP

BACK

BOTTOM

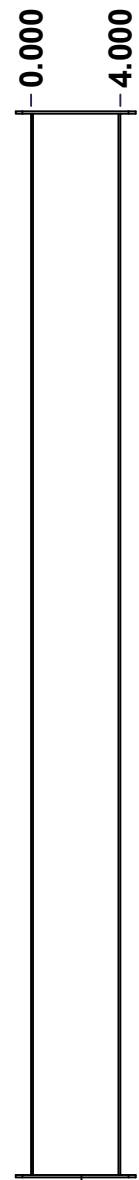

LEFT

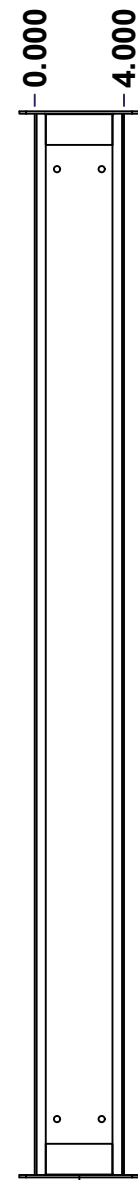

FRONT

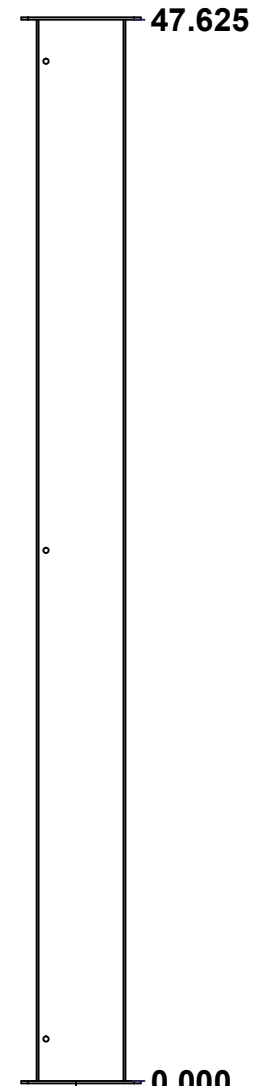

RIGHT

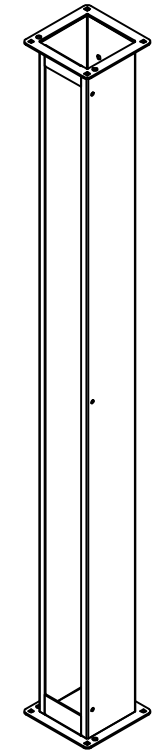

Isometric View

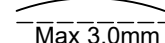

No.	Revisions	Date	By/Par

 Tél: (450) 979-4373 Fax: (450) 979-4626 www.exmweb.com		Flatness Aplatissement  Max 3.0mm
Customer Client		Date
Drawn By Dessiné Par BoxCad: BoxCad		Date 16-Jul-25
Material Matière 16 Ga Cold Rolled A1008 CS Type B (1.4mm)		
Color Couleur Asa-61 Grey	Finish Fini Smooth	
Description 1412SS 48" x 4" x 4" Body		Detail Rev.
Part Number Numéro Pièce 1412SS4048B		Rev. 4 0

SEE BILL OF MATERIAL ON LAST PAGE

This drawing is confidential and must not be reproduced or used without the consent of EXM

Ce dessin est confidentiel et ne doit pas être reproduit ou utilisé sans le consentement de EXM

No.	Revisions	Date	By/Par

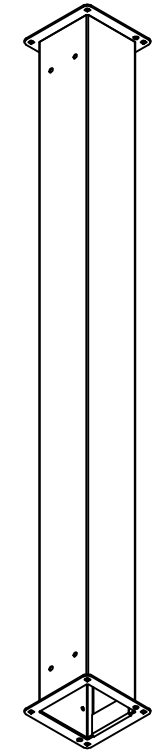

Isometric View

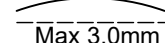

 Tél: (450) 979-4373 Fax: (450) 979-4626 www.exmweb.com		Flatness Aplatissement  Max 3.0mm
Customer Client		Date
Drawn By Dessiné Par BoxCad: BoxCad		Date 16-Jul-25
Material Matière 16 Ga Cold Rolled A1008 CS Type B (1.4mm)		
Color Couleur Asa-61 Grey	Finish Fini Smooth	
Description 1412SS 48" x 4" x 4" Body		Detail Rev.
Part Number Numéro Pièce 1412SS4048B		Rev. 0 / 5

Qty	Part Number	Rev	Description
1	STK-P-02400S	0	Powder Paint (Asa-61 Grey / Smooth)
2	1412SS4048BC-P	0	1412SS4" x 4" Connector Part
1	1412SS4048B-P	0	1412SS 48" x 4" x 4" Body Part
Parts List			

This drawing is confidential and must not be reproduced or used without the consent of EXM

Ce dessin est confidentiel et ne doit pas être reproduit ou utilisé sans le consentement de EXM

TOP

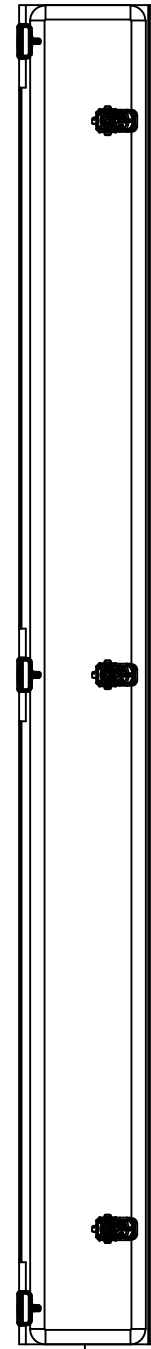

BACK

BOTTOM

0.000
0.660

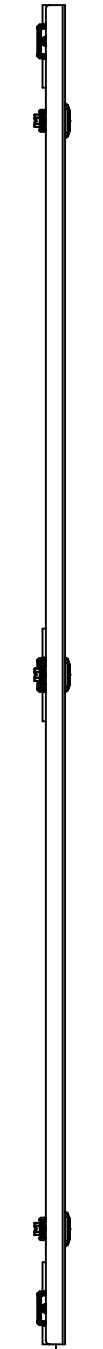

LEFT

0.000
4.565

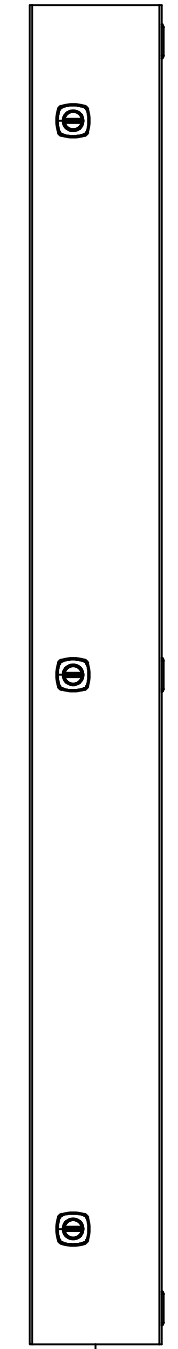

FRONT

46.375

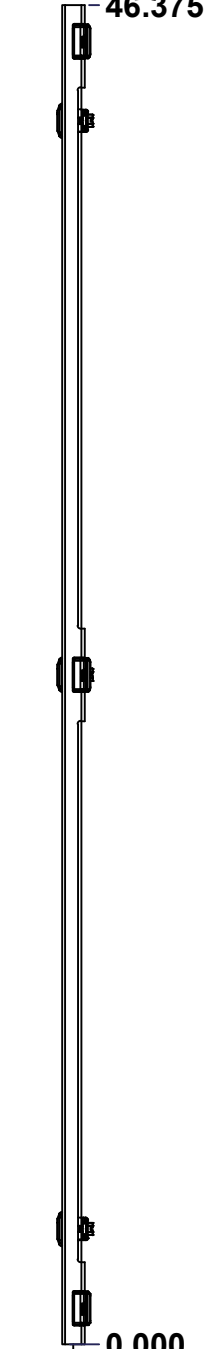

RIGHT



Isometric View

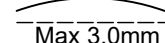
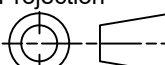

No.	Revisions	Date	By/Par

 Tél: (450) 979-4373 Fax: (450) 979-4626 www.exmweb.com		Flatness Aplatissement  Max 3.0mm Projection 
Customer Client	Date	
Drawn By Dessiné Par	BoxCad: BoxCad	Date 16-Jul-25
Material Matière	16 Ga Cold Rolled A1008 CS Type B (1.4mm)	
Color Couleur	Asa-61 Grey	Finish Fini Smooth
Description	Detail Rev.	
1412SS 48" x 4" Cover		
Part Number Numéro Pièce	Rev.	6
1412SS4048C	0	8

SEE BILL OF MATERIAL ON LAST PAGE

This drawing is confidential and must not be reproduced or used without the consent of EXM

Ce dessin est confidentiel et ne doit pas être reproduit ou utilisé sans le consentement de EXM

STANDARD FEATURES ARE NOT LISTED IN THIS HOLE TABLE			
HOLE TABLE - FRONT VIEW (CUSTOM FEATURE ONLY)			
CUT-OUT	XDIM	YDIM	DESCRIPTION
1	3.065	42.375	LOCK 880 SCQ4CH-SL @ 180.0°
2	3.065	23.188	LOCK 880 SCQ4CH-SL @ 180.0°
3	3.065	4.000	LOCK 880 SCQ4CH-SL @ 180.0°

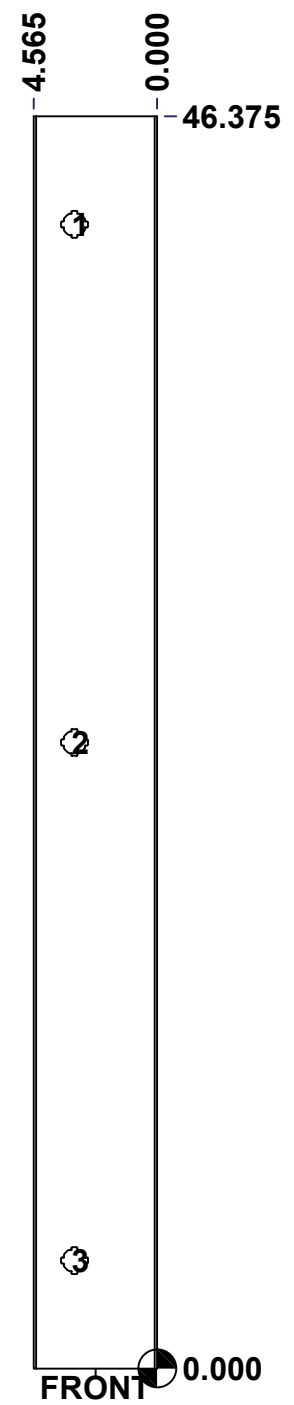

	Description	Status	
	1412SS 48" x 4" x 4" Cover	(NULL)	
	Part Number Numéro Pièce	Rev.	
	1412SS4048C	0	7 8

This drawing is confidential and must not be reproduced or used without the consent of EXM

Ce dessin est confidentiel et ne doit pas être reproduit ou utilisé sans le consentement de EXM

No.	Revisions	Date	By/Par

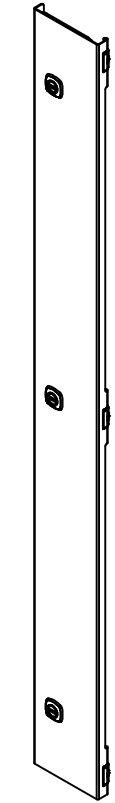

Isometric View

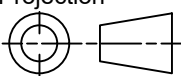

 Tél: (450) 979-4373 Fax: (450) 979-4626 www.exmweb.com		Flatness Aplatissement Max 3.0mm Projection 
Customer Client	Date	
Drawn By Dessiné Par	BoxCad: BoxCad	Date 16-Jul-25
Material Matière	16 Ga Cold Rolled A1008 CS Type B (1.4mm)	
Color Couleur	Asa-61 Grey	Finish Fini Smooth
Description		Detail Rev.
1412SS 48" x 4" Cover		
Part Number Numéro Pièce	Rev.	8
1412SS4048C	0	8

Qty	Part Number	Rev	Description
1	1412SS4048G	0	1412SS 48" x 4" Cover Gasket Part
1	STK-P-02400S	0	Powder Paint (Asa-61 Grey / Smooth)
1	1412SS4048C-P	0	1412SS 48" x 4" x 4" Cover Part
3	STK-A-33033	4	5412 ESMCH Hinge
3	880 SCQ4CH-SL	0	5412 CH 1/4 Turn Lock
Parts List			