

This drawing is confidential and must not be reproduced or used without the consent of EXM

Ce dessin est confidentiel et ne doit pas être reproduit ou utilisé sans le consentement de EXM

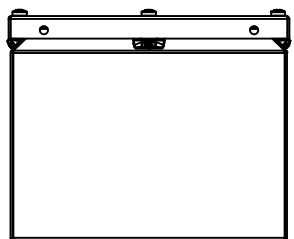

TOP

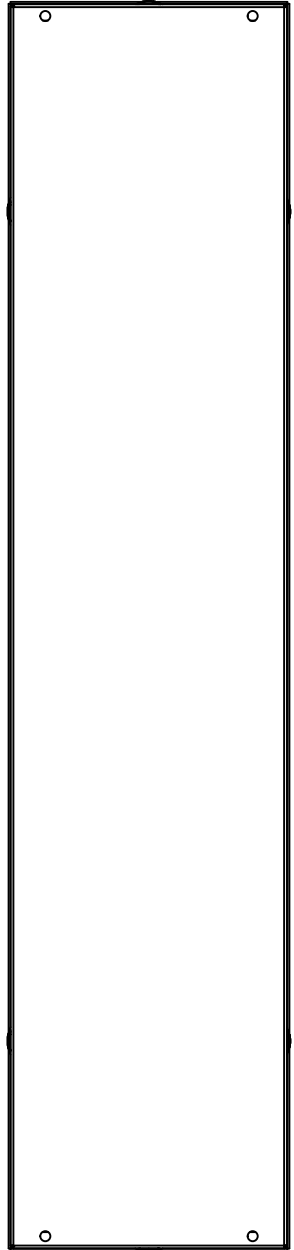

BACK

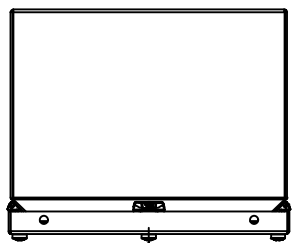

BOTTOM

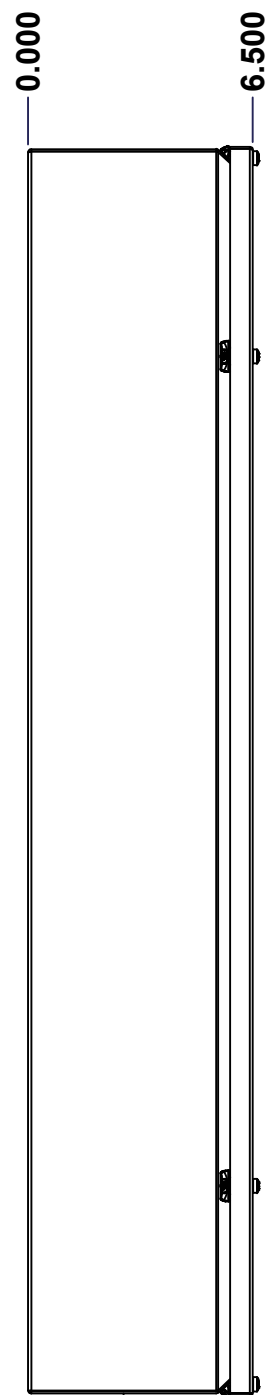

LEFT

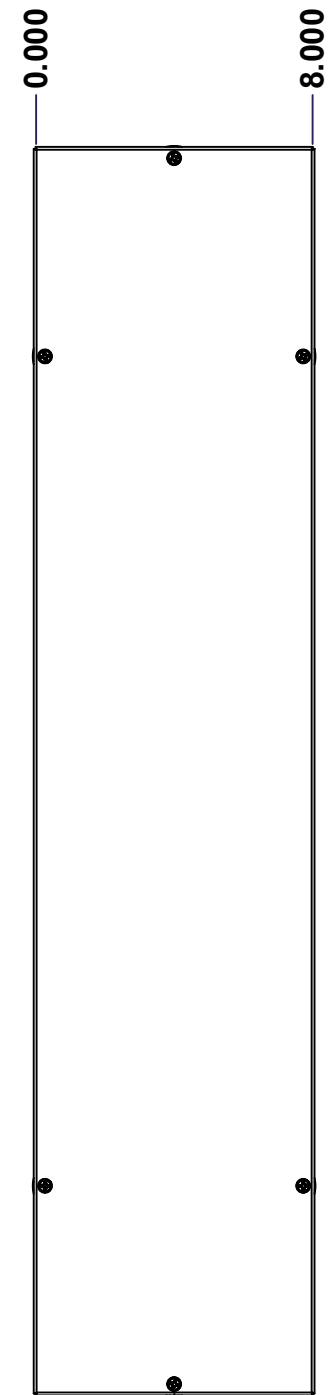

FRONT

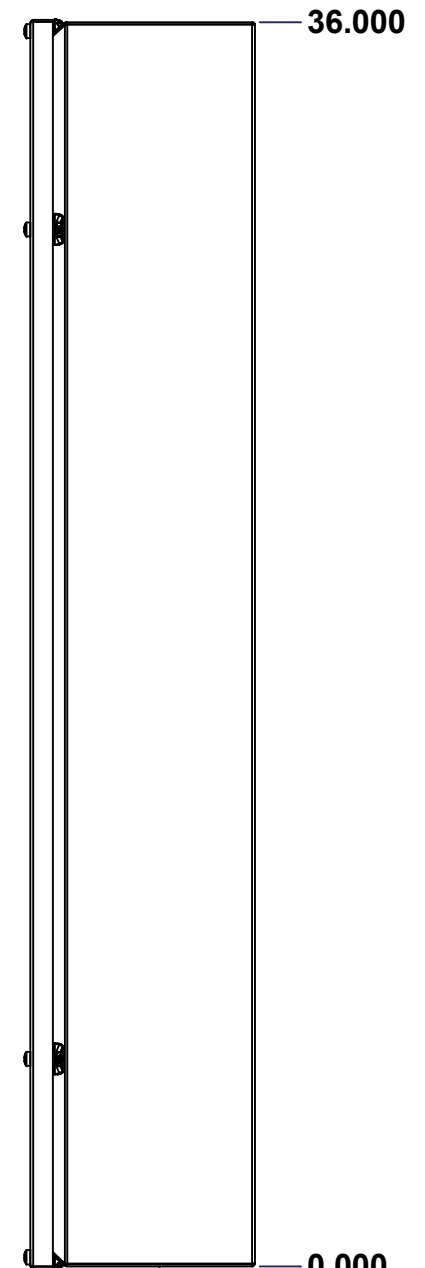

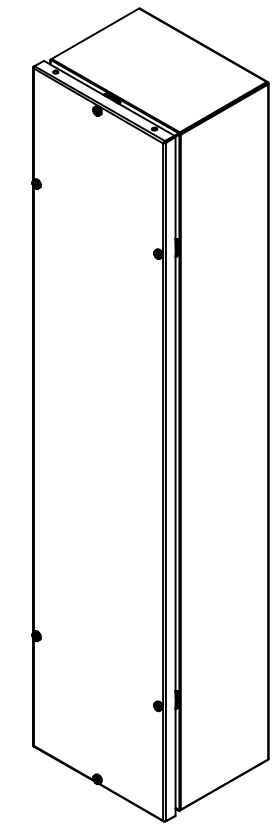
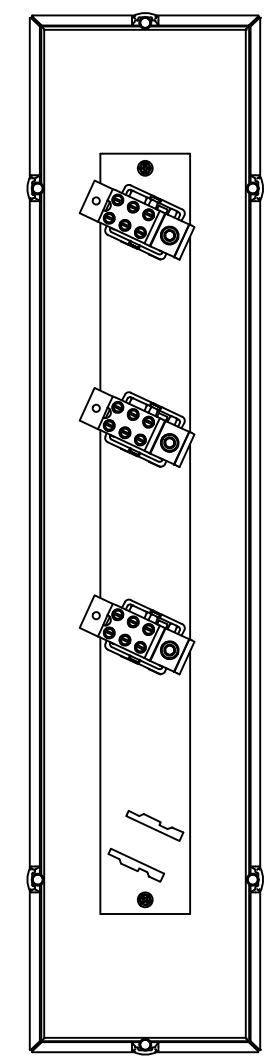

RIGHT

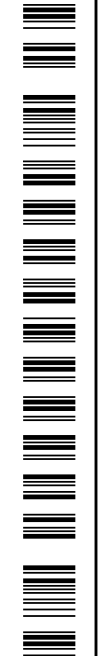

Isometric View

| No. | Revisions | Date | By/Par |
|-----|-----------|------|--------|
| | | | |
| | | | |
| | | | |
| | | | |

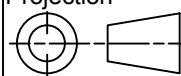

| | | |
|--|---------------------------|---|
|  Tél: (450) 979-4373 Fax: (450) 979-4626 www.exmweb.com | | Flatness Aplatissement Max 3.0mm Projection  |
| Customer Client | | Date |
| Drawn By Dessiné Par | BoxCad: m_altork | Date 16/02/2015 |
| Material Matière | 16 Ga H.R.P. & O. (1.4mm) | |
| Color Couleur | ASA-61 | Finish Fini Smooth |
| Description 1400T3203 - 3 Wire Assembly | | Detail Rev. |
| Part Number Numéro Pièce | 1400T3203 | Rev. 1 0 |

This drawing is confidential and must not be reproduced or used without the consent of EXM

Ce dessin est confidentiel et ne doit pas être reproduit ou utilisé sans le consentement de EXM

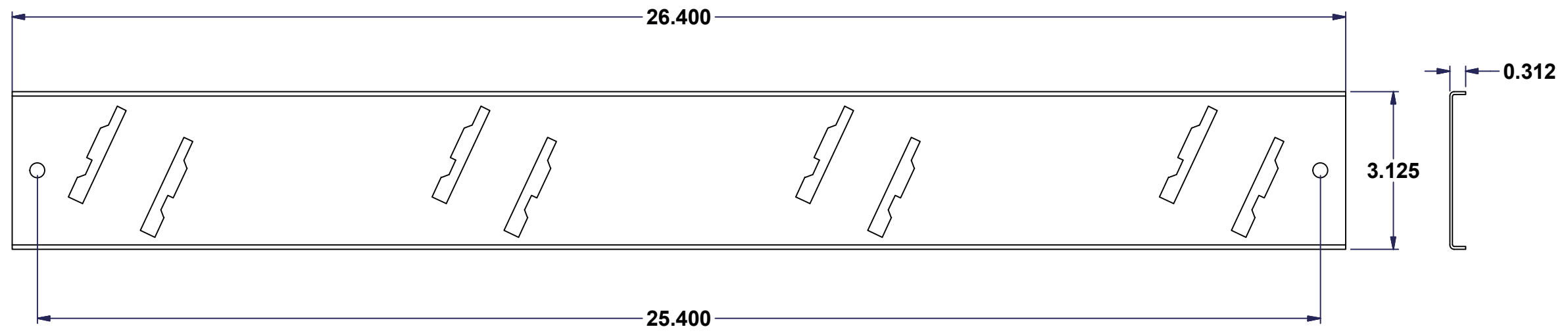

| No. | Revisions | Date | By/Par |
|-----|-----------------------|-----------|---------|
| 1 | Cut-out was rectangle | 10-Jan-07 | Patrick |
| 2 | Change cut-out angle | 17-Jan-07 | Patrick |
| | | | |
| | | | |
| | | | |

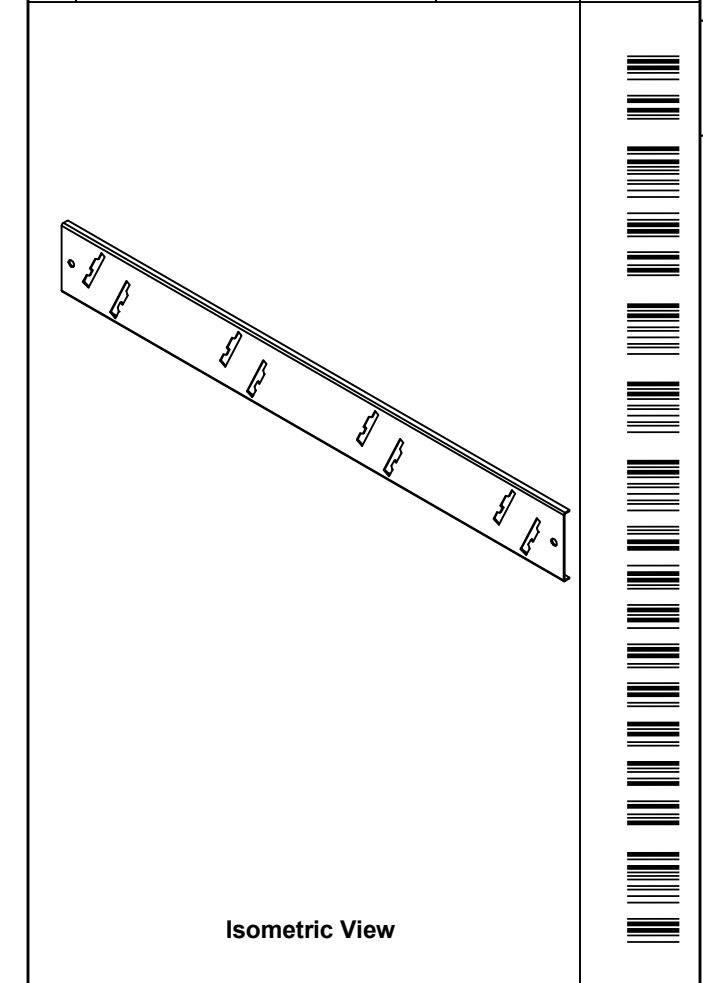

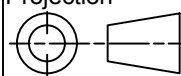
| | | |
|--|---------------------------|---|
|  Tél: (450) 979-4373 Fax: (450) 979-4626 www.exmweb.com | | Flatness Aplatissement Max 3.0mm Projection  |
| Customer Client | Date | |
| Drawn By Dessiné Par | BoxCad: Patrick Deschenes | Date |
| Material Matière | 16 Ga H.R.P. & O. (1.4mm) | |
| Color Couleur | Asa-61 Grey | Finish Fini Smooth |
| Description 1400 T3xxxIP - Inner Panel | | Detail Rev. |
| Part Number Numéro Pièce | 1400 T3xxxIP | Rev. 2 2 |