

This drawing is confidential and must not be reproduced or used without the consent of EXM

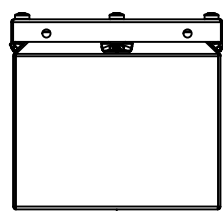

TOP

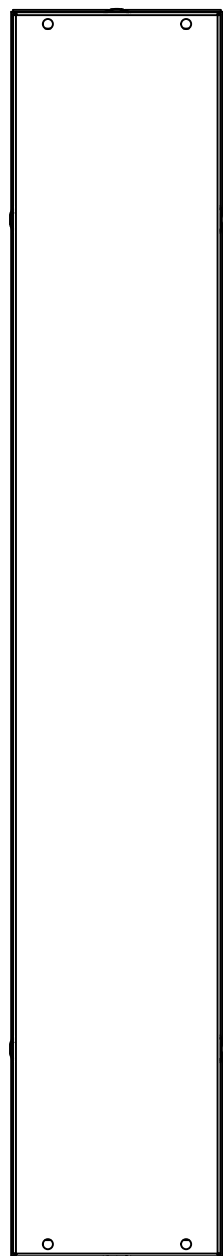

BACK

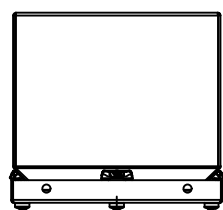

BOTTOM

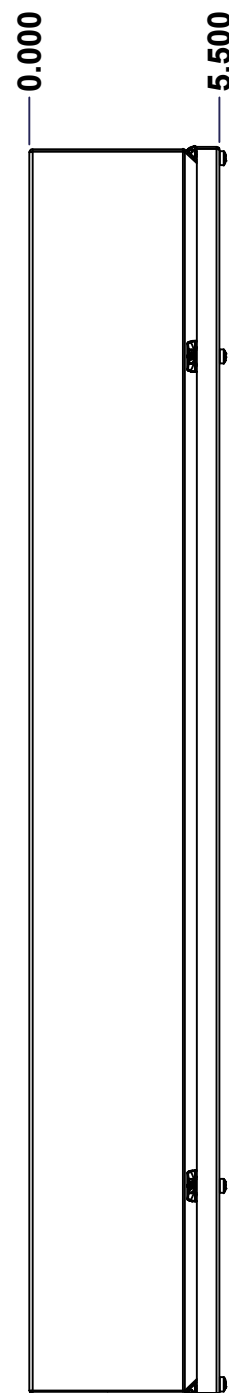

LEFT

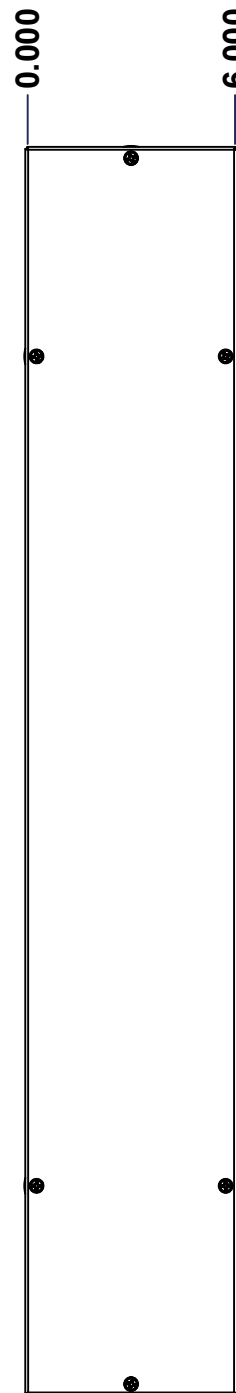

FRONT

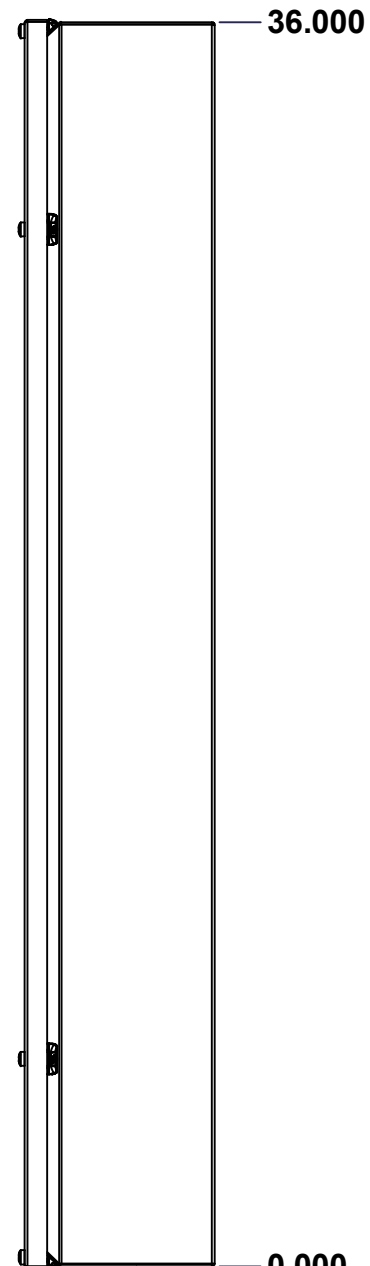

RIGHT

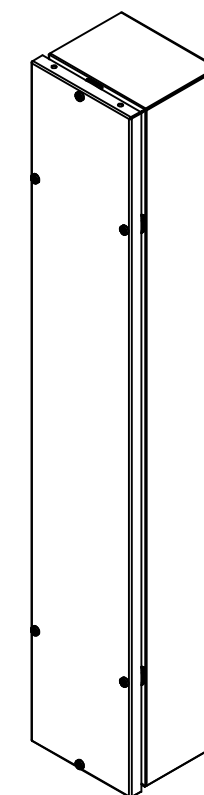
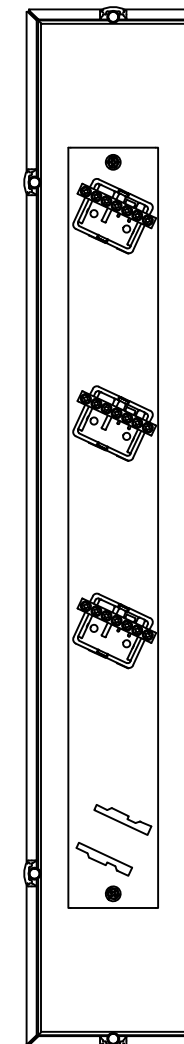

Isometric View

No.	Revisions	Date	By/Par



Ce dessin est confidentiel et ne doit pas être reproduit ou utilisé sans le consentement de EXM

	Tél: (450) 979-4373 Fax: (450) 979-4626 <a href="http://www.exmweb.com">www.exmweb.com</a>	Flatness Aplatissement Max 3.0mm Projection 		
	Customer Client	Date		
Drawn By Dessiné Par	BoxCad: m_altork	Date 16/02/2015		
Material Matière	16 Ga H.R.P. & O. (1.4mm)			
Color Couleur	ASA-61	Finish Fini Smooth		
Description 1400T373 - 3 Wire Assembly	Detail Rev.			
Part Number Numéro Pièce <b>1400T373</b>	Rev.	<table border="1"> <tr> <td>1</td> </tr> <tr> <td>2</td> </tr> </table>	1	2
1				
2				

This drawing is confidential and must not be reproduced or used without the consent of EXM

Ce dessin est confidentiel et ne doit pas être reproduit ou utilisé sans le consentement de EXM

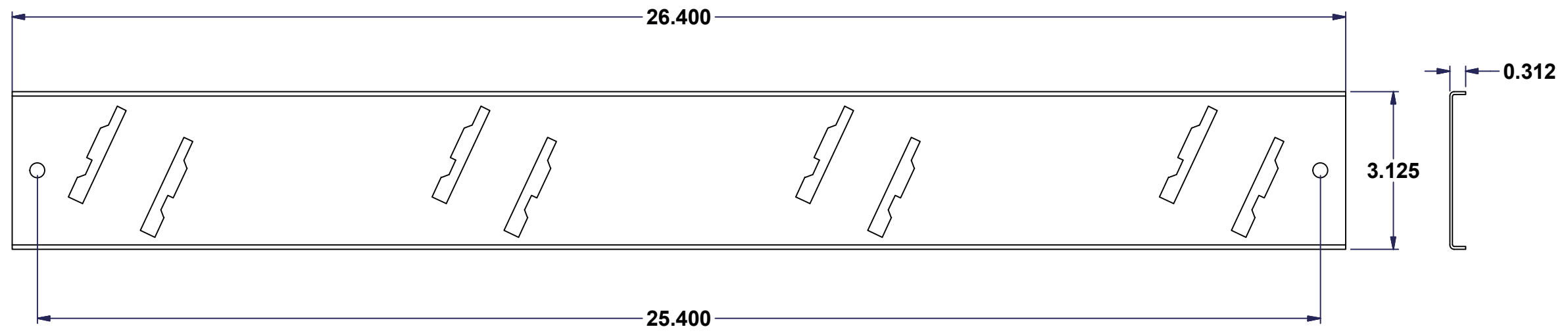

No.	Revisions	Date	By/Par
1	Cut-out was rectangle	10-Jan-07	Patrick
2	Change cut-out angle	17-Jan-07	Patrick

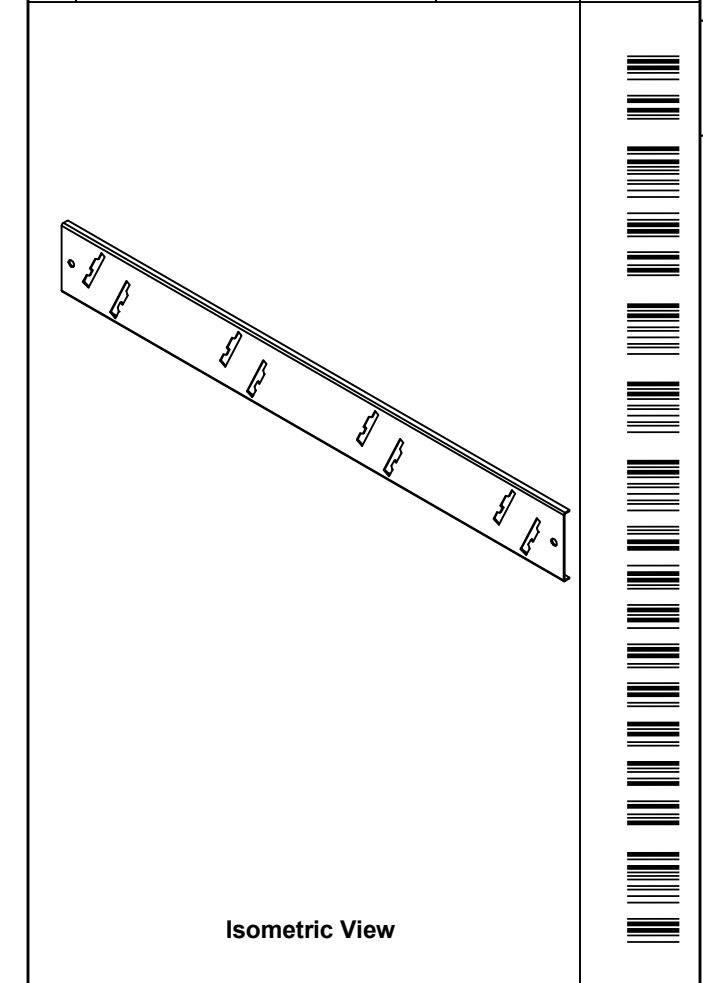

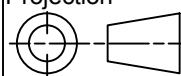
 Tél: (450) 979-4373 Fax: (450) 979-4626 <a href="http://www.exmweb.com">www.exmweb.com</a>		Flatness Aplatissement Max 3.0mm	
		Projection 	
Customer Client	Date		
Drawn By Dessiné Par	BoxCad: Patrick Deschenes	Date	
Material Matière	16 Ga H.R.P. & O. (1.4mm)		
Color Couleur	Asa-61 Grey	Finish Fini	Smooth
Description		Detail Rev.	
1400 T3xxxIP - Inner Panel			
Part Number Numéro Pièce	<b>1400 T3xxxIP</b>	Rev.	2
		<b>2</b>	2