

This drawing is confidential and must not be reproduced or used without the consent of EXM

Ce dessin est confidentiel et ne doit pas être reproduit ou utilisé sans le consentement de EXM

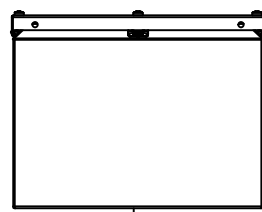

TOP

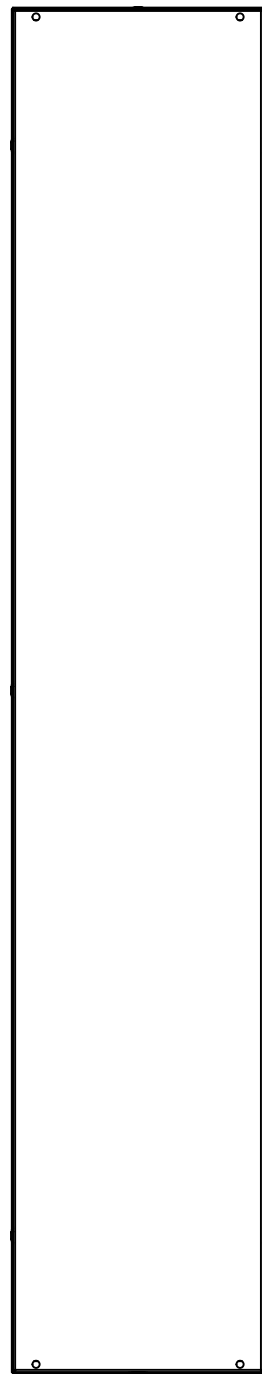

BACK

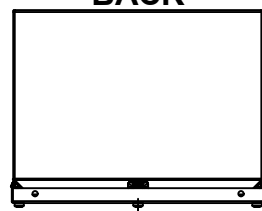

BOTTOM

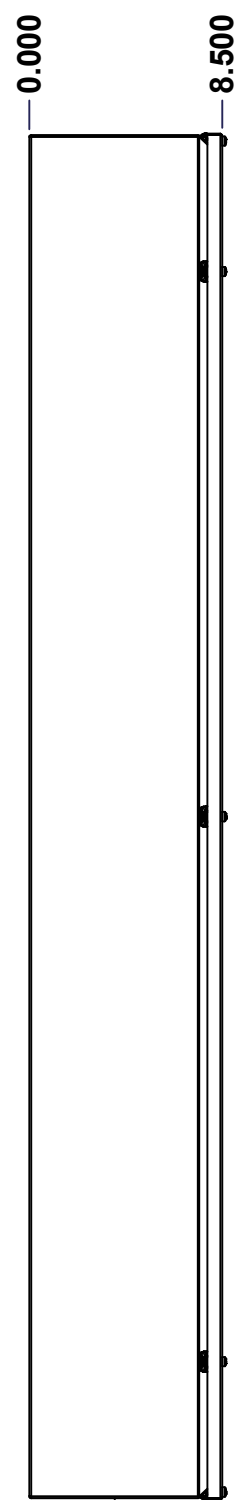

LEFT

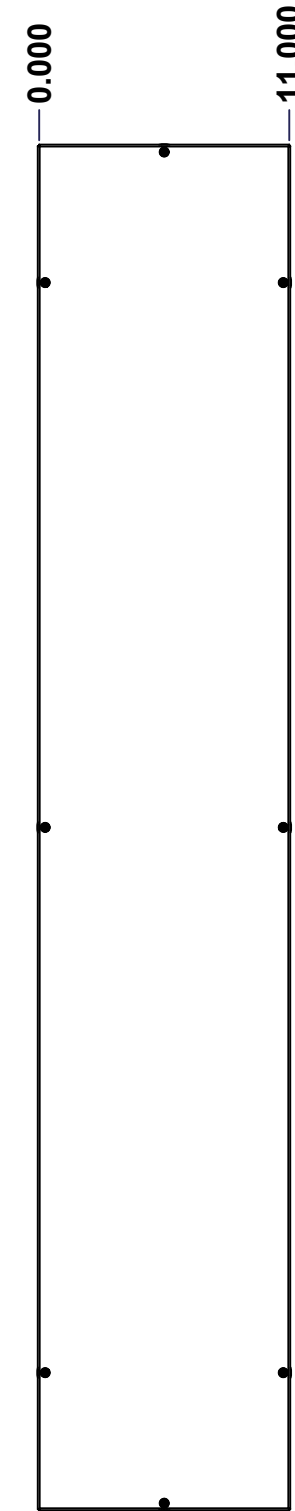

FRONT

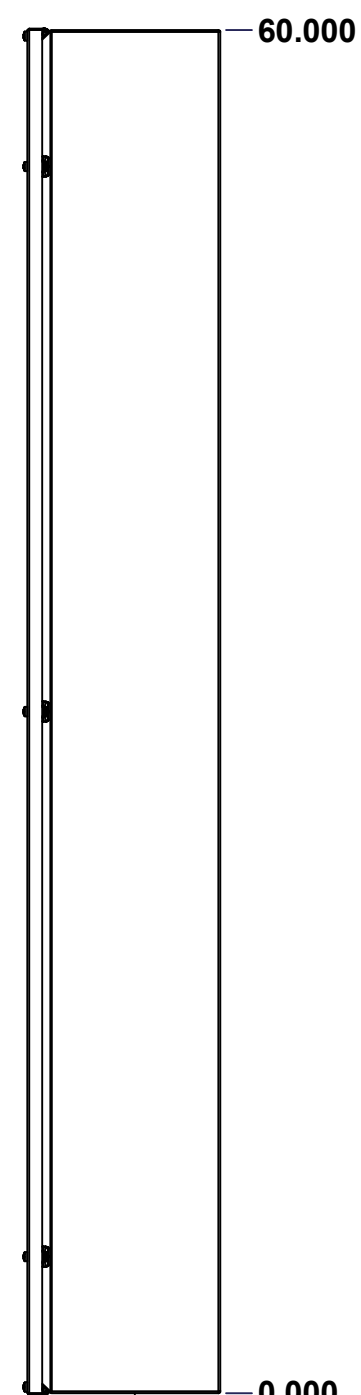

RIGHT

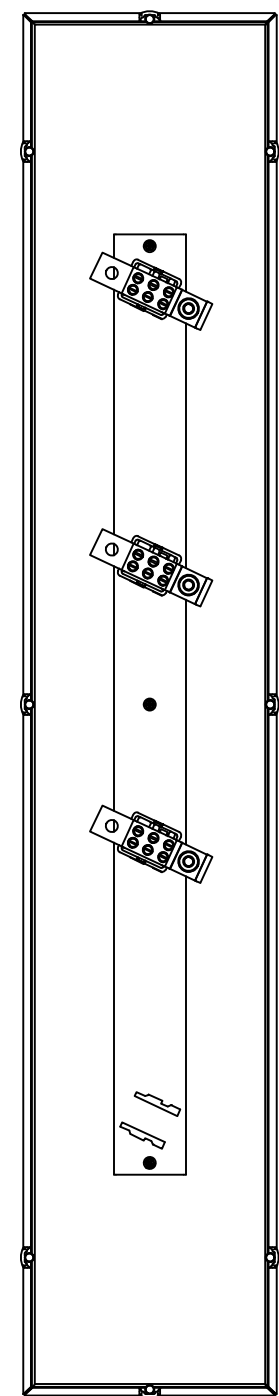

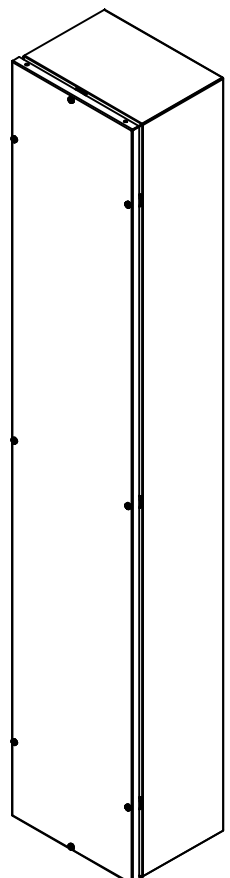

Isometric View

No.	Revisions	Date	By/Par



Isometric View

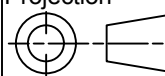

 Tél: (450) 979-4373 Fax: (450) 979-4626 www.exmweb.com		Flatness Aplatissement Max 3.0mm	
		Projection 	
Customer Client		Date	
Drawn By Dessiné Par BoxCad: m_altork		Date 16/02/2015	
Material Matière 16 Ga H.R.P. & O. (1.4mm)			
Color Couleur ASA-61		Finish Fini Smooth	
Description 1400T5403 - 3 Wire Assembly			Detail Rev.
Part Number Numéro Pièce 1400T5403			Rev. 1 0 / 2

This drawing is confidential and must not be reproduced or used without the consent of EXM

Ce dessin est confidentiel et ne doit pas être reproduit ou utilisé sans le consentement de EXM

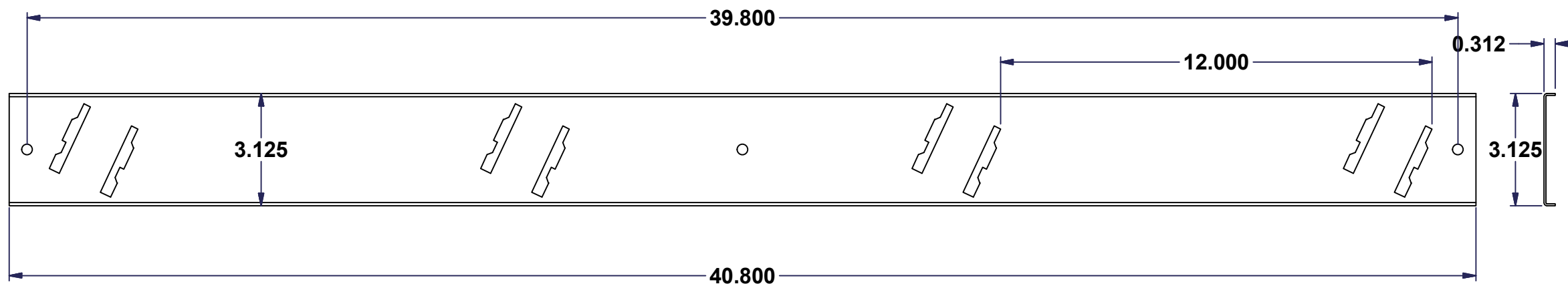

No.	Revisions	Date	By/Par
1	Cut-out was rectangle	10-Jan-07	Patrick
2	Change cut-out angle	17-Jan-07	Patrick

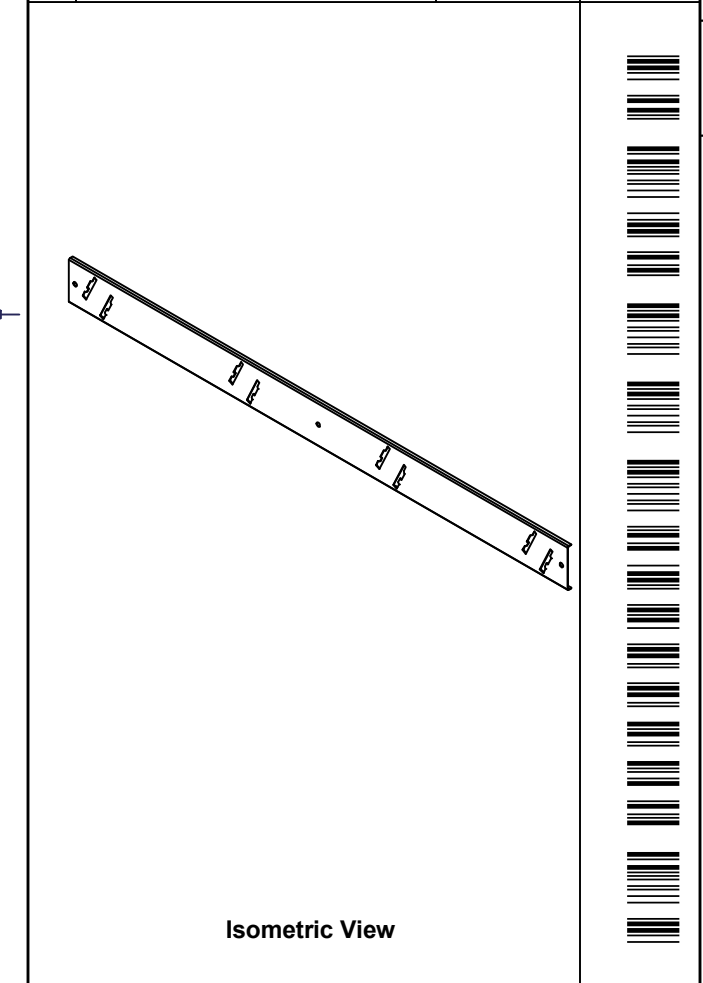

Isometric View

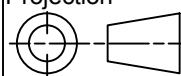
 Tél: (450) 979-4373 Fax: (450) 979-4626 www.exmweb.com		Flatness Aplatissement Max 3.0mm Projection 
Customer Client	Date	
Drawn By Dessiné Par	BoxCad: Patrick Deschenes	Date
Material Matière	16 Ga H.R.P. & O. (1.4mm)	
Color Couleur	Asa-61 Grey	Finish Fini: Smooth
Description 1400T5xxxIP - Inner Panel Part		Detail Rev.
Part Number Numéro Pièce	1400T5xxxIP	Rev. 2 2