

This drawing is confidential and must not be reproduced or used without the consent of EXM

Ce dessin est confidentiel et ne doit pas être reproduit ou utilisé sans le consentement de EXM

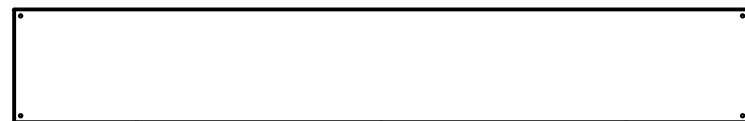

TOP



BACK



BOTTOM

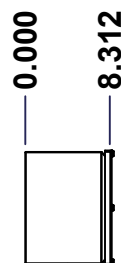

LEFT

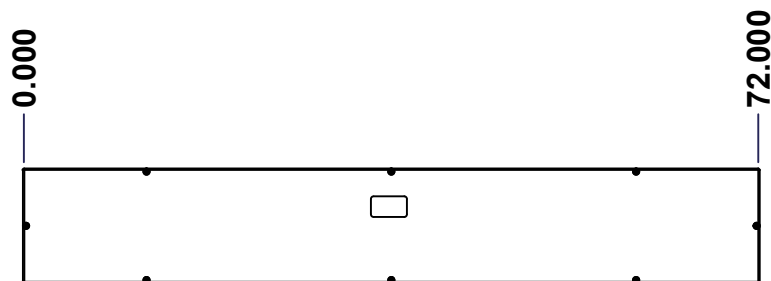

FRONT

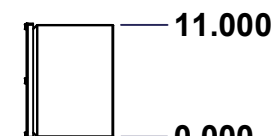

RIGHT

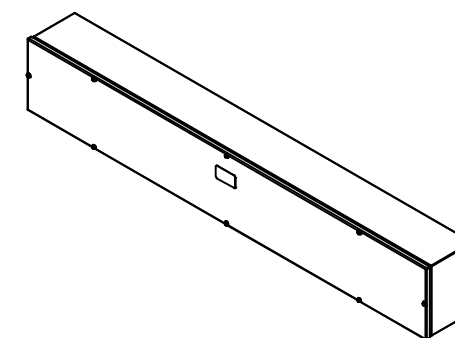

Isometric View



**GRAIN DIRECTION:
TOP/BOTTOM: HORIZONTAL
LEFT/RIGHT/BACK/FRONT: VERTICAL**

SEE BILL OF MATERIAL ON LAST PAGE

No.	Revisions	Date	By/Par

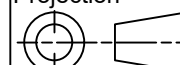
 Tél: (450) 979-4373 Fax: (450) 979-4626 www.exmweb.com		Flatness Aplatissement Max 3.0mm Projection 
Customer Client	Date	
Drawn By Dessiné Par	BoxCad: BoxCad	Date 16-Dec-25
Material Matière	16 Ga Stainless Steel 304 (1.4mm)	
Color Couleur	Unpainted	Finish Fini Brushed
Description	Detail Rev.	
1412TSS 11" x 72" x 8.312" Assembly		
Part Number Numéro Pièce	Rev.	1
1412TSS6603	0	12

This drawing is confidential and must not be reproduced or used without the consent of EXM

Ce dessin est confidentiel et ne doit pas être reproduit ou utilisé sans le consentement de EXM

NOTE	
ITEM	DESCRIPTION
1	NEMA 4X Enclosure (IP66)
2	C/W Standard ground studs on box and cover
3	W/O Standard door stiffener
4	C/W Special inner panel (Sold separately)
5	C/W Standard inner panel mounting studs

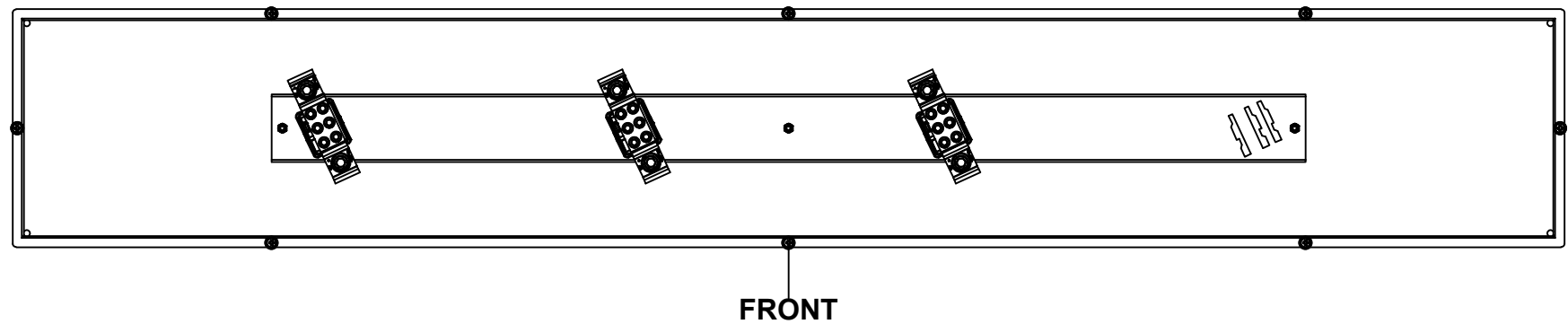

No.	Revisions	Date	By/Par

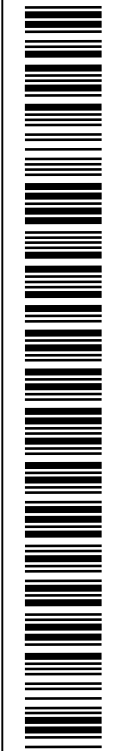
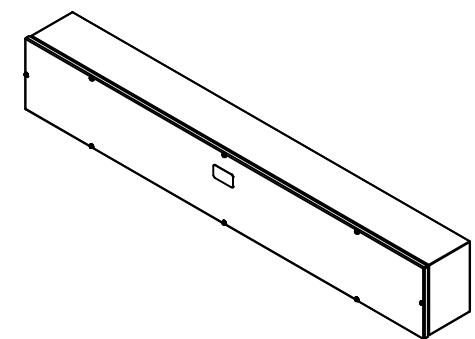

Isometric View



Tél: (450) 979-4373
 Fax: (450) 979-4626
www.exmweb.com

Flatness
Aplatissement
Max 3.0mm
Projection

Customer Client	Date
Drawn By Dessiné Par BoxCad: BoxCad	Date 16-Dec-25
Material Matière 16 Ga Stainless Steel 304 (1.4mm)	

Color Couleur Unpainted	Finish Fini Brushed
----------------------------	------------------------

Description 1412TSS 11" x 72" x 8.312" Assembly	Detail Rev.
--	-------------

Part Number Numéro Pièce 1412TSS6603	Rev. 0	2 12
---	------------------	----------------

PACKING		
ITEM	QTY	DESCRIPTION
Cardboard sleeve	2	Top and Bottom
Cardboard strip	2	Between back of enclosure and inner panel
Plastic bag	1	To protect cover surface and inside gasket
Cardboard corner	4	To reinforced for the plastic strap tightening
Plastic strap - Black	2	To Squeeze the 2 cardboard sleeve together
Packaging label	3	White label with PN
Plastic strap- Green	2	To secure the enclosure to the wood pallet
Wood Pallet	1	2" deeper and 3" larger than enclosure size

Qty	Part Number	Rev	Description
1	1412TSS6603C	0	1412TSS 11" x 72" Cover
1	STK-K-02925	3	5412 ESSSC Accessory Kit
1	1412TSS6603IP	0	1412TSS 11" x 72" Inner Panel
1	1412TSS6603B	0	1412TSS 11" x 72" x 8" Body
3	881 BRC600	7	Aluminum Lug with Insulator (250MCM-2)
3	STK-Q-07220	1	M6 Nylon Insert Lock Nut

Parts List

This drawing is confidential and must not be reproduced or used without the consent of EXM

Ce dessin est confidentiel et ne doit pas être reproduit ou utilisé sans le consentement de EXM



TOP

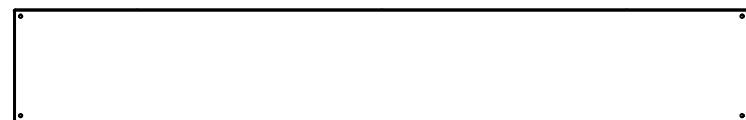

BACK

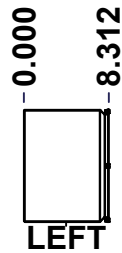

LEFT

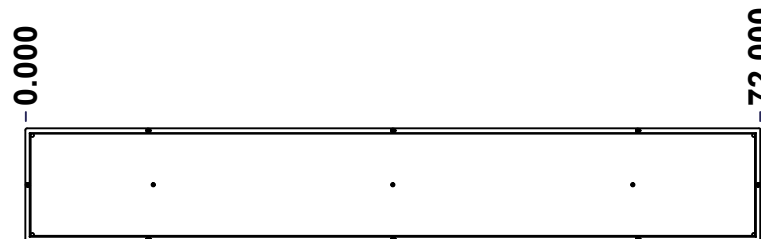

FRONT

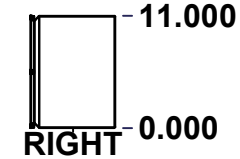

RIGHT

No.	Revisions	Date	By/Par

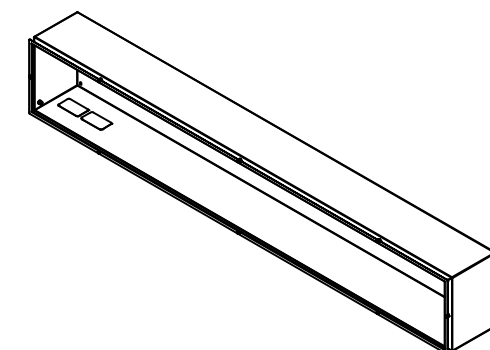

Isometric View

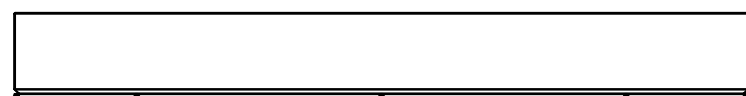

BOTTOM

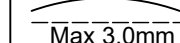
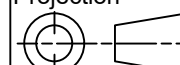
 Tél: (450) 979-4373 Fax: (450) 979-4626 www.exmweb.com		Flatness Aplatissement  Max 3.0mm
Projection 		Date 16-Dec-25
Customer Client	Date	
Drawn By Dessiné Par	BoxCad: BoxCad	Date 16-Dec-25
Material Matière	16 Ga Stainless Steel 304 (1.4mm)	
Color Couleur	Unpainted	Finish Fini Brushed
Description	Detail Rev.	
1412TSS 11" x 72" x 8" Body		
Part Number Numéro Pièce	Rev.	3
1412TSS6603B	0	12

SEE BILL OF MATERIAL ON LAST PAGE

This drawing is confidential and must not be reproduced or used without the consent of EXM

Ce dessin est confidentiel et ne doit pas être reproduit ou utilisé sans le consentement de EXM

STANDARD FEATURES ARE NOT LISTED IN THIS HOLE TABLE			
HOLE TABLE - BOTTOM VIEW (CUSTOM FEATURE ONLY)			
CUT-OUT	XDIM	YDIM	DESCRIPTION
1	7.000	3.700	LABEL_EXM (Inside)
2	3.000	3.700	LABEL_EXM (Inside)

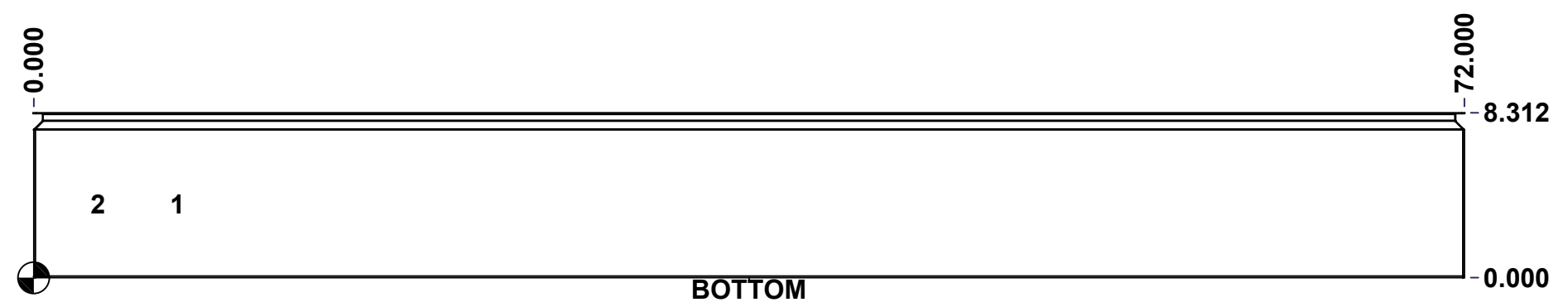

	Description	Status	
	1412TSS 11" x 72" x 8" Body	(NULL)	
	Part Number Numéro Pièce	Rev.	4
	1412TSS6603B	0	12

This drawing is confidential and must not be reproduced or used without the consent of EXM

Ce dessin est confidentiel et ne doit pas être reproduit ou utilisé sans le consentement de EXM

STANDARD FEATURES ARE NOT LISTED IN THIS HOLE TABLE			
HOLE TABLE - LEFT VIEW (CUSTOM FEATURE ONLY)			
CUT-OUT	XDIM	YDIM	DESCRIPTION
1	6.625	0.875	STANDOFF M6 x 10mm (Inside)

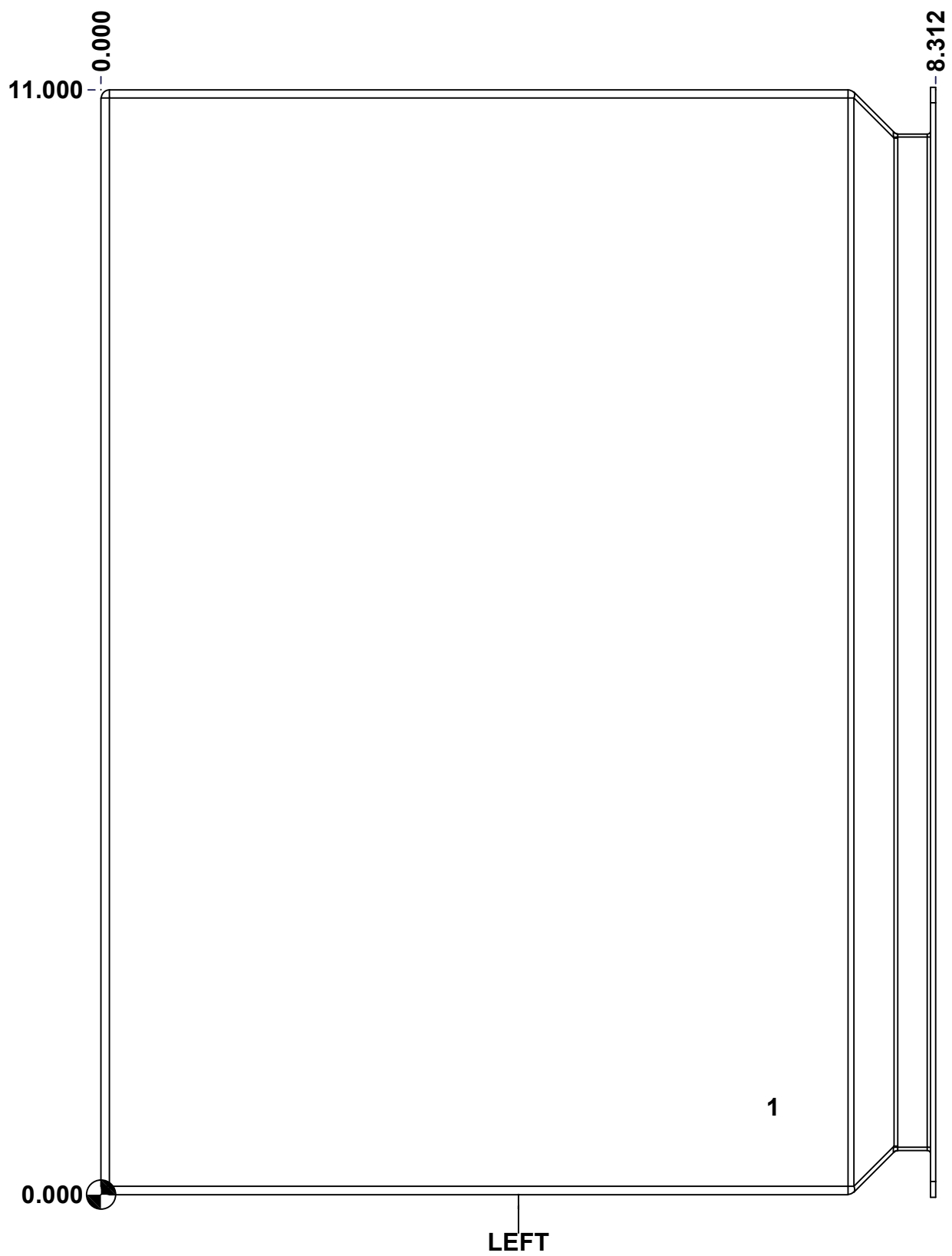

	Description	Status
	1412TSS 11" x 72" x 8" Body	(NULL)
Part Number Numéro Pièce	1412TSS6603B	Rev.
		5
		12

This drawing is confidential and must not be reproduced or used without the consent of EXM

Ce dessin est confidentiel et ne doit pas être reproduit ou utilisé sans le consentement de EXM

STANDARD FEATURES ARE NOT LISTED IN THIS HOLE TABLE			
HOLE TABLE - BACK VIEW (CUSTOM FEATURE ONLY)			
CUT-OUT	XDIM	YDIM	DESCRIPTION
1	12.500	5.500	IP STUD M6 x 18mm (Inside)
2	59.500	5.500	IP STUD M6 x 18mm (Inside)
3	36.000	5.500	IP STUD M6 x 18mm (Inside)

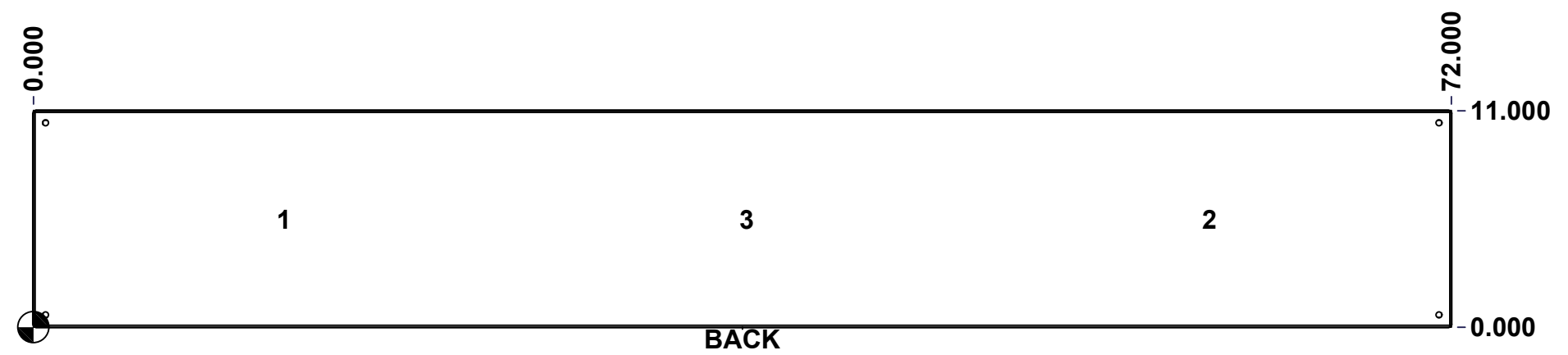

	Description	Status
	1412TSS 11" x 72" x 8" Body	(NULL)
	Part Number Numéro Pièce	Rev.
	1412TSS6603B	0 / 6
		12

This drawing is confidential and must not be reproduced or used without the consent of EXM

Ce dessin est confidentiel et ne doit pas être reproduit ou utilisé sans le consentement de EXM

No.	Revisions	Date	By/Par

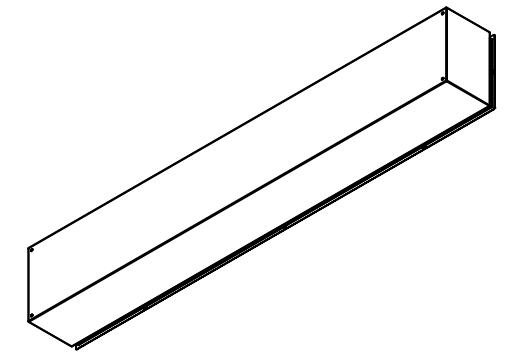

Isometric View



Tél: (450) 979-4373
 Fax: (450) 979-4626
www.exmweb.com

Flatness
Aplatissement
Max 3.0mm
Projection

Customer Client	Date
Drawn By / Dessiné Par: BoxCad: BoxCad	Date: 16-Dec-25
Material / Matière: 16 Ga Stainless Steel 304 (1.4mm)	

Color / Couleur: Unpainted	Finish / Fini: Brushed
Description: 1412TSS 11" x 72" x 8" Body	
Part Number / Numéro Pièce: 1412TSS6603B	Rev. 0

Qty	Part Number	Rev	Description
1	STK-Q-08500	4	Stainless Steel Standoff M6 x 10mm
3	STK-Q-16070	1	Stud M6 x 18mm Stainless Steel
1	1412TSS6603B-P	0	1412TSS 11" x 72" x 8" Body Part
2	STK-S-00100	0	3.5" x 2" Silver Milar Flexcon Sticker
8	RIVET_NUT_SS_M5_FH_OE	0	Stainless Steel Rivet Nut M5 (Low Profile Open End)
Parts List			

This drawing is confidential and must not be reproduced or used without the consent of EXM

Ce dessin est confidentiel et ne doit pas être reproduit ou utilisé sans le consentement de EXM

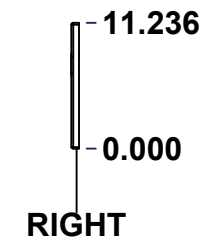
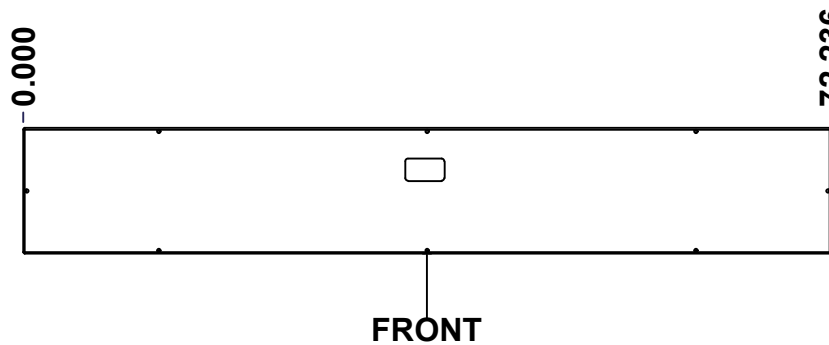
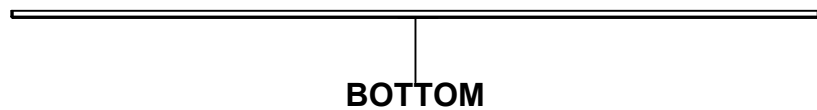
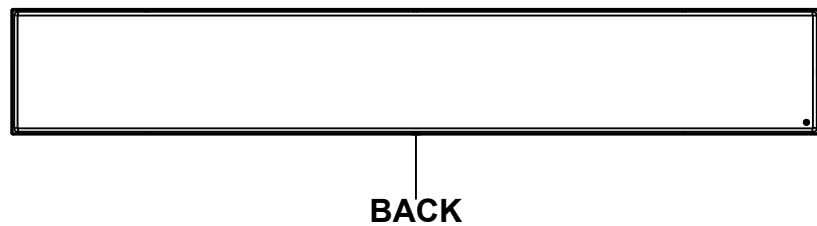
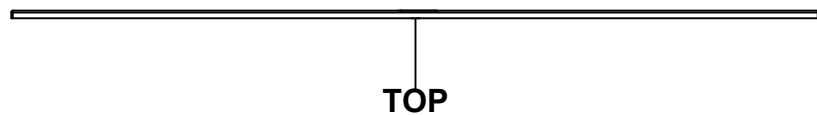

No.	Revisions	Date	By/Par

Isometric View

Tél: (450) 979-4373 Fax: (450) 979-4626 www.exmweb.com		Flatness Aplatissement
		Max 3.0mm
Customer Client		Date
Drawn By Dessiné Par	BoxCad: BoxCad	Date 16-Dec-25
Material Matière 16 Ga Stainless Steel 304 (1.4mm)		
Color Couleur	Unpainted	Finish Fini Brushed
Description 1412TSS 11" x 72" Cover		Detail Rev.
Part Number Numéro Pièce	1412TSS6603C	Rev. 8
SEE BILL OF MATERIAL ON LAST PAGE		0 / 12

This drawing is confidential and must not be reproduced or used without the consent of EXM

Ce dessin est confidentiel et ne doit pas être reproduit ou utilisé sans le consentement de EXM

STANDARD FEATURES ARE NOT LISTED IN THIS HOLE TABLE			
HOLE TABLE - FRONT VIEW (CUSTOM FEATURE ONLY)			
CUT-OUT	XDIM	YDIM	DESCRIPTION
1	35.900	7.500	LABEL_EXM (Outside)
2	1.145	1.125	STANDOFF M6 x 10mm (Inside)

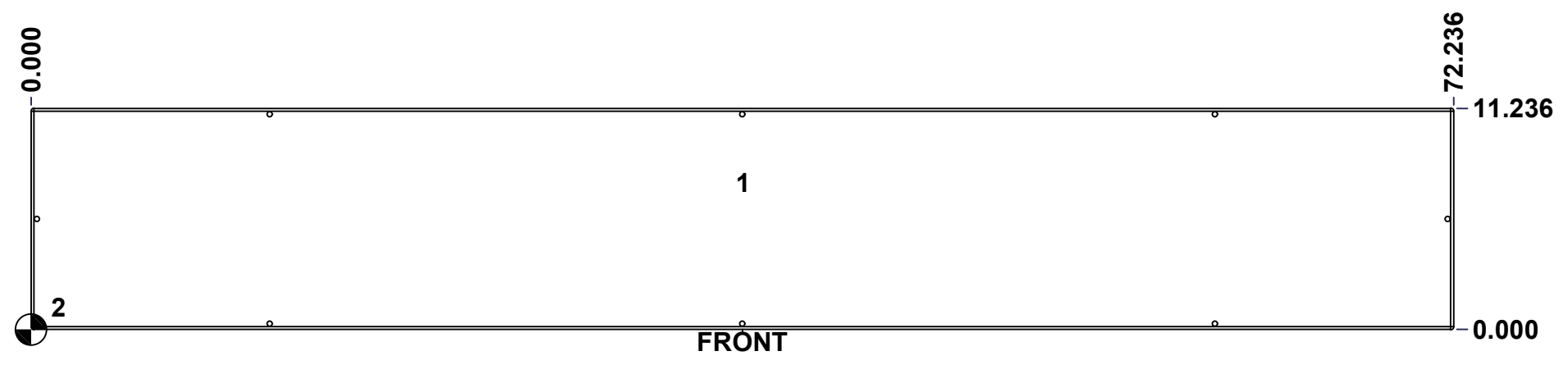

	Description	Status	
	1412TSS 11" x 72" Cover	(NULL)	
	Part Number Numéro Pièce	Rev.	9
	1412TSS6603C	0	12

This drawing is confidential and must not be reproduced or used without the consent of EXM

Ce dessin est confidentiel et ne doit pas être reproduit ou utilisé sans le consentement de EXM

No.	Revisions	Date	By/Par

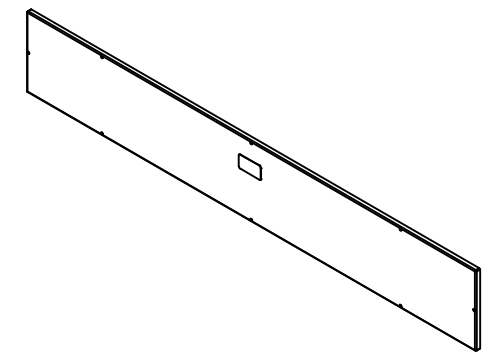

Isometric View



Tél: (450) 979-4373
 Fax: (450) 979-4626
www.exmweb.com

Flatness
Aplatissement
Max 3.0mm

Projection

Customer Client	Date
Drawn By / Dessiné Par: BoxCad: BoxCad	Date: 16-Dec-25
Material / Matière: 16 Ga Stainless Steel 304 (1.4mm)	
Color / Couleur: Unpainted	Finish / Fini: Brushed

Qty	Part Number	Rev	Description
1	STK-Q-08500	4	Stainless Steel Standoff M6 x 10mm
1	STK-S-00100	0	3.5" x 2" Silver Milar Flexcon Sticker
1	1412TSS6603G	0	1412TSS 11" x 72" Gasket
1	1412TSS6603C-P	0	1412TSS 11" x 72" Cover Part
Parts List			

Description: 1412TSS 11" x 72" Cover	Detail Rev.
Part Number / Numéro Pièce: 1412TSS6603C	Rev. 10 / 12
	0

This drawing is confidential and must not be reproduced or used without the consent of EXM

Ce dessin est confidentiel et ne doit pas être reproduit ou utilisé sans le consentement de EXM



TOP

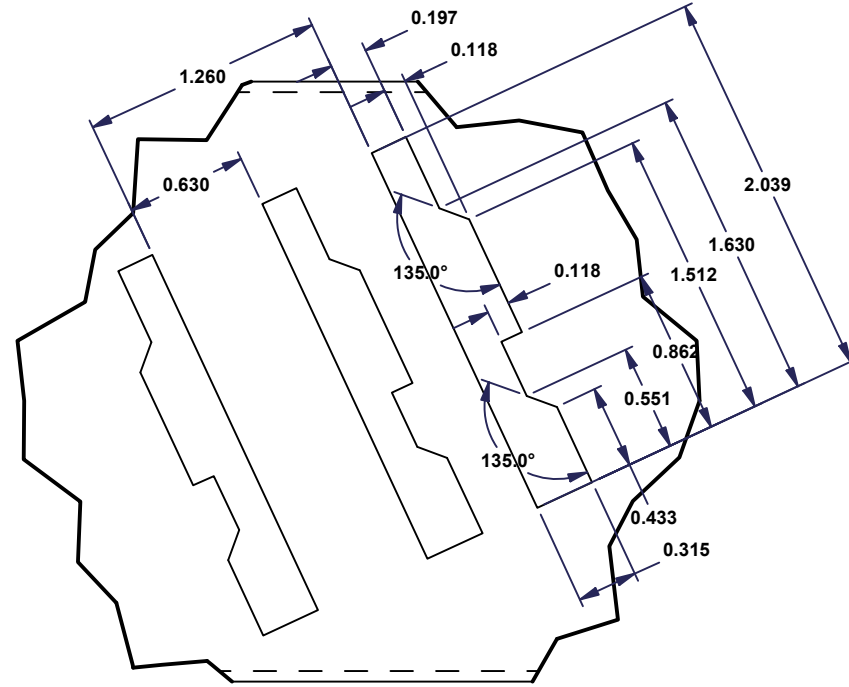

DETAIL A

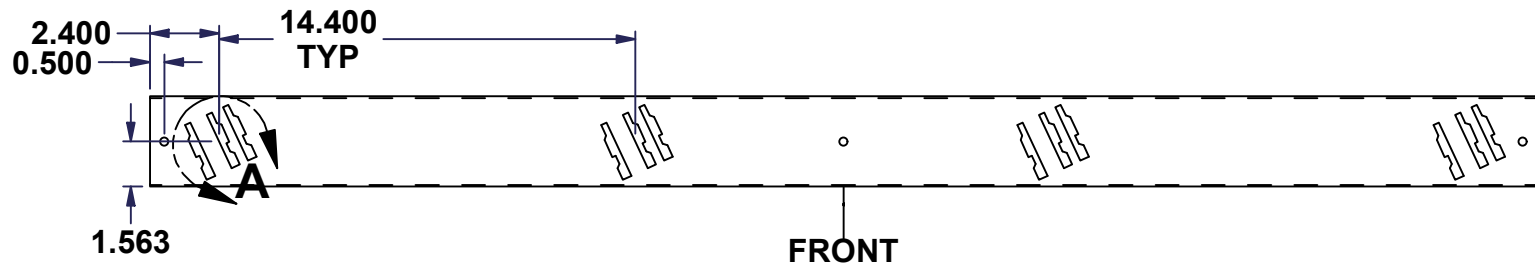

FRONT

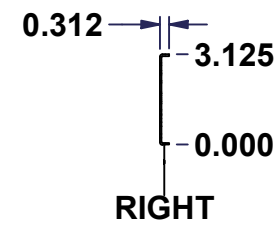

RIGHT



Isometric View



No.	Revisions	Date	By/Par

Tél: (450) 979-4373 Fax: (450) 979-4626 www.exmweb.com		Flatness Aplatissement Max 3.0mm Projection
Customer Client	Date	
Drawn By Dessiné Par	BoxCad: BoxCad	Date 16-Dec-25
Material Matière	16 Ga Galvanized (1.4mm)	
Color Couleur	Unpainted	Finish Fini Unpainted
Description	Detail Rev.	
1412TSS 11" x 72" Inner Panel		
Part Number Numéro Pièce	Rev.	11
1412TSS6603IP	0	12

SEE BILL OF MATERIAL ON LAST PAGE

This drawing is confidential and must not be reproduced or used without the consent of EXM

Ce dessin est confidentiel et ne doit pas être reproduit ou utilisé sans le consentement de EXM

No.	Revisions	Date	By/Par

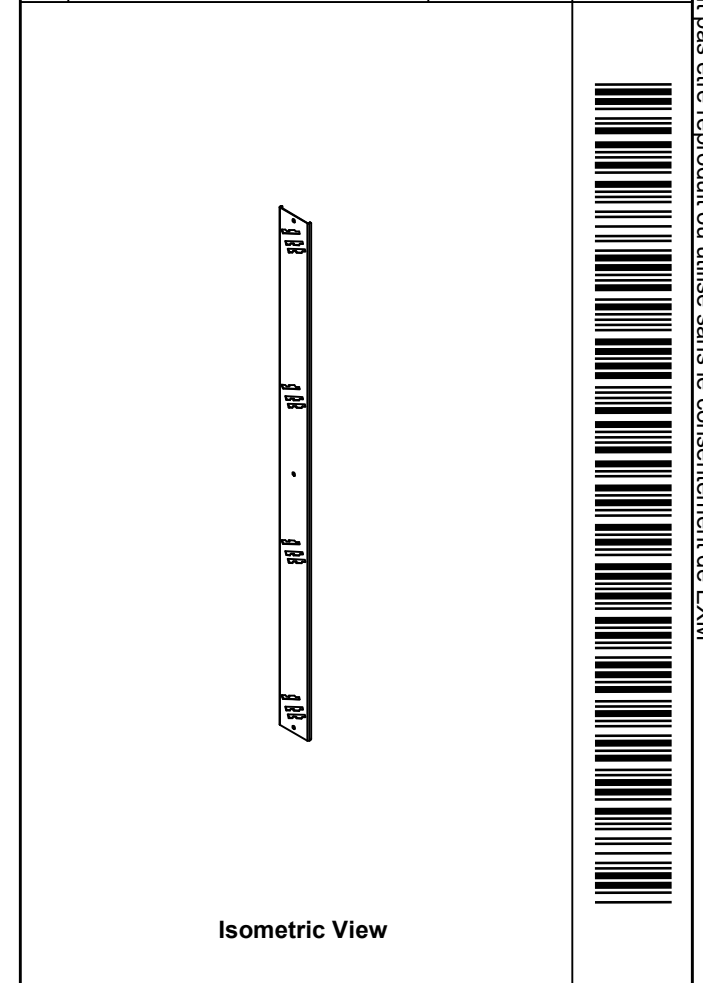

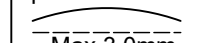
 Tél: (450) 979-4373 Fax: (450) 979-4626 www.exmweb.com		Flatness Aplatissement  Max 3.0mm
Customer Client		Date
Drawn By Dessiné Par BoxCad: BoxCad		Date 16-Dec-25
Material Matière 16 Ga Galvanized (1.4mm)		
Color Couleur Unpainted	Finish Fini Unpainted	
Description 1412TSS 11" x 72" Inner Panel		Detail Rev.
Part Number Numéro Pièce 1412TSS6603IP		Rev. 12 0

Qty	Part Number	Rev	Description
1	1412TSS6603IP-P	0	1412TSS 11" x 72" Inner Panel Part
Parts List			