

This drawing is confidential and must not be reproduced or used without the consent of EXM

Ce dessin est confidentiel et ne doit pas être reproduit ou utilisé sans le consentement de EXM

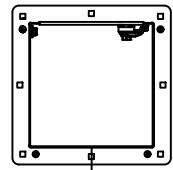

TOP

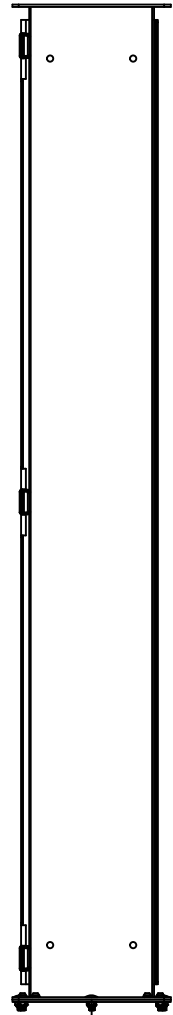

BACK

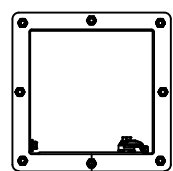

BOTTOM

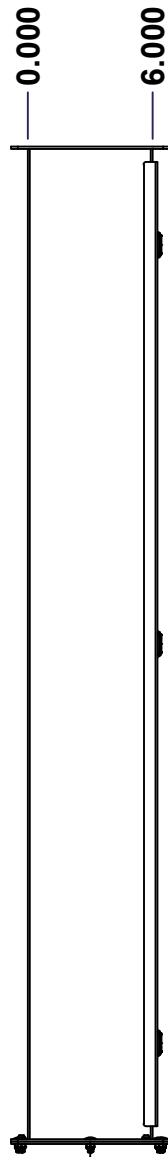

LEFT

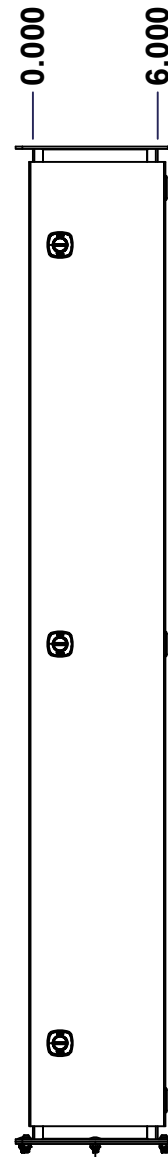

FRONT

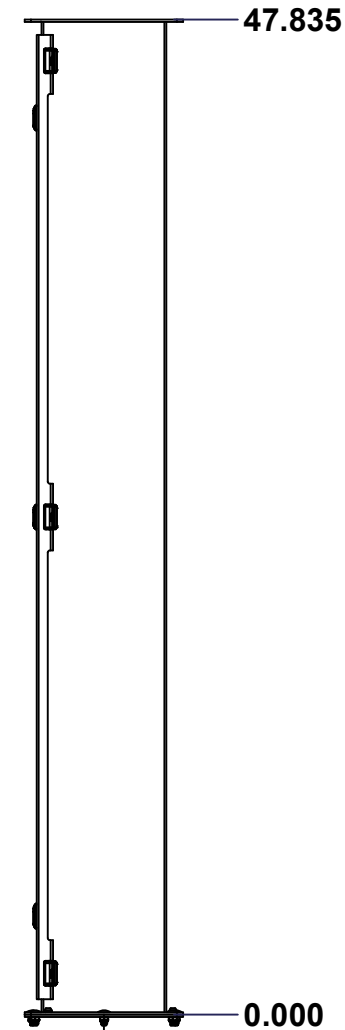

RIGHT

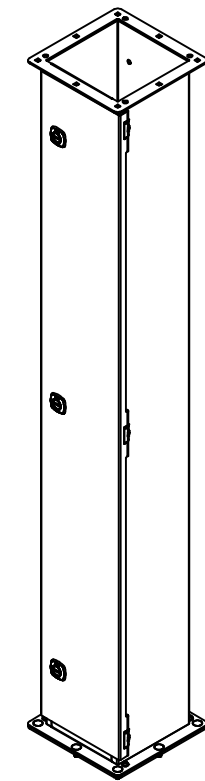

Isometric View



**GRAIN DIRECTION:
TOP/BOTTOM: HORIZONTAL
LEFT/RIGHT/BACK/FRONT: VERTICAL**

No.	Revisions	Date	By/Par

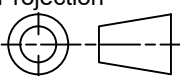
 Tél: (450) 979-4373 Fax: (450) 979-4626 www.exmweb.com		Flatness Aplatissement Max 3.0mm Projection 
Customer Client	Date	
Drawn By Dessiné Par	BoxCad: BoxCad	Date 18-Jul-25
Material Matière	16 Ga Stainless Steel 304 (1.4mm)	
Color Couleur	Unpainted	Finish Fini Brushed
Description	Detail Rev.	
1412XSS 48" x 6" x 6" Assembly		
Part Number Numéro Pièce	Rev.	1
1412XSS6048	0	8

SEE BILL OF MATERIAL ON LAST PAGE

This drawing is confidential and must not be reproduced or used without the consent of EXM

Ce dessin est confidentiel et ne doit pas être reproduit ou utilisé sans le consentement de EXM

NOTE	
ITEM	DESCRIPTION
1	NEMA 4X Enclosure (IP66)

No.	Revisions	Date	By/Par

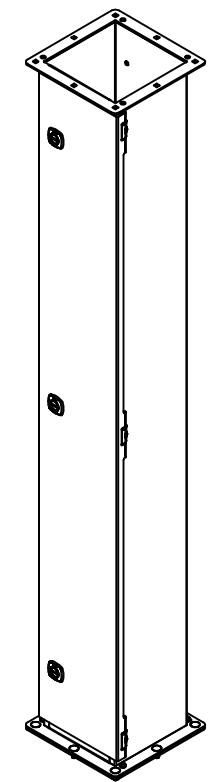

Isometric View



Tél: (450) 979-4373
 Fax: (450) 979-4626
www.exmweb.com



Customer Client	Date
Drawn By / Dessiné Par: BoxCad: BoxCad	Date: 18-Jul-25

Material / Matière	16 Ga Stainless Steel 304 (1.4mm)
--------------------	-----------------------------------

Color / Couleur	Unpainted	Finish / Fini	Brushed
-----------------	-----------	---------------	---------

Description	Detail Rev.
1412XSS 48" x 6" x 6" Assembly	

Part Number / Numéro Pièce	Rev.	2
1412XSS6048	0	8

Qty	Part Number	Rev	Description
8	STK-Q-00266	0	M6 x 16mm Stainless Steel 316 Carriage Bolt
1	STK-G-01620	1	1412 Pull Through Wireway Gasket
1	1412XSS6048C	0	1412XSS 48" x 6" Cover
1	1412XSS6048B	0	1412XSS 48" x 6" x 6" Body
3	STK-A-08126	0	M5 Stainless Steel 316 Nylon Insert Lock Nut with Incorporated Sealing Washer
8	STK-Q-07225	0	M6 Stainless Steel Nylon Insert Lock Nut

Parts List

PACKING		
ITEM	QTY	DESCRIPTION
Cardboard sleeve	2	Top and Bottom
Plastic strap - Black	2	To Squeeze 2 cardboard sleeve together
Packaging label	3	White label with PN

This drawing is confidential and must not be reproduced or used without the consent of EXM

Ce dessin est confidentiel et ne doit pas être reproduit ou utilisé sans le consentement de EXM

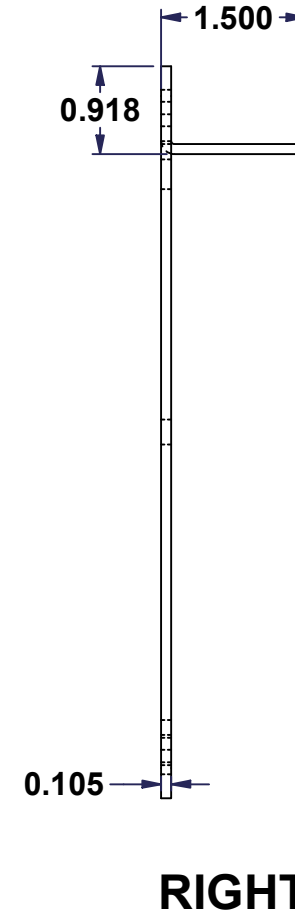
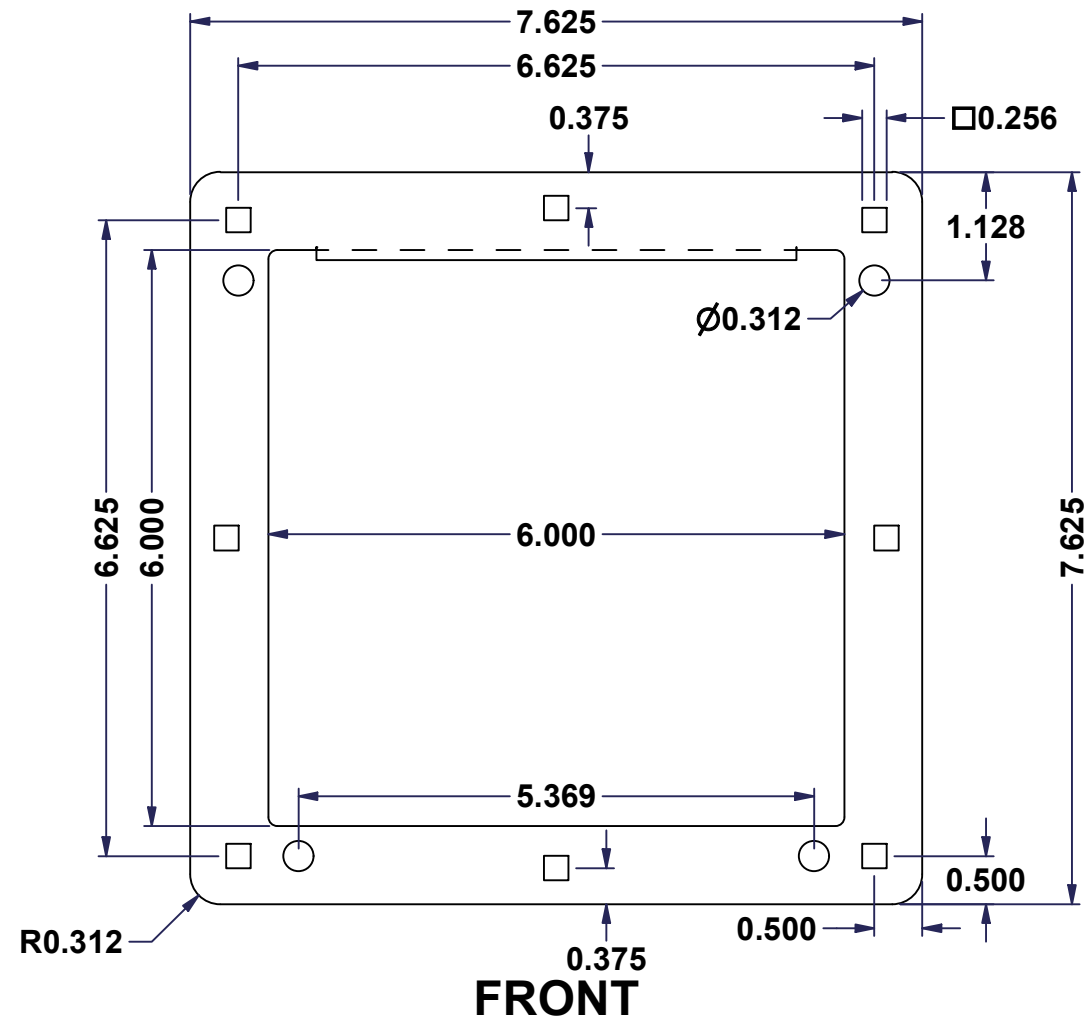

No.	Revisions	Date	By/Par

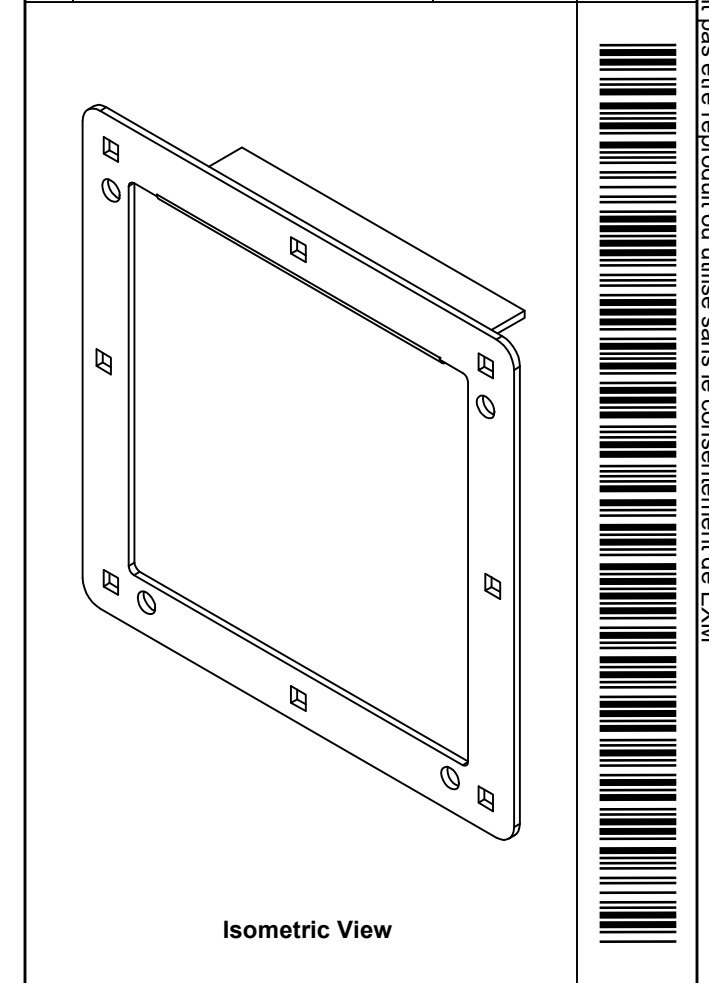

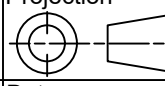
 Tél: (450) 979-4373 Fax: (450) 979-4626 www.exmweb.com		Flatness Aplatissement Max 3.0mm Projection 
Customer Client		Date
Drawn By Dessiné Par	BoxCad: BoxCad	Date 18-Jul-25
Material Matière	12 Ga Stainless Steel 304 (2.5mm)	
Color Couleur	Unpainted	Finish Fini Brushed
Description		Detail Rev.
1412XSS6" x 6" Connector Part		
Part Number Numéro Pièce	Rev.	
1412XSS6048BC-P	0	3 8

This drawing is confidential and must not be reproduced or used without the consent of EXM

Ce dessin est confidentiel et ne doit pas être reproduit ou utilisé sans le consentement de EXM

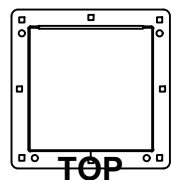

TOP

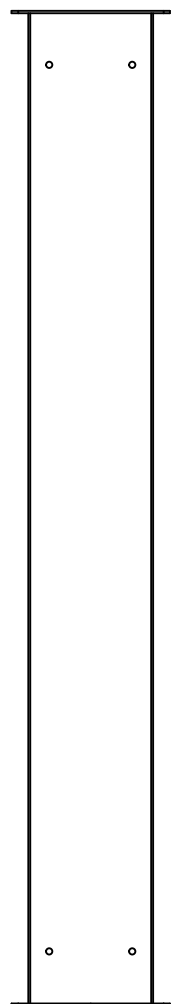

BACK

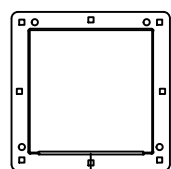

BOTTOM

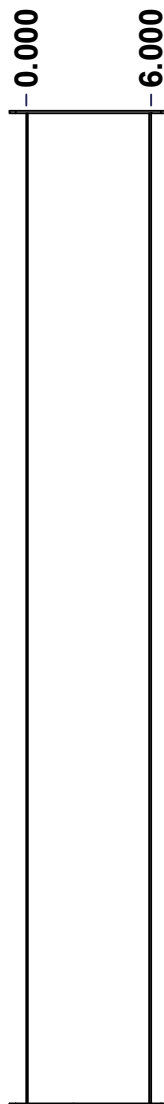

LEFT

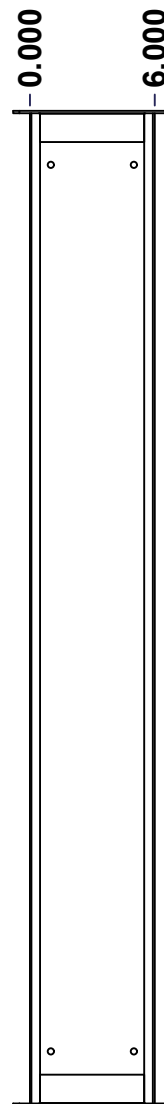

FRONT

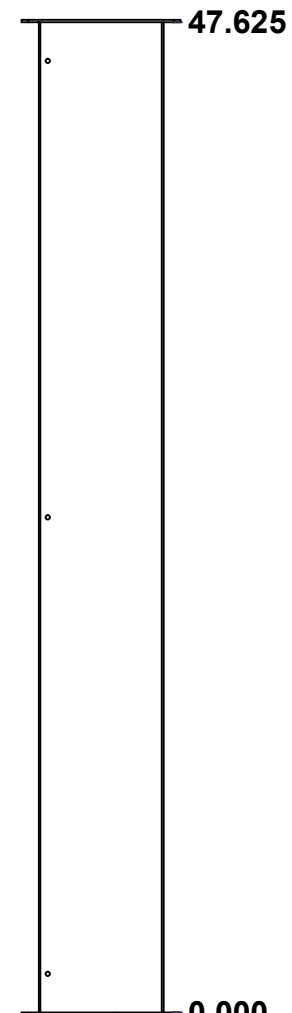

RIGHT

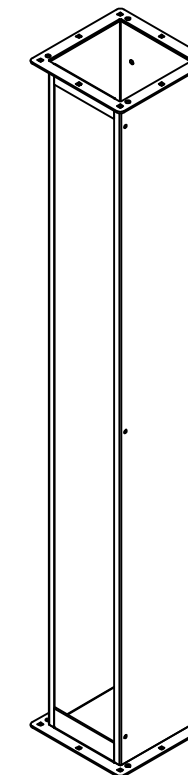

Isometric View



No.	Revisions	Date	By/Par

EXM
exm

Tél: (450) 979-4373
Fax: (450) 979-4626
www.exmweb.com

Flatness
Aplatissement
Max 3.0mm

Projection

Customer Client	Date
Drawn By Dessiné Par	Date 18-Jul-25

Material Matière: 16 Ga Stainless Steel 304 (1.4mm)

Color Couleur: Unpainted	Finish Fini: Brushed
--------------------------	----------------------

Description: 1412XSS 48" x 6" x 6" Body	Detail Rev.
---	-------------

Part Number Numéro Pièce: 1412XSS6048B	Rev. 0	4	8
---	--------	---	---

SEE BILL OF MATERIAL ON LAST PAGE

This drawing is confidential and must not be reproduced or used without the consent of EXM

Ce dessin est confidentiel et ne doit pas être reproduit ou utilisé sans le consentement de EXM

No.	Revisions	Date	By/Par

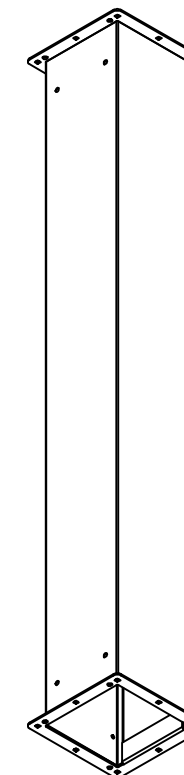

Isometric View

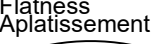
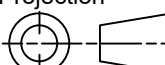

 Tél: (450) 979-4373 Fax: (450) 979-4626 www.exmweb.com		Flatness Aplatissement  Max 3.0mm	
Customer Client		Date	
Drawn By Dessiné Par		Date	
Material Matière		Projection 	
Color Couleur		Finish Fini	
Description		Detail Rev.	
Part Number Numéro Pièce		Rev.	
1412XSS6048B		5	
0		8	

Qty	Part Number	Rev	Description
2	1412XSS6048BC-P	0	1412XSS6" x 6" Connector Part
1	1412XSS6048B-P	0	1412XSS 48" x 6" x 6" Body Part
Parts List			

This drawing is confidential and must not be reproduced or used without the consent of EXM

Ce dessin est confidentiel et ne doit pas être reproduit ou utilisé sans le consentement de EXM

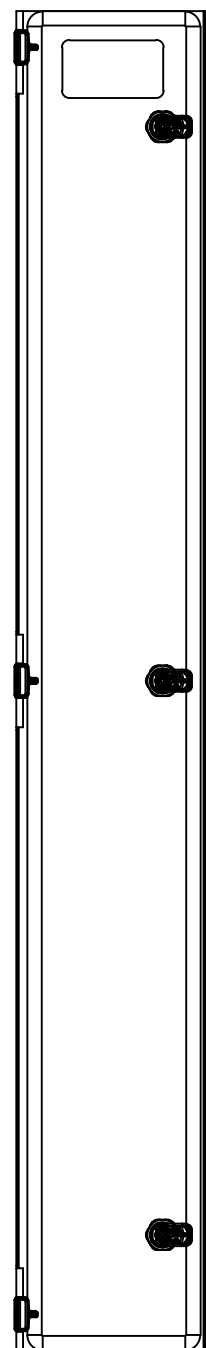
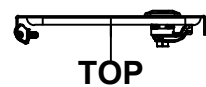

BACK



BOTTOM

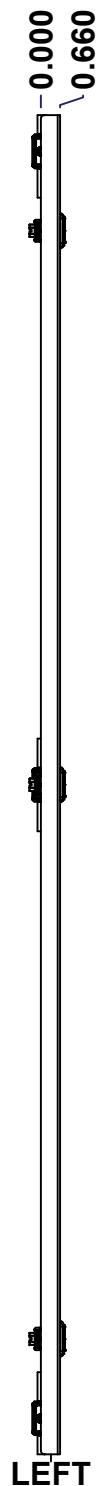

LEFT

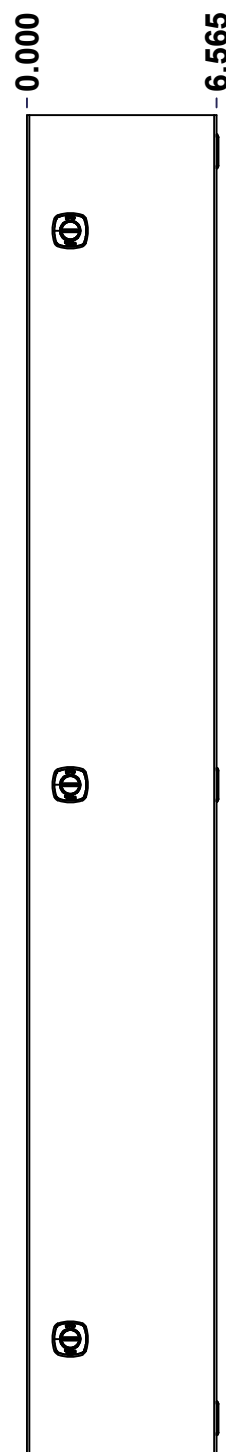

FRONT

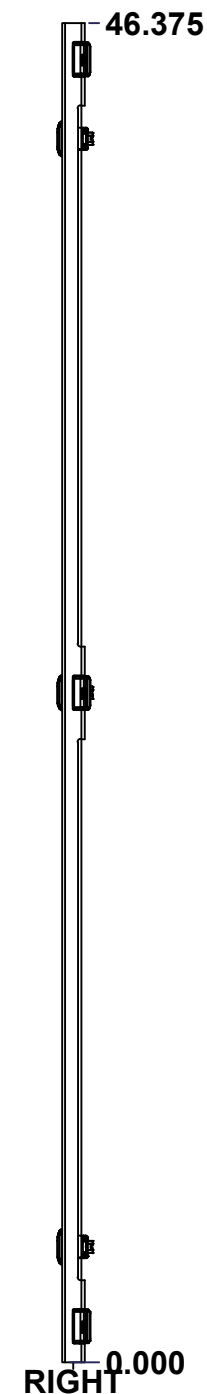

RIGHT

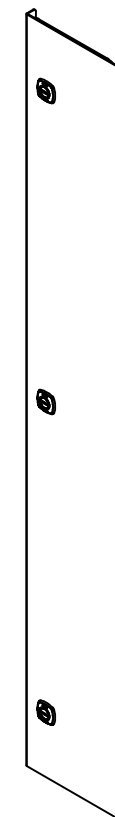

Isometric View

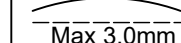
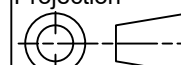

No.	Revisions	Date	By/Par

 Tél: (450) 979-4373 Fax: (450) 979-4626 www.exmweb.com		Flatness Aplatissement  Max 3.0mm Projection 
Customer Client	Date	
Drawn By Dessiné Par	BoxCad: BoxCad	Date 18-Jul-25
Material Matière	16 Ga Stainless Steel 304 (1.4mm)	
Color Couleur	Unpainted	Finish Fini Brushed
Description	Detail Rev.	
1412XSS 48" x 6" Cover		
Part Number Numéro Pièce	Rev.	6
1412XSS6048C	0	8

SEE BILL OF MATERIAL ON LAST PAGE

This drawing is confidential and must not be reproduced or used without the consent of EXM

Ce dessin est confidentiel et ne doit pas être reproduit ou utilisé sans le consentement de EXM

STANDARD FEATURES ARE NOT LISTED IN THIS HOLE TABLE			
HOLE TABLE - FRONT VIEW (CUSTOM FEATURE ONLY)			
CUT-OUT	XDIM	YDIM	DESCRIPTION
1	3.000	44.375	LABEL_EXM
2	5.065	42.375	LOCK 880 SCQ4CH-SLSS @ 180.0°
3	5.065	23.188	LOCK 880 SCQ4CH-SLSS @ 180.0°
4	5.065	4.000	LOCK 880 SCQ4CH-SLSS @ 180.0°

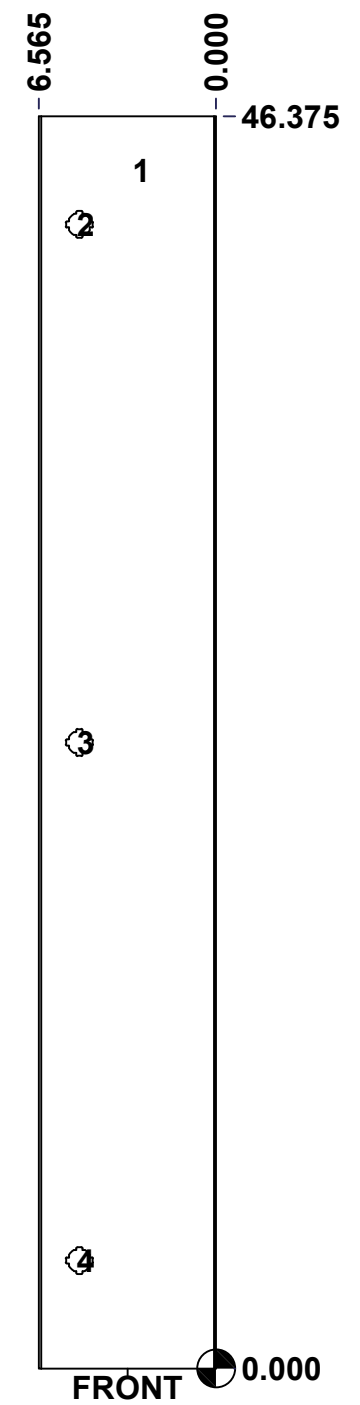

	Description	Status	
	1412XSS 48" x 6" x 6" Cover	(NULL)	
	Part Number Numéro Pièce	Rev.	
	1412XSS6048C	0	7 8

This drawing is confidential and must not be reproduced or used without the consent of EXM

Ce dessin est confidentiel et ne doit pas être reproduit ou utilisé sans le consentement de EXM

No.	Revisions	Date	By/Par

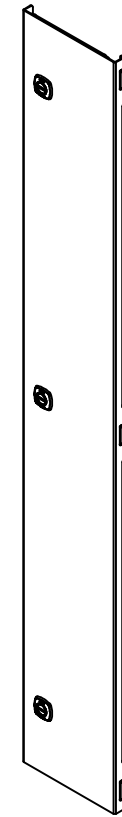

Isometric View

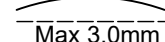

 Tél: (450) 979-4373 Fax: (450) 979-4626 www.exmweb.com		Flatness Aplatissement  Max 3.0mm
Customer Client		Date
Drawn By Dessiné Par	BoxCad: BoxCad	Date 18-Jul-25
Material Matière 16 Ga Stainless Steel 304 (1.4mm)		
Color Couleur	Unpainted	Finish Fini Brushed
Description 1412XSS 48" x 6" Cover		Detail Rev.
Part Number Numéro Pièce 1412XSS6048C		Rev. 8 0

Qty	Part Number	Rev	Description
1	STK-S-00100	0	3.5" x 2" Silver Milar Flexcon Sticker
1	1412XSS6048G	0	1412XSS 48" x 6" Cover Gasket Part
1	1412XSS6048C-P	0	1412XSS 48" x 6" x 6" Cover Part
3	STK-A-33033	4	5412 ESMCH Hinge
3	880 SCQ4CH-SLSS	0	5412 CHSS 1/4 Turn Lock
Parts List			