

This drawing is confidential and must not be reproduced or used without the consent of EXM

Ce dessin est confidentiel et ne doit pas être reproduit ou utilisé sans le consentement de EXM

No.	Revisions	Date	By/Par

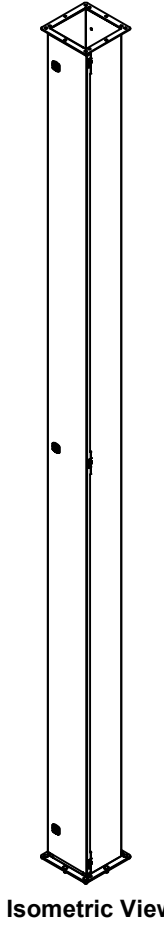
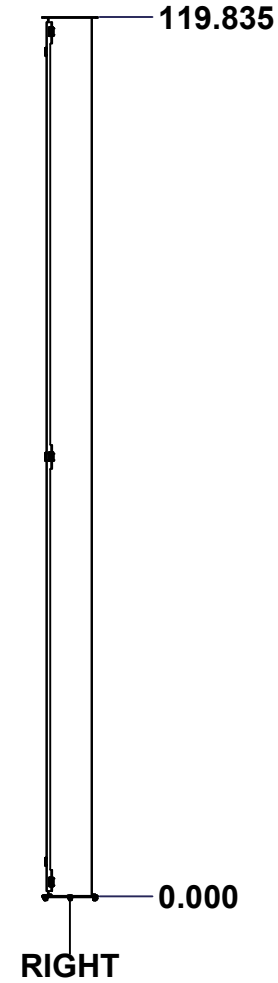
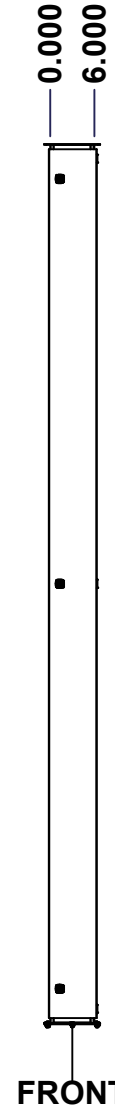
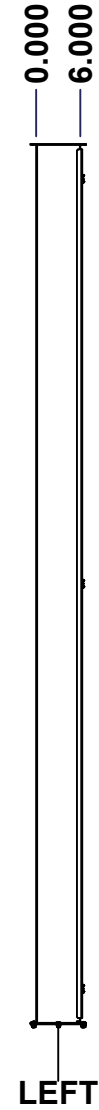
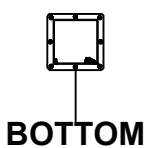
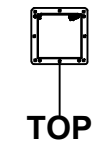

**GRAIN DIRECTION:
TOP/BOTTOM: HORIZONTAL
LEFT/RIGHT/BACK/FRONT: VERTICAL**

SEE BILL OF MATERIAL ON LAST PAGE

Tél: (450) 979-4373 Fax: (450) 979-4626 www.exmweb.com		Flatness Aplatissement Max 3.0mm Projection
Customer Client	Date	
Drawn By Dessiné Par	BoxCad: BoxCad	Date 18-Jul-25
Material Matière	16 Ga Stainless Steel 304 (1.4mm)	
Color Couleur	Unpainted	Finish Fini Brushed
Description	Detail Rev.	
1412XSS 120" x 6" x 6" Assembly		
Part Number Numéro Pièce	Rev. 0	1 8
1412XSS6120		

This drawing is confidential and must not be reproduced or used without the consent of EXM

Ce dessin est confidentiel et ne doit pas être reproduit ou utilisé sans le consentement de EXM

NOTE	
ITEM	DESCRIPTION
1	NEMA 4X Enclosure (IP66)

No.	Revisions	Date	By/Par

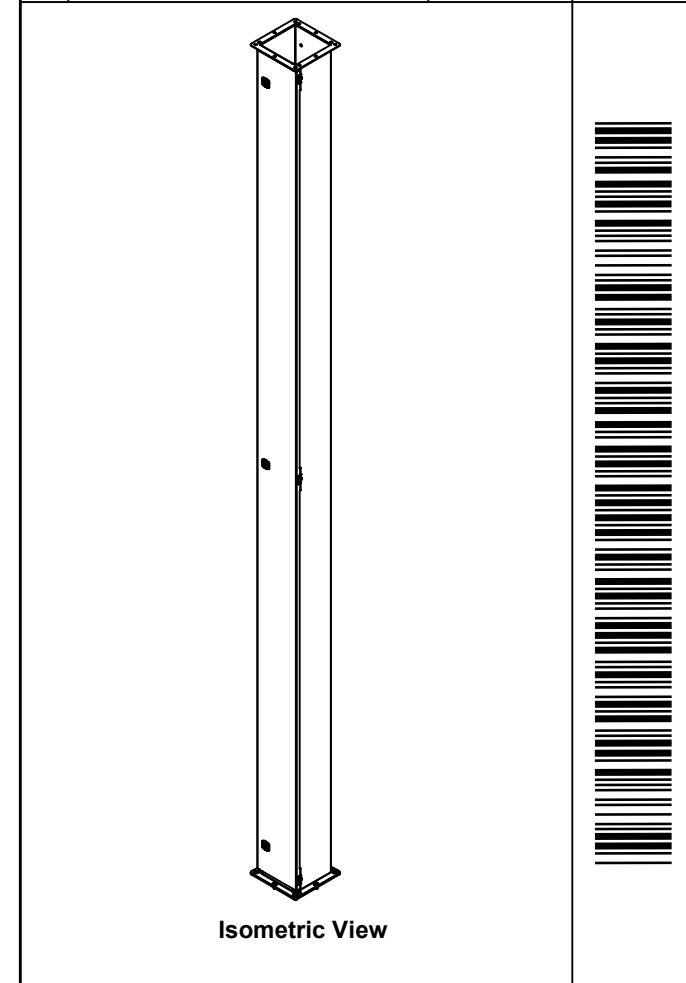

 Tél: (450) 979-4373
 Fax: (450) 979-4626
www.exmweb.com

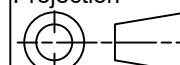
Flatness
 Aplatissement
 Max 3.0mm
 Projection

Customer Client	Date
Drawn By Dessiné Par BoxCad: BoxCad	Date 18-Jul-25

Material Matière	16 Ga Stainless Steel 304 (1.4mm)
---------------------	-----------------------------------

Color Couleur	Unpainted	Finish Fini	Brushed
------------------	-----------	----------------	---------

Description	Detail Rev.
1412XSS 120" x 6" x 6" Assembly	

Part Number Numéro Pièce	Rev.	2
1412XSS6120	0	8

Qty	Part Number	Rev	Description
8	STK-Q-07225	0	M6 Stainless Steel Nylon Insert Lock Nut
8	STK-Q-00266	0	M6 x 16mm Stainless Steel 316 Carriage Bolt
1	STK-G-01620	1	1412 Pull Through Wireway Gasket
3	STK-A-08126	0	M5 Stainless Steel 316 Nylon Insert Lock Nut with Incorporated Sealing Washer
1	1412XSS6120C	0	1412XSS 120" x 6" Cover
1	1412XSS6120B	0	1412XSS 120" x 6" x 6" Body
Parts List			

PACKING		
ITEM	QTY	DESCRIPTION
Cardboard sleeve	2	Top and Bottom
Plastic strap - Black	2	To Squeeze 2 cardboard sleeve together
Packaging label	3	White label with PN

This drawing is confidential and must not be reproduced or used without the consent of EXM

Ce dessin est confidentiel et ne doit pas être reproduit ou utilisé sans le consentement de EXM

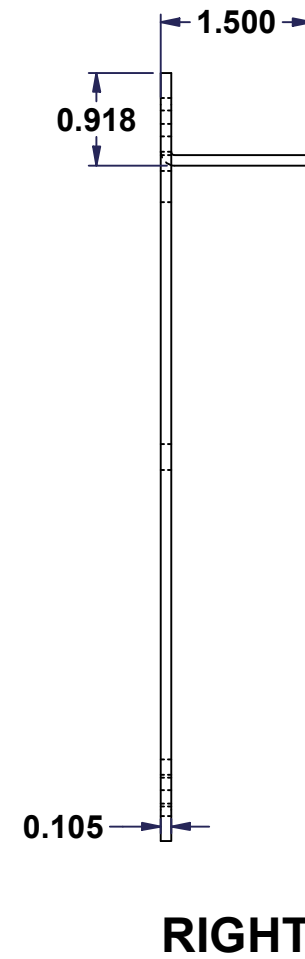
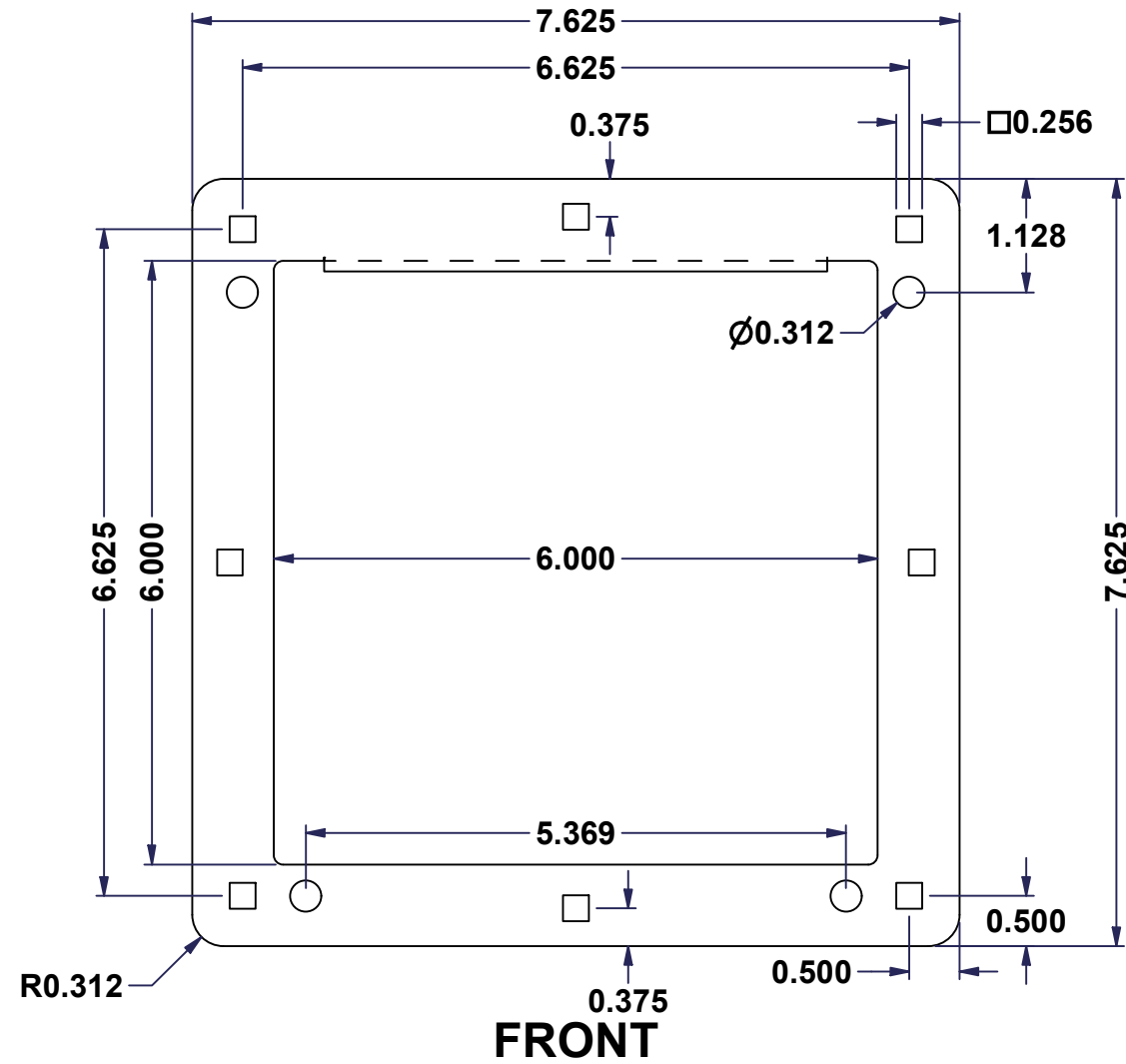

No.	Revisions	Date	By/Par

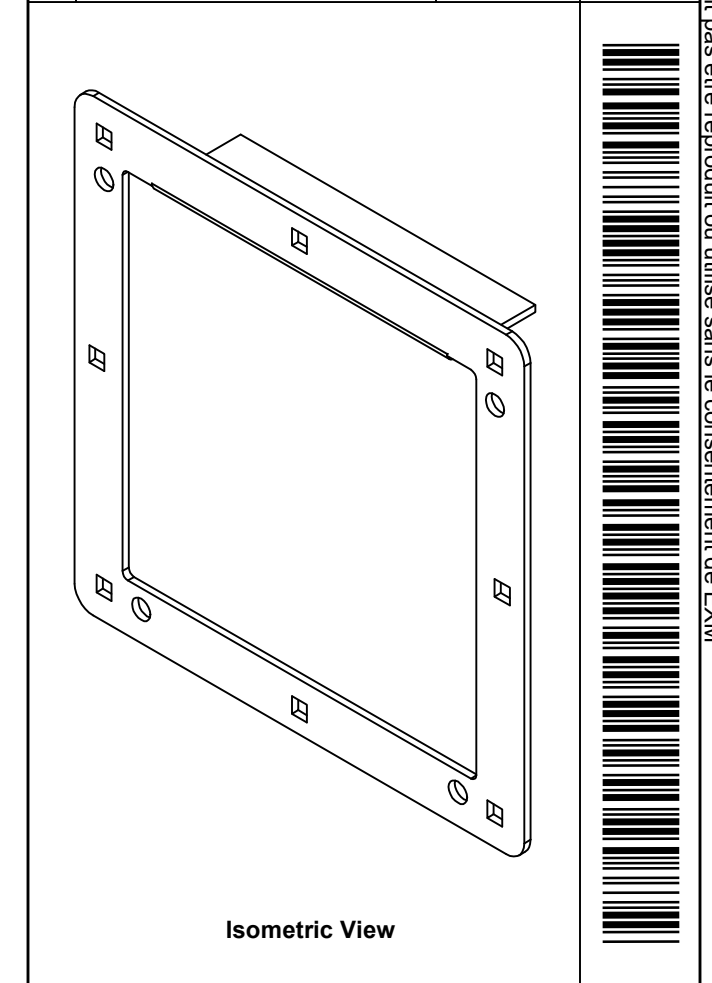

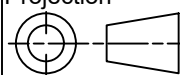
 Tél: (450) 979-4373 Fax: (450) 979-4626 www.exmweb.com		Flatness Aplatissement Max 3.0mm Projection 
Customer Client	Date	
Drawn By Dessiné Par	BoxCad: BoxCad	Date 18-Jul-25
Material Matière	12 Ga Stainless Steel 304 (2.5mm)	
Color Couleur	Unpainted	Finish Fini Brushed
Description 1412XSS6" x 6" Connector Part		Detail Rev.
Part Number Numéro Pièce	Rev. 0	3/8
1412XSS6120BC-P		

This drawing is confidential and must not be reproduced or used without the consent of EXM

Ce dessin est confidentiel et ne doit pas être reproduit ou utilisé sans le consentement de EXM

No.	Revisions	Date	By/Par

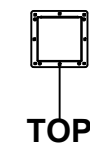

BACK

0.000
6.000

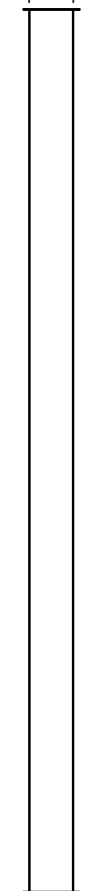

LEFT

0.000
6.000

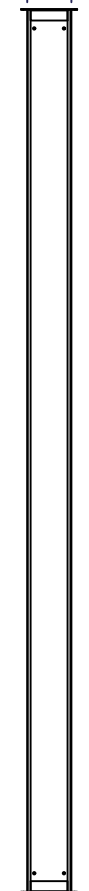

FRONT

119.625

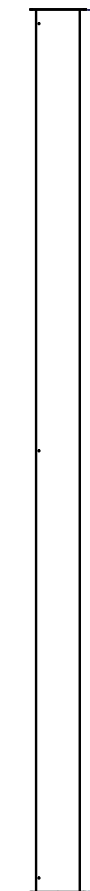

RIGHT

0.000

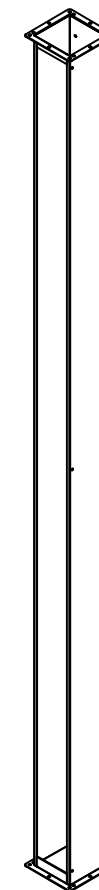

Isometric View



Tél: (450) 979-4373
Fax: (450) 979-4626
www.exmweb.com

Flatness
Aplatissement

Max 3.0mm

Projection

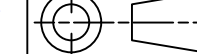

Customer Client	Date
Drawn By Dessiné Par BoxCad: BoxCad	Date 18-Jul-25
Material Matière 16 Ga Stainless Steel 304 (1.4mm)	
Color Couleur Unpainted	Finish Fini Brushed
Description 1412XSS 120" x 6" x 6" Body	Detail Rev.
Part Number Numéro Pièce 1412XSS6120B	Rev. 4 0

SEE BILL OF MATERIAL ON LAST PAGE

This drawing is confidential and must not be reproduced or used without the consent of EXM

Ce dessin est confidentiel et ne doit pas être reproduit ou utilisé sans le consentement de EXM

No.	Revisions	Date	By/Par

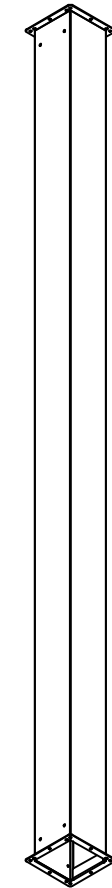

Isometric View

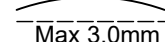

 Tél: (450) 979-4373 Fax: (450) 979-4626 www.exmweb.com		Flatness Aplatissement  Max 3.0mm	
Customer Client		Date	
Drawn By Dessiné Par BoxCad: BoxCad		Date 18-Jul-25	
Material Matière 16 Ga Stainless Steel 304 (1.4mm)			
Color Couleur Unpainted		Finish Fini Brushed	
Description 1412XSS 120" x 6" x 6" Body			Detail Rev.
Part Number Numéro Pièce		Rev.	5 8
1412XSS6120B		0	

Qty	Part Number	Rev	Description
2	1412XSS6120BC-P	0	1412XSS6" x 6" Connector Part
1	1412XSS6120B-P	0	1412XSS 120" x 6" x 6" Body Part
Parts List			

This drawing is confidential and must not be reproduced or used without the consent of EXM

Ce dessin est confidentiel et ne doit pas être reproduit ou utilisé sans le consentement de EXM

TOP



BACK

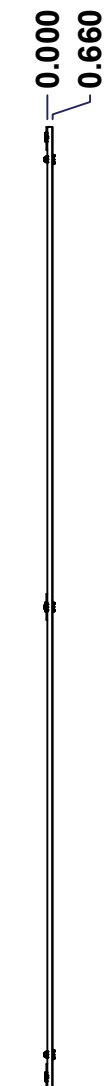

LEFT

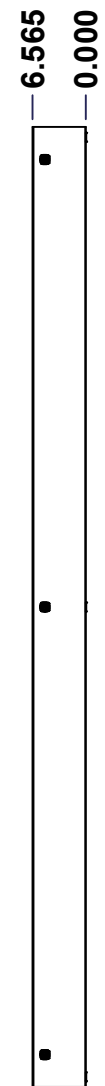

FRONT

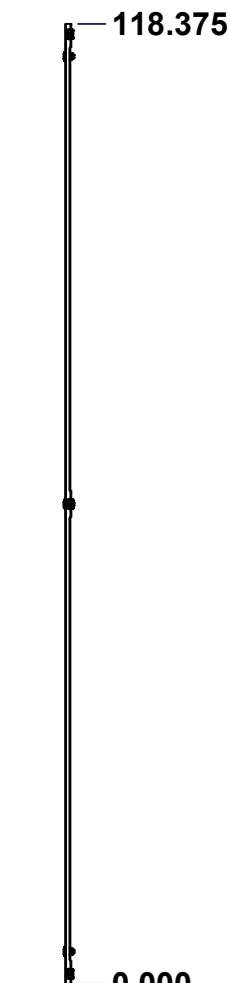

RIGHT

BOTTOM

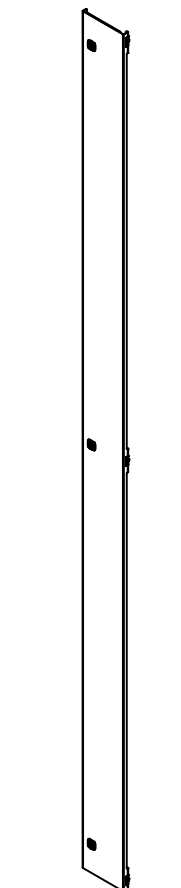

Isometric View

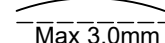

No.	Revisions	Date	By/Par

 Tél: (450) 979-4373 Fax: (450) 979-4626 www.exmweb.com		Flatness Aplatissement  Max 3.0mm
Customer Client		Date
Drawn By Dessiné Par BoxCad: BoxCad		Date 18-Jul-25
Material Matière 16 Ga Stainless Steel 304 (1.4mm)		
Color Couleur Unpainted	Finish Fini Brushed	
Description 1412XSS 120" x 6" Cover		Detail Rev.
Part Number Numéro Pièce 1412XSS6120C		Rev. 6 0

SEE BILL OF MATERIAL ON LAST PAGE

This drawing is confidential and must not be reproduced or used without the consent of EXM

Ce dessin est confidentiel et ne doit pas être reproduit ou utilisé sans le consentement de EXM

STANDARD FEATURES ARE NOT LISTED IN THIS HOLE TABLE			
HOLE TABLE - FRONT VIEW (CUSTOM FEATURE ONLY)			
CUT-OUT	XDIM	YDIM	DESCRIPTION
1	3.000	116.375	LABEL_EXM (Inside)
2	5.065	4.000	LOCK 880 SCQ4CH-SLSS @ 180.0°
3	5.065	59.188	LOCK 880 SCQ4CH-SLSS @ 180.0°
4	5.065	114.375	LOCK 880 SCQ4CH-SLSS @ 180.0°

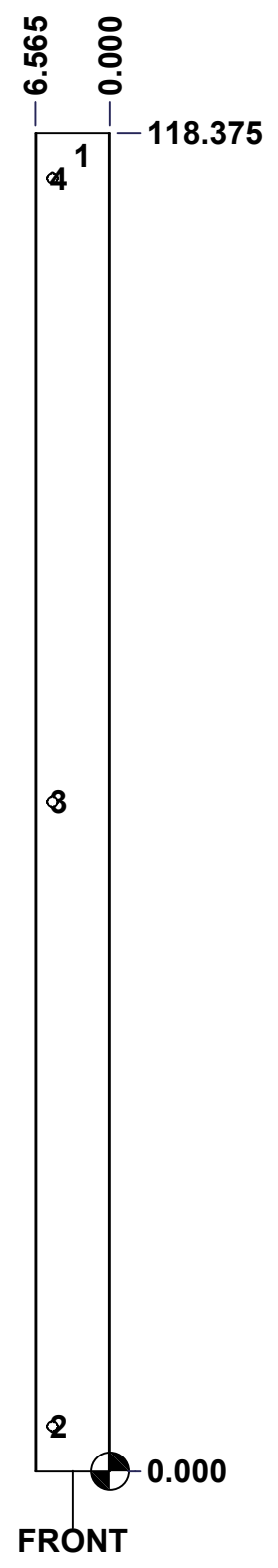

	Description	Status	
	1412XSS 120" x 6" Cover	(NULL)	
	Part Number Numéro Pièce	Rev.	
	1412XSS6120C	0	7/8

This drawing is confidential and must not be reproduced or used without the consent of EXM

Ce dessin est confidentiel et ne doit pas être reproduit ou utilisé sans le consentement de EXM

No.	Revisions	Date	By/Par

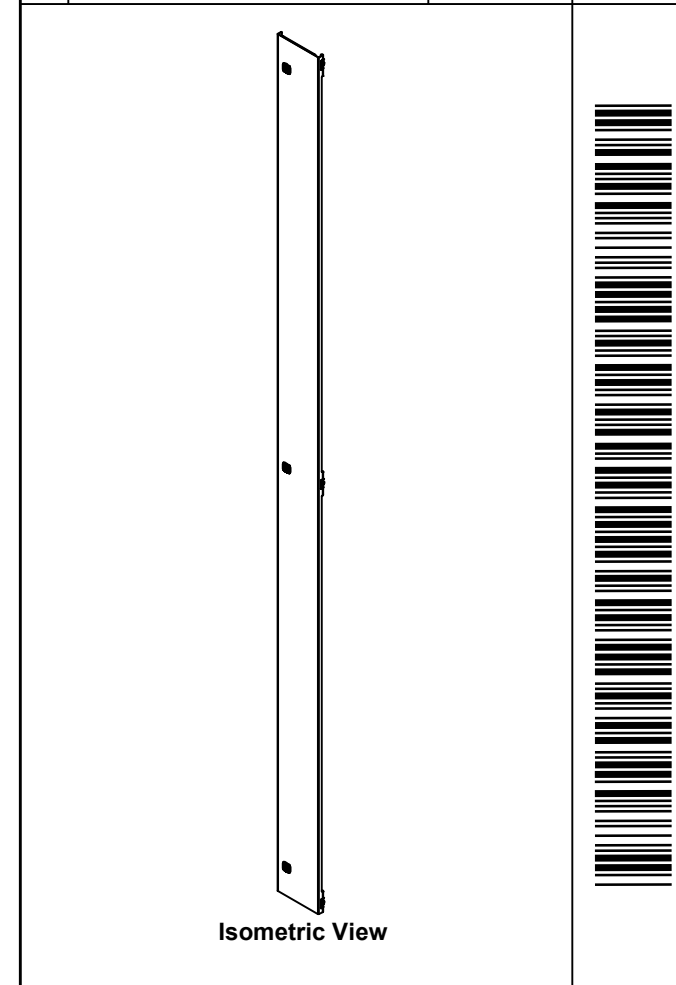

EXM
exm

Tél: (450) 979-4373
Fax: (450) 979-4626
www.exmweb.com

Flatness
Aplatissement
Max 3.0mm

Projection

Customer Client	Date
Drawn By / Dessiné Par: BoxCad: BoxCad	Date: 18-Jul-25
Material / Matière: 16 Ga Stainless Steel 304 (1.4mm)	

Color / Couleur: Unpainted	Finish / Fini: Brushed
Description: 1412XSS 120" x 6" Cover	
Part Number / Numéro Pièce: 1412XSS6120C	Rev. 8
	0

QTY	Part Number	Rev	Description
3	880 SCQ4CH-SLSS	0	5412 CHSS 1/4 Turn Lock
1	STK-S-00100	0	3.5" x 2" Silver Milar Flexcon Sticker
3	STK-A-33033	6	5412 ESCH Hinge Assembly
1	1412XSS6120G	0	1412XSS 120" x 6" Cover Gasket Part
1	1412XSS6120C-P	0	1412XSS 120" x 6" x 6" Cover Part
Parts List			