

This drawing is confidential and must not be reproduced or used without the consent of EXM

Ce dessin est confidentiel et ne doit pas être reproduit ou utilisé sans le consentement de EXM

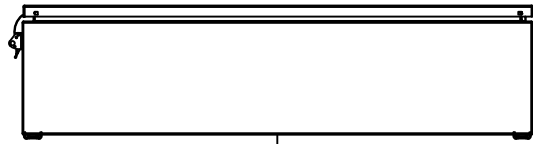

TOP

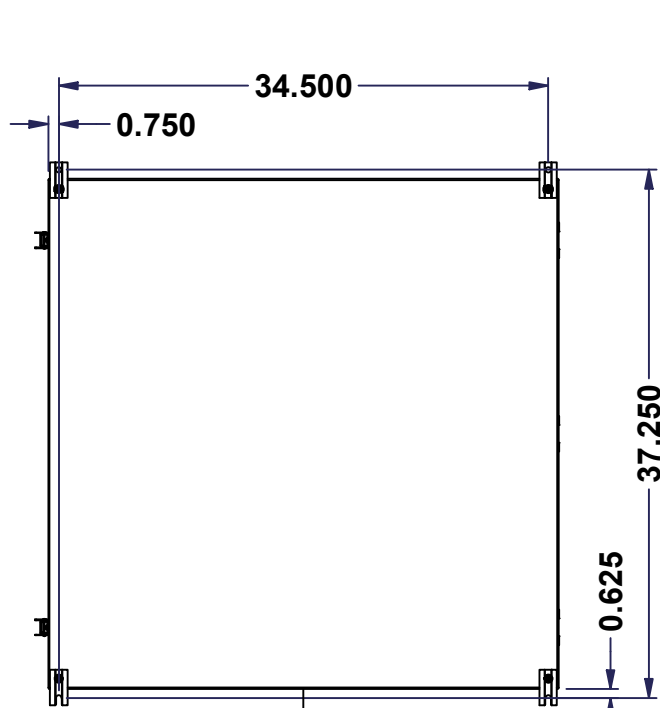

BACK

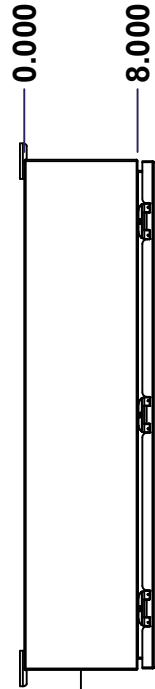

LEFT

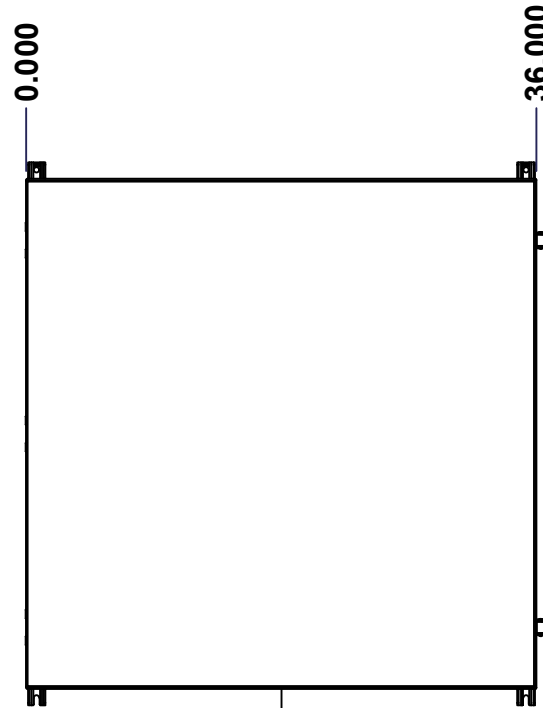

FRONT



RIGHT

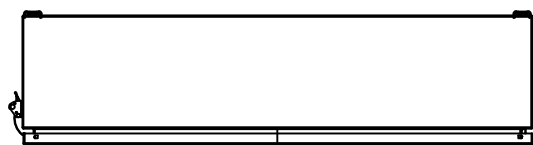

BOTTOM

| No. | Revisions | Date | By/Par |
|-----|-----------|------|--------|
| | | | |
| | | | |
| | | | |
| | | | |

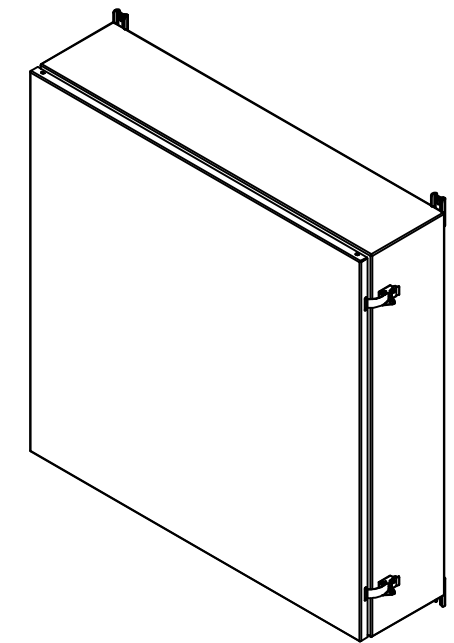

Isometric View



Tél: (450) 979-4373
 Fax: (450) 979-4626
www.exmweb.com

Flatness
Aplatissement

Max 3.0mm

Projection



| | |
|---|-----------------------|
| Customer Client | Date |
| Drawn By / Dessiné Par: BoxCad: BoxCad | Date: 16-Dec-24 |
| Material / Matière: 14 Ga Cold Rolled A1008 CS Type B (1.7mm) | |
| Color / Couleur: Asa-61 Grey | Finish / Fini: Smooth |

| | |
|---|-------------|
| Description: 5300ES 36" x 36" x 8" Assembly | Detail Rev. |
| Part Number / Numéro Pièce: 5300ES363608TH | Rev. 1 |

SEE BILL OF MATERIAL ON LAST PAGE

5300ES363608TH

| | |
|--------|----|
| Rev. 0 | 1 |
| | 16 |

This drawing is confidential and must not be reproduced or used without the consent of EXM

Ce dessin est confidentiel et ne doit pas être reproduit ou utilisé sans le consentement de EXM

| NOTE | |
|------|---|
| ITEM | DESCRIPTION |
| 1 | NEMA 3, 3R Enclosure (IP64) |
| 2 | C/W Standard ground studs on box and cover |
| 3 | C/W Standard door stiffener |
| 4 | C/W Standard inner panel (Included) |
| 5 | C/W Standard inner panel mounting studs |
| 6 | C/W 885 ESMF3_OPEN Sold separately (Installed) |
| 7 | C/W 885 ESMF3_CLOSE Sold separately (Installed) |
| 8 | C/W R5 Insulation (Installed aluminum visible) |

| No. | Revisions | Date | By/Par |
|-----|-----------|------|--------|
| | | | |
| | | | |
| | | | |
| | | | |
| | | | |

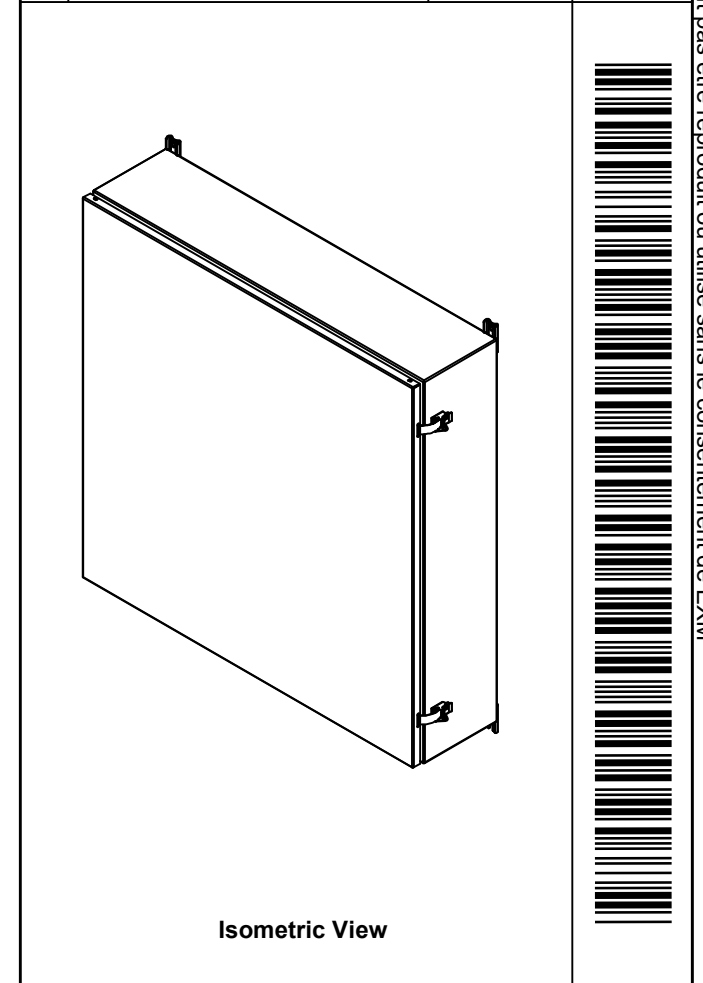

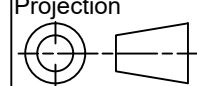
| | |
|--|---|
|  Tél: (450) 979-4373 Fax: (450) 979-4626 www.exmweb.com | Flatness Aplatissement Max 3.0mm |
| | Projection  |
| Customer Client | Date |
| Drawn By / Dessiné Par: BoxCad: BoxCad | Date: 16-Dec-24 |
| Material / Matière: 14 Ga Cold Rolled A1008 CS Type B (1.7mm) | |

| PACKING | | |
|-----------------------|-----|--|
| ITEM | QTY | DESCRIPTION |
| Cardboard sleeve | 2 | Top and Bottom |
| Cardboard strip | 2 | Between back of enclosure and inner panel |
| Plastic bag | 1 | To protect cover surface and inside gasket |
| Plastic strap - Black | 2 | To Squeeze the 2 cardboard sleeve together |
| Packaging label | 1 | White label with product number |

| Qty | Part Number | Rev | Description |
|------------|-----------------|-----|--|
| 8 | STK-Q-00600 | 2 | M12 to M8 Adaptor |
| 1 | 881 SP3636G | 0 | 881 SP - Inner Panel |
| 1 | STK-K-03000 | 1 | 5100 ES Accessory Kit |
| 1 | 5300ES363608THC | 0 | 5300ES 36" x 36" Cover |
| 1 | 5300ES363608THB | 0 | 5300ES 36" x 36" x 8" Body |
| 2 | STK-K-11910 | 3 | Stainless Steel Draw Pull Latch (Long) |
| 3 | STK-Q-04050-08 | 0 | M6 x 8mm Hexagon Socket Head Machine Screw |
| Parts List | | | |

| | |
|---|-----------------------|
| Color / Couleur: Asa-61 Grey | Finish / Fini: Smooth |
| Description: 5300ES 36" x 36" x 8" Assembly | |
| Part Number / Numéro Pièce: 5300ES363608TH | Rev. 0 |
| 2 / 16 | |

This drawing is confidential and must not be reproduced or used without the consent of EXM

Ce dessin est confidentiel et ne doit pas être reproduit ou utilisé sans le consentement de EXM

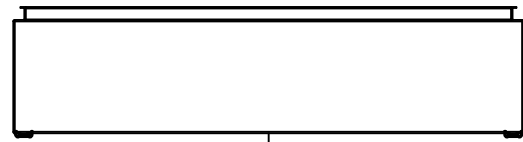

TOP

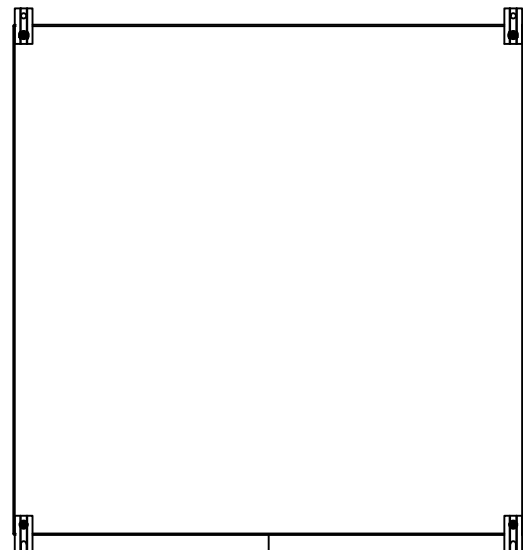

BACK

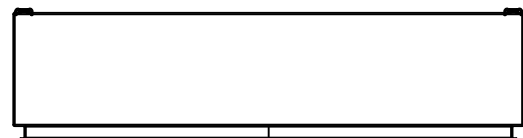

BOTTOM

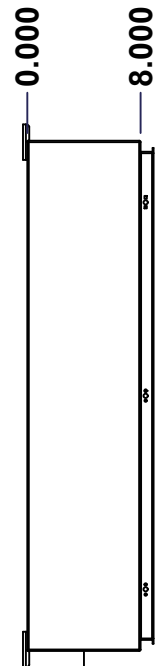

LEFT

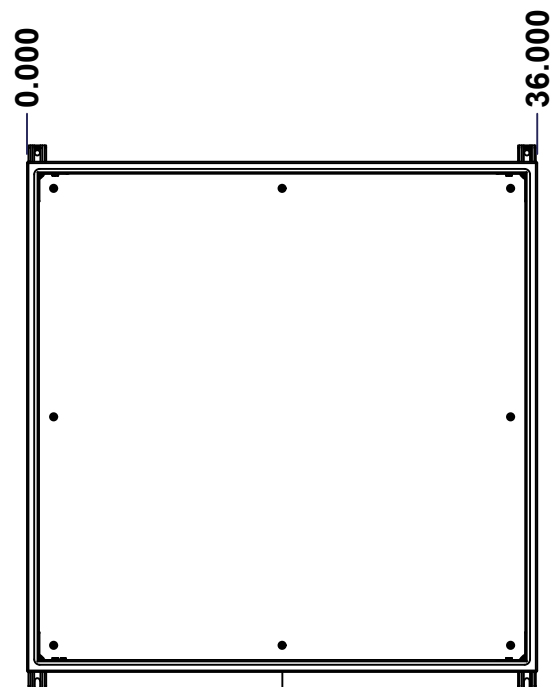

FRONT

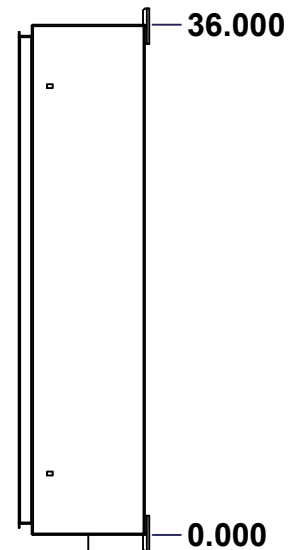

RIGHT

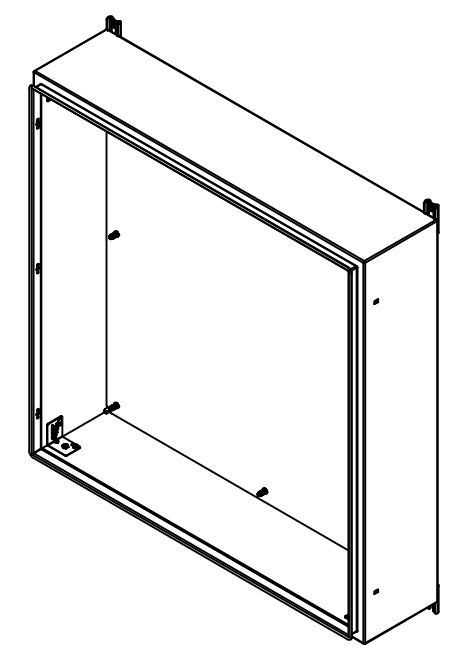

Isometric View

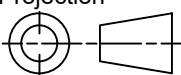

| No. | Revisions | Date | By/Par |
|-----|-----------|------|--------|
| | | | |
| | | | |
| | | | |
| | | | |

| | | |
|--|---|---|
|  Tél: (450) 979-4373 Fax: (450) 979-4626 www.exmweb.com | | Flatness Aplatissement Max 3.0mm Projection  |
| Customer Client | Date | |
| Drawn By Dessiné Par | BoxCad: BoxCad | Date 16-Dec-24 |
| Material Matière | 14 Ga Cold Rolled A1008 CS Type B (1.7mm) | |
| Color Couleur | Asa-61 Grey | Finish Fini Smooth |
| Description | Detail Rev. | |
| 5300ES 36" x 36" x 8" Body | | |
| Part Number Numéro Pièce | Rev. 0 | 3 / 16 |

SEE BILL OF MATERIAL ON LAST PAGE

5300ES363608THB

This drawing is confidential and must not be reproduced or used without the consent of EXM

Ce dessin est confidentiel et ne doit pas être reproduit ou utilisé sans le consentement de EXM

| STANDARD FEATURES ARE NOT LISTED IN THIS HOLE TABLE | | | |
|---|--------|-------|--------------------------------|
| HOLE TABLE - TOP VIEW (CUSTOM FEATURE ONLY) | | | |
| CUT-OUT | XDIM | YDIM | DESCRIPTION |
| 1 | 2.000 | 6.500 | INSUL. STUD M6 x 18mm (Inside) |
| 2 | 34.000 | 6.500 | INSUL. STUD M6 x 18mm (Inside) |

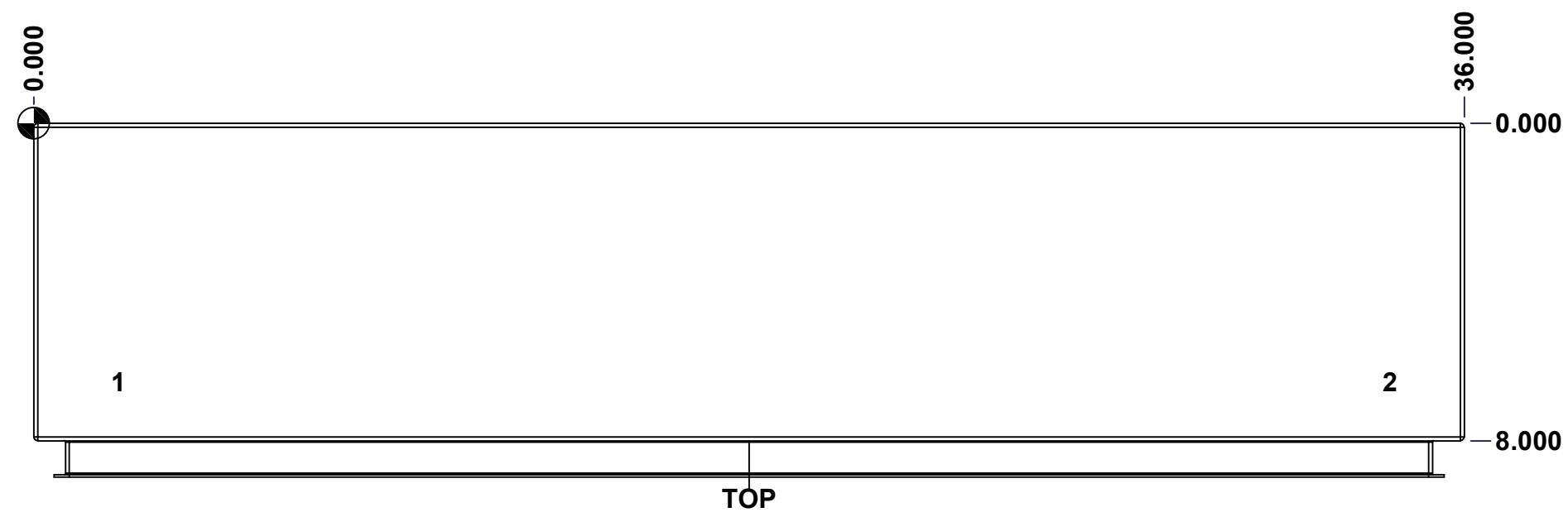

| | | |
|---|----------------------------|--------|
| | Description | Status |
| | 5300ES 36" x 36" x 8" Body | (NULL) |
| Part Number Numéro Pièce 5300ES363608THB | Rev. | 4 |
| | 0 | 16 |

This drawing is confidential and must not be reproduced or used without the consent of EXM

Ce dessin est confidentiel et ne doit pas être reproduit ou utilisé sans le consentement de EXM

| STANDARD FEATURES ARE NOT LISTED IN THIS HOLE TABLE | | | |
|--|--------|-------|--------------------------------|
| HOLE TABLE - BOTTOM VIEW (CUSTOM FEATURE ONLY) | | | |
| CUT-OUT | XDIM | YDIM | DESCRIPTION |
| 1 | 2.000 | 6.500 | INSUL. STUD M6 x 18mm (Inside) |
| 2 | 34.000 | 6.500 | INSUL. STUD M6 x 18mm (Inside) |

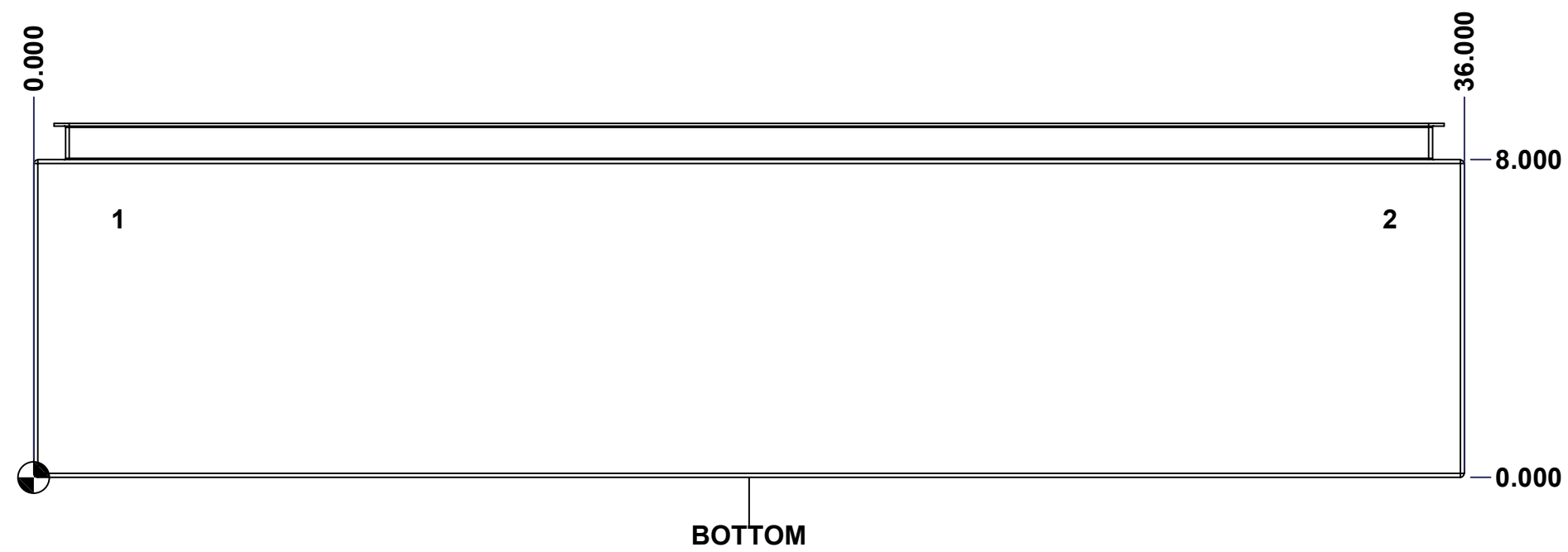

| | | |
|---|----------------------------|--------|
| | Description | Status |
| | 5300ES 36" x 36" x 8" Body | (NULL) |
| Part Number Numéro Pièce 5300ES363608THB | Rev. | 5 |
| | 0 | 16 |

This drawing is confidential and must not be reproduced or used without the consent of EXM

Ce dessin est confidentiel et ne doit pas être reproduit ou utilisé sans le consentement de EXM

STANDARD FEATURES ARE NOT LISTED IN THIS HOLE TABLE

HOLE TABLE - BACK VIEW (CUSTOM FEATURE ONLY)

| CUT-OUT | XDIM | YDIM | DESCRIPTION |
|---------|--------|--------|----------------------------|
| 1 | 1.875 | 1.875 | IP STUD M8 x 35mm (Inside) |
| 2 | 1.875 | 34.125 | IP STUD M8 x 35mm (Inside) |
| 3 | 34.125 | 34.125 | IP STUD M8 x 35mm (Inside) |
| 4 | 34.125 | 1.875 | IP STUD M8 x 35mm (Inside) |
| 5 | 1.875 | 18.000 | IP STUD M8 x 35mm (Inside) |
| 6 | 34.125 | 18.000 | IP STUD M8 x 35mm (Inside) |
| 7 | 18.000 | 1.875 | IP STUD M8 x 35mm (Inside) |
| 8 | 18.000 | 34.125 | IP STUD M8 x 35mm (Inside) |
| ----- | | | |
| 9 | 35.250 | 0.000 | FOOT 885 ESMF3_OPEN |
| 10 | 0.750 | 0.000 | FOOT 885 ESMF3_OPEN |
| 11 | 35.250 | 36.000 | FOOT 885 ESMF3_CLOSE |
| 12 | 0.750 | 36.000 | FOOT 885 ESMF3_CLOSE |

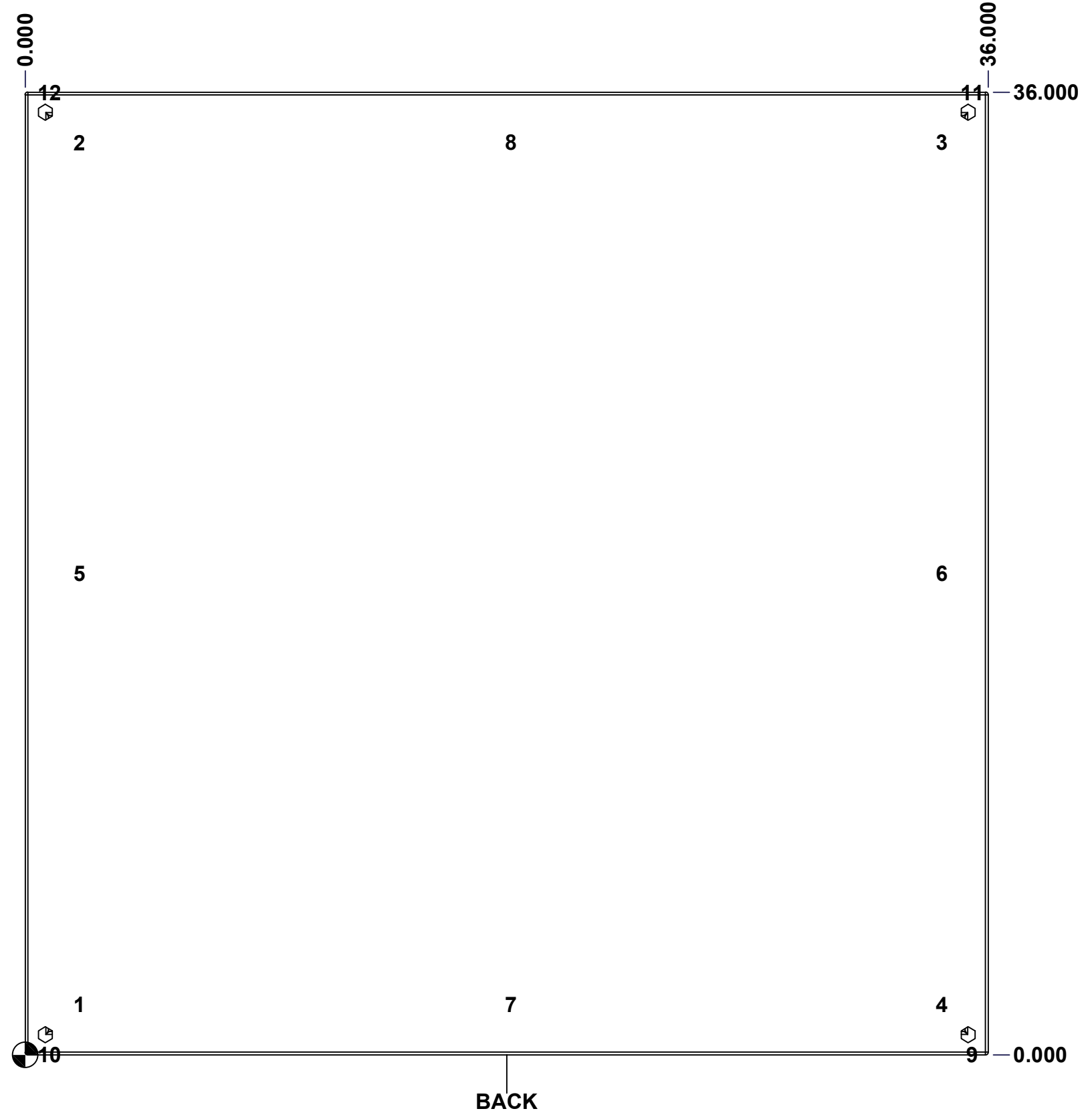

BACK

| | | |
|---|----------------------------|--------|
| | Description | Status |
| | 5300ES 36" x 36" x 8" Body | (NULL) |
| Part Number Numéro Pièce 5300ES363608THB | Rev. | 6 |
| | 0 | 16 |

This drawing is confidential and must not be reproduced or used without the consent of EXM

Ce dessin est confidentiel et ne doit pas être reproduit ou utilisé sans le consentement de EXM

| No. | Revisions | Date | By/Par |
|-----|-----------|------|--------|
| | | | |
| | | | |
| | | | |
| | | | |
| | | | |

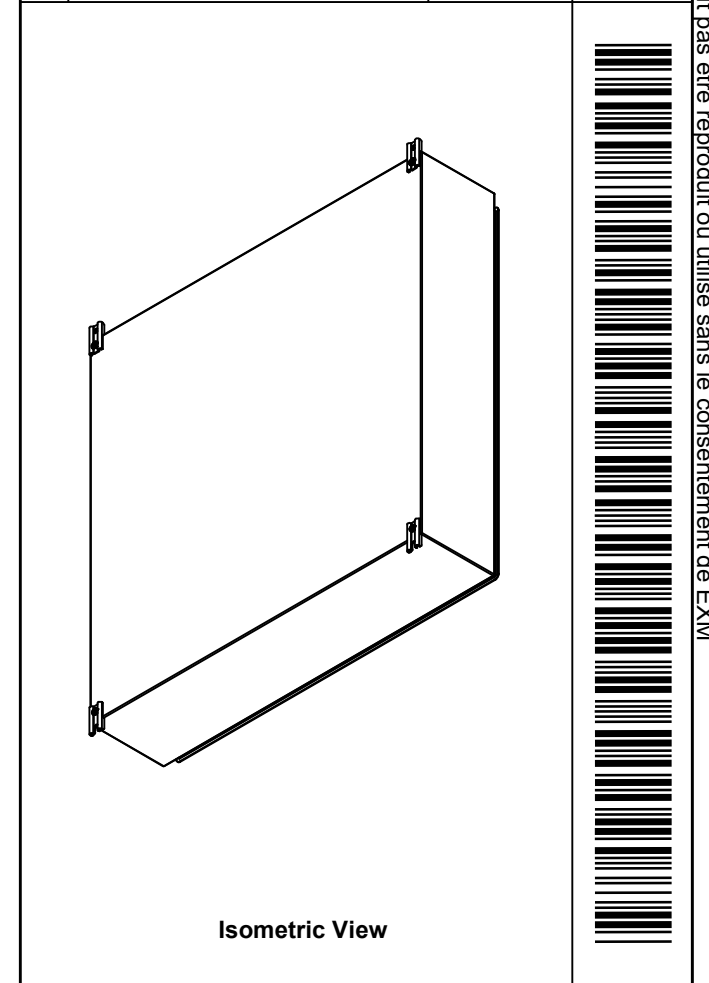

Isometric View

| | | | |
|---|---------------------|---|--|
| 1 | 885 ESMF3 | 0 | 885 ESMF3 Mounting Foot Kit |
| 4 | RIVET_NUT_M10_FH_CE | 0 | Rivet Nut M10 (Low Profile Close End) |
| 1 | STK-K-70554 | 3 | 5412 ESTH Accessory Kit |
| 1 | 5300ES363608THI-RS | 0 | 5300ES 36" x 36" Right Insulation |
| 1 | 5300ES363608THI-LS | 0 | 5300ES 36" x 36" Left Insulation |
| 1 | 5300ES363608THI-BT | 0 | 5300ES 36" x 36"Bottom Insulation |
| 1 | 5300ES363608THI-TP | 0 | 5300ES 36" x 36"Top Insulation |
| 1 | 5300ES363608THI-B | 0 | 5300ES 36" x 36" Back Insulation |
| 4 | STK-Q-16055 | 1 | M6 x 18mm Stud (No Paint Cap Required) |
| 1 | STK-P-02400S | 0 | Powder Paint (Asa-61 Grey / Smooth) |
| 8 | STK-Q-16005 | 0 | Stud M8 x 35mm Steel |
| 1 | 5300ES363608THB-P | 0 | 5300ES 36" x 36" x 8" Body Part |

| Qty | Part Number | Rev | Description |
|------------|-------------|-----|-------------|
| Parts List | | | |

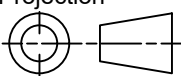
| | | |
|--|-----------------------|--|
|  Tél: (450) 979-4373 Fax: (450) 979-4626 www.exmweb.com | | Flatness Aplatissement Max 3.0mm |
| Projection  | | Customer Client |
| Drawn By Dessiné Par BoxCad: BoxCad | | Date 16-Dec-24 |
| Material Matière 14 Ga Cold Rolled A1008 CS Type B (1.7mm) | | |
| Color Couleur Asa-61 Grey | Finish Fini Smooth | |
| Description 5300ES 36" x 36" x 8" Body | | Detail Rev. |
| Part Number Numéro Pièce 5300ES363608THB | | Rev. 7 0 |

This drawing is confidential and must not be reproduced or used without the consent of EXM

Ce dessin est confidentiel et ne doit pas être reproduit ou utilisé sans le consentement de EXM

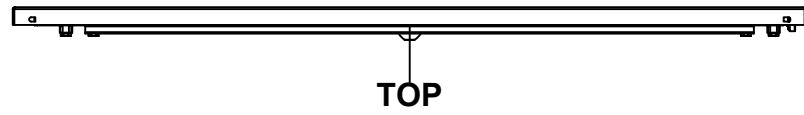

TOP

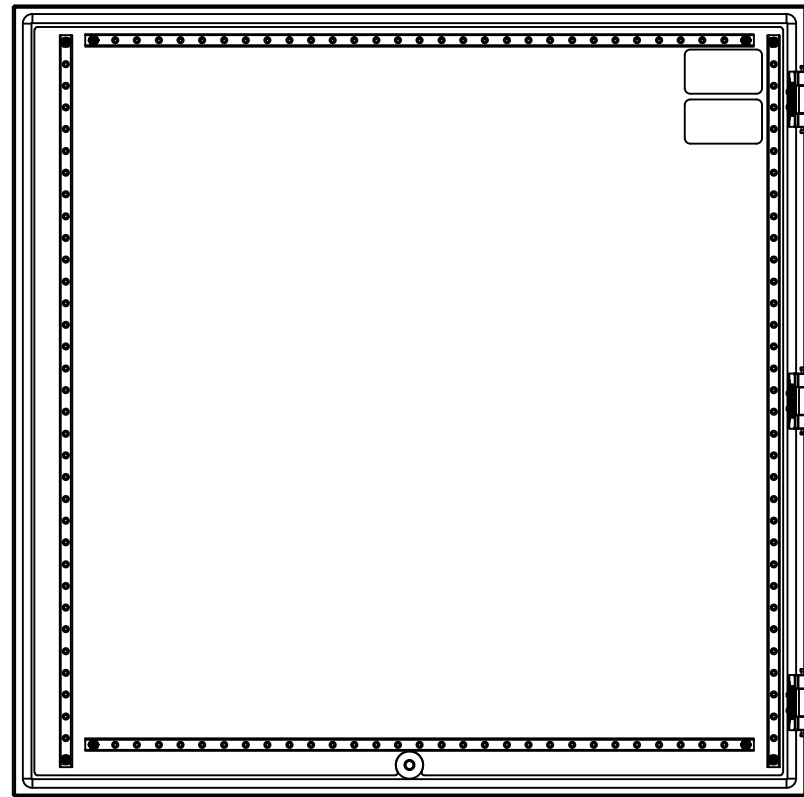

BACK

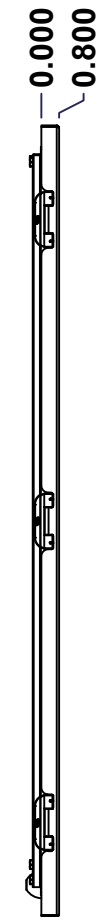

LEFT

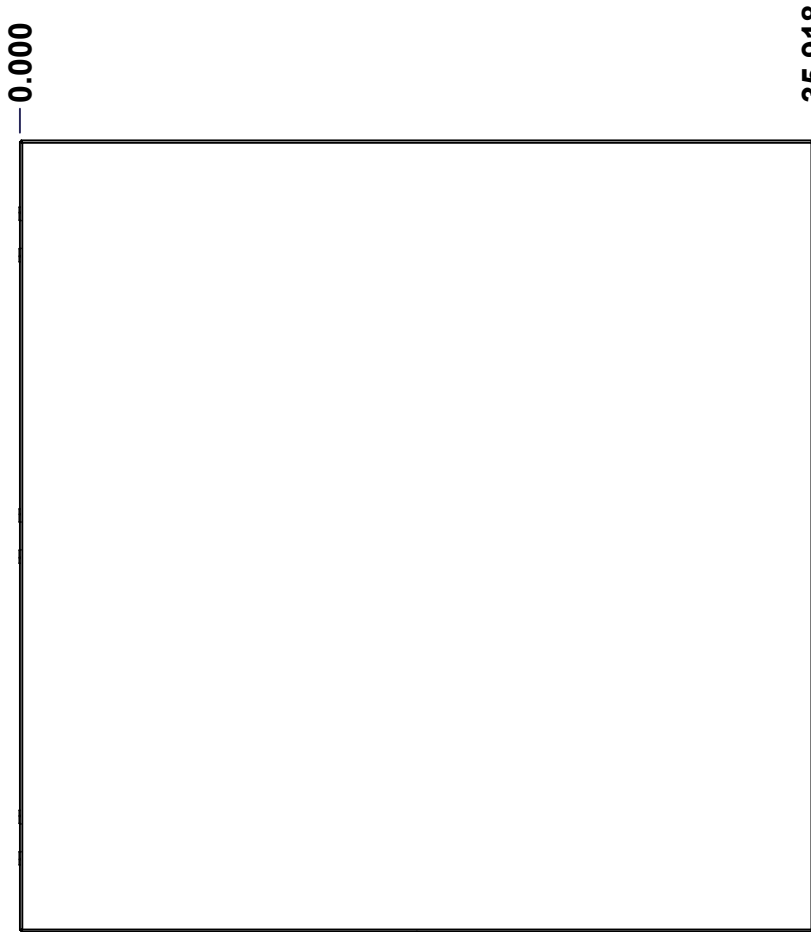

FRONT

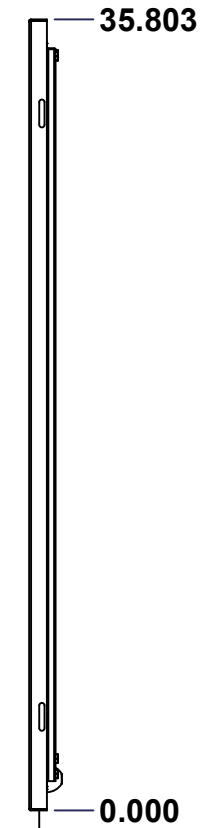

RIGHT



BOTTOM

| No. | Revisions | Date | By/Par |
|-----|-----------|------|--------|
| | | | |
| | | | |
| | | | |
| | | | |

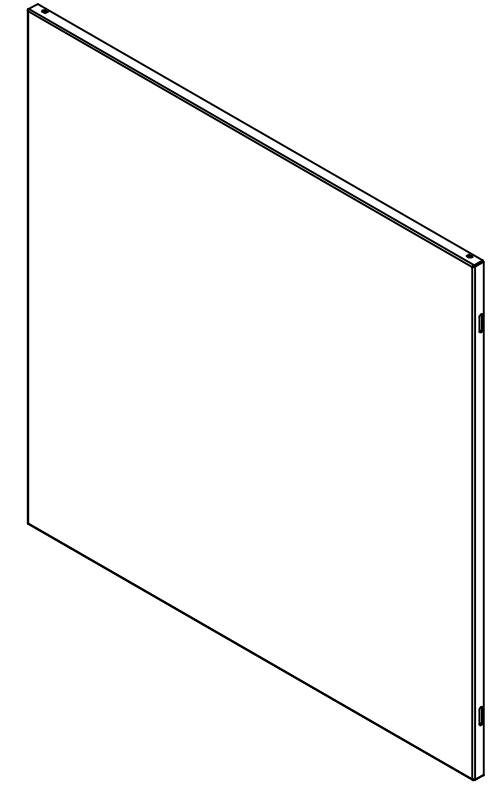

Isometric View



Tél: (450) 979-4373
 Fax: (450) 979-4626
www.exmweb.com

Flatness
Aplatissement

Max 3.0mm

Projection

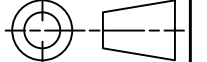

| | |
|---|-----------------|
| Customer Client | Date |
| Drawn By / Dessiné Par: BoxCad: BoxCad | Date: 16-Dec-24 |
| Material / Matière: 14 Ga Cold Rolled A1008 CS Type B (1.7mm) | |

| | |
|------------------------------|-----------------------|
| Color / Couleur: Asa-61 Grey | Finish / Fini: Smooth |
|------------------------------|-----------------------|

| | |
|-------------------------------------|-------------|
| Description: 5300ES 36" x 36" Cover | Detail Rev. |
|-------------------------------------|-------------|

| | | |
|---|--------|---|
| Part Number / Numéro Pièce: 5300ES363608THC | Rev. 0 | 8 |
|---|--------|---|

SEE BILL OF MATERIAL ON LAST PAGE

This drawing is confidential and must not be reproduced or used without the consent of EXM

Ce dessin est confidentiel et ne doit pas être reproduit ou utilisé sans le consentement de EXM

| STANDARD FEATURES ARE NOT LISTED IN THIS HOLE TABLE | | | |
|---|--------|--------|-------------------------|
| HOLE TABLE - FRONT VIEW (CUSTOM FEATURE ONLY) | | | |
| CUT-OUT | XDIM | YDIM | DESCRIPTION |
| 1 | 1.486 | 1.661 | STUD M6 x 18mm (Inside) |
| 2 | 1.486 | 34.142 | STUD M6 x 18mm (Inside) |
| 3 | 33.517 | 34.142 | STUD M6 x 18mm (Inside) |
| 4 | 33.517 | 1.661 | STUD M6 x 18mm (Inside) |
| 5 | 2.738 | 2.350 | STUD M6 x 18mm (Inside) |
| 6 | 2.738 | 34.228 | STUD M6 x 18mm (Inside) |
| 7 | 32.265 | 34.228 | STUD M6 x 18mm (Inside) |
| 8 | 32.265 | 2.350 | STUD M6 x 18mm (Inside) |
| 9 | 17.959 | 1.435 | STUD M6 x 18mm (Inside) |

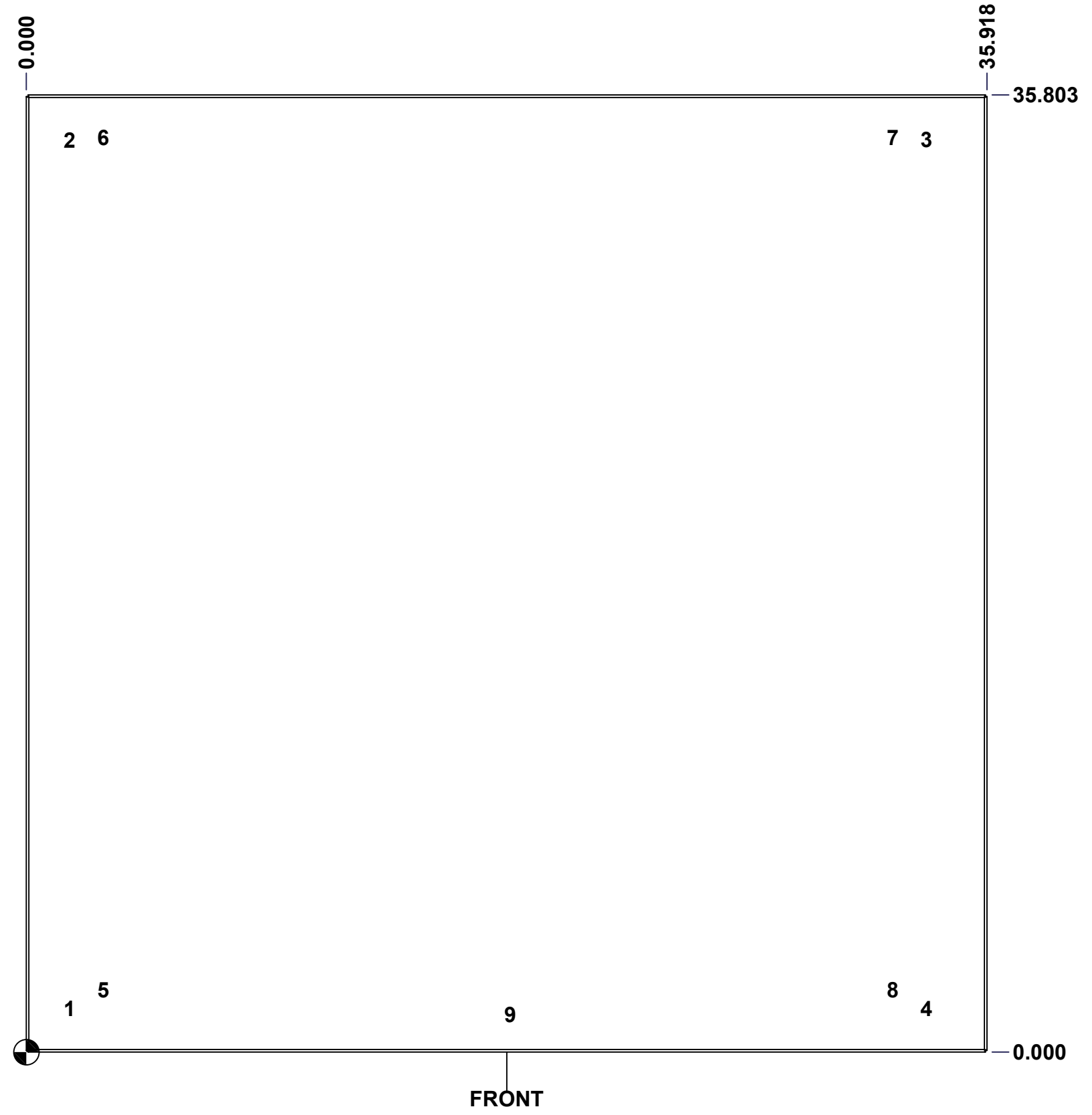

| | | |
|---|------------------------|--------|
| | Description | Status |
| | 5300ES 36" x 36" Cover | (NULL) |
| Part Number Numéro Pièce 5300ES363608THC | Rev. | 9 |
| | 0 | 16 |

This drawing is confidential and must not be reproduced or used without the consent of EXM

Ce dessin est confidentiel et ne doit pas être reproduit ou utilisé sans le consentement de EXM

| No. | Revisions | Date | By/Par |
|-----|-----------|------|--------|
| | | | |
| | | | |
| | | | |
| | | | |
| | | | |

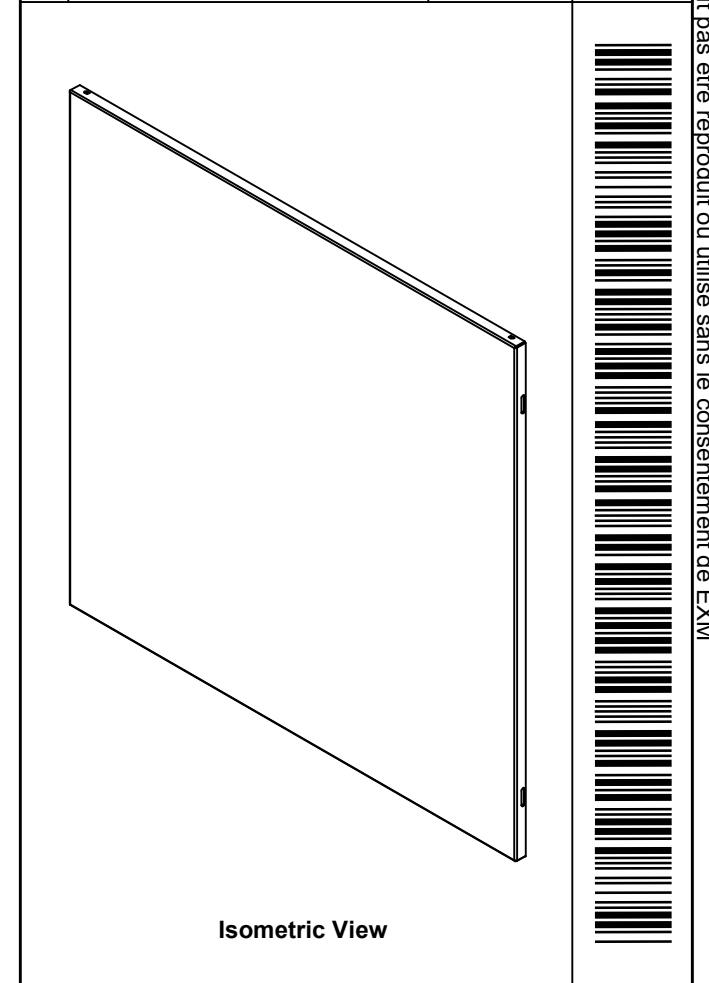

 Tél: (450) 979-4373
 Fax: (450) 979-4626
www.exmweb.com

Flatness
Aplatissement

 Max 3.0mm
Projection

| 2 | STK-S-00100 | 0 | 3.5" x 2" Silver Milar Flexcon Sticker |
|------------|-------------------|-----|---|
| 8 | STK-Q-07250 | 2 | M6 x 16mm Collar Nut |
| 2 | STK-Q-46025-36-3 | 6 | 5412 ES Horizontal Door Stiffener 36" (3 Pts) |
| 2 | STK-Q-46020-36 | 5 | 5412 ES Vertical Door Stiffener 36" |
| 1 | 5300ES363608THI-C | 0 | 5300ES 36" x 36" Cover Insulation |
| 1 | STK-P-02400S | 0 | Powder Paint (Asa-61 Grey / Smooth) |
| 1 | STK-Q-46515 | 3 | 5412 ES Door Support with Brass Insert |
| 9 | STK-Q-16055 | 1 | M6 x 18mm Stud (No Paint Cap Required) |
| 1 | 5300ES363608THG | 0 | 5300ES 36" x 36" Cover Gasket Part |
| 1 | 5300ES363608THC-P | 0 | 5300ES 36" x 36" Cover Part |
| 3 | STK-K-09800 | 10 | 5412 ES Hinge with 2 Captive Hinge Pins |
| QTY | Part Number | Rev | Description |
| Parts List | | | |

| | |
|---|------------------------|
| Customer Client | Date |
| Drawn By Dessiné Par BoxCad: BoxCad | Date 16-Dec-24 |
| Material Matière 14 Ga Cold Rolled A1008 CS Type B (1.7mm) | |
| Color Couleur Asa-61 Grey | Finish Fini Smooth |
| Description 5300ES 36" x 36" Cover | Detail Rev. |
| Part Number Numéro Pièce 5300ES363608THC | Rev. 10 0 16 |

This drawing is confidential and must not be reproduced or used without the consent of EXM

Ce dessin est confidentiel et ne doit pas être reproduit ou utilisé sans le consentement de EXM

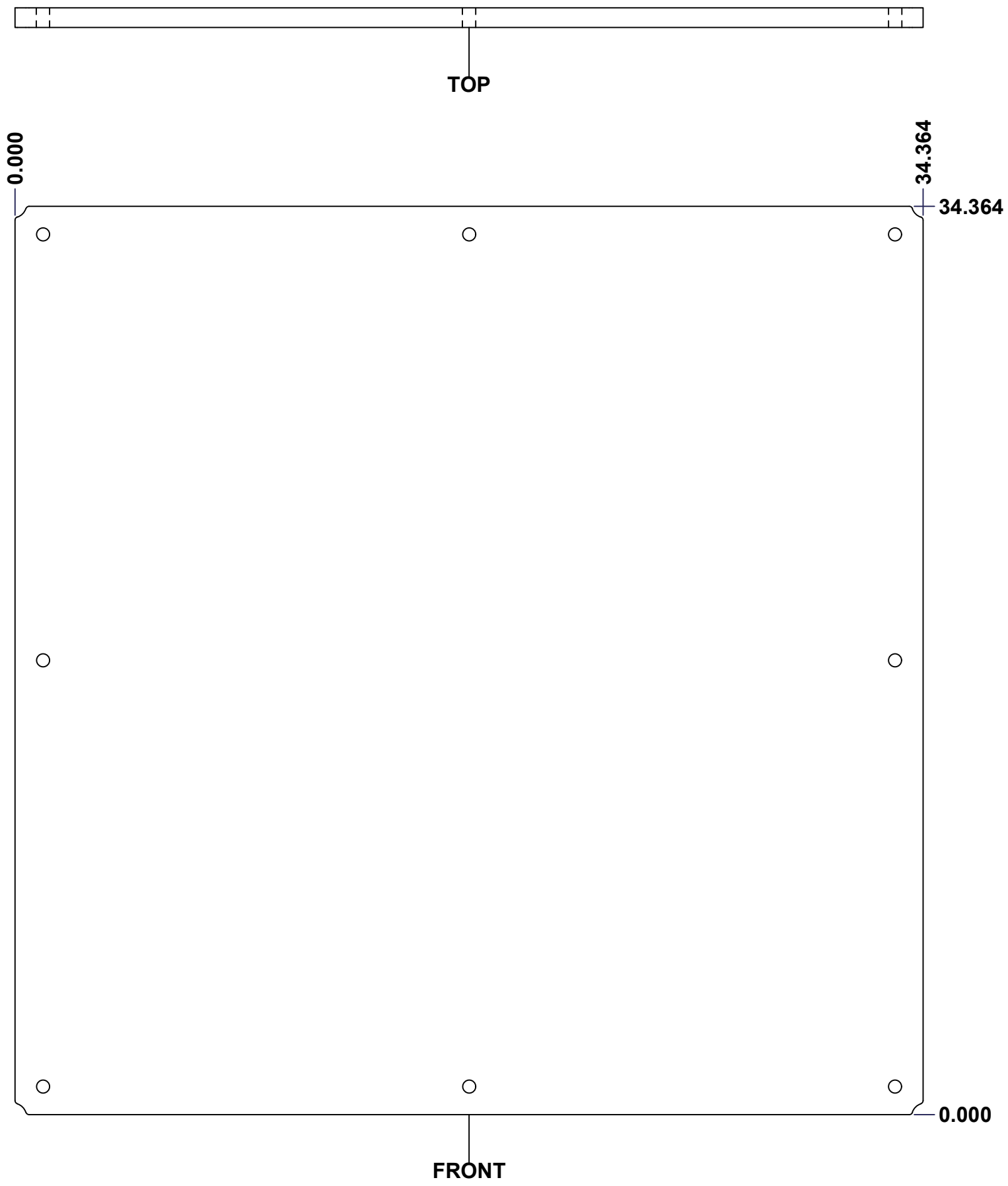

| No. | Revisions | Date | By/Par |
|-----|-----------|------|--------|
| | | | |
| | | | |
| | | | |
| | | | |
| | | | |

Isometric View

| | | |
|--|----------------------------------|--|
| Tél: (450) 979-4373 Fax: (450) 979-4626 www.exmweb.com | | Flatness Aplatissement Max 3.0mm |
| Projection | | Date |
| Customer Client | BoxCad: Patrick Deschenes | Date 23-Jan-07 |
| Material Matière | Polyisocyanurate | |
| Color Couleur | Aluminum | Finish Fini N/A |
| Description | 5300ES 36" x 36" Back Insulation | |
| Part Number Numéro Pièce | Rev. 0 | 11 / 16 |

SEE BILL OF MATERIAL ON LAST PAGE

This drawing is confidential and must not be reproduced or used without the consent of EXM

Ce dessin est confidentiel et ne doit pas être reproduit ou utilisé sans le consentement de EXM

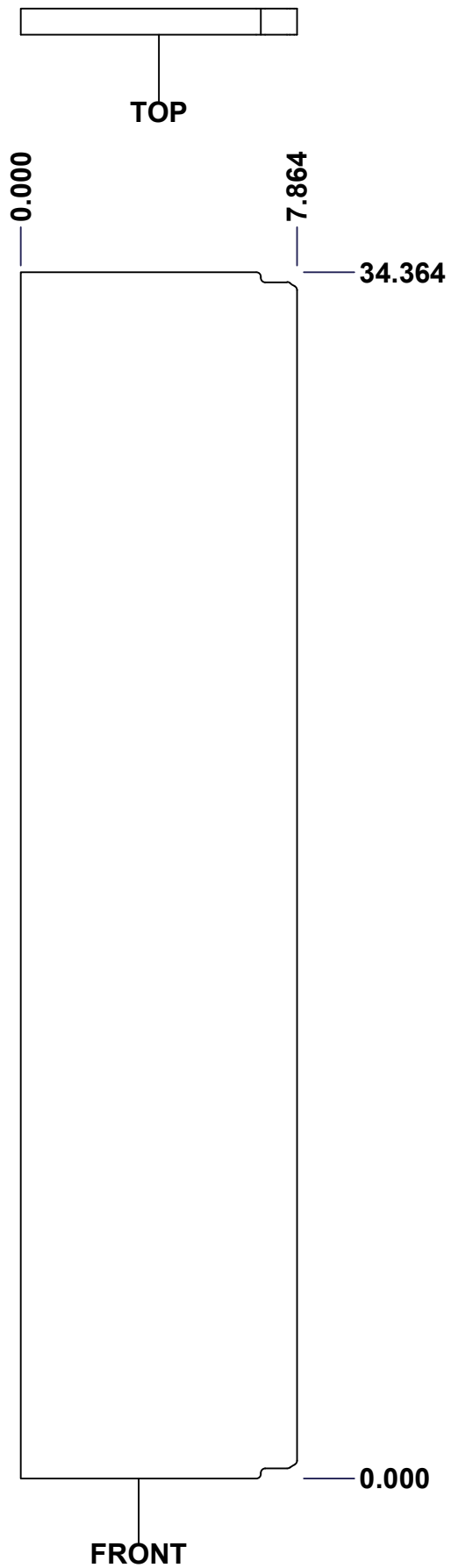

0.000
0.750

| No. | Revisions | Date | By/Par |
|-----|-----------|------|--------|
| | | | |
| | | | |
| | | | |
| | | | |
| | | | |

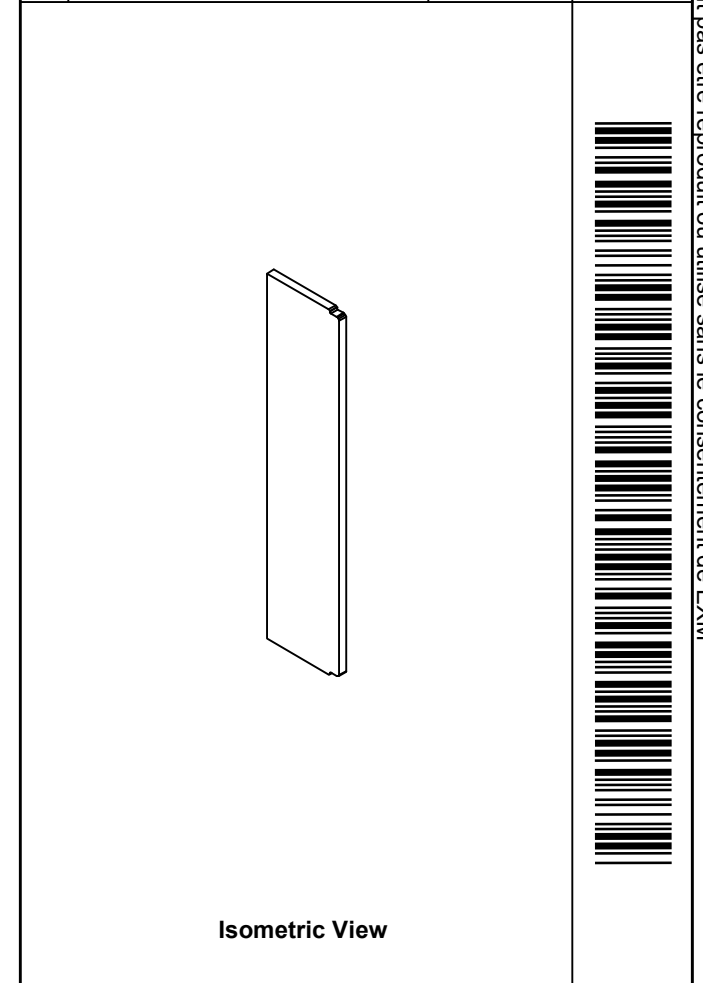

Isometric View

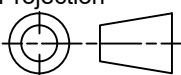
| | | |
|--|---------------------------|--|
|  Tél: (450) 979-4373 Fax: (450) 979-4626 www.exmweb.com | | Flatness Aplatissement Max 3.0mm |
| Projection  | | Date |
| Customer Client | BoxCad: Patrick Deschenes | Date 23-Jan-07 |
| Material Matière | Polyisocyanurate | |
| Color Couleur | Aluminum | Finish Fini N/A |
| Description 5300ES 36" x 36" Left Insulation | | Detail Rev. |
| Part Number Numéro Pièce | Rev. 0 | 12 / 16 |

SEE BILL OF MATERIAL ON LAST PAGE

This drawing is confidential and must not be reproduced or used without the consent of EXM

Ce dessin est confidentiel et ne doit pas être reproduit ou utilisé sans le consentement de EXM

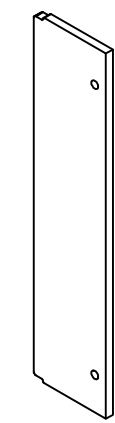
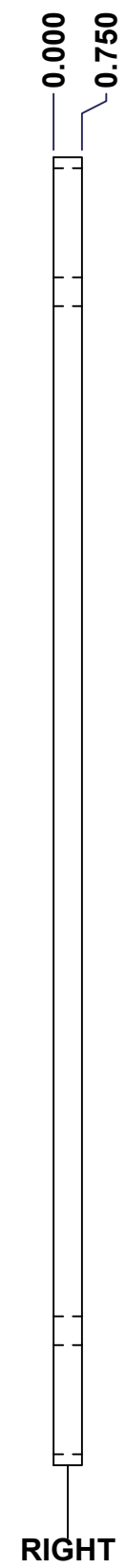
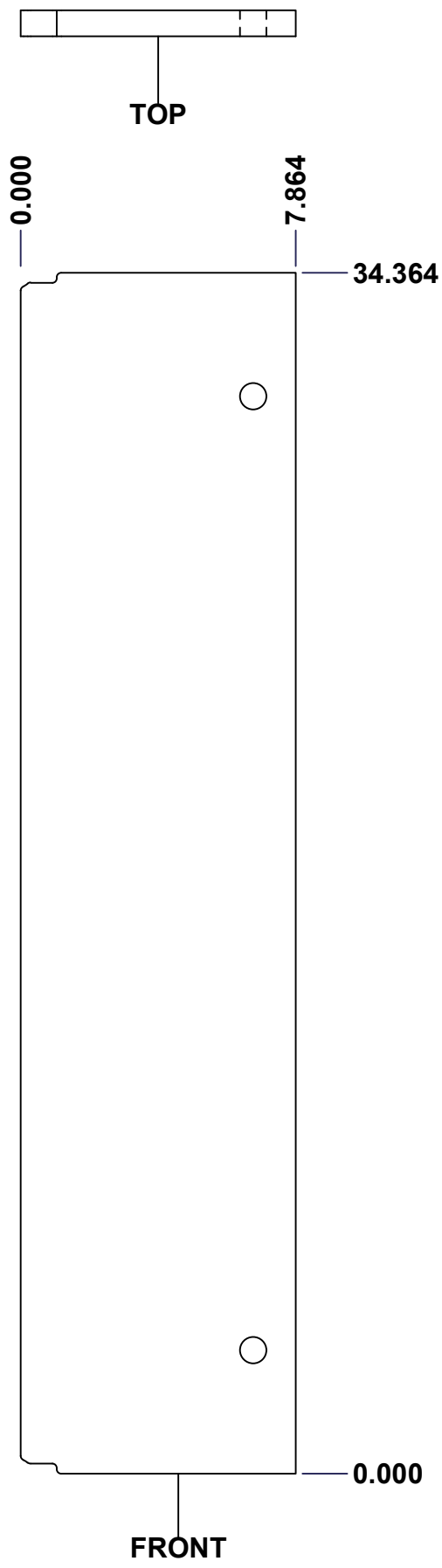

Isometric View

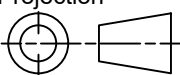

| No. | Revisions | Date | By/Par |
|-----|-----------|------|--------|
| | | | |
| | | | |
| | | | |
| | | | |
| | | | |

| | | |
|--|--------------------|---|
|  Tél: (450) 979-4373 Fax: (450) 979-4626 www.exmweb.com | | Flatness Aplatissement Max 3.0mm Projection  |
| Customer Client | Date | |
| Drawn By / Dessiné Par: BoxCad: Patrick Deschenes | Date: 23-Jan-07 | |
| Material / Matière: Polyisocyanurate | | |
| Color / Couleur: Aluminum | Finish / Fini: N/A | |
| Description: 5300ES 36" x 36" Right Insulation | | Detail Rev. |
| Part Number / Numéro Pièce: 5300ES363608THI-RS | Rev. 0 | 13 / 16 |

SEE BILL OF MATERIAL ON LAST PAGE

This drawing is confidential and must not be reproduced or used without the consent of EXM

Ce dessin est confidentiel et ne doit pas être reproduit ou utilisé sans le consentement de EXM

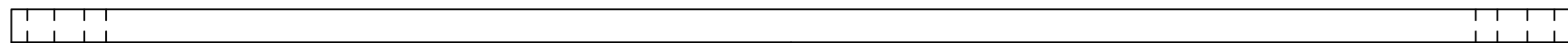

TOP



FRONT

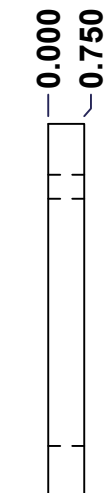

RIGHT

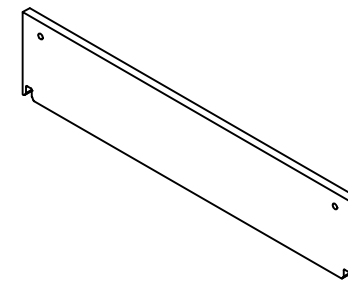

Isometric View

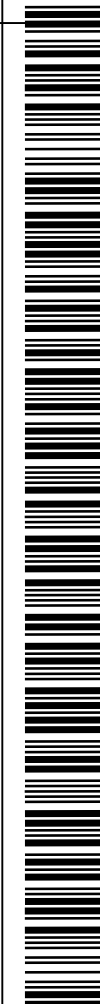

| No. | Revisions | Date | By/Par |
|-----|-----------|------|--------|
| | | | |
| | | | |
| | | | |
| | | | |

| | | |
|--|-----------------------|--|
|  Tél: (450) 979-4373 Fax: (450) 979-4626 www.exmweb.com | | Flatness Aplatissement Max 3.0mm |
| Customer Client | | Date |
| Drawn By / Dessiné Par: BoxCad: BoxCad | | Date: 4/3/2024 |
| Material / Matière: Polyisocyanurate | | |
| Color / Couleur: Aluminum | Finish / Fini: Smooth | |
| Description: 5300ES 36" x 36" Top Insulation | | Detail Rev. |
| Part Number / Numéro Pièce: 5300ES363608THI-TP | | Rev. 14 0 |

SEE BILL OF MATERIAL ON LAST PAGE

This drawing is confidential and must not be reproduced or used without the consent of EXM

Ce dessin est confidentiel et ne doit pas être reproduit ou utilisé sans le consentement de EXM

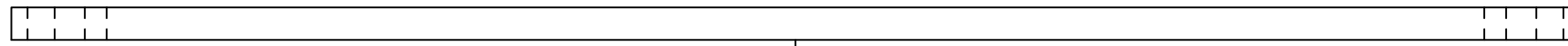

TOP

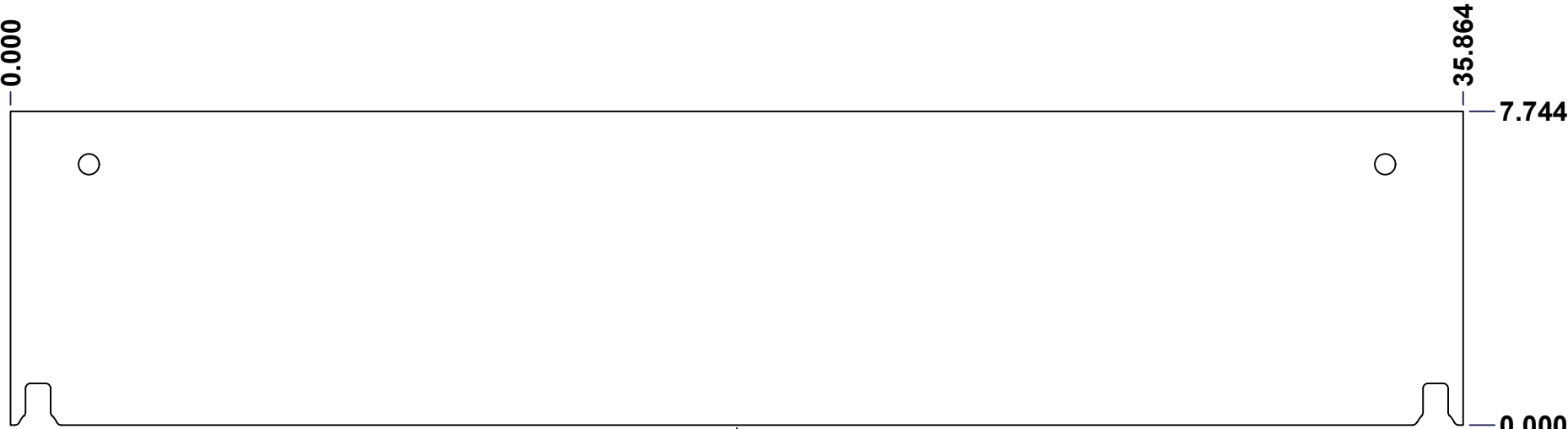

FRONT

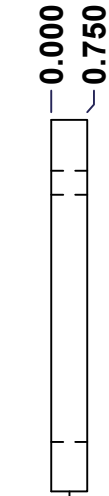

RIGHT

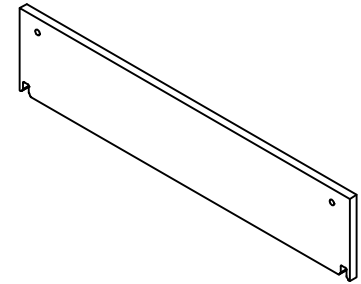

Isometric View



| No. | Revisions | Date | By/Par |
|-----|-----------|------|--------|
| | | | |
| | | | |
| | | | |
| | | | |
| | | | |

| | | |
|--|-----------------------|--|
|  Tél: (450) 979-4373 Fax: (450) 979-4626 www.exmweb.com | | Flatness Aplatissement Max 3.0mm |
| Customer Client | | Date |
| Drawn By / Dessiné Par: BoxCad: BoxCad | | Date: 4/3/2024 |
| Material / Matière: Polyisocyanurate | | |
| Color / Couleur: Aluminum | Finish / Fini: Smooth | |
| Description: 5300ES 36" x 36" Bottom Insulation | | Detail Rev. |
| Part Number / Numéro Pièce: 5300ES363608THI-BT | | Rev. 15 0 |

SEE BILL OF MATERIAL ON LAST PAGE

This drawing is confidential and must not be reproduced or used without the consent of EXM

Ce dessin est confidentiel et ne doit pas être reproduit ou utilisé sans le consentement de EXM

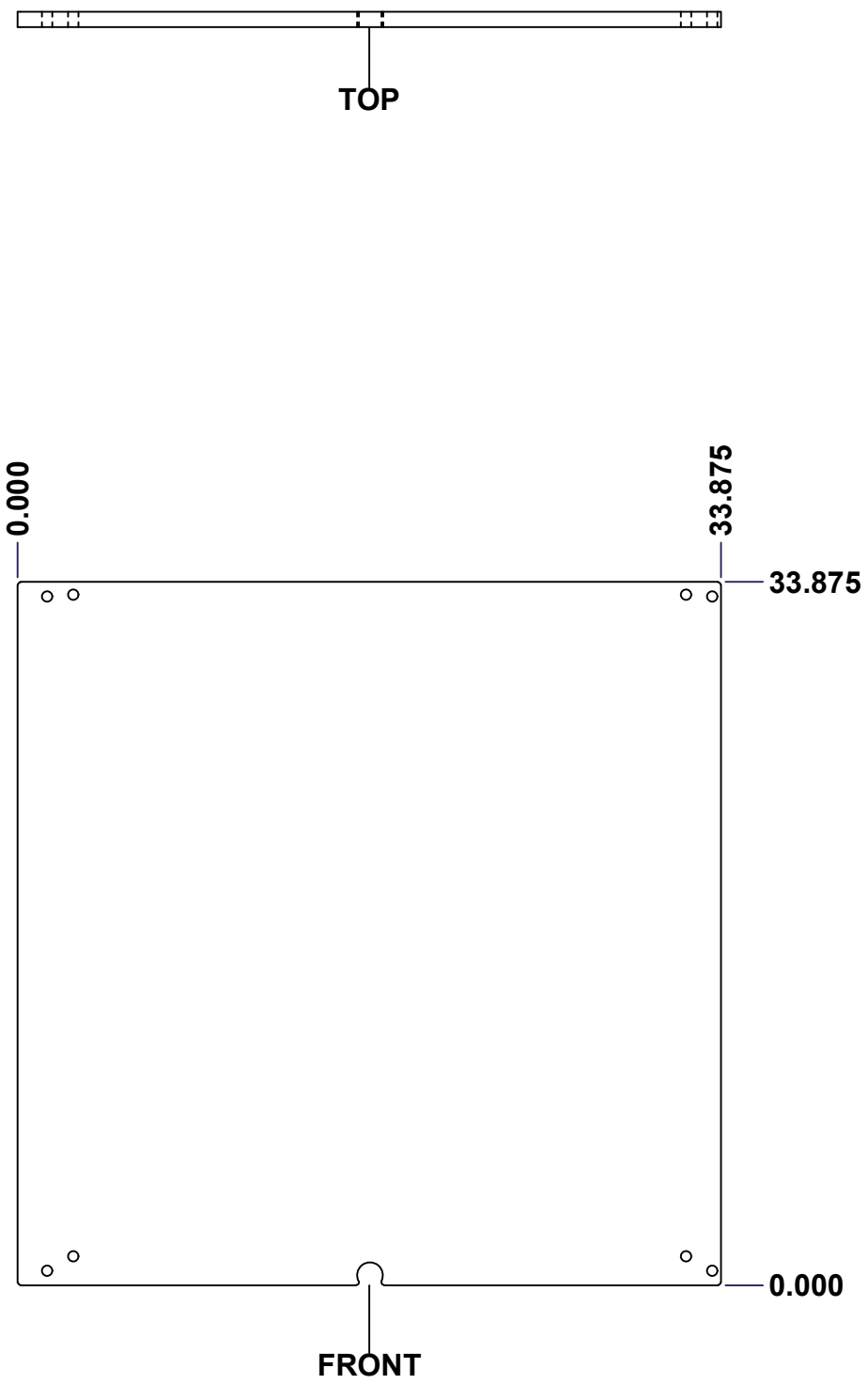

| No. | Revisions | Date | By/Par |
|-----|-----------|------|--------|
| | | | |
| | | | |
| | | | |
| | | | |

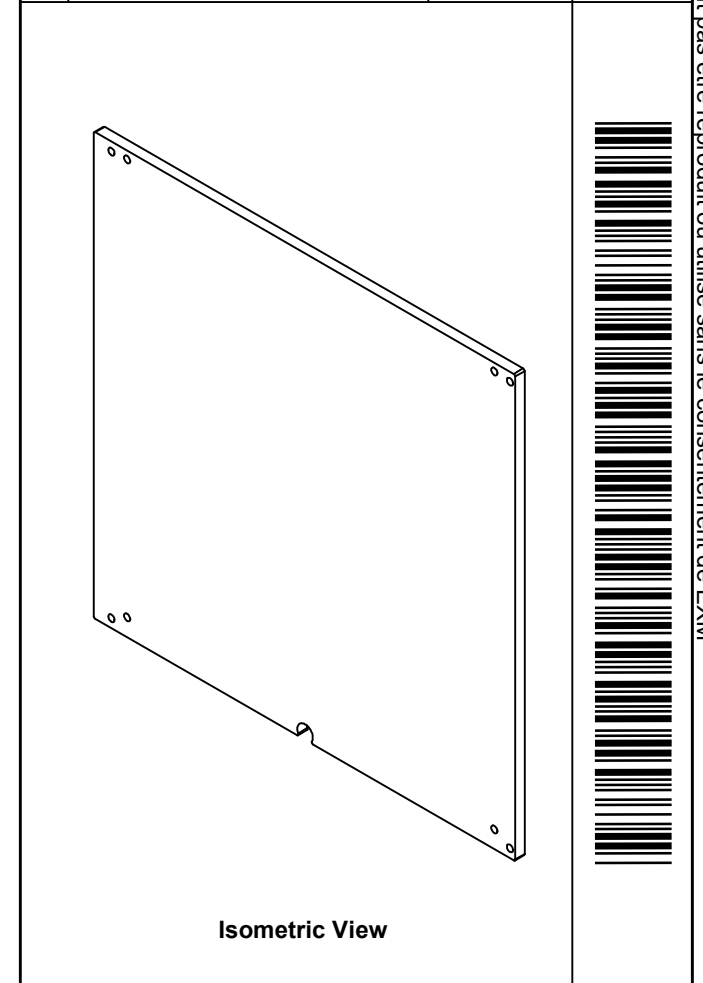

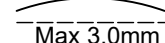
| | | |
|--|--------------------|---|
|  Tél: (450) 979-4373 Fax: (450) 979-4626 www.exmweb.com | | Flatness Aplatissement  Max 3.0mm |
| Customer Client | | Date |
| Drawn By Dessiné Par BoxCad: Patrick Deschenes | | Date 23-Jan-07 |
| Material Matière Polyisocyanurate | | |
| Color Couleur Aluminum | Finish Fini N/A | |
| Description 5300ES 36" x 36" Cover Insulation | | Detail Rev. |
| Part Number Numéro Pièce 5300ES363608THI-C | | Rev. 16 0 |

SEE BILL OF MATERIAL ON LAST PAGE

This drawing is confidential and must not be reproduced or used without the consent of EXM

Ce dessin est confidentiel et ne doit pas être reproduit ou utilisé sans le consentement de EXM

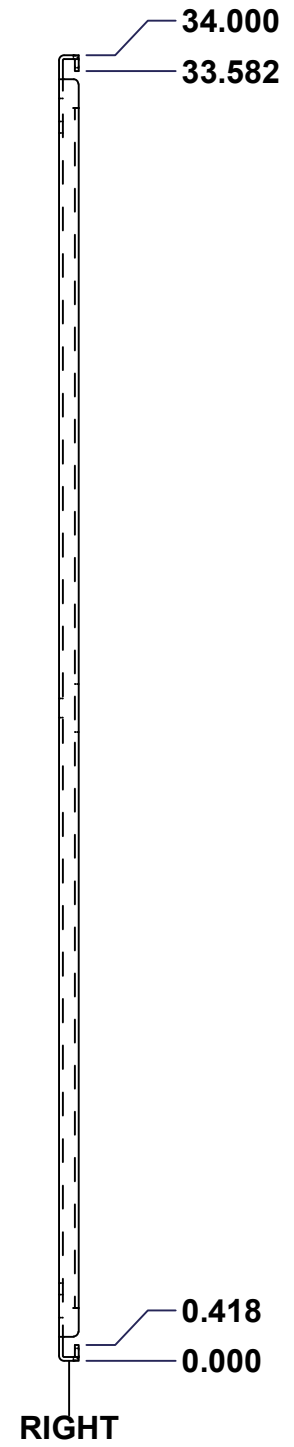
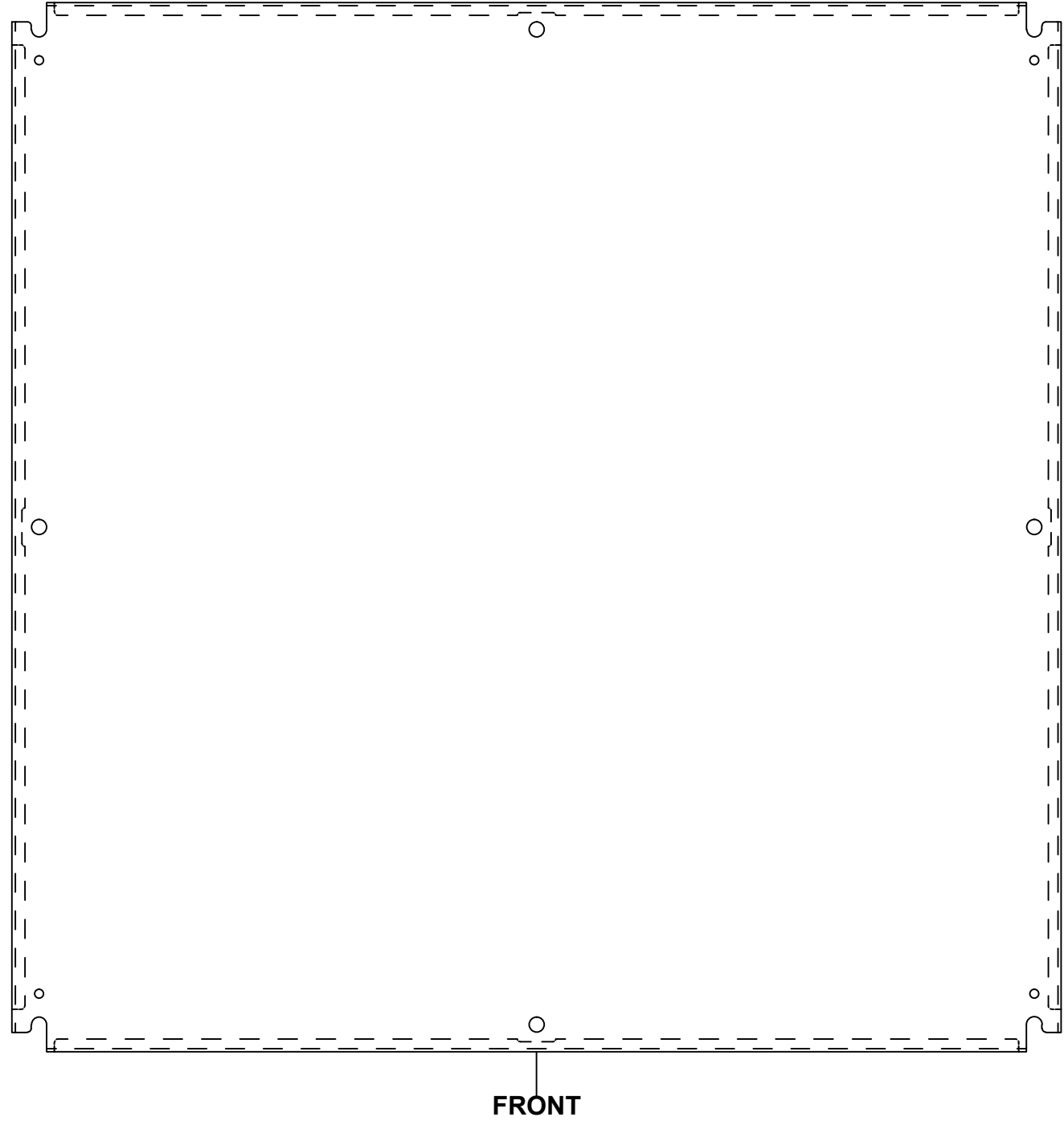
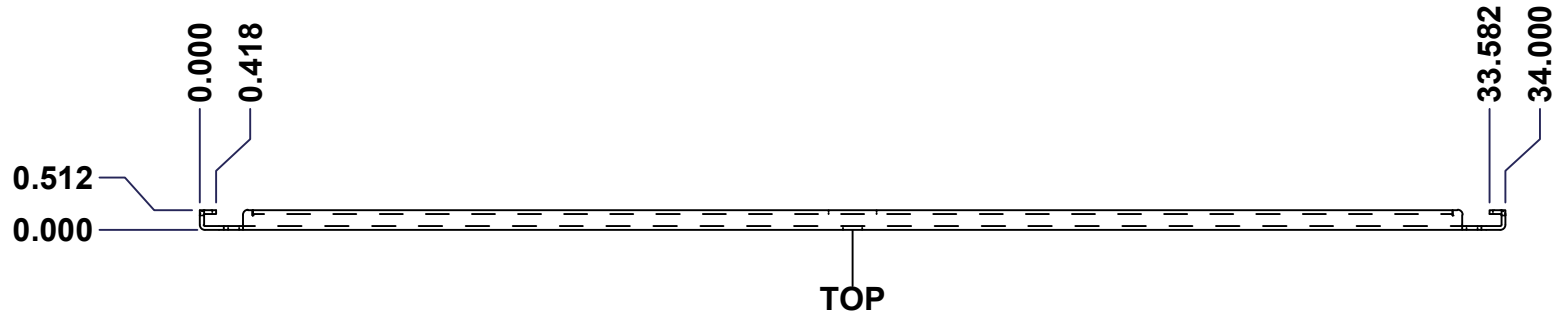

| No. | Revisions | Date | By/Par |
|-----|-----------|------|--------|
| | | | |
| | | | |
| | | | |
| | | | |
| | | | |

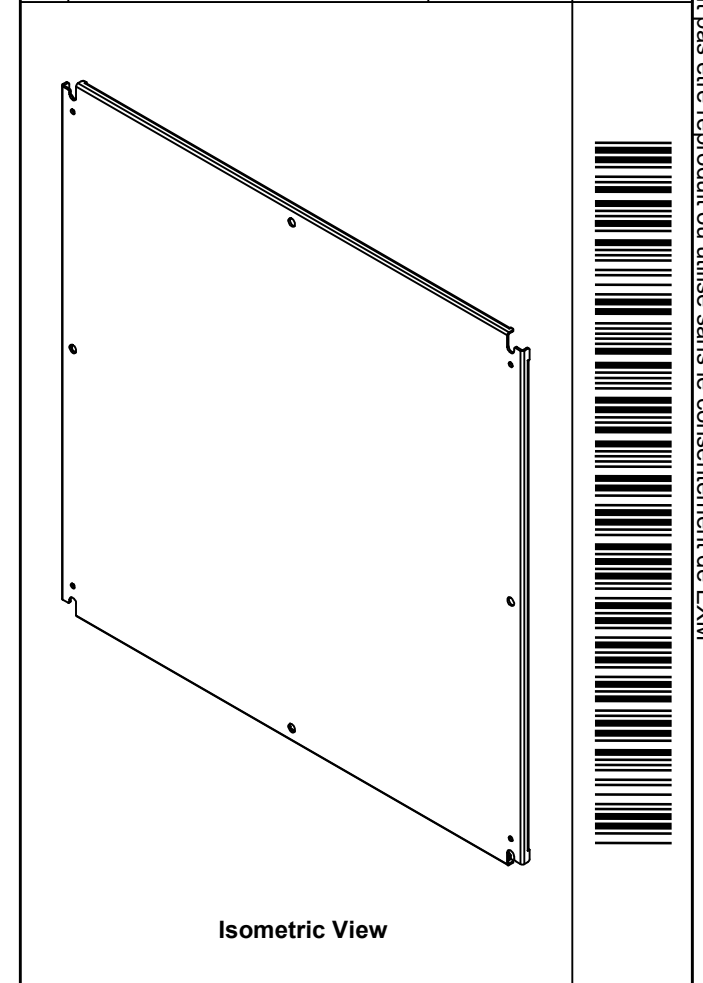

| | |
|---|---|
| <p>Tél: (450) 979-4373 Fax: (450) 979-4626 www.exmweb.com</p> | <p>Flatness Aplatissement Max 3.0mm</p> |
| | <p>Projection</p> |
| Customer Client | Date |
| Drawn By Dessiné Par BoxCad | Date 23-Jan-07 |
| Material Matière | See Part List |
| Color Couleur | See Part List |
| Finish Fini | See Part List |
| Description | Detail Rev. |
| 881 SP - Inner Panel | |
| Part Number Numéro Pièce | Rev. 1 |
| 881 SP3636G | 0 2 |

| Qty | Part Number | Rev | Description | Material | Color | Finish |
|-----|---------------|-----|---------------------------|------------------|-----------|------------|
| 1 | 881 SP3636G-P | 0 | 881 SP - Inner Panel Part | 12 Ga Galvanized | Unpainted | Galvanized |

Parts List

This drawing is confidential and must not be reproduced or used without the consent of EXM

Ce dessin est confidentiel et ne doit pas être reproduit ou utilisé sans le consentement de EXM

| Table 1 | | | FRONT VIEW |
|---------|--------|--------|----------------------------|
| CUT-OUT | XDIM | YDIM | DESCRIPTION |
| 1 | 17.000 | 0.875 | MTG STUD HOLE (RND Ø0.500) |
| 2 | 0.875 | 17.000 | MTG STUD HOLE (RND Ø0.500) |
| 3 | 33.125 | 17.000 | MTG STUD HOLE (RND Ø0.500) |
| 4 | 17.000 | 33.125 | MTG STUD HOLE (RND Ø0.500) |
| 5 | 0.875 | 1.875 | GROUND HOLE (RND Ø0.290) |
| 6 | 33.125 | 1.875 | GROUND HOLE (RND Ø0.290) |
| 7 | 0.875 | 32.125 | GROUND HOLE (RND Ø0.290) |
| 8 | 33.125 | 32.125 | GROUND HOLE (RND Ø0.290) |

All knockouts are actual size / Les disques défonçables sont grandeur réel

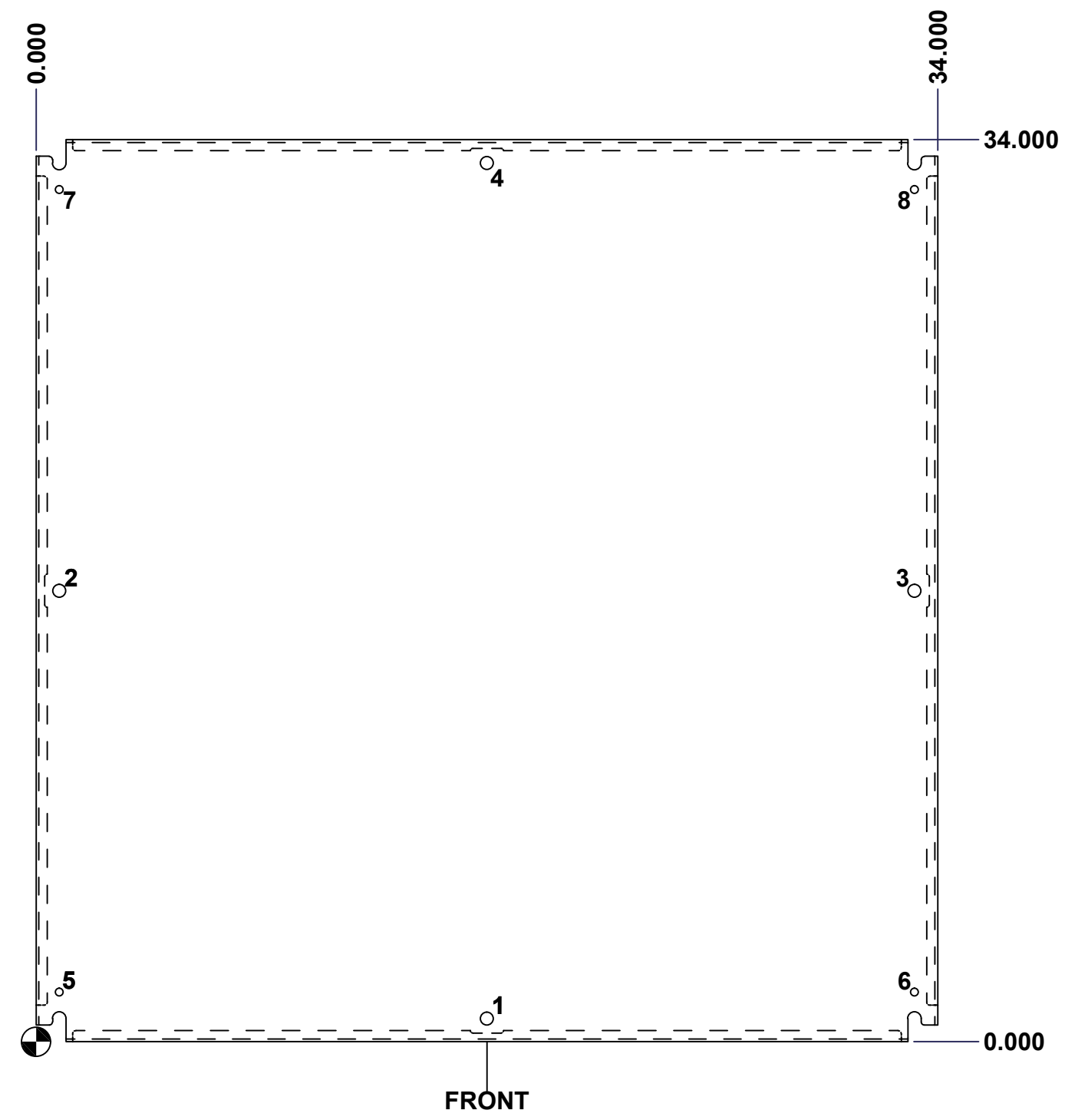

| No. | Revisions | Date | By/Par |
|-----|-----------|------|--------|
| | | | |
| | | | |
| | | | |
| | | | |
| | | | |

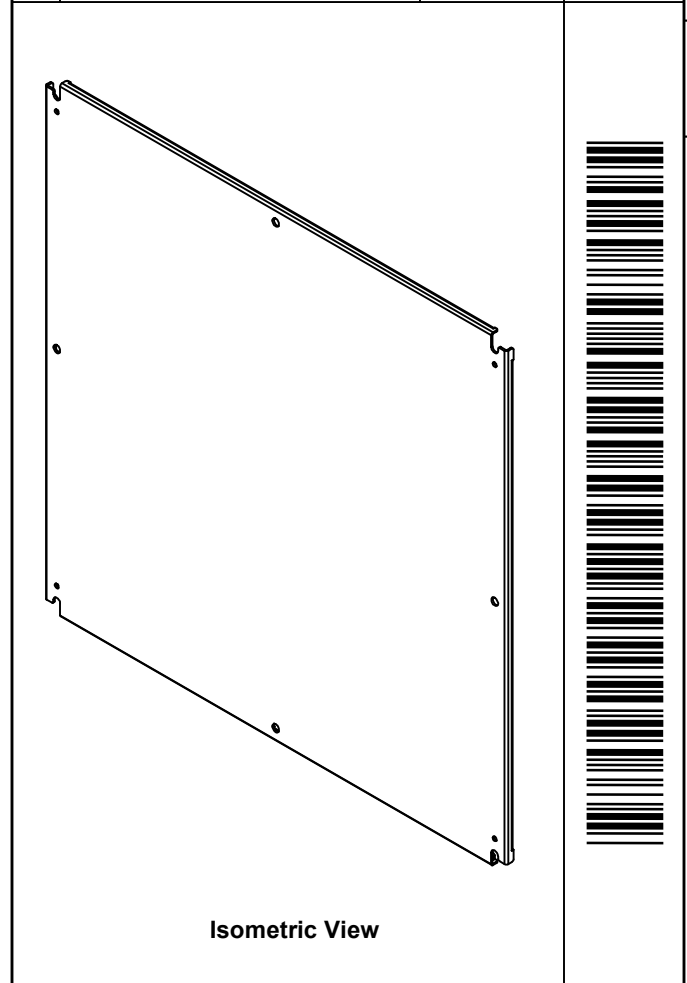

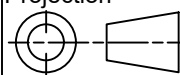
| | | |
|--|---------------|---|
|  Tél: (450) 979-4373 Fax: (450) 979-4626 www.exmweb.com | | Flatness Aplatissement Max 3.0mm Projection  |
| Customer Client | Date | |
| Drawn By Dessiné Par | BoxCad | Date 23-Jan-07 |
| Material Matière | See Part List | |
| Color Couleur | See Part List | Finish Fini See Part List |
| Description 881 SP - Inner Panel | | Detail Rev. |
| Part Number Numéro Pièce | 881 SP3636G | Rev. 2 0 |