

This drawing is confidential and must not be reproduced or used without the consent of EXM

Ce dessin est confidentiel et ne doit pas être reproduit ou utilisé sans le consentement de EXM

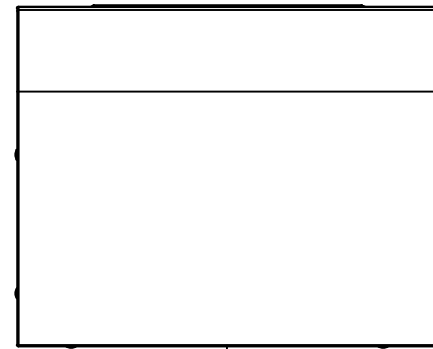

TOP

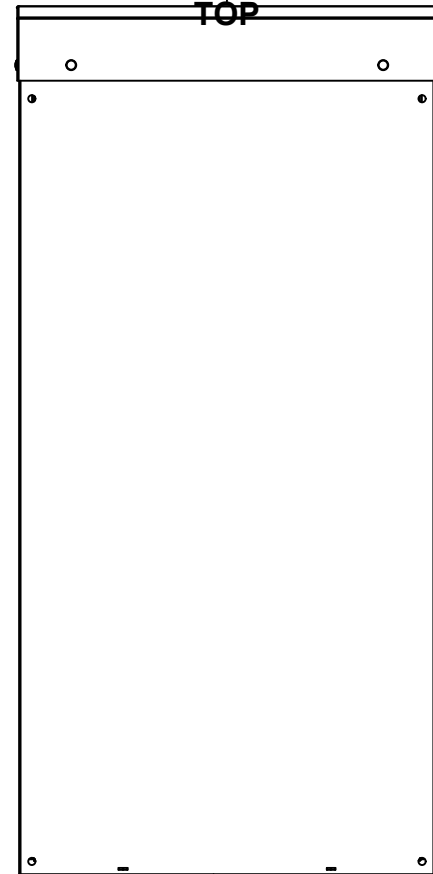

BACK



BOTTOM

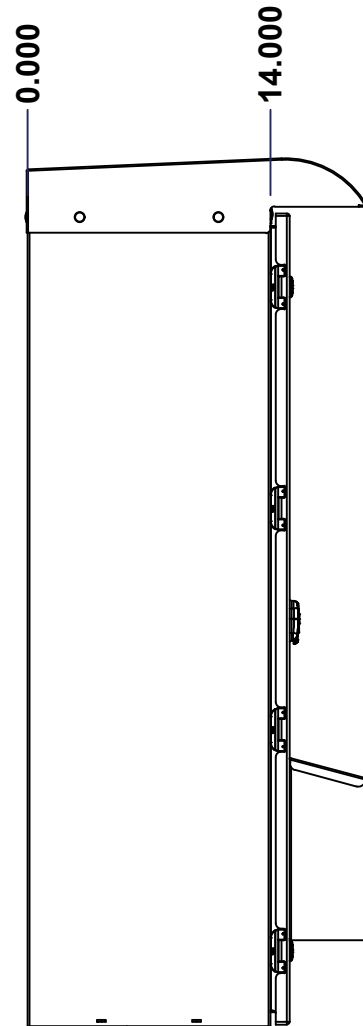

LEFT

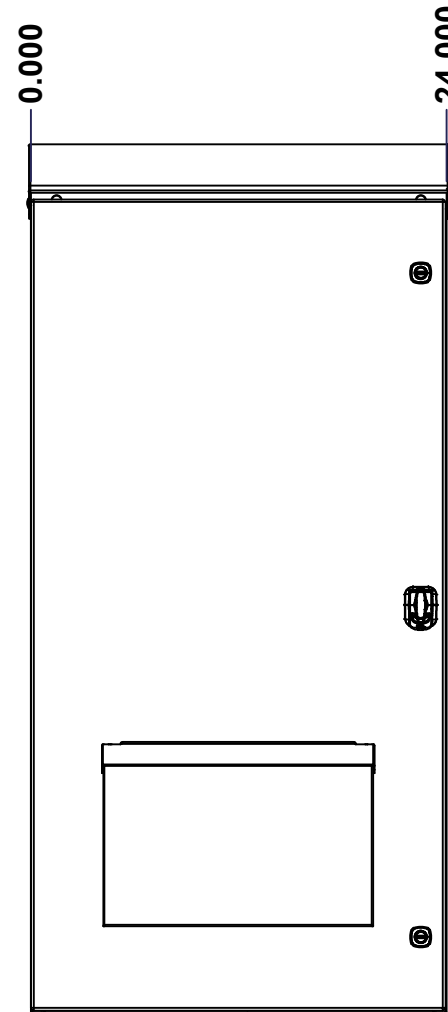

FRONT

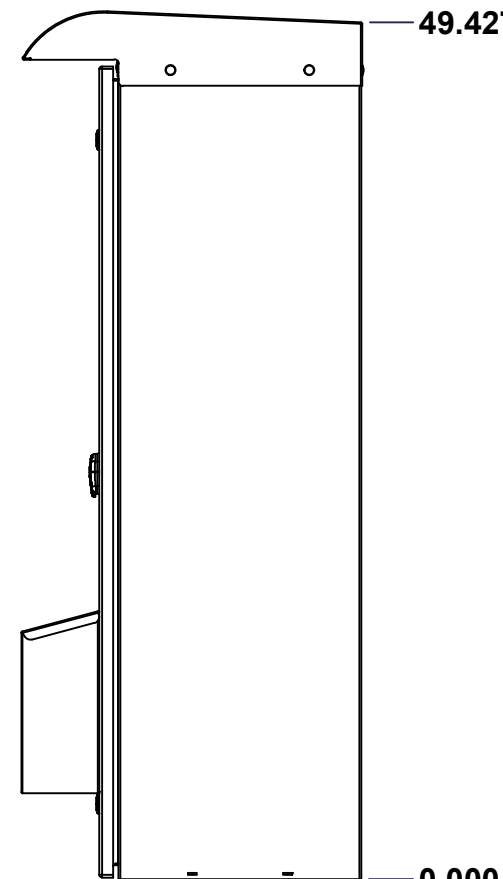

RIGHT

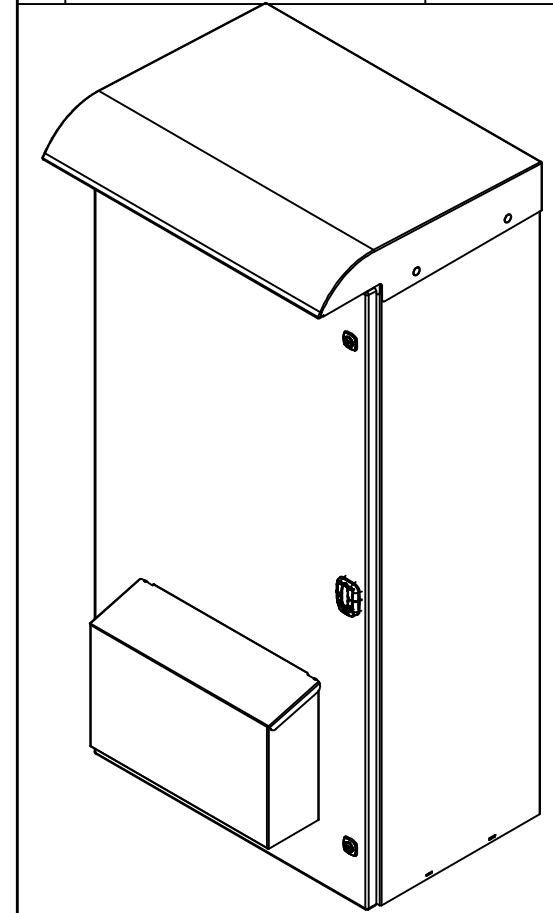

Isometric View

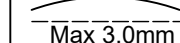
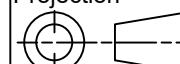

No.	Revisions	Date	By/Par

 Tél: (450) 979-4373 Fax: (450) 979-4626 www.exmweb.com		Flatness Aplatissement  Max 3.0mm Projection 
Customer Client	Date	
Drawn By Dessiné Par	BoxCad: BoxCad	Date 15-Mar-21
Material Matière	14 Ga Cold Rolled A1008 CS Type B (1.7mm)	
Color Couleur	White RAL9003 (Over Primer STK-P-04752)	Finish Fini Textured
Description 5300EWB 47" x 24" x 14" Assembly		Detail Rev.
Part Number Numéro Pièce	Rev. 0	1 9

SEE BILL OF MATERIAL ON LAST PAGE

5300EWB472414

This drawing is confidential and must not be reproduced or used without the consent of EXM

Ce dessin est confidentiel et ne doit pas être reproduit ou utilisé sans le consentement de EXM

NOTE	
ITEM	DESCRIPTION
1	NEMA 3, 3R Enclosure (IP64)
2	C/W Powdura® Epoxy Powder Coating Primer
3	C/W Standard ground studs on box and cover
4	W/O Standard door stiffener
5	W/O Inner panel
6	C/W Standard inner panel mounting studs
7	C/W 01141.9-00 Included (Installed)

No.	Revisions	Date	By/Par

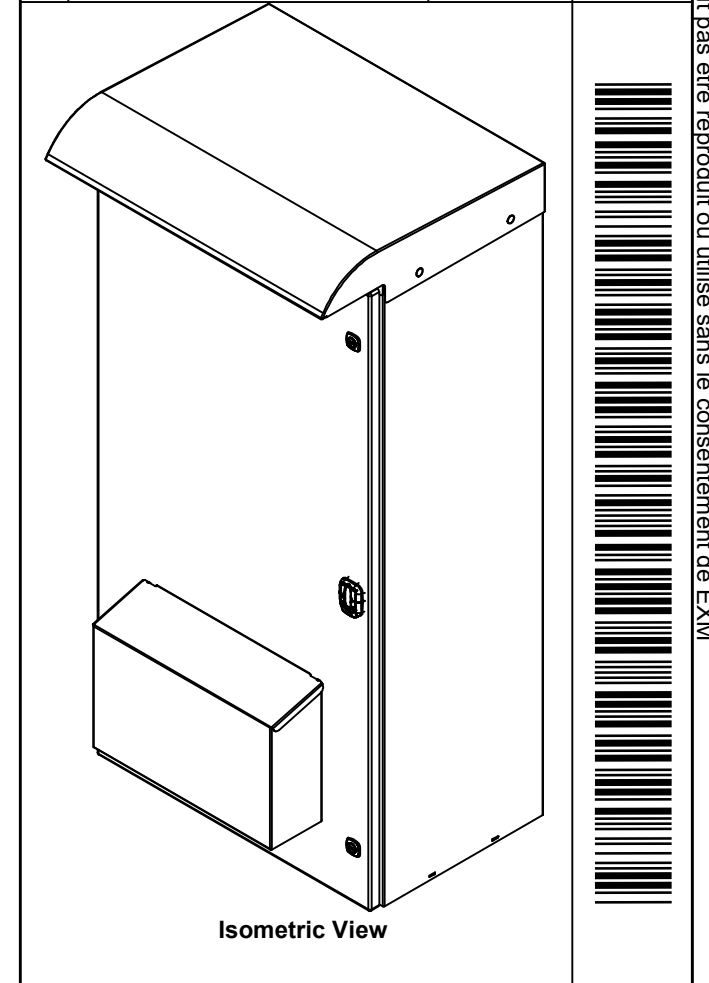

PACKING		
ITEM	QTY	DESCRIPTION
Cardboard sleeve	2	Top and Bottom
Cardboard strip	2	Between back of enclosure and inner panel
Plastic bag	1	To protect cover surface and inside gasket
Cardboard corner	4	To reinforced for the plastic strap tightening
Plastic strap - Black	2	To Squeeze 2 cardboard sleeve together
Packaging label	3	White label with PN
Plastic strap- Green	2	To secure the enclosure to the wood pallet
Wood Pallet	1	2" deeper and 3" larger than enclosure size

1	STK-K-01800	5	5412 ES Accessory Kit
4	STK-Q-04050-10	8	M6 x 10mm Hexagon Socket Head Machine Screw with Nyseal
1	5300EWB472414C	0	5300EWB 47" x 24" x 14" Cover
1	5300EWB472414B	0	5300EWB 47" x 24" x 14" Body
Qty	Part Number	Rev	Description
Parts List			

	Tél: (450) 979-4373 Fax: (450) 979-4626 www.exmweb.com	Flatness Aplatissement Max 3.0mm Projection
		Customer Client Date
Drawn By Dessiné Par BoxCad: BoxCad	Date 15-Mar-21	Material Matière 14 Ga Cold Rolled A1008 CS Type B (1.7mm)
Color Couleur White RAL9003 (Over Primer STK-P-04752)	Finish Fini Textured	Description 5300EWB 47" x 24" x 14" Assembly
Part Number Numéro Pièce 5300EWB472414	Rev. 0	Detail Rev. 2 9

This drawing is confidential and must not be reproduced or used without the consent of EXM

Ce dessin est confidentiel et ne doit pas être reproduit ou utilisé sans le consentement de EXM

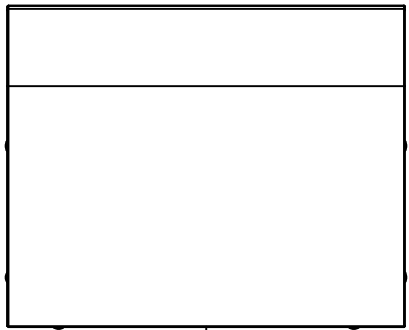

TOP

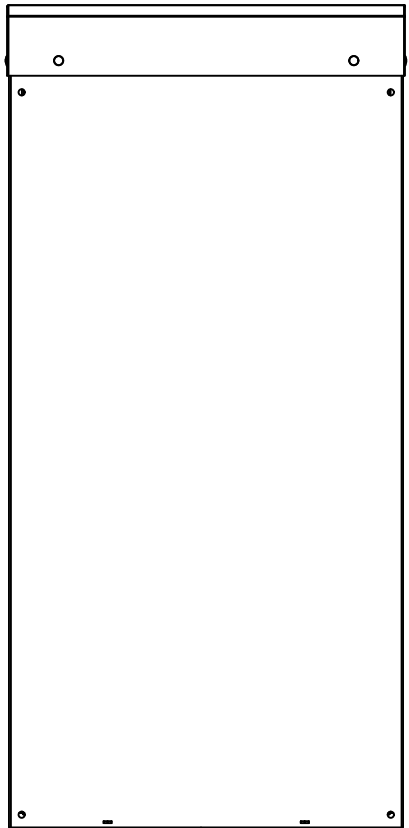

BACK

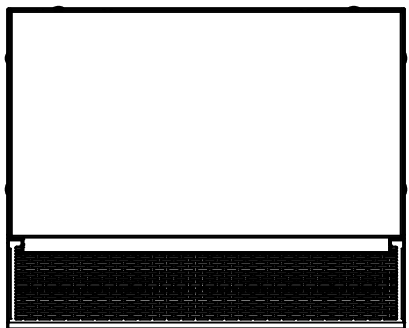

BOTTOM

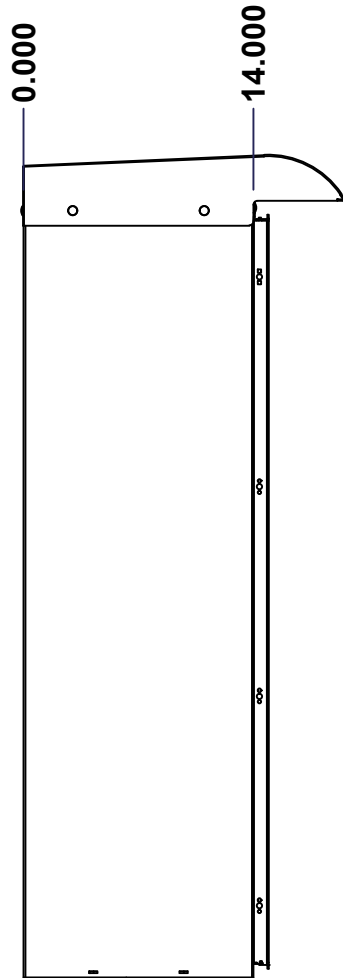

LEFT

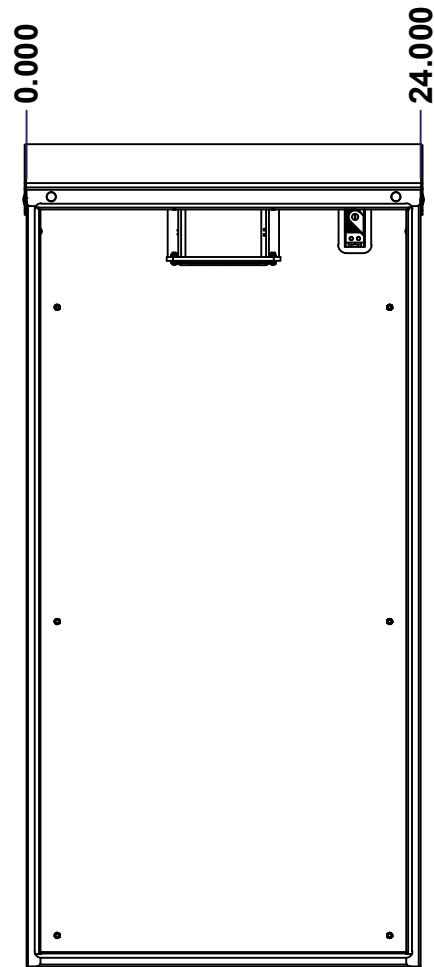

FRONT

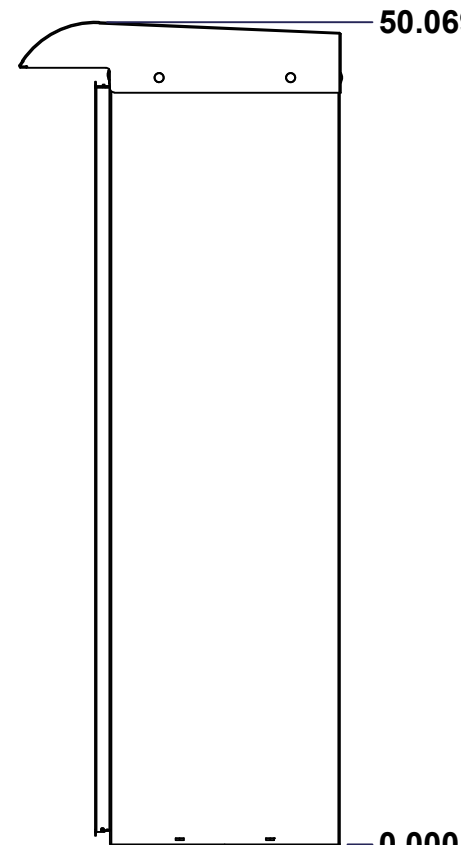

RIGHT

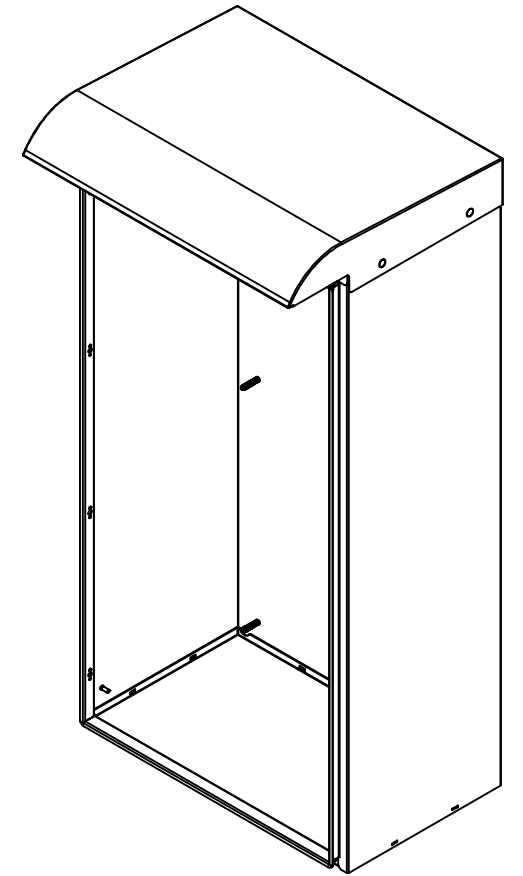

Isometric View

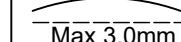
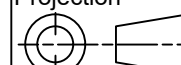

No.	Revisions	Date	By/Par

 Tél: (450) 979-4373 Fax: (450) 979-4626 www.exmweb.com		Flatness Aplatissement  Max 3.0mm Projection 
Customer Client	Date	
Drawn By Dessiné Par	BoxCad: BoxCad	Date 15-Mar-21
Material Matière	14 Ga Cold Rolled A1008 CS Type B (1.7mm)	
Color Couleur	White RAL9003 (Over Primer STK-P-04752)	Finish Fini Textured
Description	Detail Rev.	
5300EWB 47" x 24" x 14" Body		
Part Number Numéro Pièce	Rev. 0	3 9
5300EWB472414B		

SEE BILL OF MATERIAL ON LAST PAGE

This drawing is confidential and must not be reproduced or used without the consent of EXM

Ce dessin est confidentiel et ne doit pas être reproduit ou utilisé sans le consentement de EXM

STANDARD FEATURES ARE NOT LISTED IN THIS HOLE TABLE			
HOLE TABLE - LEFT VIEW (CUSTOM FEATURE ONLY)			
CUT-OUT	XDIM	YDIM	DESCRIPTION
1	12.500	2.000	GND STUD M6 x 16mm (Inside)

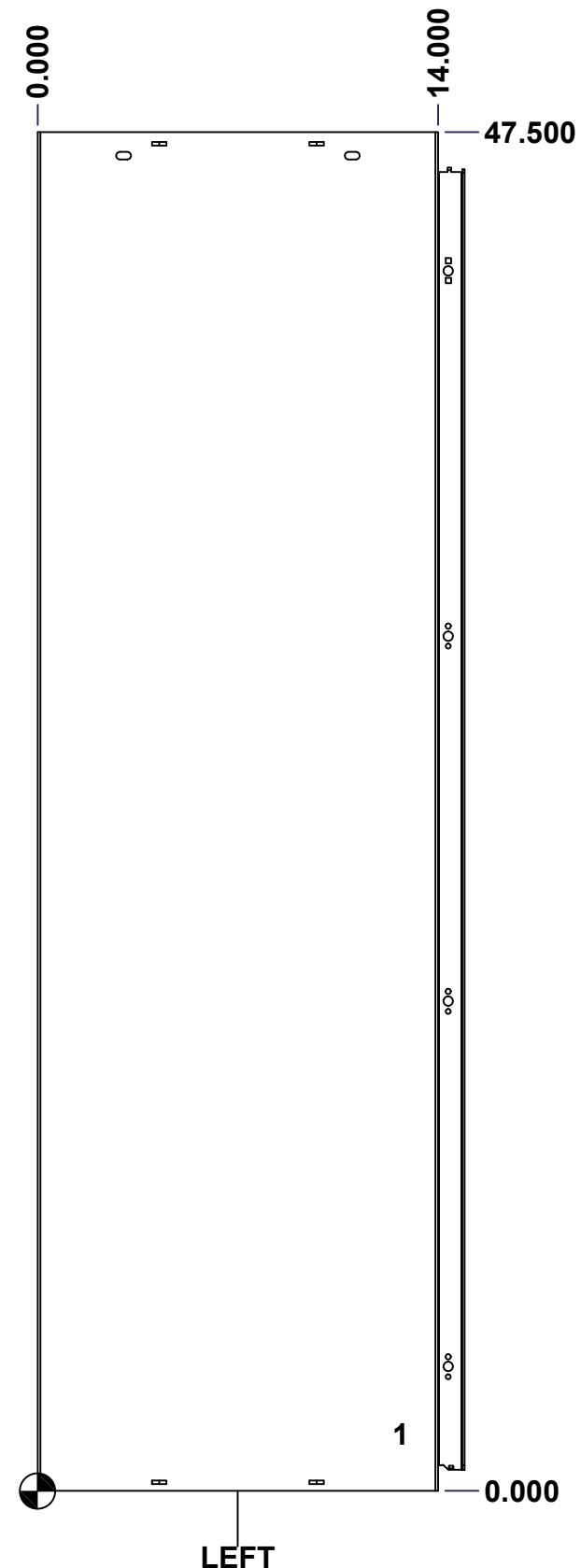

	Description	Status	
	5300EWB 47" x 24" x 14" Body	(NULL)	
	Part Number Numéro Pièce	Rev.	
	5300EWB472414B	0	4 9

This drawing is confidential and must not be reproduced or used without the consent of EXM

Ce dessin est confidentiel et ne doit pas être reproduit ou utilisé sans le consentement de EXM

STANDARD FEATURES ARE NOT LISTED IN THIS HOLE TABLE

HOLE TABLE - BACK VIEW (CUSTOM FEATURE ONLY)

CUT-OUT	XDIM	YDIM	DESCRIPTION
1	1.875	1.875	IP STUD M8 x 35mm (Inside)
2	1.875	40.125	IP STUD M8 x 35mm (Inside)
3	22.125	40.125	IP STUD M8 x 35mm (Inside)
4	22.125	1.875	IP STUD M8 x 35mm (Inside)
5	1.875	21.000	IP STUD M8 x 35mm (Inside)
6	22.125	21.000	IP STUD M8 x 35mm (Inside)

7	23.250	0.750	RND Ø0.390
8	23.250	44.750	RND Ø0.390
9	0.750	44.750	RND Ø0.390
10	0.750	0.750	RND Ø0.390

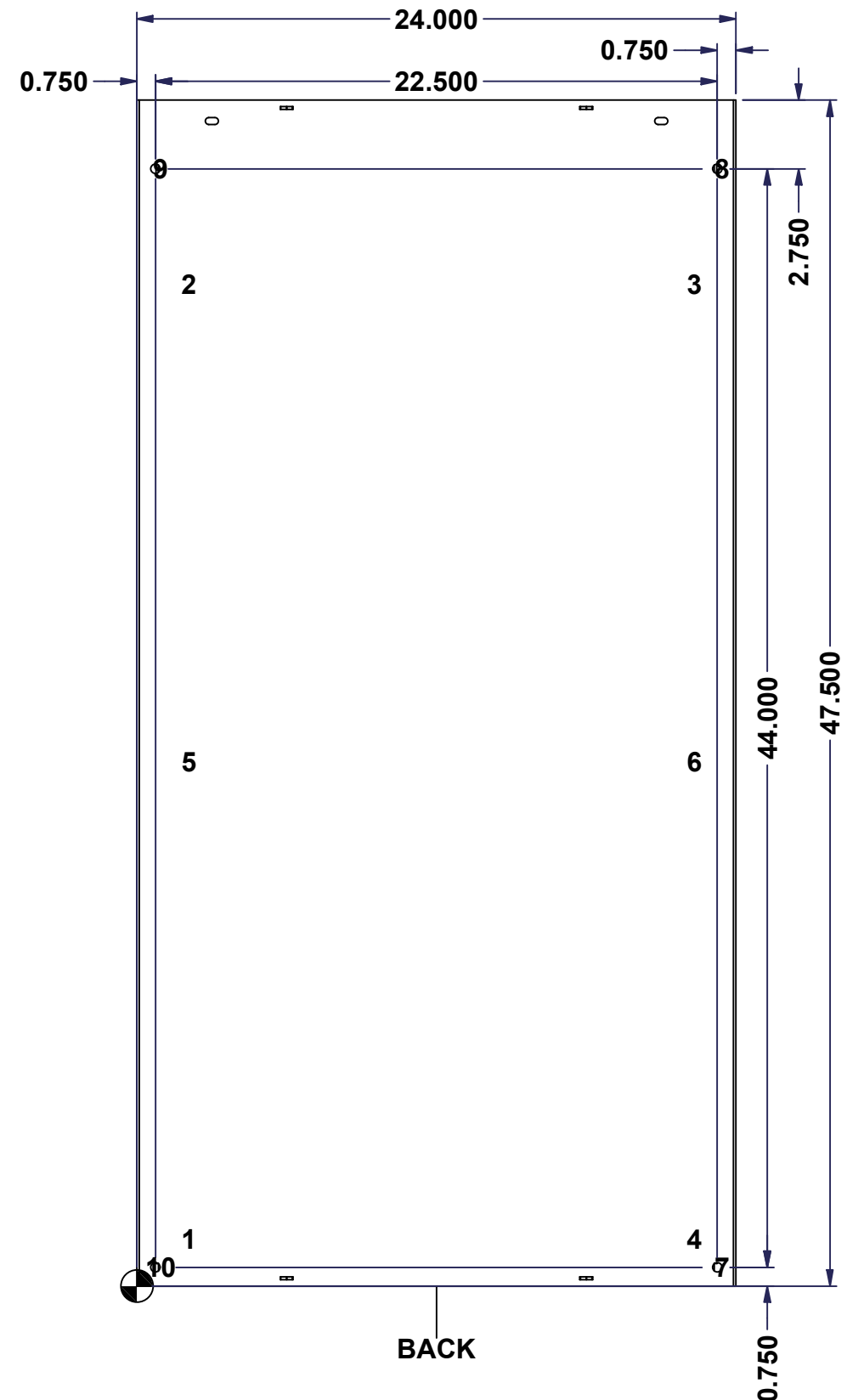

BACK

	Description	Status	
	5300EWB 47" x 24" x 14" Body	(NULL)	
	Part Number Numéro Pièce	Rev.	
	5300EWB472414B	0	5 9

This drawing is confidential and must not be reproduced or used without the consent of EXM

Ce dessin est confidentiel et ne doit pas être reproduit ou utilisé sans le consentement de EXM

No.	Revisions	Date	By/Par

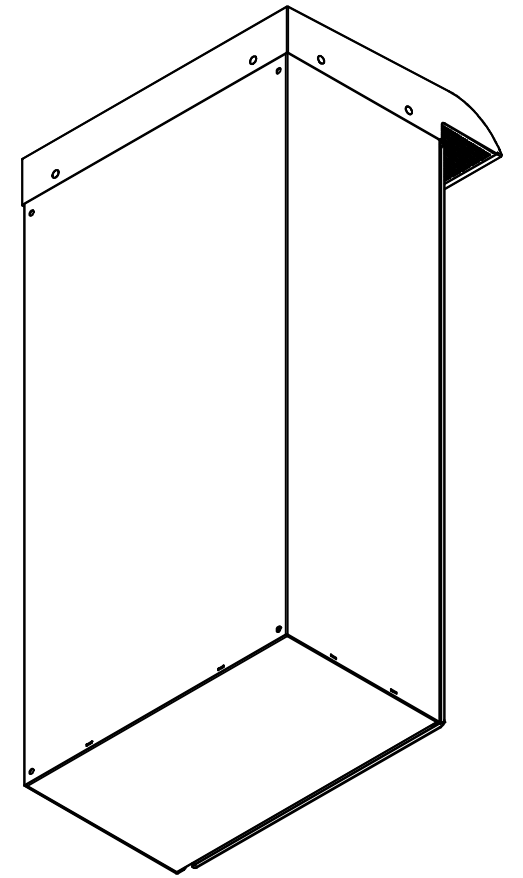

Isometric View

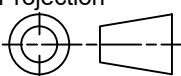

1	STK-Q-16080	0	Ground Stud M6 x 16mm Steel
1	STK-P-04752	0	Epoxy Primer Gray Powdura EAS6-C0000 (Bottom Layer)
1	STK-P-02401R	0	Powder Paint (White / Rough Textured)
1	01141.9-00	0	Small Thermostat (°F Normally Open)
1	iLogic_MASTER_5300EW B_THERMOSTAT_14GA	2	5300EWB Thermostat Support Part
1	880HFP325-335-115	1	Filter Fan 325x325mm (335CFM)
1	5300EWB472414GP-P	0	5300EWB 47" x 24" x 14" Fan Gland Plate Part
2	STK-Q-05020	5	M5 x 8mm Thread Rolling Screw
8	STK-Q-07220	1	M6 Nylon Insert Lock Nut
8	STK-Q-00260	1	M6 x 13mm Carriage Bolt
1	5300EWB472414T-P	0	5300EWB 24" x 14" Top Part
6	STK-Q-16005	1	Stud M8 x 35mm (No Paint Cap Required)
1	5300EWB472414BT-P	0	5300EWB 47" x 24" x 14" Bottom Part
1	5300EWB472414F-P	0	5300EWB 47" x 24" x 14" Front Part
1	5300EWB472414B-P	0	5300EWB 47" x 24" x 14" Body Part
Qty	Part Number	Rev	Description
Parts List			

 Tél: (450) 979-4373 Fax: (450) 979-4626 www.exmweb.com	Flatness Aplatissement	Max 3.0mm
	Projection	
Customer Client	Date	
Drawn By Dessiné Par	BoxCad: BoxCad	Date 15-Mar-21
Material Matière	14 Ga Cold Rolled A1008 CS Type B (1.7mm)	
Color Couleur	White RAL9003 (Over Primer STK-P-04752)	Finish Fini Textured
Description	5300EWB 47" x 24" x 14" Body	
Part Number Numéro Pièce	Rev.	6
5300EWB472414B	0	9

This drawing is confidential and must not be reproduced or used without the consent of EXM

Ce dessin est confidentiel et ne doit pas être reproduit ou utilisé sans le consentement de EXM

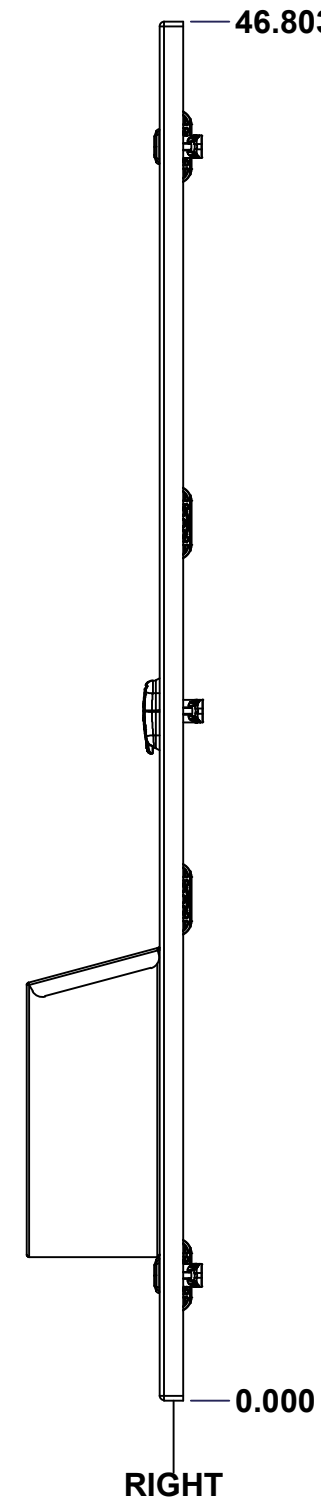
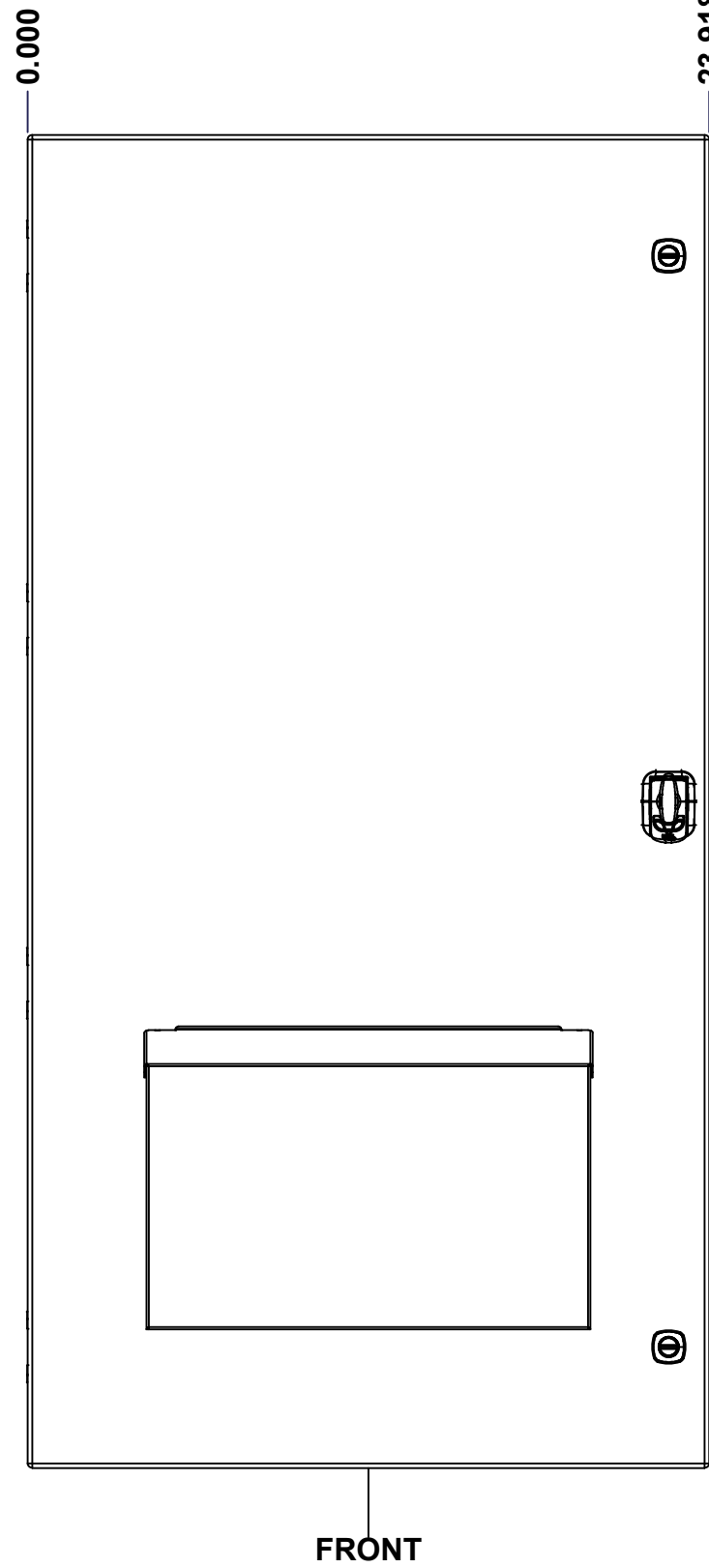
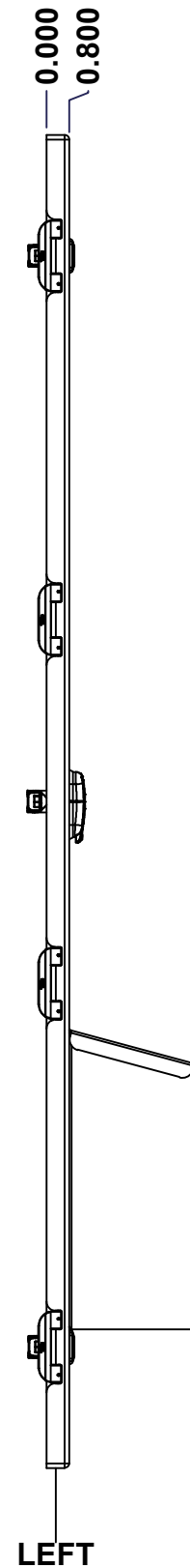
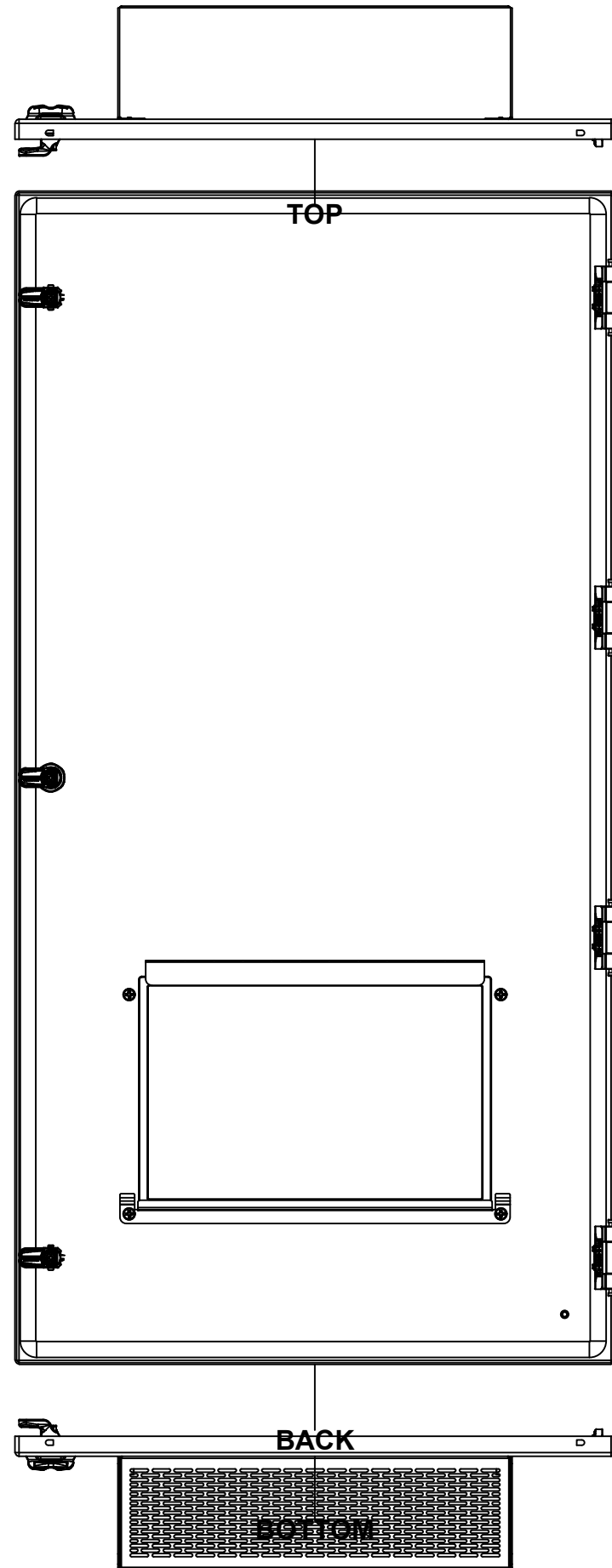

No.	Revisions	Date	By/Par

Isometric View

		Flatness Aplatissement Max 3.0mm Projection 	
Customer Client		Date	
Drawn By Dessiné Par BoxCad: BoxCad		Date 15-Mar-21	
Material Matière 14 Ga Cold Rolled A1008 CS Type B (1.7mm)			
Color Couleur White RAL9003 (Over Primer STK-P-04752)		Finish Fini Textured	
Description 5300EWB 47" x 24" x 14" Cover			Detail Rev.
Part Number Numéro Pièce 5300EWB472414C		Rev. 0	7 9

SEE BILL OF MATERIAL ON LAST PAGE

This drawing is confidential and must not be reproduced or used without the consent of EXM

Ce dessin est confidentiel et ne doit pas être reproduit ou utilisé sans le consentement de EXM

STANDARD FEATURES ARE NOT LISTED IN THIS HOLE TABLE

HOLE TABLE - FRONT VIEW (CUSTOM FEATURE ONLY)

CUT-OUT	XDIM	YDIM	DESCRIPTION
1	2.000	2.000	GND STUD M6 x 16mm (Inside)
2	22.494	42.553	LOCK 880 SCQ4-SL @ 0.0°
3	22.494	23.402	LOCK 880 SCQ4PL-SL @ 0.0°
4	22.494	4.250	LOCK 880 SCQ4-SL @ 0.0°

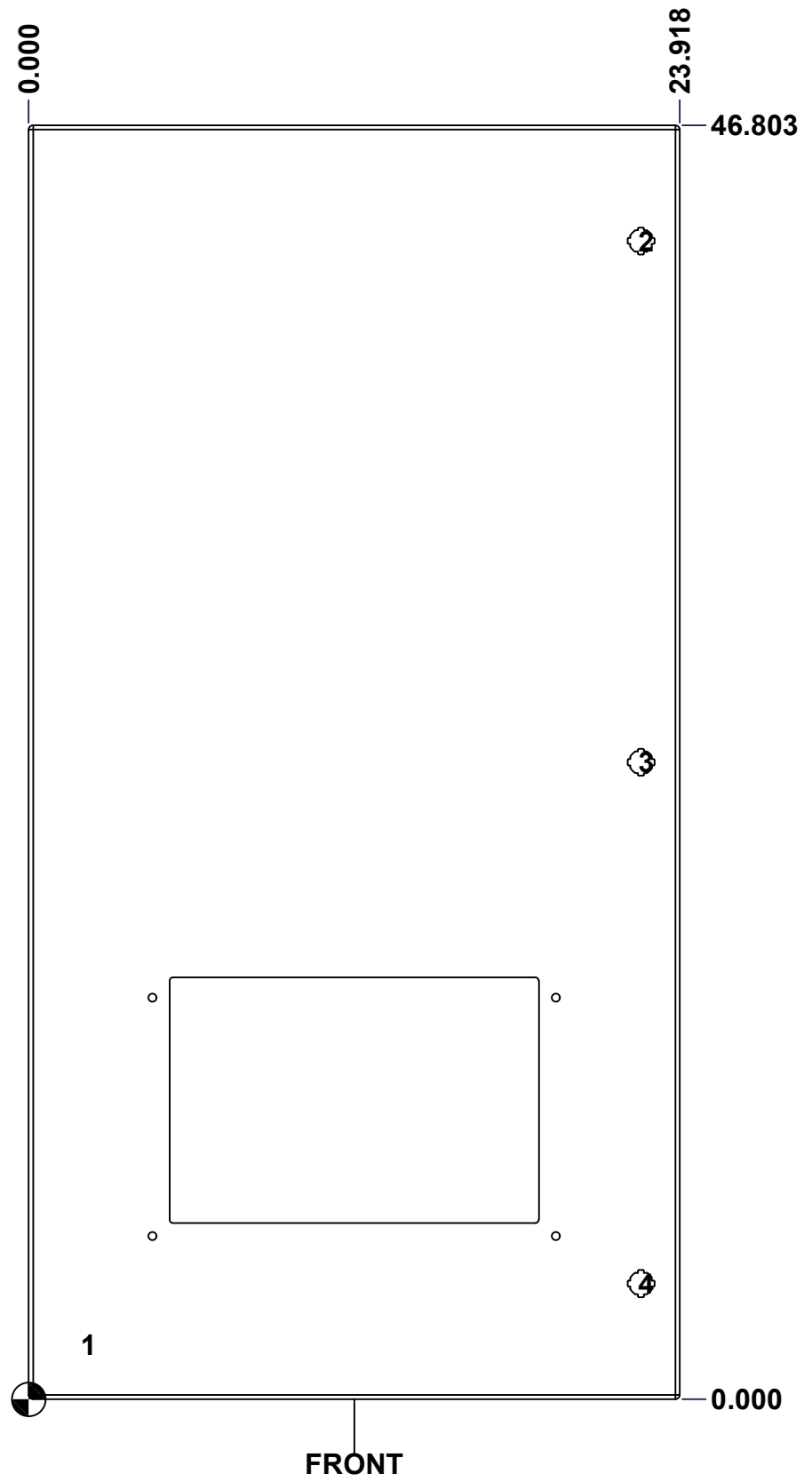

	Description	Status
	5300EWB 47" x 24" Cover	(NULL)
Part Number Numéro Pièce 5300EWB472414C	Rev.	8
	0	9

This drawing is confidential and must not be reproduced or used without the consent of EXM

Ce dessin est confidentiel et ne doit pas être reproduit ou utilisé sans le consentement de EXM

No.	Revisions	Date	By/Par

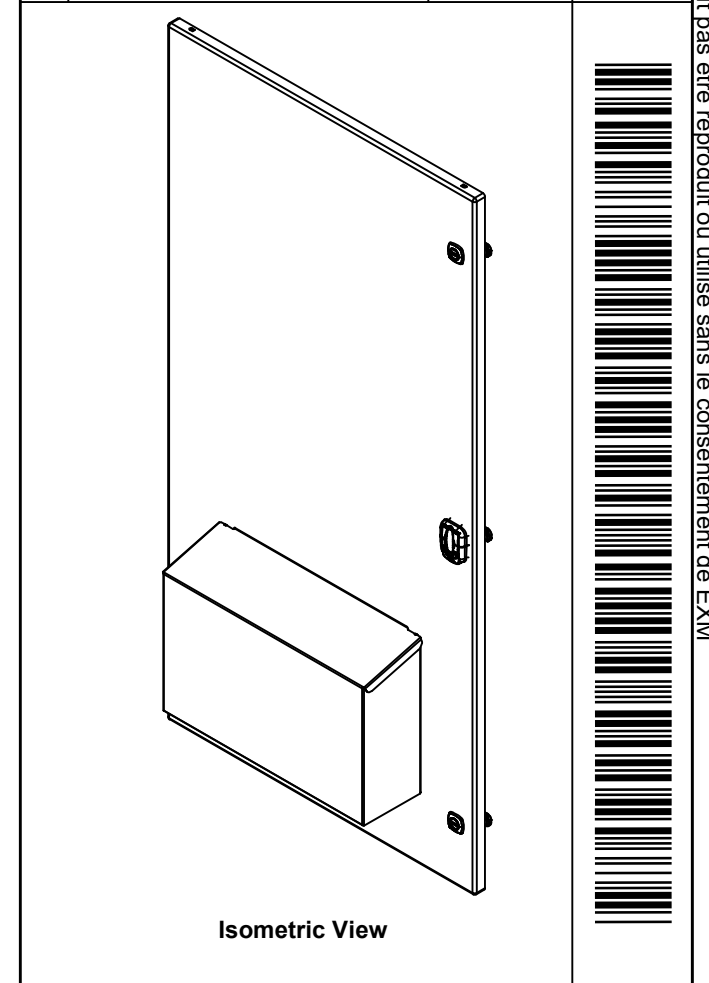



Tél: (450) 979-4373
Fax: (450) 979-4626
www.exmweb.com

Flatness
Aplatissement
Max 3.0mm

Projection



1	880 SCQ4PL-SL	3	5412 ES Padlockable 1/4 Turn Lock
2	STK-K-12500	19	5412 ES 1/4 Turn Lock
1	STK-Q-16080	0	Ground Stud M6 x 16mm Steel
1	STK-P-04752	0	Epoxy Primer Gray Powdura EAS6-C0000 (Bottom Layer)
1	STK-P-02401R	0	Powder Paint (White / Rough Textured)
1	5300EWB472414LPF	0	Filter 14.062" x 9.250"
1	5300EWB472414FPH335	0	5300EWB 47" x 24" x 14" Rain Hood
1	5300EWB472414G	0	5300EWB 47" x 24" Cover Gasket Part
4	STK-K-09800	10	5412 ES Hinge with 2 Captive Hinge Pins
1	5300EWB472414C-P	0	5300EWB 47" x 24" Cover Part

Customer Client	Date
Drawn By Dessiné Par BoxCad: BoxCad	Date 15-Mar-21
Material Matière 14 Ga Cold Rolled A1008 CS Type B (1.7mm)	
Color Couleur White RAL9003 (Over Primer STK-P-04752)	Finish Fini Textured
Description 5300EWB 47" x 24" x 14" Cover	Detail Rev.
Part Number Numéro Pièce 5300EWB472414C	Rev. 9 0

Qty	Part Name	Rev	Description
Parts List			