

This drawing is confidential and must not be reproduced or used without the consent of EXM

Ce dessin est confidentiel et ne doit pas être reproduit ou utilisé sans le consentement de EXM

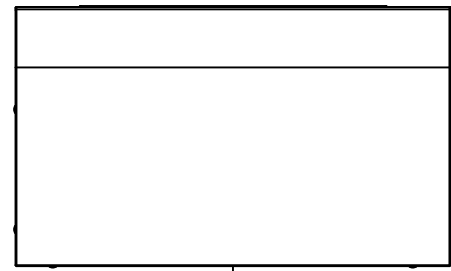

TOP

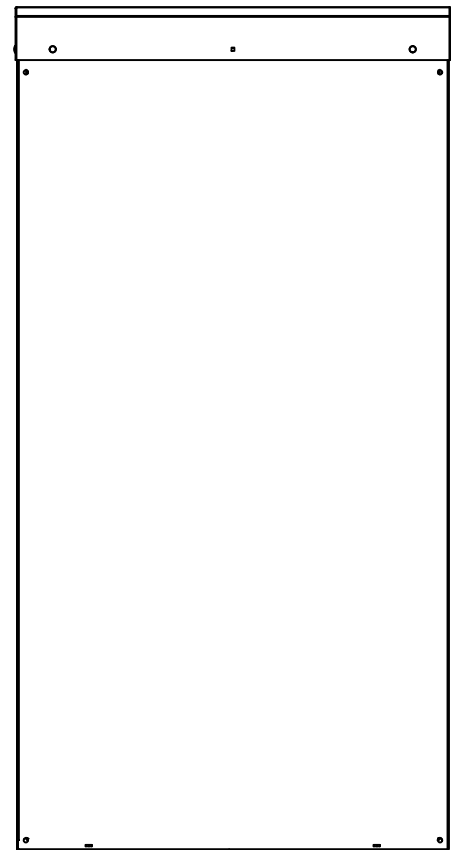

BACK



BOTTOM

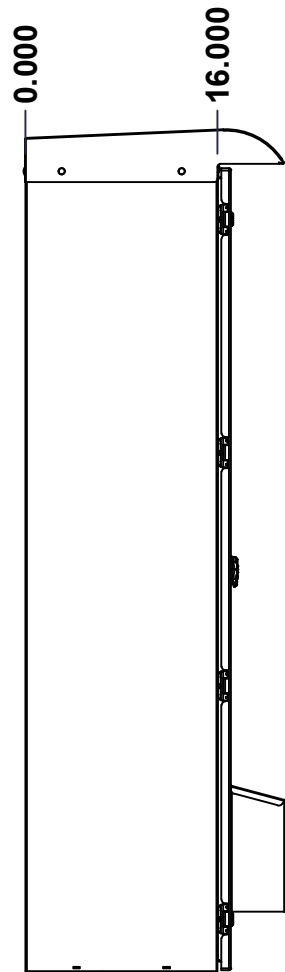

LEFT

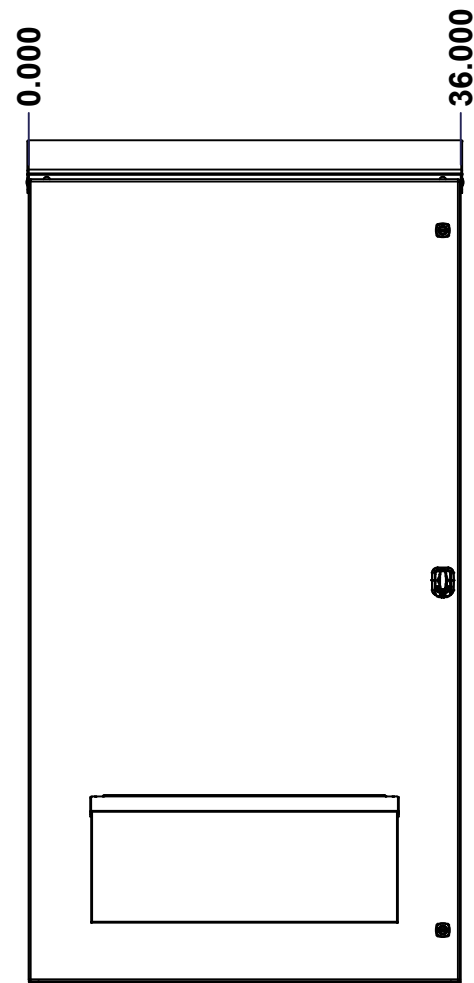

FRONT

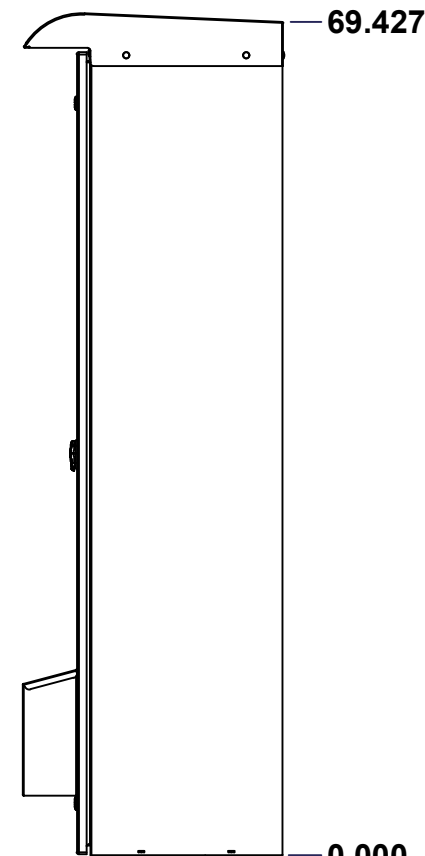

RIGHT

No.	Revisions	Date	By/Par

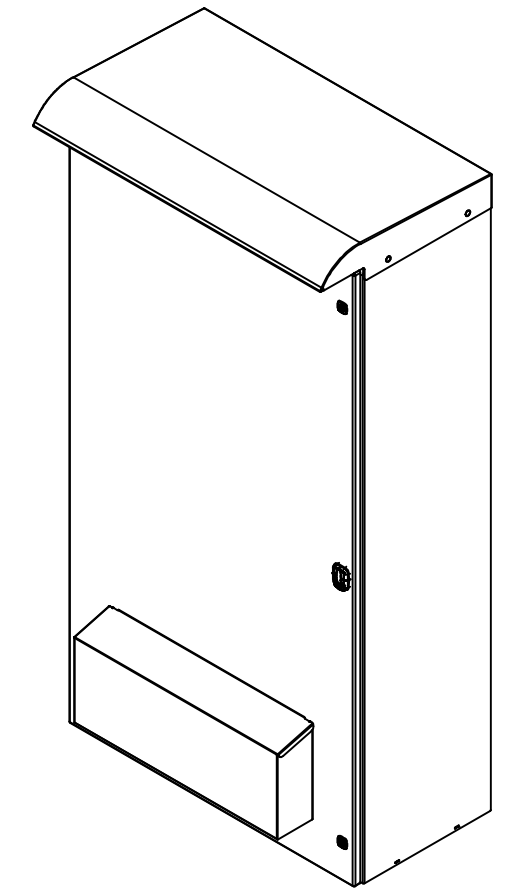

Isometric View



Tél: (450) 979-4373
 Fax: (450) 979-4626
www.exmweb.com

Flatness
 Aplatissement
 Max 3.0mm
 Projection

Customer Client	Date
Drawn By / Dessiné Par: BoxCad: BoxCad	Date: 15-Mar-21
Material / Matière: 14 Ga Cold Rolled A1008 CS Type B (1.7mm)	

Color / Couleur: White RAL9003 (Over Primer STK-P-04752)	Finish / Fini: Rough Textured
--	-------------------------------

Description: 5300EWB 67" x 36" x 16" Assembly	Detail Rev.
---	-------------

Part Number / Numéro Pièce: 5300EWB673616	Rev. 0	1	9
---	--------	---	---

SEE BILL OF MATERIAL ON LAST PAGE

This drawing is confidential and must not be reproduced or used without the consent of EXM

Ce dessin est confidentiel et ne doit pas être reproduit ou utilisé sans le consentement de EXM

NOTE	
ITEM	DESCRIPTION
1	NEMA 3, 3R Enclosure (IP64)
2	C/W Powdura® Epoxy Powder Coating Primer
3	C/W Standard ground studs on box and cover
4	W/O Standard door stiffener
5	W/O Inner panel
6	C/W Standard inner panel mounting studs
7	C/W 01141.9-00 Included (Installed)

No.	Revisions	Date	By/Par

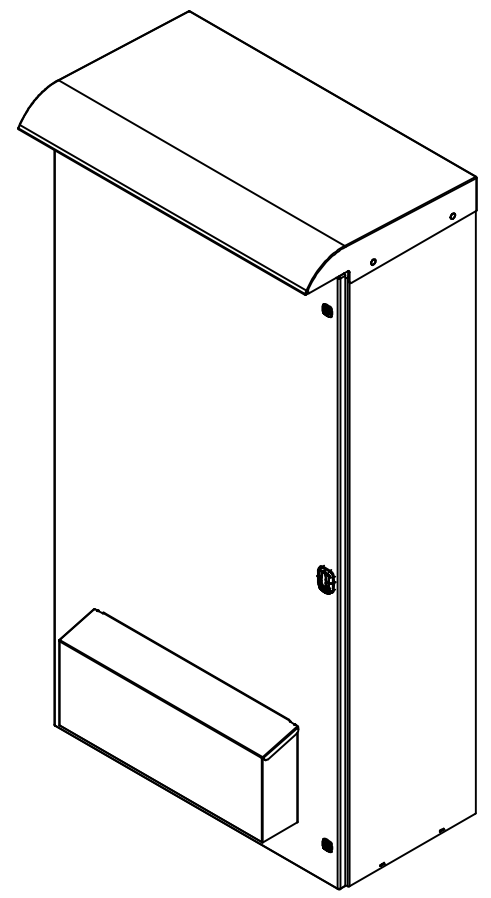

Isometric View



PACKING		
ITEM	QTY	DESCRIPTION
Cardboard sleeve	2	Top and Bottom
Cardboard strip	2	Between back of enclosure and inner panel
Plastic bag	1	To protect cover surface and inside gasket
Cardboard corner	4	To reinforced for the plastic strap tightening
Plastic strap - Black	2	To Squeeze 2 cardboard sleeve together
Packaging label	3	White label with PN
Plastic strap- Green	2	To secure the enclosure to the wood pallet
Wood Pallet	1	2" deeper and 3" larger than enclosure size

Qty	Part Number	Rev	Description
4	STK-Q-04050-10	8	M6 x 10mm Hexagon Socket Head Machine Screw with Nyseal
1	5300EWB673616C	0	5300EWB 67" x 36" x 16" Cover
1	5300EWB673616B	0	5300EWB 67" x 36" x 16" Body
Parts List			

	Tél: (450) 979-4373 Fax: (450) 979-4626 www.exmweb.com	Flatness Aplatissement Max 3.0mm
	Projection 	Customer Client Date
Drawn By Dessiné Par BoxCad: BoxCad	Date 15-Mar-21	Material Matière 14 Ga Cold Rolled A1008 CS Type B (1.7mm)
Color Couleur White RAL9003 (Over Primer STK-P-04752)	Finish Fini Rough Textured	Description 5300EWB 67" x 36" x 16" Assembly
Part Number Numéro Pièce 5300EWB673616	Rev. 0	Detail Rev. 2 9

This drawing is confidential and must not be reproduced or used without the consent of EXM

Ce dessin est confidentiel et ne doit pas être reproduit ou utilisé sans le consentement de EXM

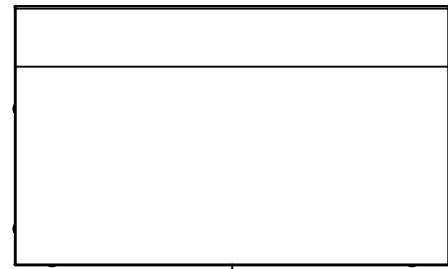

TOP

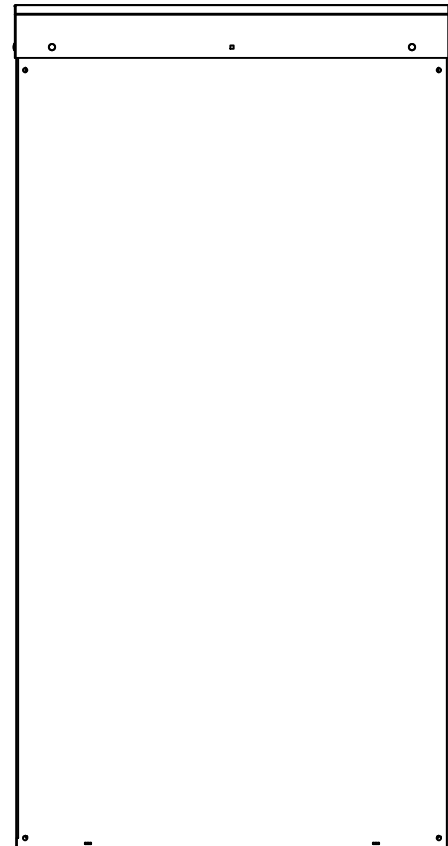

BACK



BOTTOM

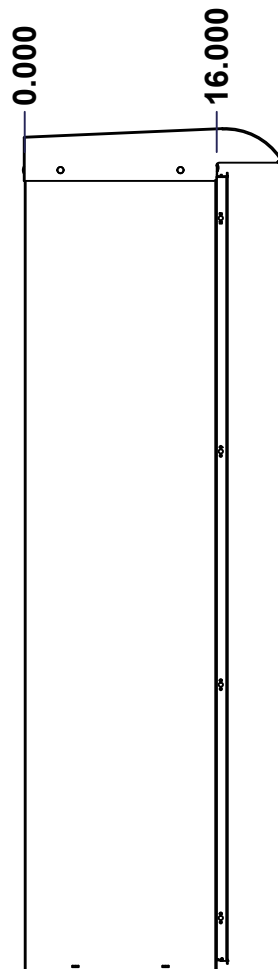

LEFT

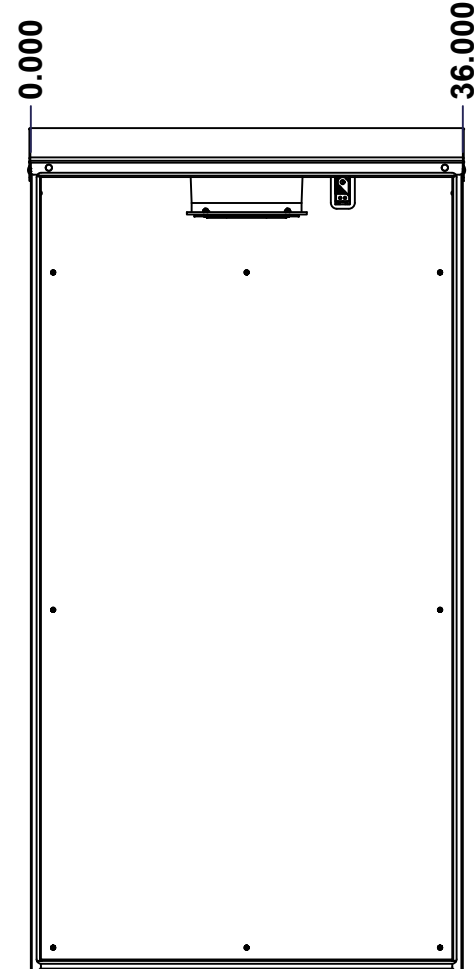

FRONT

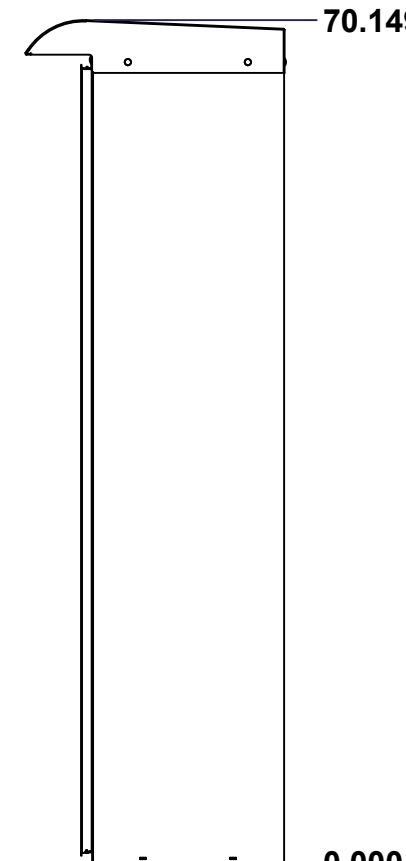

RIGHT

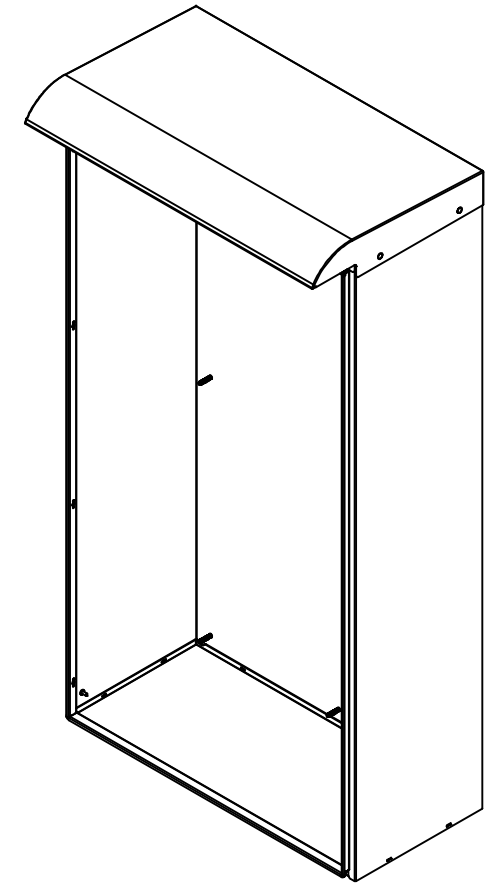

Isometric View

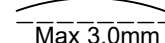
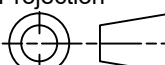

No.	Revisions	Date	By/Par

 Tél: (450) 979-4373 Fax: (450) 979-4626 www.exmweb.com		Flatness Aplatissement  Max 3.0mm Projection 
Customer Client	Date	
Drawn By Dessiné Par	BoxCad: BoxCad	Date 15-Mar-21
Material Matière	14 Ga Cold Rolled A1008 CS Type B (1.7mm)	
Color Couleur	White RAL9003 (Over Primer STK-P-04752)	Finish Fini Rough Textured
Description	Detail Rev.	
5300EWB 67" x 36" x 16" Body		
Part Number Numéro Pièce	Rev.	3
5300EWB673616B	0	9

SEE BILL OF MATERIAL ON LAST PAGE

This drawing is confidential and must not be reproduced or used without the consent of EXM

Ce dessin est confidentiel et ne doit pas être reproduit ou utilisé sans le consentement de EXM

STANDARD FEATURES ARE NOT LISTED IN THIS HOLE TABLE			
HOLE TABLE - LEFT VIEW (CUSTOM FEATURE ONLY)			
CUT-OUT	XDIM	YDIM	DESCRIPTION
1	14.500	2.000	GND STUD M6 x 16mm (Inside)

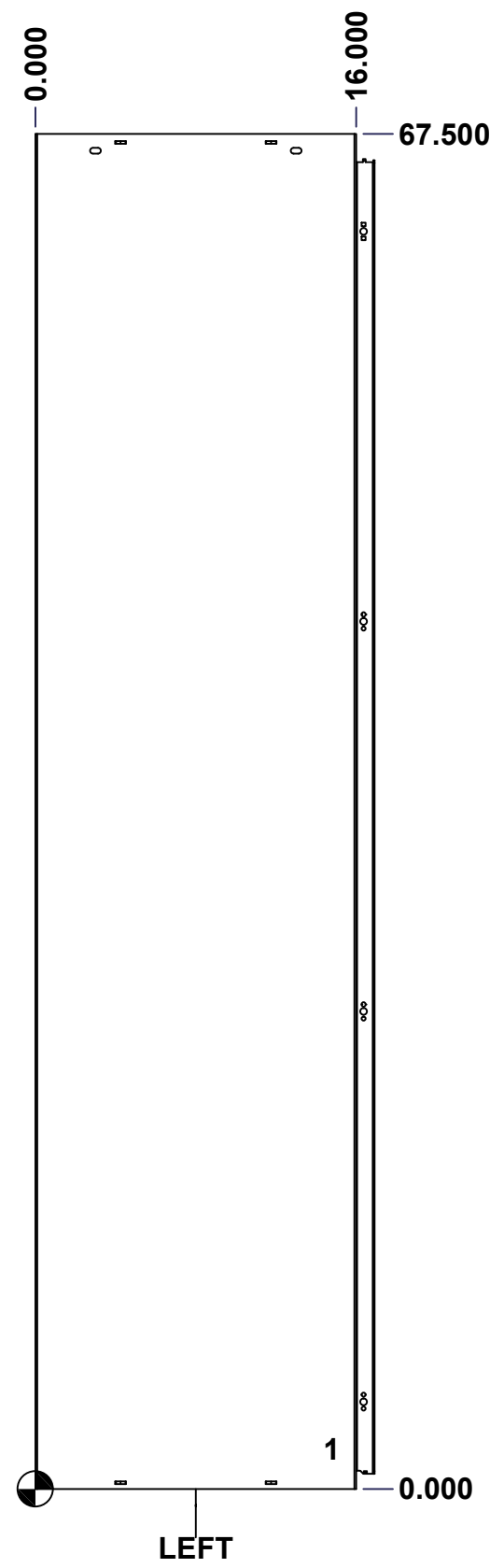

	Description	Status	
	5300EWB 67" x 36" x 16" Body	(NULL)	
	Part Number Numéro Pièce	Rev.	
	5300EWB673616B	0	4 9

This drawing is confidential and must not be reproduced or used without the consent of EXM

Ce dessin est confidentiel et ne doit pas être reproduit ou utilisé sans le consentement de EXM

STANDARD FEATURES ARE NOT LISTED IN THIS HOLE TABLE

HOLE TABLE - BACK VIEW (CUSTOM FEATURE ONLY)

CUT-OUT	XDIM	YDIM	DESCRIPTION
1	1.807	1.875	IP STUD M8 x 35mm (Inside)
2	1.807	58.125	IP STUD M8 x 35mm (Inside)
3	34.057	58.125	IP STUD M8 x 35mm (Inside)
4	34.057	1.875	IP STUD M8 x 35mm (Inside)
5	1.807	30.000	IP STUD M8 x 35mm (Inside)
6	34.057	30.000	IP STUD M8 x 35mm (Inside)
7	17.932	1.875	IP STUD M8 x 35mm (Inside)
8	17.932	58.125	IP STUD M8 x 35mm (Inside)

9	35.182	0.750	RND Ø0.390
10	35.182	64.750	RND Ø0.390
11	0.682	64.750	RND Ø0.390
12	0.682	0.750	RND Ø0.390

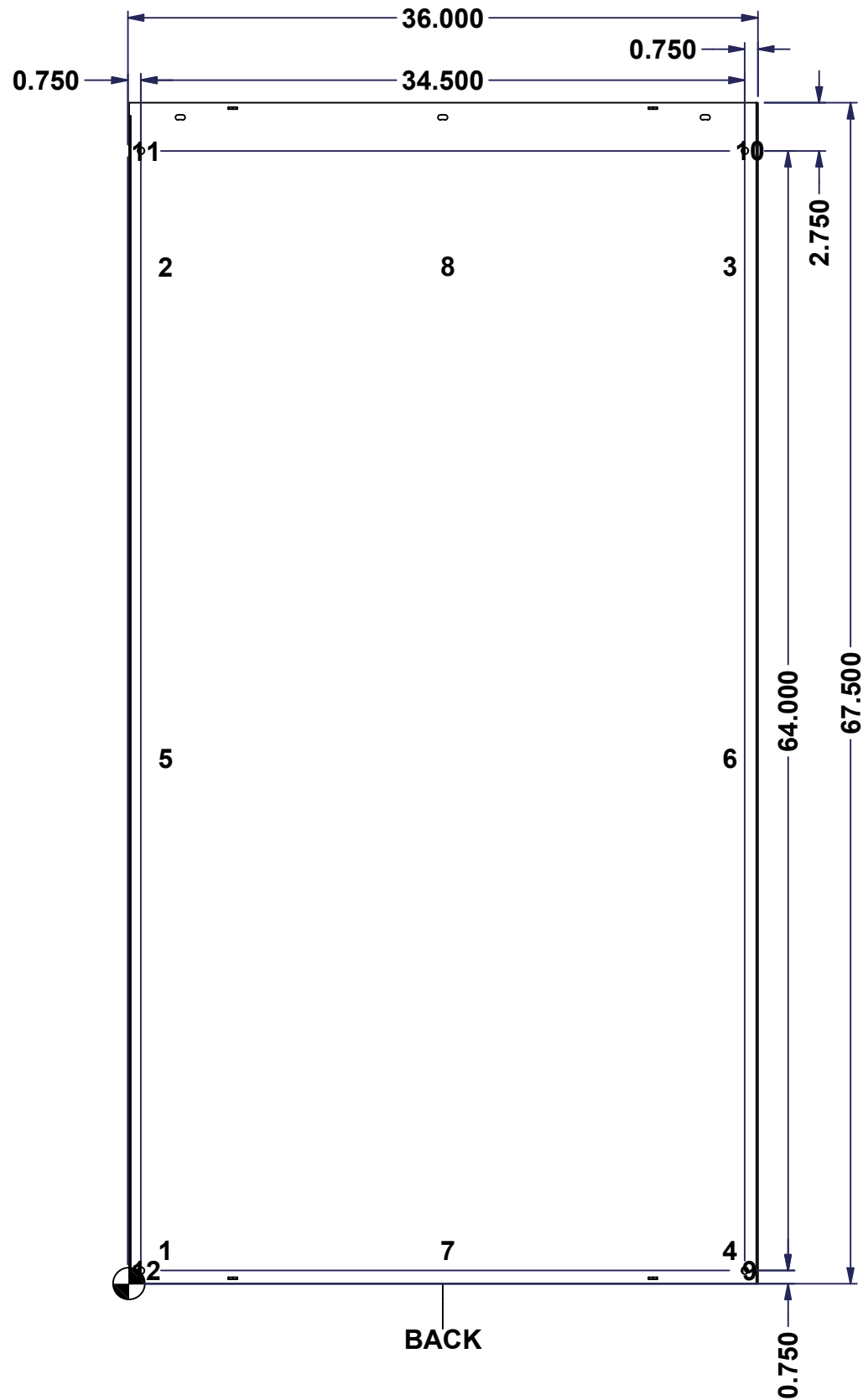

BACK

	Description	Status
	5300EWB 67" x 36" x 16" Body	(NULL)
	Part Number Numéro Pièce	Rev.
	5300EWB673616B	0 / 5 / 9

This drawing is confidential and must not be reproduced or used without the consent of EXM

Ce dessin est confidentiel et ne doit pas être reproduit ou utilisé sans le consentement de EXM

No.	Revisions	Date	By/Par

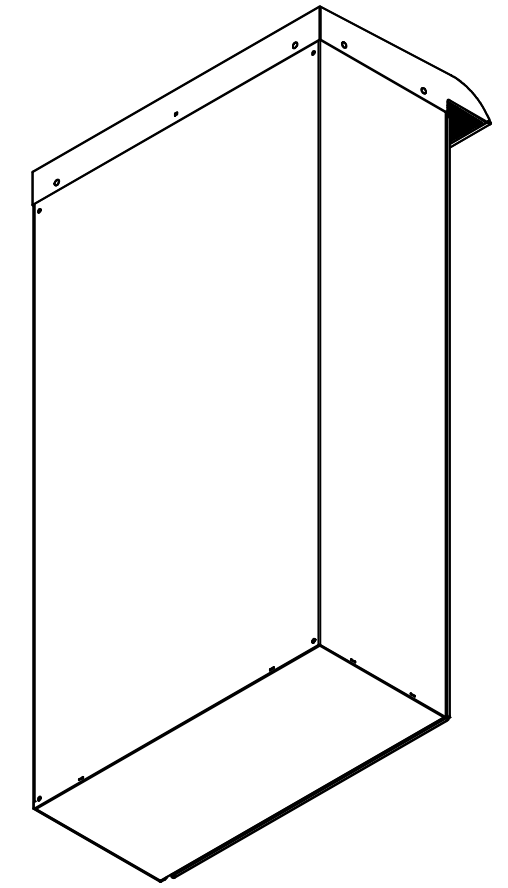

Isometric View

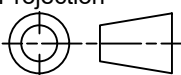

1	01141.9-00	0	Small Thermostat (°F Normally Open)
1	5300EWB673616TH-P	0	5300EWB Thermostat Support Part
1	880FP325-585-115	5	Filter Fan - 325mm x 325mm (585CFM)
8	STK-Q-16005	0	Stud M8 x 35mm Steel
1	STK-Q-16080	0	Ground Stud M6 x 16mm Steel
2	STK-Q-05020	5	M5 x 8mm Thread Rolling Screw
1	5300EWB673616GP-P	0	5300EWB 67" x 36" x 16" Fan Gland Plate Part
8	STK-Q-07220	1	M6 Nylon Insert Lock Nut
8	STK-Q-00260	1	M6 x 13mm Carriage Bolt
1	STK-P-04752	0	Epoxy Primer Gray Powdura EAS6-C0000 (Bottom Layer)
1	STK-P-02401R	0	Powder Paint (White / Rough Textured)
1	5300EWB673616RS-P	0	5300EWB 67" x 36" x 16" Right Side Part
1	5300EWB673616T-P	0	5300EWB 36" x 16" Top Part
1	5300EWB673616BT-P	0	5300EWB 67" x 36" x 16" Bottom Part
1	5300EWB673616F-P	0	5300EWB 67" x 36" x 16" Front Part
1	5300EWB673616B-P	0	5300EWB 67" x 36" x 16" Body Part
Qty	Part Number	Rev	Description
Parts List			

 Tél: (450) 979-4373 Fax: (450) 979-4626 www.exmweb.com	Flatness Aplatissement
	Max 3.0mm
Projection	
Customer Client	Date
Drawn By Dessiné Par BoxCad: BoxCad	Date 15-Mar-21
Material Matière 14 Ga Cold Rolled A1008 CS Type B (1.7mm)	
Color Couleur White RAL9003 (Over Primer STK-P-04752)	Finish Fini Rough Textured
Description 5300EWB 67" x 36" x 16" Body	Detail Rev.
Part Number Numéro Pièce 5300EWB673616B	Rev. 6 0

This drawing is confidential and must not be reproduced or used without the consent of EXM

Ce dessin est confidentiel et ne doit pas être reproduit ou utilisé sans le consentement de EXM

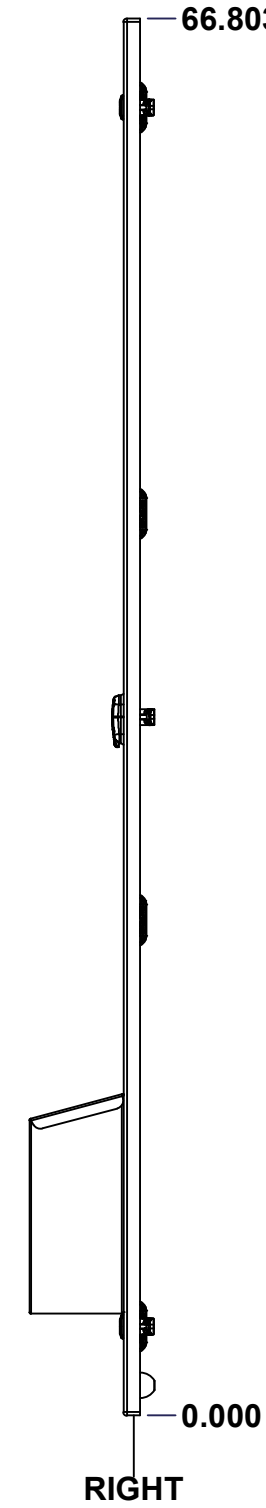
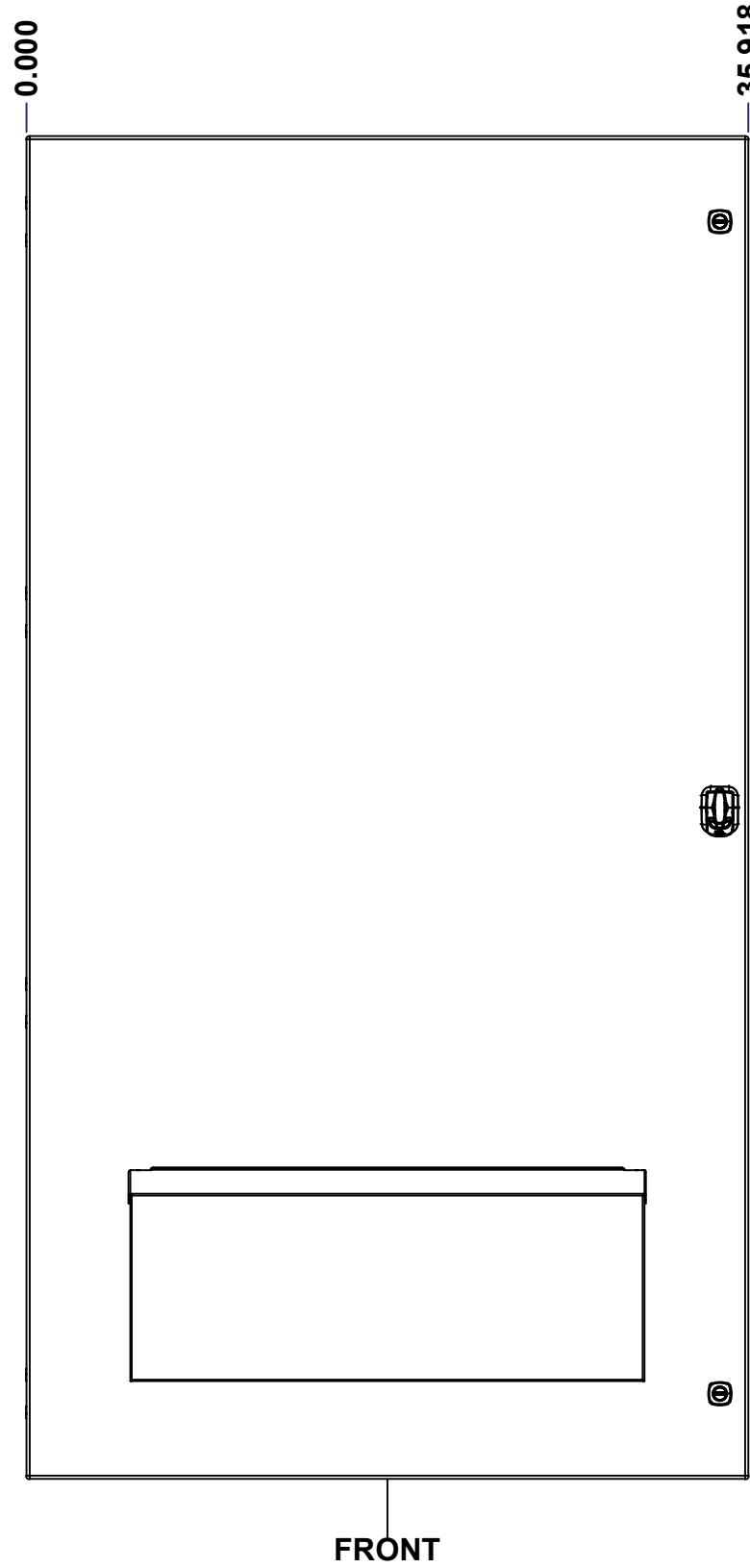
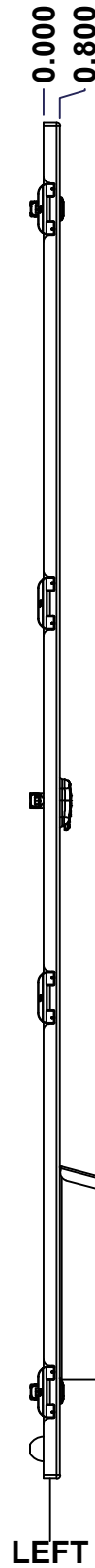
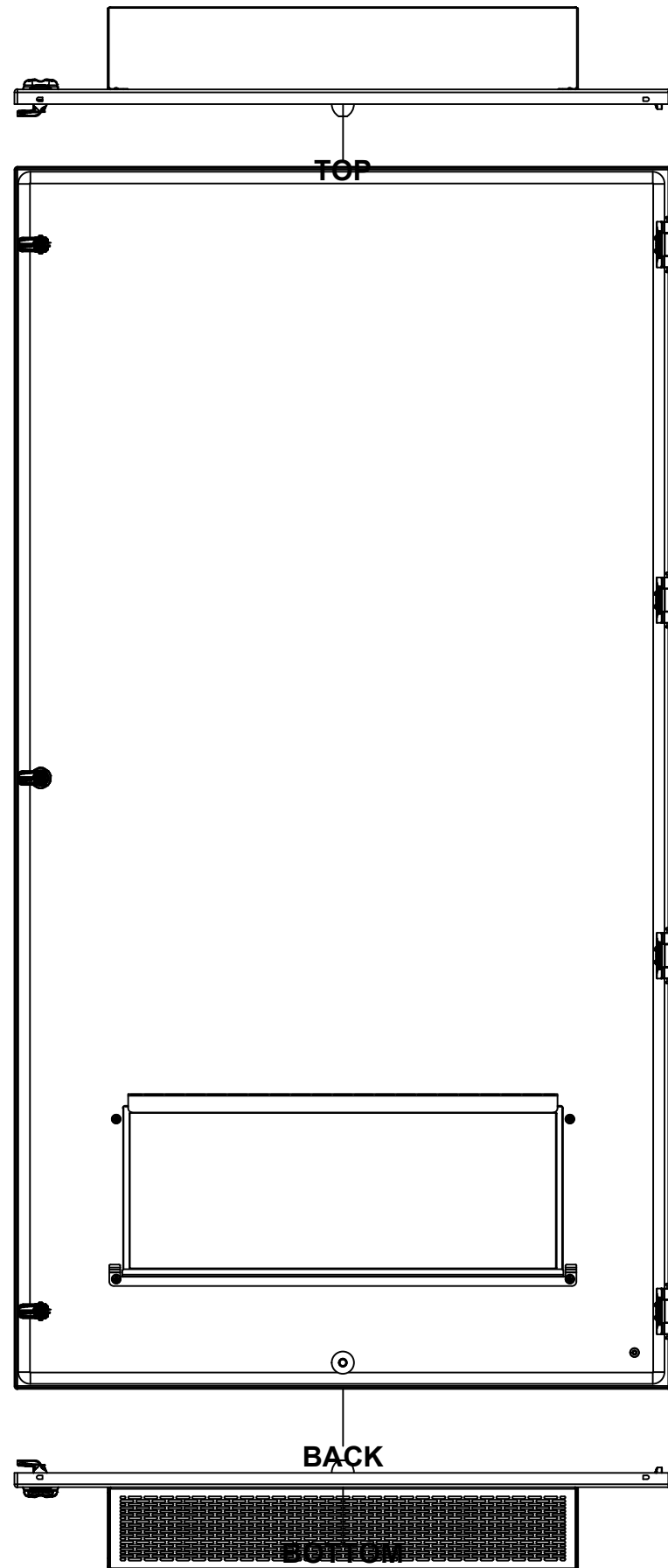

No.	Revisions	Date	By/Par

Isometric View

Tél: (450) 979-4373 Fax: (450) 979-4626 www.exmweb.com		Flatness Aplatissement
		Max 3.0mm
Customer Client		Date
Drawn By Dessiné Par BoxCad: BoxCad		Date 15-Mar-21
Material Matière 14 Ga Cold Rolled A1008 CS Type B (1.7mm)		
Color Couleur White RAL9003 (Over Primer STK-P-04752)	Finish Fini Rough Textured	
Description 5300EWB 67" x 36" x 16" Cover		Detail Rev.
Part Number Numéro Pièce 5300EWB673616C		Rev. 7 0

SEE BILL OF MATERIAL ON LAST PAGE

This drawing is confidential and must not be reproduced or used without the consent of EXM

Ce dessin est confidentiel et ne doit pas être reproduit ou utilisé sans le consentement de EXM

STANDARD FEATURES ARE NOT LISTED IN THIS HOLE TABLE

HOLE TABLE - FRONT VIEW (CUSTOM FEATURE ONLY)

CUT-OUT	XDIM	YDIM	DESCRIPTION
1	17.959	1.435	STUD M6 x 18mm (Inside)

2	2.000	2.000	GND STUD M6 x 16mm (Inside)
3	34.494	62.553	LOCK 880 SCQ4-SL @ 0.0°
4	34.494	33.402	LOCK 880 SCQ4PL-SL @ 0.0°
5	34.494	4.250	LOCK 880 SCQ4-SL @ 0.0°

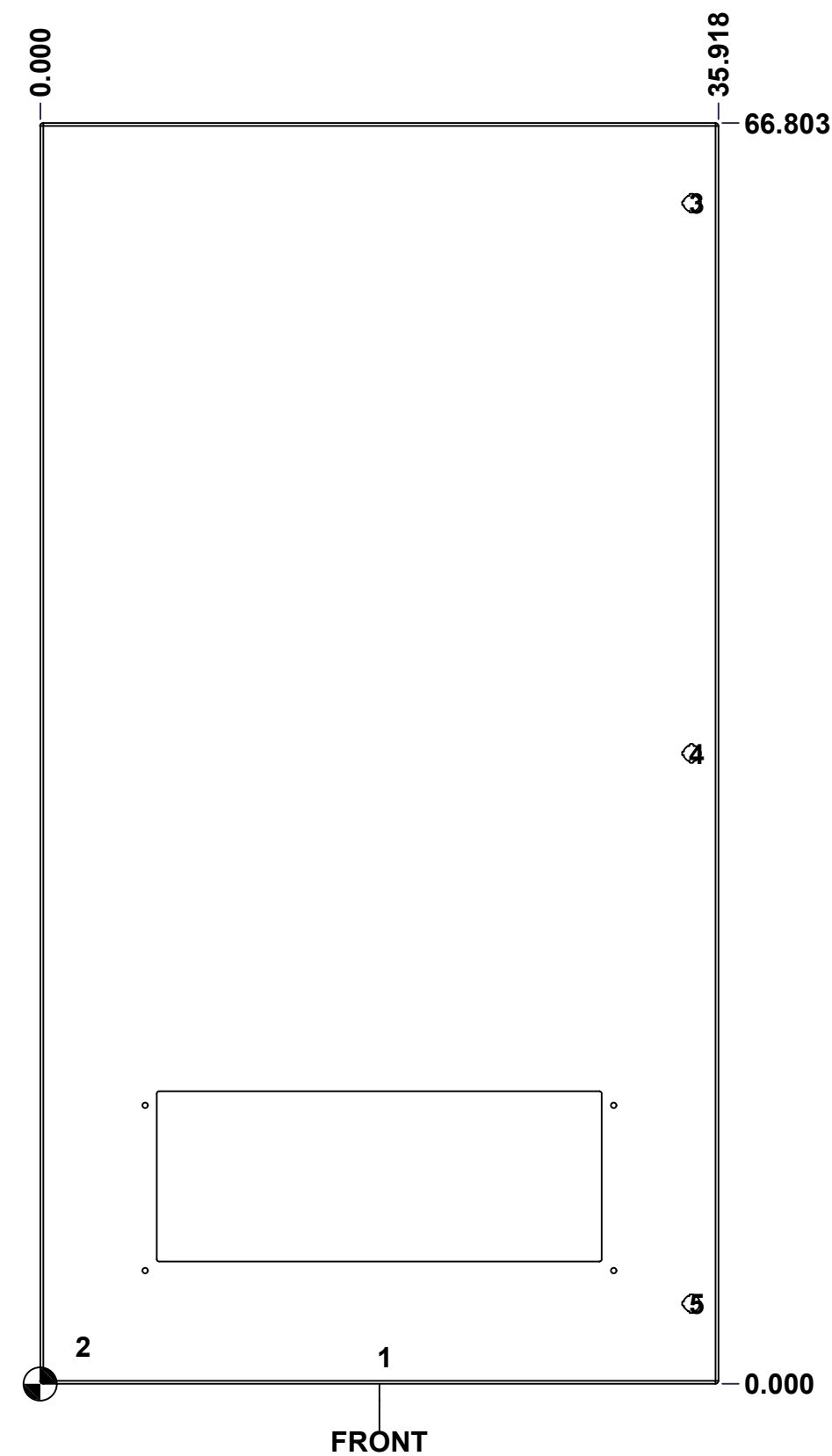

	Description	Status
	5300EWB 67" x 36" Cover	(NULL)
	Part Number Numéro Pièce	Rev.
	5300EWB673616C	0
		8
		9

This drawing is confidential and must not be reproduced or used without the consent of EXM

Ce dessin est confidentiel et ne doit pas être reproduit ou utilisé sans le consentement de EXM

No.	Revisions	Date	By/Par

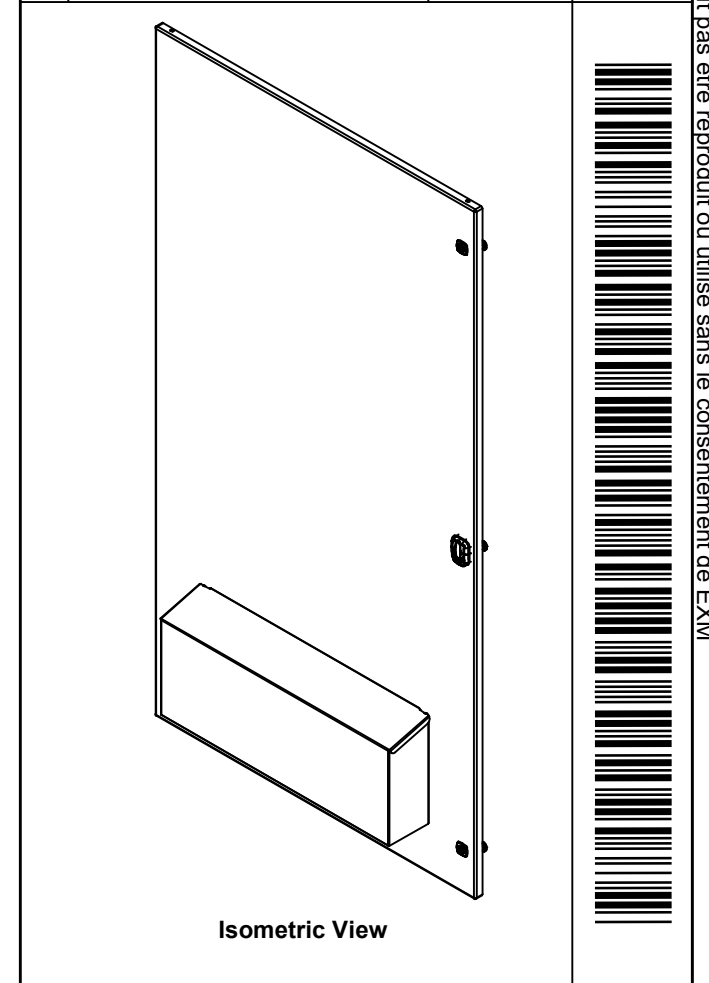

EXM
www.exmweb.com

Tél: (450) 979-4373
Fax: (450) 979-4626

Flatness
Aplatissement
Max 3.0mm

Projection

1	880 SCQ4PL-SL	3	5412 ES Padlockable 1/4 Turn Lock
2	STK-K-12500	18	5412 ES 1/4 Turn Lock
1	STK-Q-16080	0	Ground Stud M6 x 16mm Steel
1	STK-P-04752	0	Epoxy Primer Gray Powdura EAS6-C0000 (Bottom Layer)
1	STK-P-02401R	0	Powder Paint (White / Rough Textured)
1	5300EWB673616LPF	0	Filter 24.062" x 9.250"
1	5300EWB673616FPH585	0	5300EWB 67" x 36" x 16" Rain Hood
1	STK-Q-46515	3	5412 ES Door Support with Brass Insert
1	STK-Q-16055	1	M6 x 18mm Stud (No Paint Cap Required)
1	5300EWB673616G	0	5300EWB 67" x 36" Cover Gasket Part
4	STK-K-09800	10	5412 ES Hinge with 2 Captive Hinge Pins
1	5300EWB673616C-P	0	5300EWB 67" x 36" Cover Part

Customer Client	Date
Drawn By / Dessiné Par: BoxCad: BoxCad	Date: 15-Mar-21
Material / Matière: 14 Ga Cold Rolled A1008 CS Type B (1.7mm)	
Color / Couleur: White RAL9003 (Over Primer STK-P-04752)	Finish / Fini: Rough Textured
Description: 5300EWB 67" x 36" x 16" Cover	Detail Rev.
Part Number / Numéro Pièce: 5300EWB673616C	Rev. 9

Qty	Part Name	Rev	Description
Parts List			

Rev. 0	9
---------------	---