

This drawing is confidential and must not be reproduced or used without the consent of EXM

Ce dessin est confidentiel et ne doit pas être reproduit ou utilisé sans le consentement de EXM

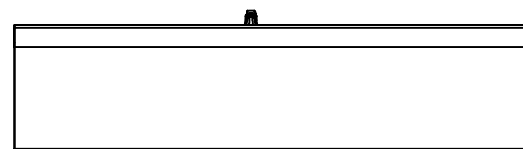

TOP

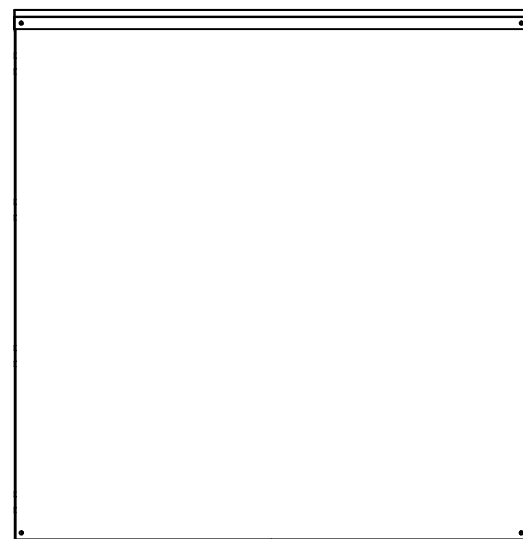

BACK

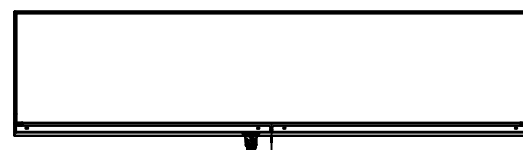

BOTTOM

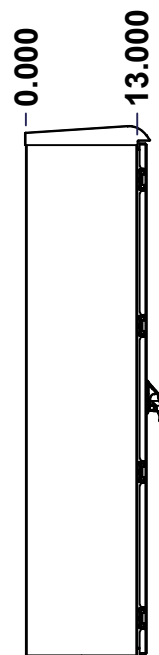

LEFT

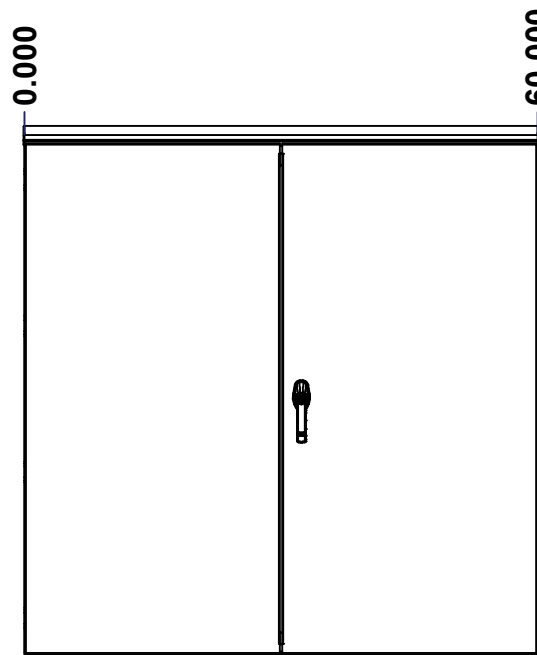

FRONT

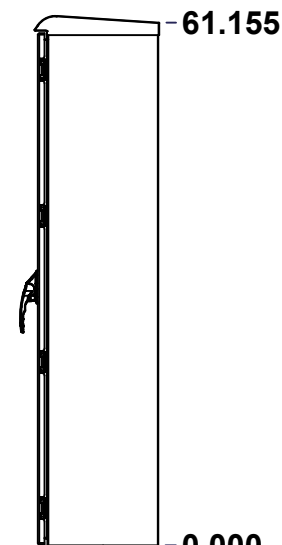

RIGHT

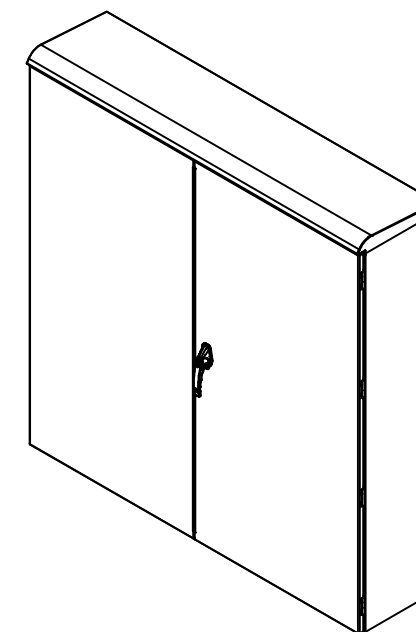

Isometric View



No.	Revisions	Date	By/Par

 Tél: (450) 979-4373  
 Fax: (450) 979-4626  
[www.exmweb.com](http://www.exmweb.com)

Flatness / Aplatissement: Max 3.0mm  
 Projection: 

Customer Client	Date
Drawn By / Dessiné Par: BoxCad: BoxCad	Date: 23-Sep-21

Material / Matière: 14 Ga Cold Rolled A1008 CS Type B (1.7mm)

Color / Couleur: Asa-61 Grey	Finish / Fini: Smooth
------------------------------	-----------------------

Description: 5300MCDD 60" x 60" x 13" Assembly

Part Number / Numéro Pièce: 5300MCDD606013	Rev. 0	1
--------------------------------------------	--------	---

SEE BILL OF MATERIAL ON LAST PAGE

This drawing is confidential and must not be reproduced or used without the consent of EXM

Ce dessin est confidentiel et ne doit pas être reproduit ou utilisé sans le consentement de EXM

NOTE	
ITEM	DESCRIPTION
1	NEMA 3, 3R Enclosure (IP64)
2	C/W Standard ground studs on box and cover
3	W/O Standard door stiffener
4	C/W Special inner panel (Sold separately)
5	C/W Standard inner panel mounting studs

No.	Revisions	Date	By/Par

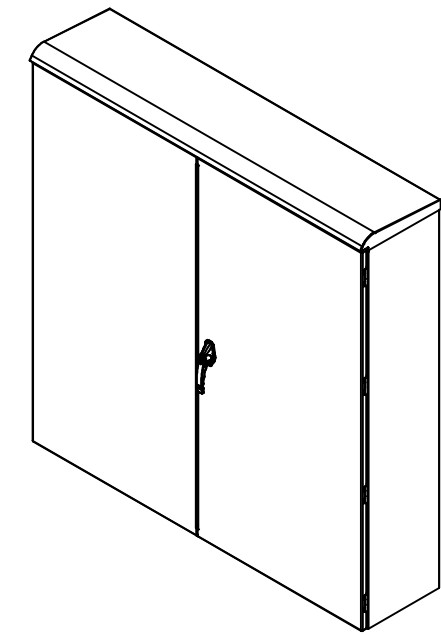

Isometric View

PACKING		
ITEM	QTY	DESCRIPTION
Cardboard sleeve	2	Top and Bottom
Cardboard strip	2	Between back of enclosure and inner panel
Plastic bag	1	To protect cover surface and inside gasket
Cardboard corner	4	To reinforced for the plastic strap tightening
Plastic strap - Black	2	To Squeeze 2 cardboard sleeve together
Packaging label	3	White label with PN
Plastic strap- Green	2	To secure the enclosure to the wood pallet
Wood Pallet	1	2" deeper and 3" larger than enclosure size

Qty	Part Number	Rev	Description
1	5300MCDD606013IP	0	5300MCDD 60" x 60" Inner Panel Part
4	STK-K-01320	0	5412 ES Inner Panel Accessory Kit
1	5300MCDD606013LD	0	5300MCDD 60" x 60" Lock Door
1	5300MCDD606013FD	0	5300MCDD 60" x 60" Flange Door
1	5300MCDD606013B	0	5300MCDD 60" x 60" x 13" Body
8	STK-Q-04050-10	8	M6 x 10mm Hexagon Socket Head Machine Screw with Nyseal
Parts List			

		Flatness Aplatissement Max 3.0mm	
Tél: (450) 979-4373 Fax: (450) 979-4626 <a href="http://www.exmweb.com">www.exmweb.com</a>		Projection 	
Customer Client		Date	
Drawn By Dessiné Par BoxCad: BoxCad		Date 23-Sep-21	
Material Matière 14 Ga Cold Rolled A1008 CS Type B (1.7mm)			
Color Couleur Asa-61 Grey		Finish Fini Smooth	
Description 5300MCDD 60" x 60" x 13" Assembly			Detail Rev.
Part Number Numéro Pièce 5300MCDD606013		Rev. 0	2 / 15

This drawing is confidential and must not be reproduced or used without the consent of EXM

Ce dessin est confidentiel et ne doit pas être reproduit ou utilisé sans le consentement de EXM

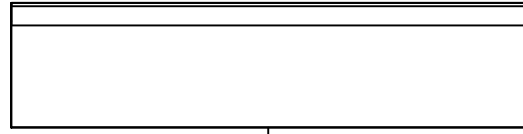

TOP

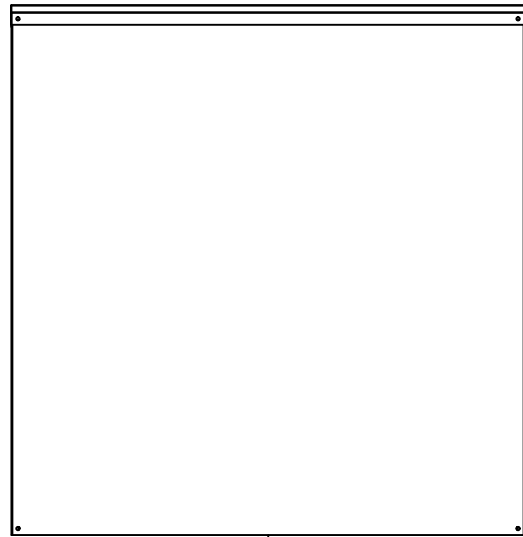

BACK

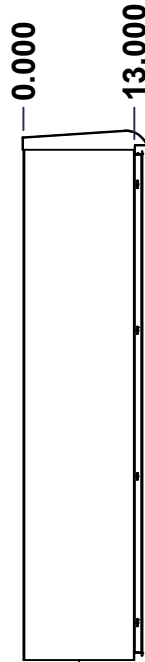

LEFT

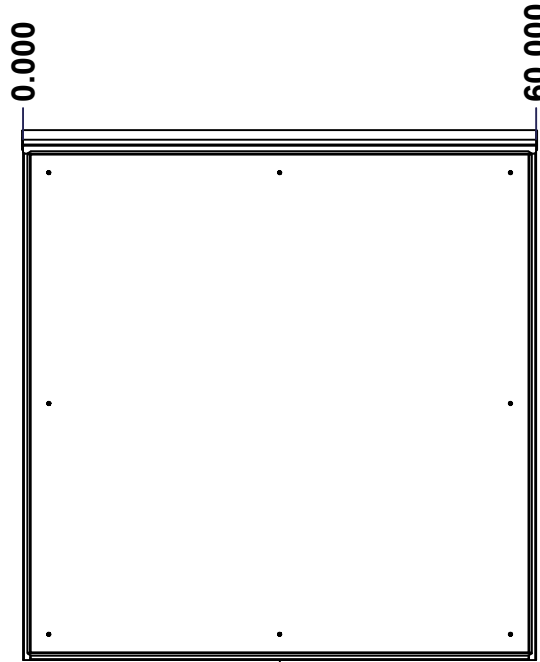

FRONT

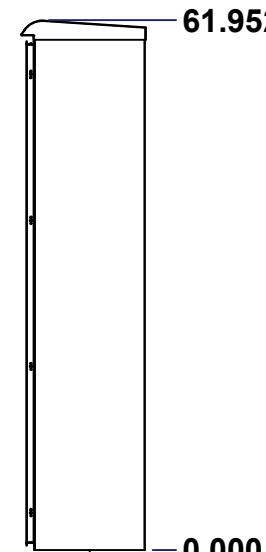

RIGHT



BOTTOM

No.	Revisions	Date	By/Par

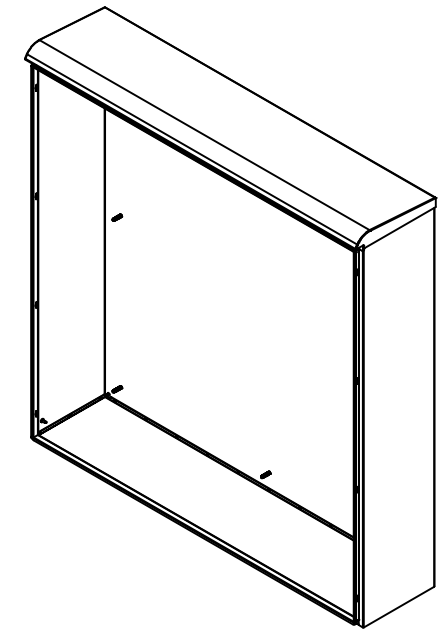

Isometric View



Tél: (450) 979-4373  
 Fax: (450) 979-4626  
[www.exmweb.com](http://www.exmweb.com)

Flatness  
Aplatissement

Max 3.0mm

Projection



Customer Client	Date
Drawn By Dessiné Par BoxCad: BoxCad	Date 23-Sep-21
Material Matière 14 Ga Cold Rolled A1008 CS Type B (1.7mm)	
Color Couleur Asa-61 Grey	Finish Fini Smooth
Description 5300MCDD 60" x 60" x 13" Body	Detail Rev.
Part Number Numéro Pièce <b>5300MCDD606013B</b>	Rev. 3
	0

SEE BILL OF MATERIAL ON LAST PAGE

This drawing is confidential and must not be reproduced or used without the consent of EXM

Ce dessin est confidentiel et ne doit pas être reproduit ou utilisé sans le consentement de EXM

STANDARD FEATURES ARE NOT LISTED IN THIS HOLE TABLE			
HOLE TABLE - RIGHT VIEW (CUSTOM FEATURE ONLY)			
CUT-OUT	XDIM	YDIM	DESCRIPTION
1	11.500	2.000	GND STUD M6 x 16mm (Inside)

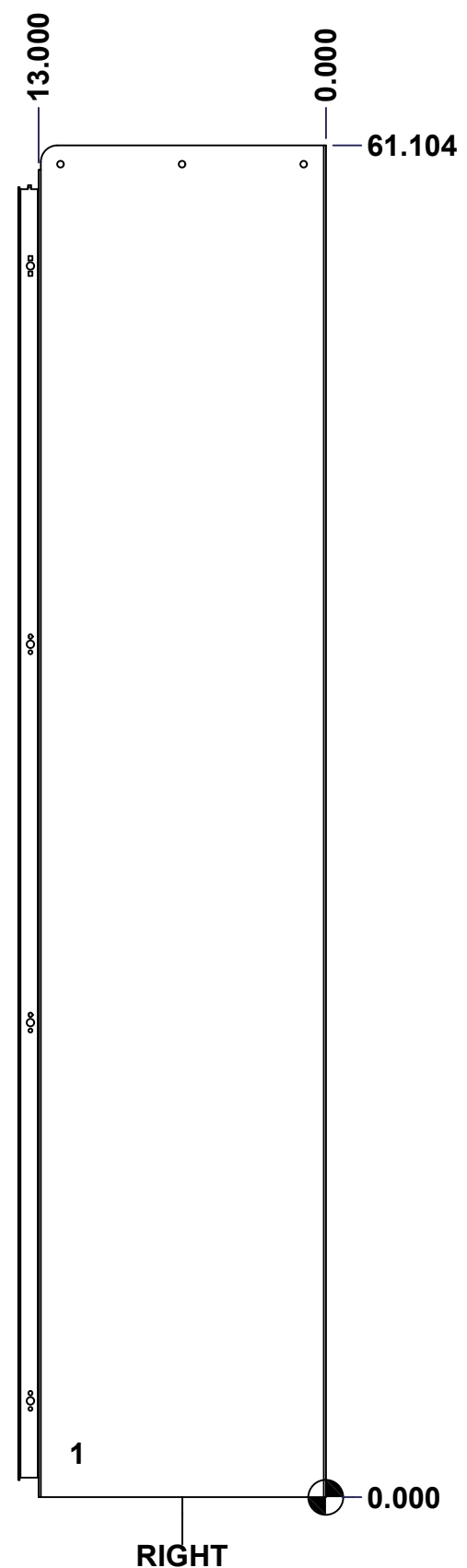

	Description	Status	
	5300MCDD 60" x 60" x 13" Body	(NULL)	
	Part Number Numéro Pièce	Rev.	
	<b>5300MCDD606013B</b>	<b>0</b>	4
			15

This drawing is confidential and must not be reproduced or used without the consent of EXM

Ce dessin est confidentiel et ne doit pas être reproduit ou utilisé sans le consentement de EXM

**STANDARD FEATURES ARE NOT LISTED IN THIS HOLE TABLE**

**HOLE TABLE - LEFT VIEW (CUSTOM FEATURE ONLY)**

CUT-OUT	XDIM	YDIM	DESCRIPTION
1	11.500	2.000	GND STUD M6 x 16mm (Inside)

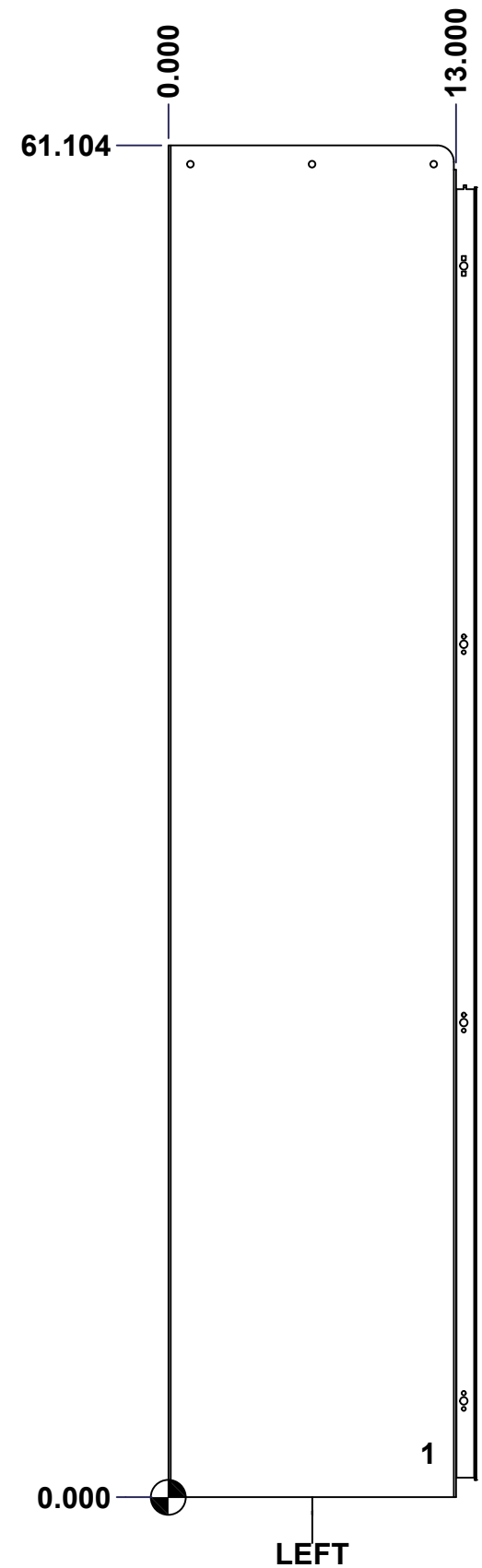

	Description	Status	
	5300MCDD 60" x 60" x 13" Body	(NULL)	
	Part Number Numéro Pièce	Rev.	5
	<b>5300MCDD606013B</b>	<b>0</b>	15

This drawing is confidential and must not be reproduced or used without the consent of EXM

Ce dessin est confidentiel et ne doit pas être reproduit ou utilisé sans le consentement de EXM

**STANDARD FEATURES ARE NOT LISTED IN THIS HOLE TABLE**

**HOLE TABLE - BACK VIEW (CUSTOM FEATURE ONLY)**

CUT-OUT	XDIM	YDIM	DESCRIPTION
1	3.000	3.000	IP STUD M8 x 35mm (Inside)
2	3.000	57.000	IP STUD M8 x 35mm (Inside)
3	57.000	57.000	IP STUD M8 x 35mm (Inside)
4	57.000	3.000	IP STUD M8 x 35mm (Inside)
5	3.000	30.000	IP STUD M8 x 35mm (Inside)
6	57.000	30.000	IP STUD M8 x 35mm (Inside)
7	30.000	3.000	IP STUD M8 x 35mm (Inside)
8	30.000	57.000	IP STUD M8 x 35mm (Inside)
-----			
9	59.250	0.750	RND Ø0.390
10	59.250	60.400	RND Ø0.500
11	0.750	60.400	RND Ø0.500
12	0.750	0.750	RND Ø0.390

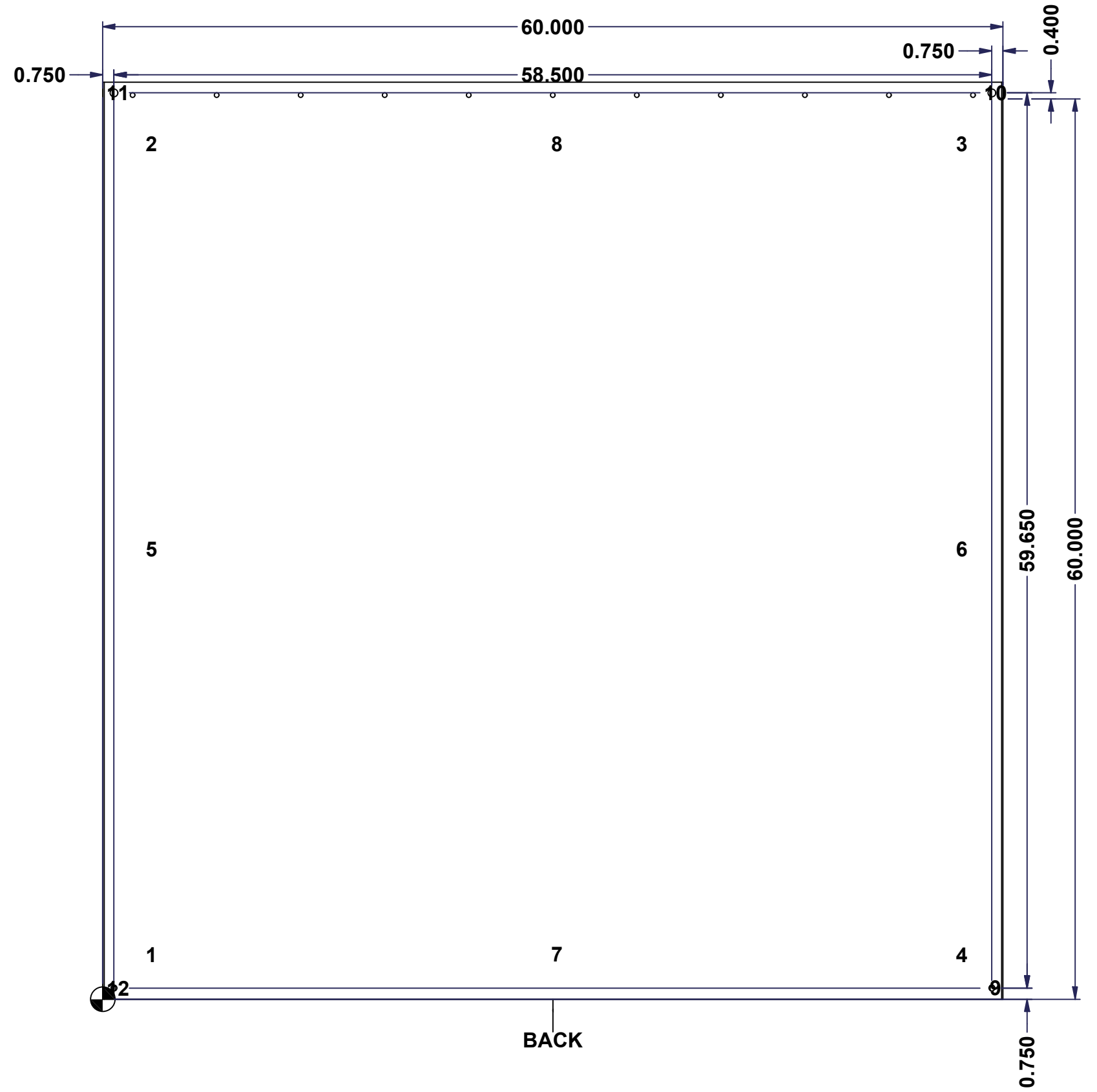

	Description	Status
	5300MCDD 60" x 60" x 13" Body	(NULL)
	Part Number Numéro Pièce	Rev.
	<b>5300MCDD606013B</b>	<b>0</b> / 6
		15

This drawing is confidential and must not be reproduced or used without the consent of EXM

Ce dessin est confidentiel et ne doit pas être reproduit ou utilisé sans le consentement de EXM

No.	Revisions	Date	By/Par

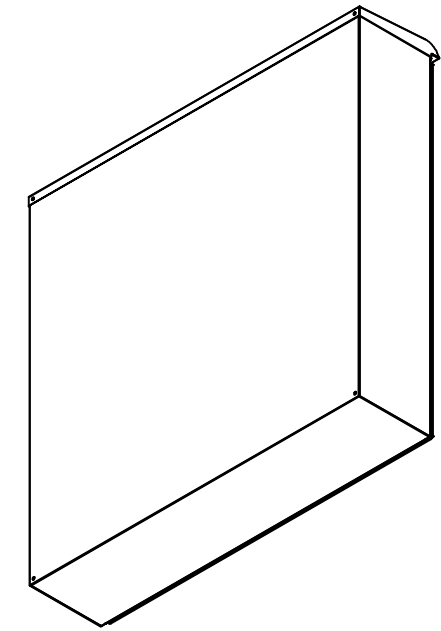

Isometric View

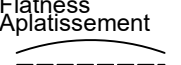

 Tél: (450) 979-4373 Fax: (450) 979-4626 <a href="http://www.exmweb.com">www.exmweb.com</a>		Flatness Aplatissement  Max 3.0mm
Customer Client		Date
Drawn By Dessiné Par BoxCad: BoxCad		Date 23-Sep-21
Material Matière 14 Ga Cold Rolled A1008 CS Type B (1.7mm)		
Color Couleur Asa-61 Grey		Finish Fini Smooth
Description 5300MCDD 60" x 60" x 13" Body		Detail Rev.
Part Number Numéro Pièce <b>5300MCDD606013B</b>		Rev. 7 <b>0</b>

Qty	Part Number	Rev	Description
2	STK-Q-16080	0	Ground Stud M6 x 16mm Steel
1	STK-P-02400S	0	Powder Paint (Asa-61 Grey / Smooth)
1	5300MCDD606013BT-P	0	5300MCDD 60" x 13" Bottom Part
8	STK-Q-16005	0	Stud M8 x 35mm Steel
1	5300MCDD606013T-P	0	5300MCDD 60" x 8" Top Part
1	5300MCDD606013B-P	0	5300MCDD 60" x 60" x 13" Body Part
Parts List			

This drawing is confidential and must not be reproduced or used without the consent of EXM

Ce dessin est confidentiel et ne doit pas être reproduit ou utilisé sans le consentement de EXM

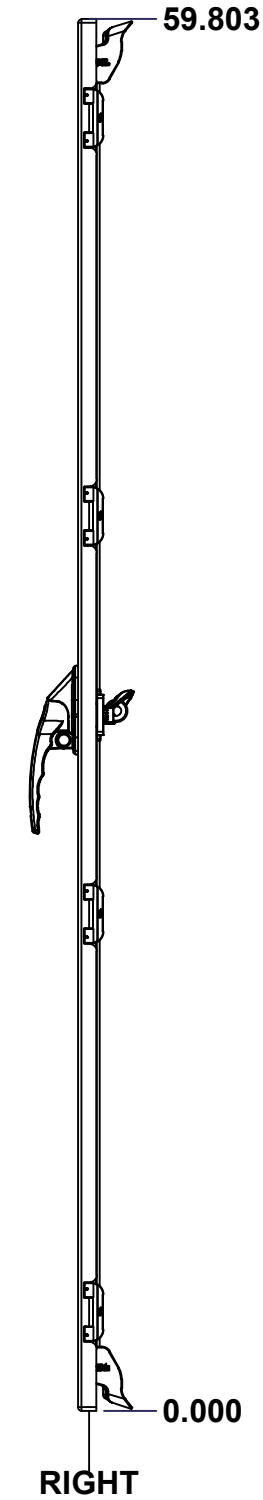
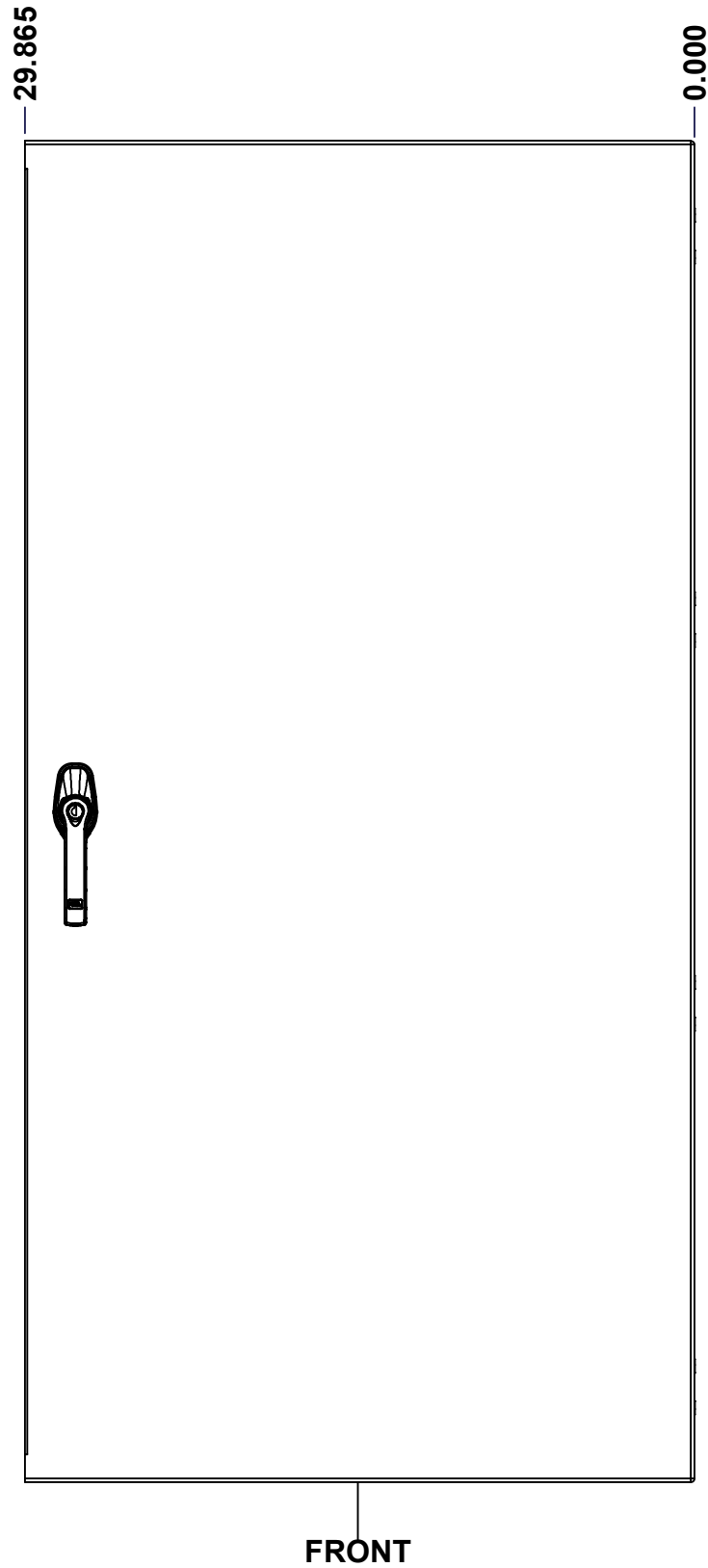
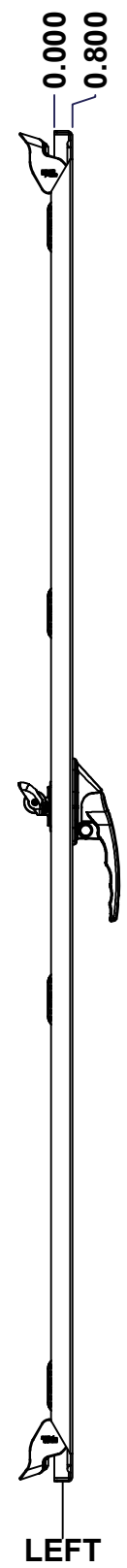
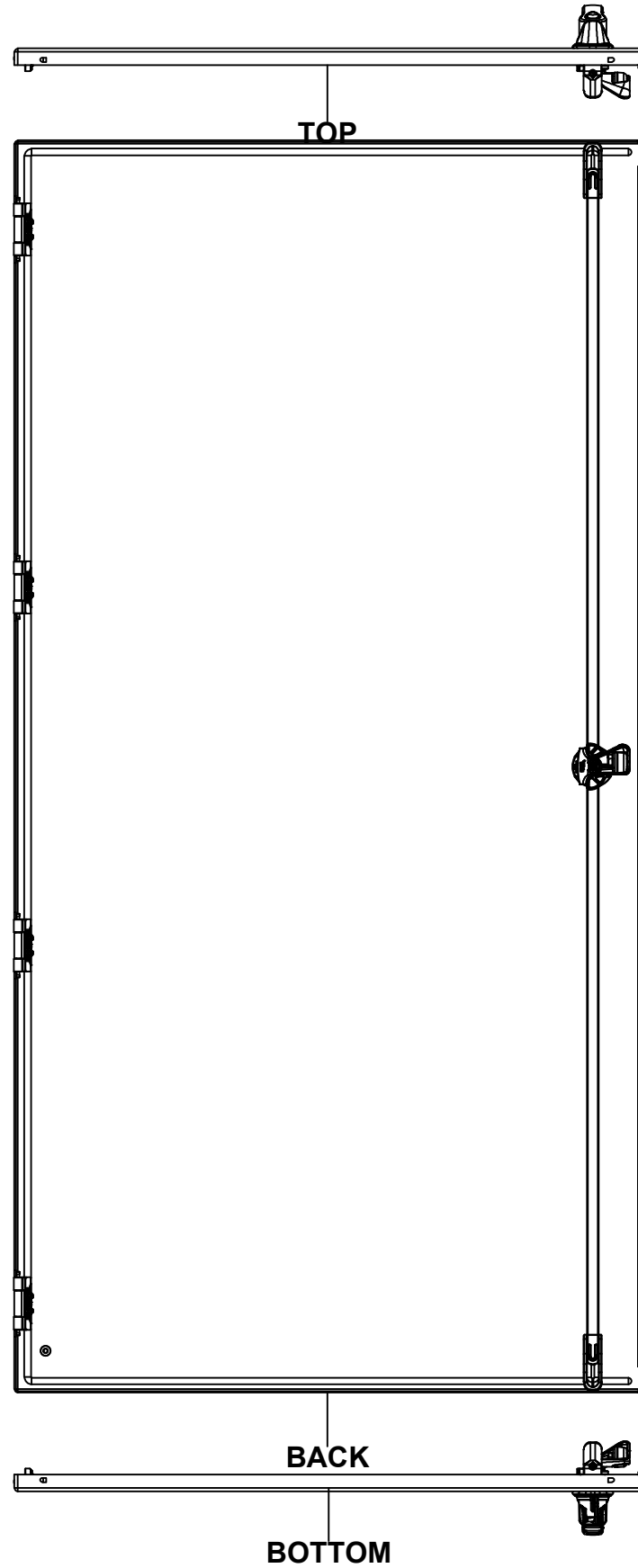

No.	Revisions	Date	By/Par

Isometric View

<p>Tél: (450) 979-4373 Fax: (450) 979-4626 <a href="http://www.exmweb.com">www.exmweb.com</a></p>		Flatness Aplatissement	
		Max 3.0mm	
Customer Client Drawn By / Dessiné Par: BoxCad: BoxCad Material / Matière: 14 Ga Cold Rolled A1008 CS Type B (1.7mm)		Projection	
Date		Date	
Date 23-Sep-21		Date	
Color / Couleur: Asa-61 Grey		Finish / Fini: Smooth	
Description: 5300MCDD 60" x 60" Lock Door		Detail Rev.	
Part Number / Numéro Pièce: 5300MCDD606013LD		Rev.:	8
SEE BILL OF MATERIAL ON LAST PAGE		0	15

This drawing is confidential and must not be reproduced or used without the consent of EXM

Ce dessin est confidentiel et ne doit pas être reproduit ou utilisé sans le consentement de EXM

**STANDARD FEATURES ARE NOT LISTED IN THIS HOLE TABLE**

**HOLE TABLE - FRONT VIEW (CUSTOM FEATURE ONLY)**

CUT-OUT	XDIM	YDIM	DESCRIPTION
1	27.615	54.896	CLOSING BAR STUD (Inside)
2	27.615	4.907	CLOSING BAR STUD (Inside)
-----			
3	1.486	2.000	GND STUD M6 x 16mm (Inside)
4	27.615	29.902	HANDLE 885 ESL2A-APHK @ 0.0°

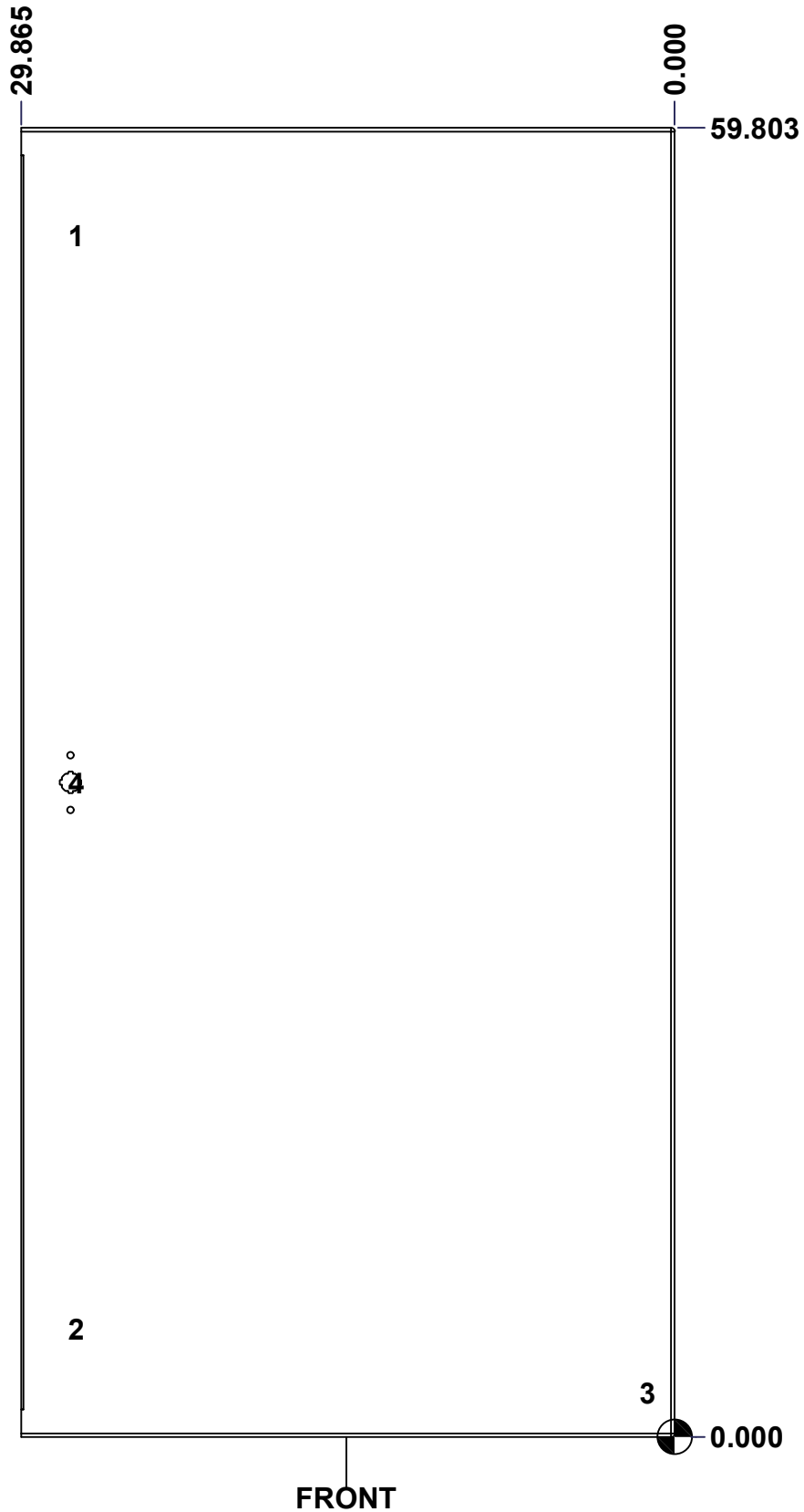

	Description	Status
	5300MCDD 60" x 60" LD	(NULL)
	Part Number Numéro Pièce	Rev.
	<b>5300MCDD606013LD</b>	<b>0</b> / 9
		15

This drawing is confidential and must not be reproduced or used without the consent of EXM

Ce dessin est confidentiel et ne doit pas être reproduit ou utilisé sans le consentement de EXM

No.	Revisions	Date	By/Par

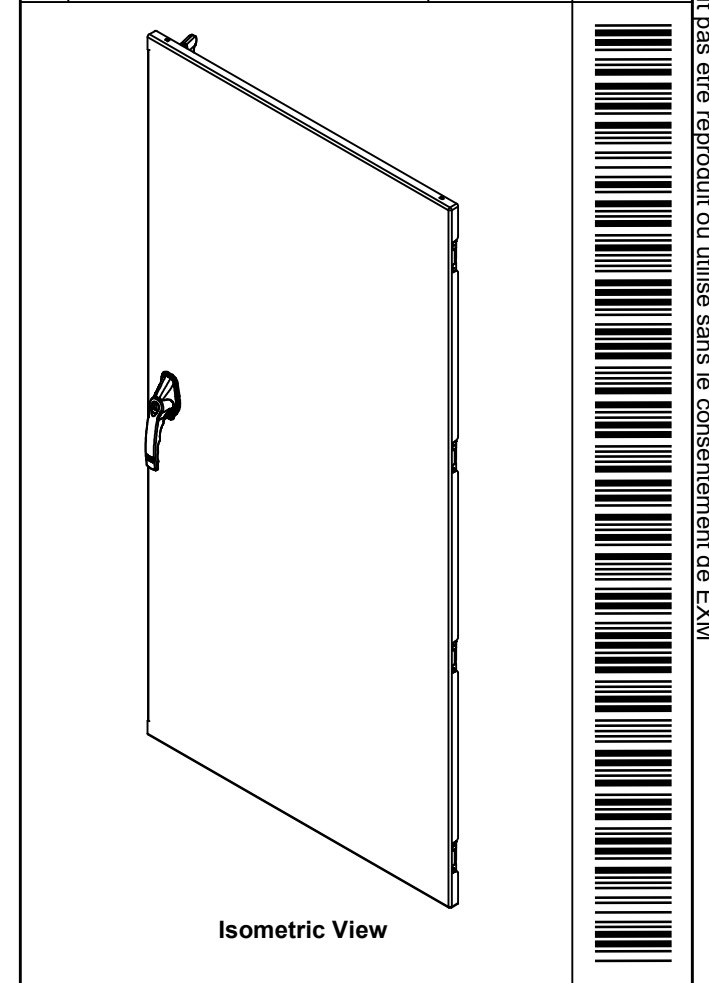

**EXM**  
exm

Tél: (450) 979-4373  
Fax: (450) 979-4626  
[www.exmweb.com](http://www.exmweb.com)

Flatness  
Aplatissement  
Max 3.0mm

Projection

2	STK-Q-90042	4	5412 ES - Cabinet Closing Bar End (Small)
2	STK-Q-45655-60	0	5412 ES - Closing Bar
1	STK-A-50535	15	5412 ES Handle Cam Assembly (Left Side, Grip 32mm)
1	STK-Q-90051	3	5412 ES - Handle Cam Spacer
1	885ESL2A-APHK	7	885 ESL2A-APHK - Zinc Die Cast L-Handle Padlockable Assy
1	STK-Q-16080	0	Ground Stud M6 x 16mm Steel
2	STK-Q-16405	7	Guide Stud - Small (No Paint Cap Required)
1	5300MCDD606013LD-G	0	5300MCDD 60" x 60" Lock Door Gasket
1	5300MCDD606013LD-P	0	5300MCDD 60" x 60" Lock Door
4	STK-K-09800	10	5412 ES Hinge with 2 Captive Hinge Pins
2	STK-Q-07220	1	M6 Nylon Insert Lock Nut

Customer Client	Date
Drawn By Dessiné Par BoxCad: BoxCad	Date 23-Sep-21
Material Matière 14 Ga Cold Rolled A1008 CS Type B (1.7mm)	
Color Couleur Asa-61 Grey	Finish Fini Smooth
Description 5300MCDD 60" x 60" Lock Door	Detail Rev.
Part Number Numéro Pièce <b>5300MCDD606013LD</b>	Rev. 10 <b>0</b> 15

Qty	Part Name	Rev	Description
Parts List			

This drawing is confidential and must not be reproduced or used without the consent of EXM

Ce dessin est confidentiel et ne doit pas être reproduit ou utilisé sans le consentement de EXM

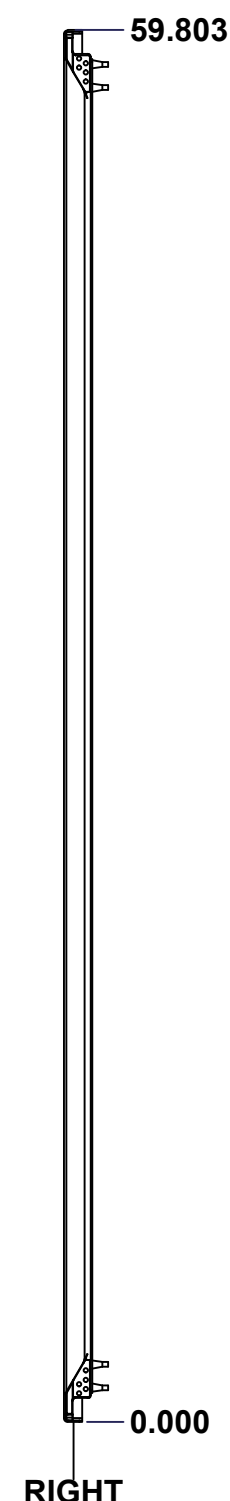
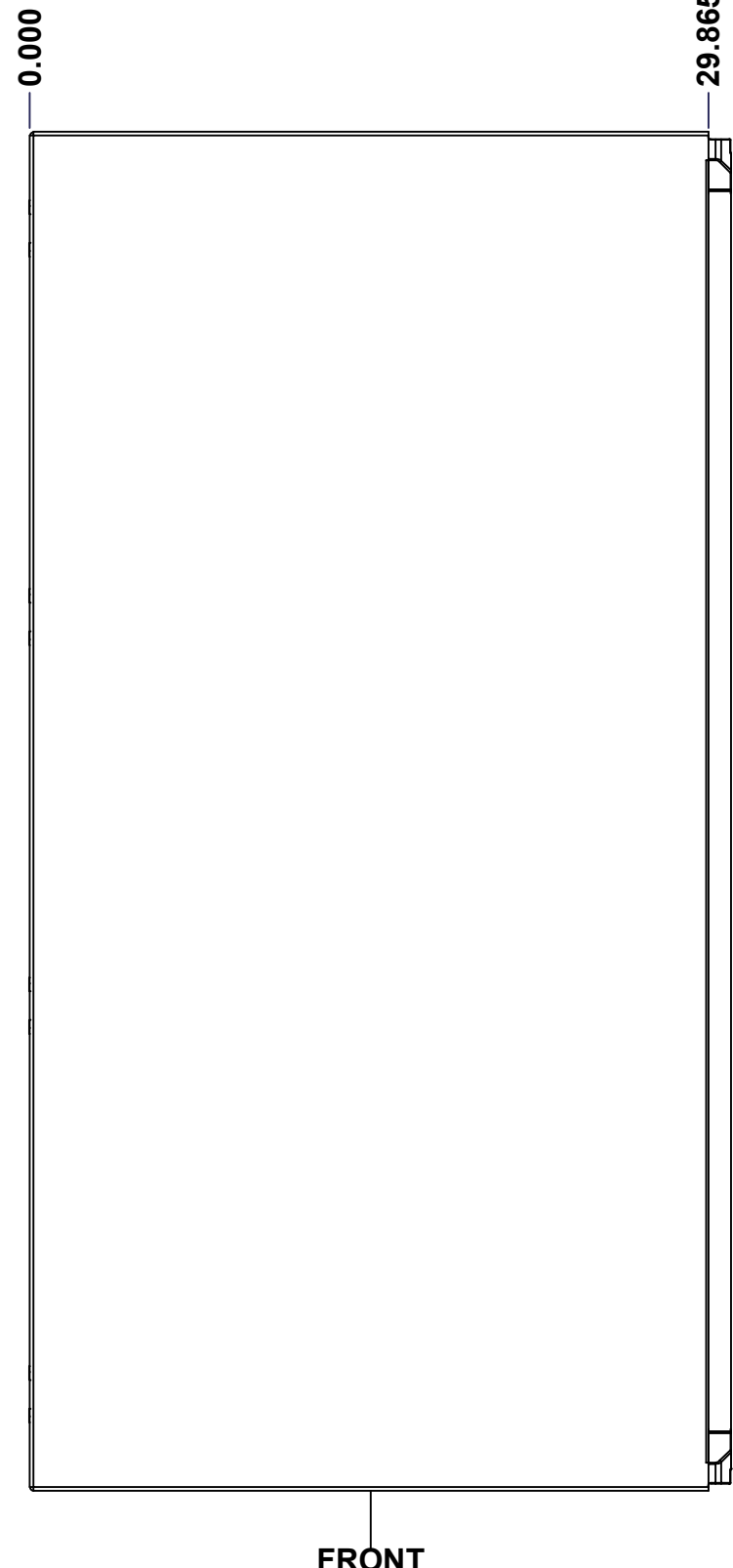
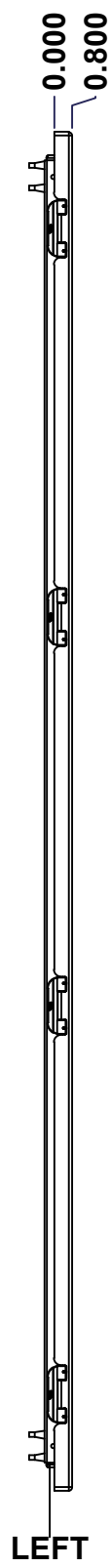
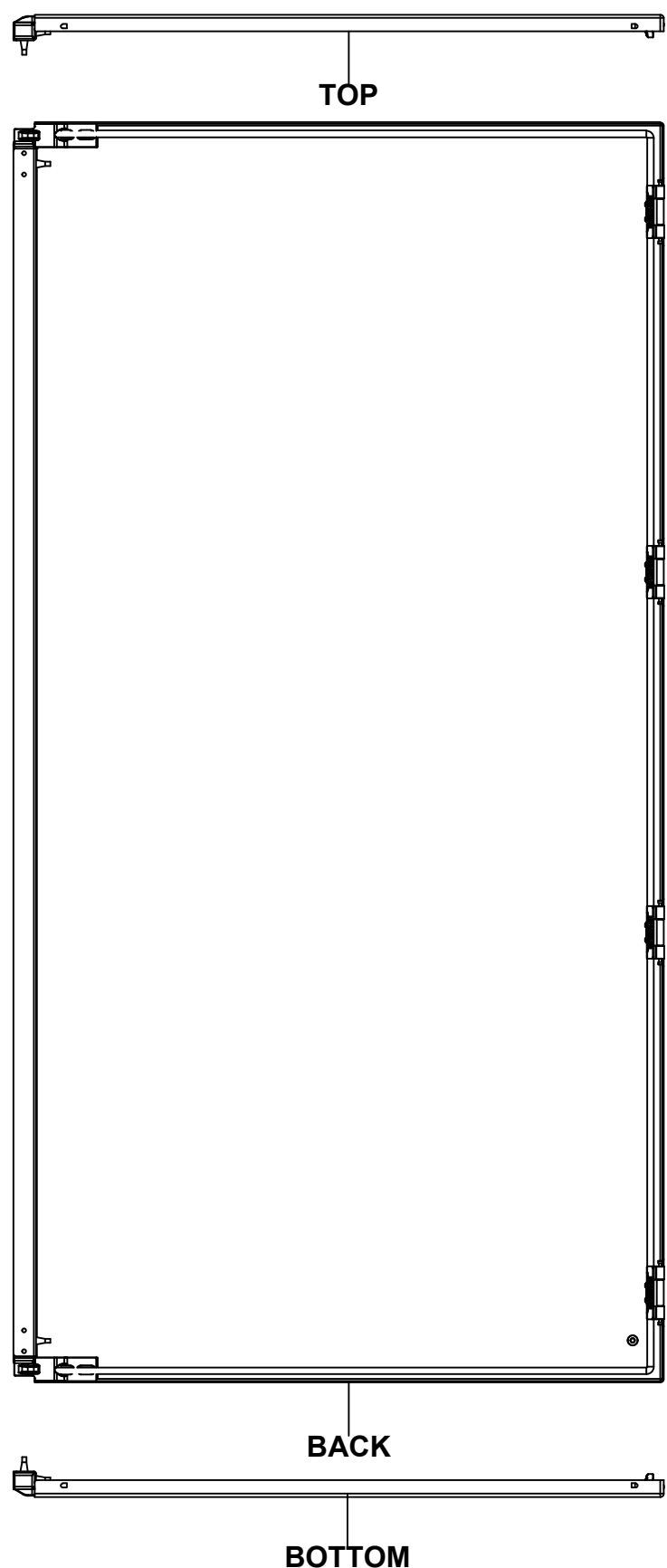

No.	Revisions	Date	By/Par

Isometric View

<p>Tél: (450) 979-4373                  Fax: (450) 979-4626  <a href="http://www.exmweb.com">www.exmweb.com</a></p>		Flatness Aplatissement Max 3.0mm Projection 
Customer Client	Date	
Drawn By Dessiné Par	BoxCad: BoxCad	Date 23-Sep-21
Material Matière	14 Ga Cold Rolled A1008 CS Type B (1.7mm)	
Color Couleur	Asa-61 Grey	Finish Fini Smooth
Description	Detail Rev.	
5300MCDD 60" x 60" Flange Door		
Part Number Numéro Pièce	Rev. 0	11 / 15

SEE BILL OF MATERIAL ON LAST PAGE

**5300MCDD606013FD**

This drawing is confidential and must not be reproduced or used without the consent of EXM

Ce dessin est confidentiel et ne doit pas être reproduit ou utilisé sans le consentement de EXM

**STANDARD FEATURES ARE NOT LISTED IN THIS HOLE TABLE**

**HOLE TABLE - FRONT VIEW (CUSTOM FEATURE ONLY)**

CUT-OUT	XDIM	YDIM	DESCRIPTION
1	1.486	2.000	GND STUD M6 x 16mm (Inside)

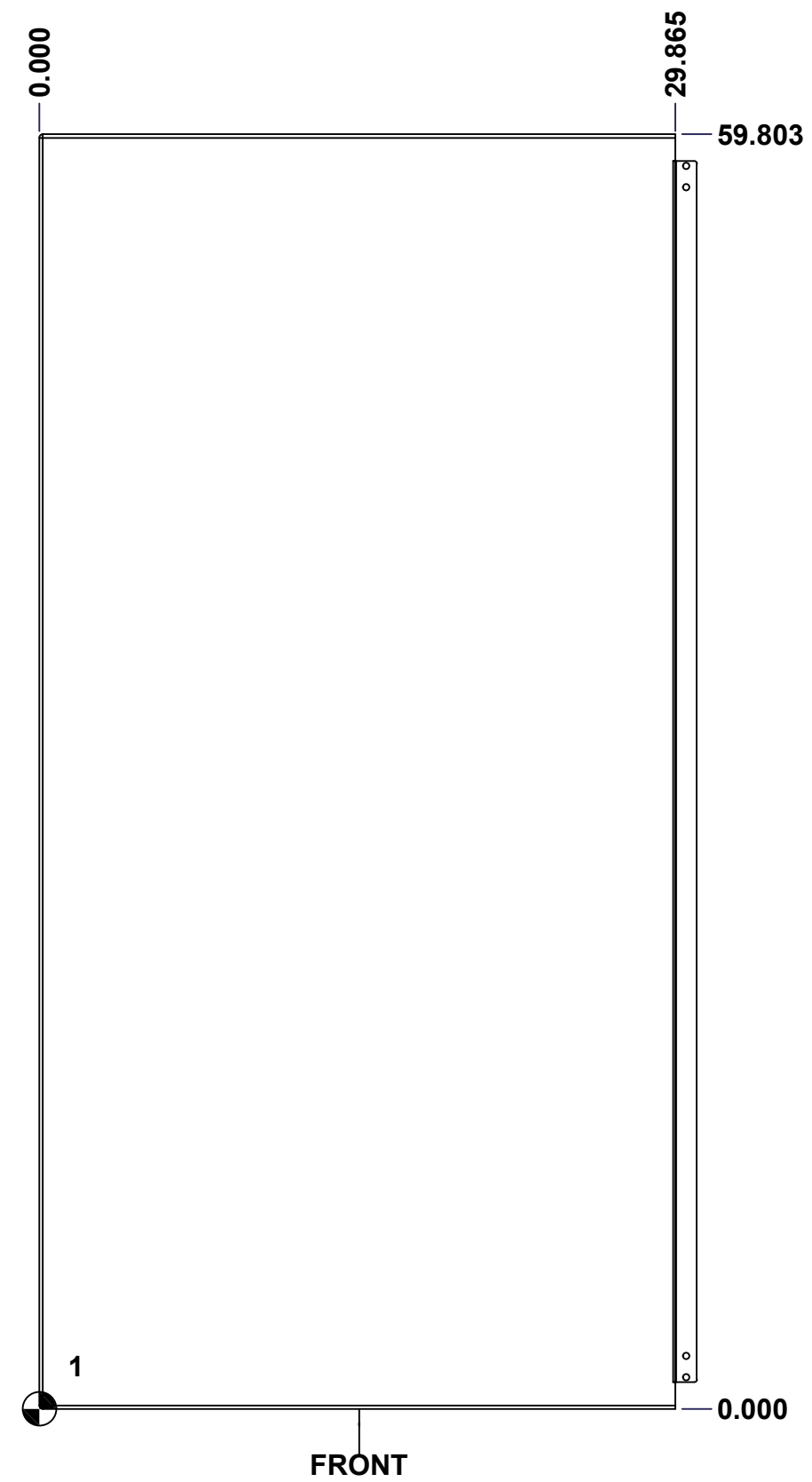

	Description	Status
	5300MCDD 60" x 60" Flange Door	(NULL)
Part Number Numéro Pièce <b>5300MCDD606013FD</b>	Rev.	12
	<b>0</b>	15

This drawing is confidential and must not be reproduced or used without the consent of EXM

Ce dessin est confidentiel et ne doit pas être reproduit ou utilisé sans le consentement de EXM

No.	Revisions	Date	By/Par

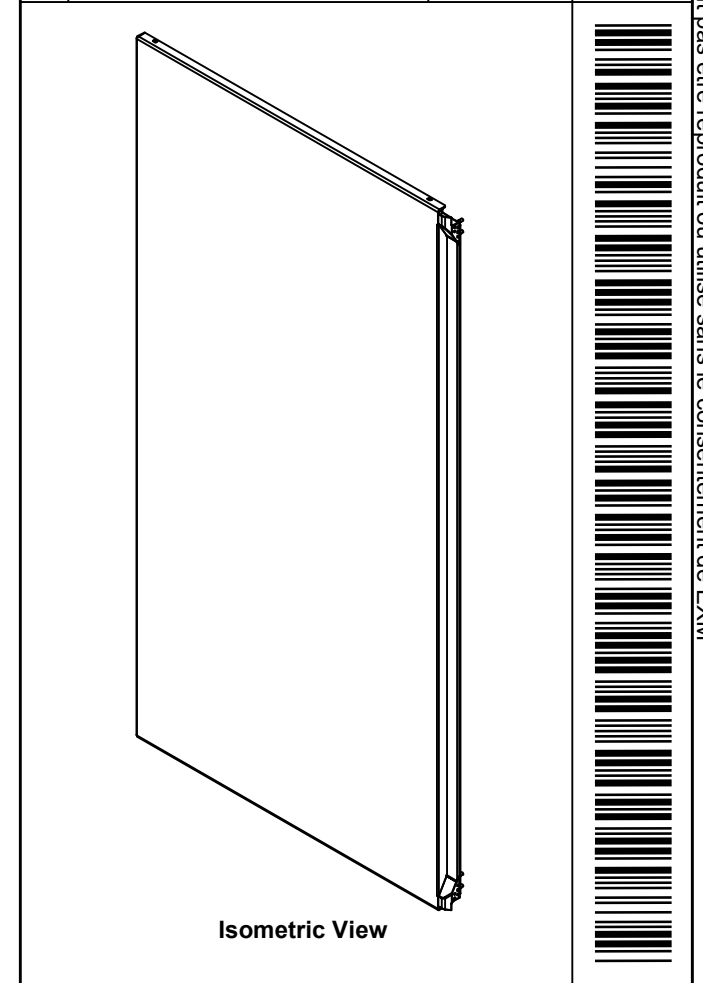

**EXM**  
www.exmweb.com

Tél: (450) 979-4373  
Fax: (450) 979-4626

Flatness  
Aplatissement  
Max 3.0mm

Projection

Customer Client	Date
Drawn By / Dessiné Par: BoxCad: BoxCad	Date: 23-Sep-21

Material / Matière	14 Ga Cold Rolled A1008 CS Type B (1.7mm)
Color / Couleur	Asa-61 Grey
Finish / Fini	Smooth

Description	5300MCDD 60" x 60" Flange Door	Detail Rev.
Part Number / Numéro Pièce	<b>5300MCDD606013FD</b>	Rev. 0

Qty	Part Name	Rev	Description
1	STK-Q-16080	0	Ground Stud M6 x 16mm Steel
1	STK-P-02400S	0	Powder Paint (Asa-61 Grey / Smooth)
1	STK-G-00701	0	1" x 1/4" Self-Adhesive Neoprene Gasket
1	STK-G-03200	8	5500 ESDD Lower Flange Door Gasket
1	STK-G-03100	8	5500 ESDD Upper Flange Door Gasket
1	5300MCDD606013FD-G	0	5300MCDD 60" x 60" Flange Door Gasket
1	5300MCDD606013FD-P	0	5300MCDD 60" x 60" Flange Door Part
4	STK-K-09800	10	5412 ES Hinge with 2 Captive Hinge Pins
Parts List			

This drawing is confidential and must not be reproduced or used without the consent of EXM

Ce dessin est confidentiel et ne doit pas être reproduit ou utilisé sans le consentement de EXM



TOP

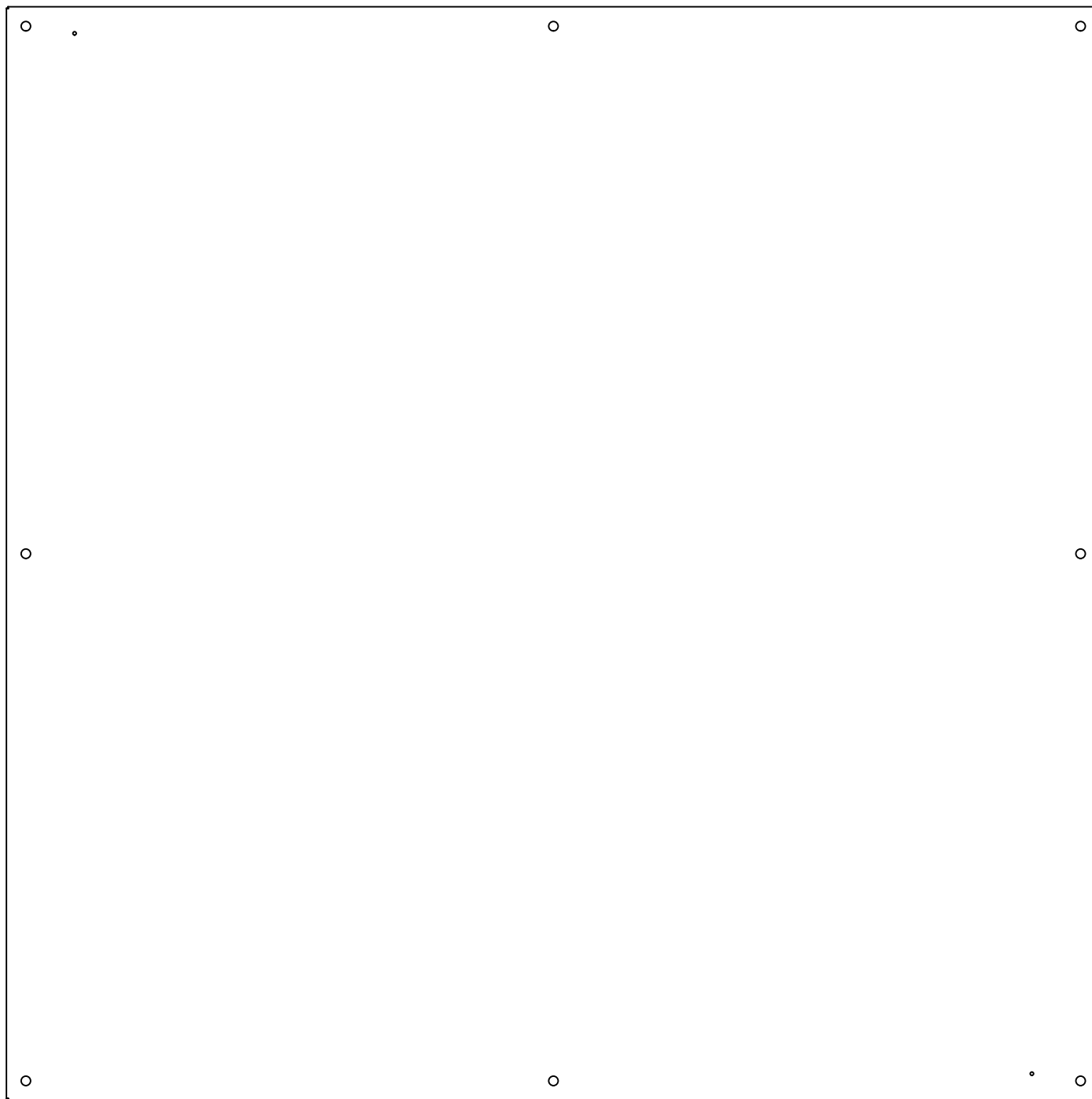

FRONT

56.000

0.000

RIGHT

SEE BILL OF MATERIAL ON LAST PAGE

No.	Revisions	Date	By/Par

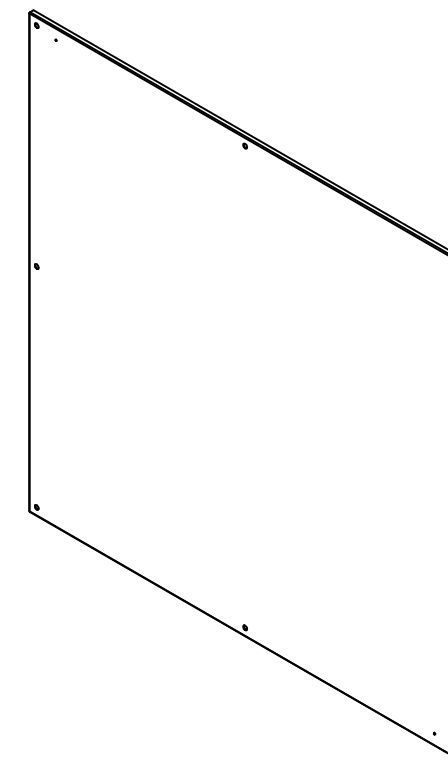

Isometric View



Tél: (450) 979-4373  
 Fax: (450) 979-4626  
[www.exmweb.com](http://www.exmweb.com)

Flatness  
Aplatissement

Max 3.0mm

Projection



Customer Client	Date
Drawn By / Dessiné Par: BoxCad: BoxCad	Date: 23-Sep-21
Material / Matière: 14 Ga Galvanized	
Color / Couleur: Unpainted	Finish / Fini: Unpainted

Description: 5300MCDD 60" x 60" Inner Panel Part	Detail Rev.
Part Number / Numéro Pièce: 5300MCDD606013IP	Rev. 0

Rev. 14
15

This drawing is confidential and must not be reproduced or used without the consent of EXM

Ce dessin est confidentiel et ne doit pas être reproduit ou utilisé sans le consentement de EXM

No.	Revisions	Date	By/Par

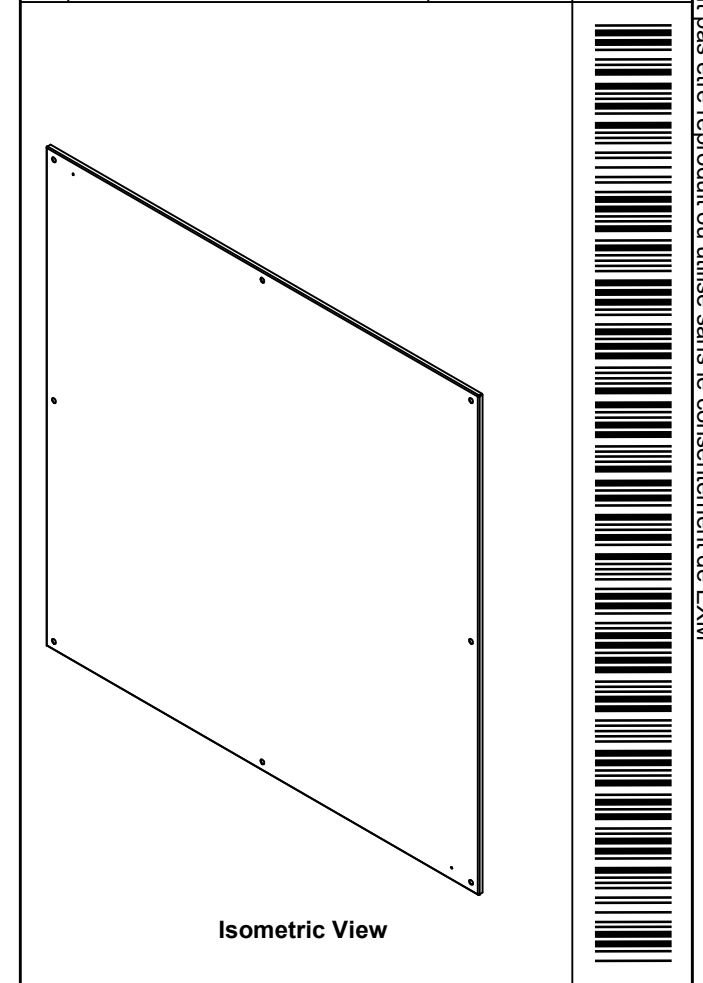

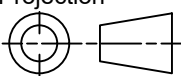
 Tél: (450) 979-4373 Fax: (450) 979-4626 <a href="http://www.exmweb.com">www.exmweb.com</a>		Flatness Aplatissement Max 3.0mm
Customer Client		Projection 
Drawn By / Dessiné Par: BoxCad: BoxCad		Date: 23-Sep-21
Material / Matière: 14 Ga Galvanized		
Color / Couleur: Unpainted	Finish / Fini: Unpainted	
Description: 5300MCDD 60" x 60" Inner Panel Part		Detail Rev.
Part Number / Numéro Pièce: <b>5300MCDD606013IP</b>		Rev. 0 / 15

Qty	Part Number	Rev	Description
1	5300MCDD606013IP-P	0	5300MCDD 60" x 60" Inner Panel Part
Parts List			