

This drawing is confidential and must not be reproduced or used without the consent of EXM

Ce dessin est confidentiel et ne doit pas être reproduit ou utilisé sans le consentement de EXM

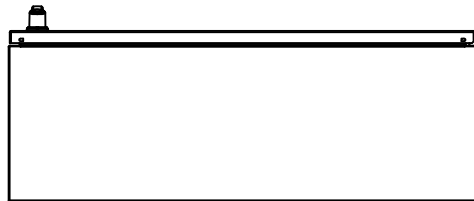

TOP

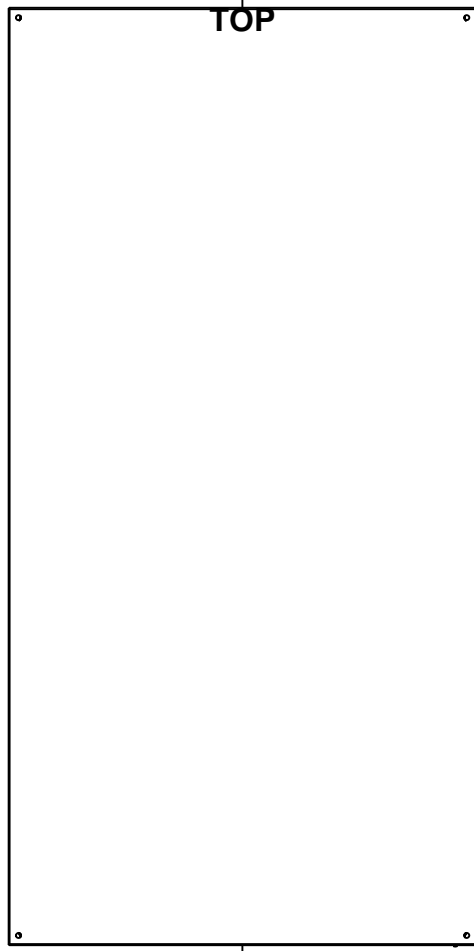

BACK

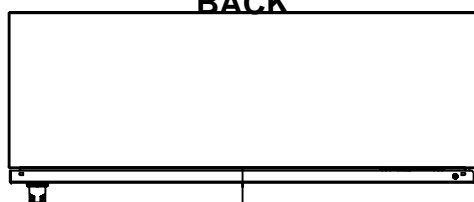

BOTTOM

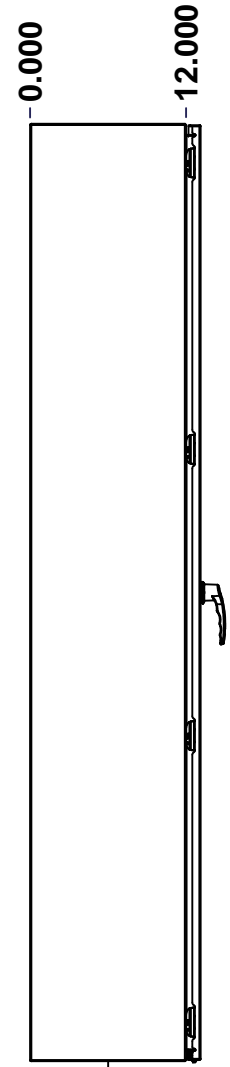

LEFT

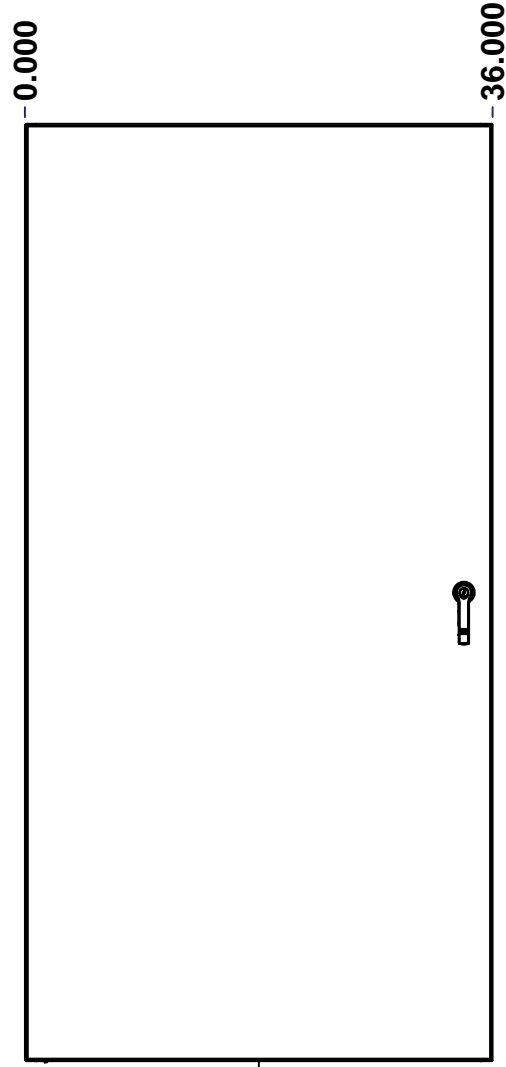

FRONT

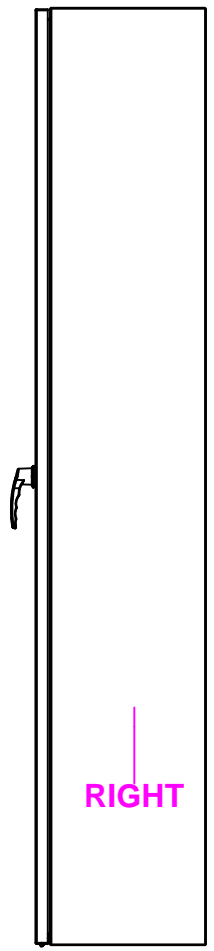

RIGHT

-35.446

-0.000

No.	Revisions	Date	By/Par

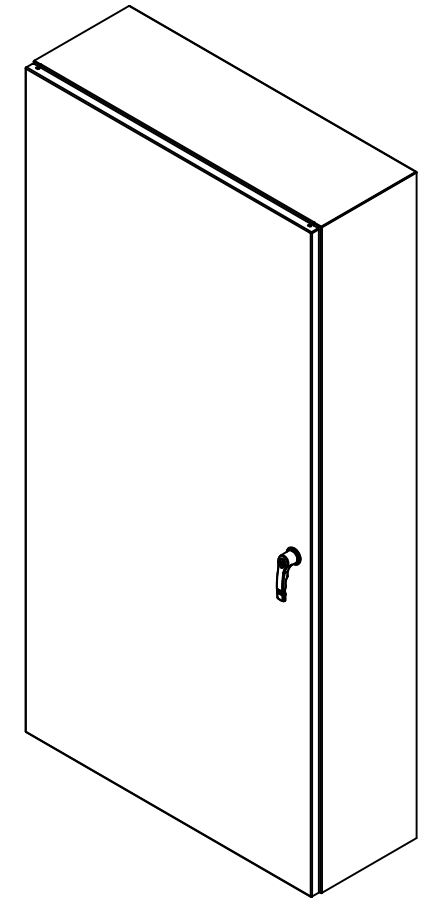

Isometric View



Tél: (450) 979-4373
 Fax: (450) 979-4626
www.exmweb.com

Flatness
 Aplatissement
 Max 3.0mm
 Projection

Customer Client
 Drawn By Dessiné Par BoxCad: Annie
 Date 23/03/2015

Material Matière Aluminum 5052-H32 (1.7mm)

Color Couleur Asa-61 Grey
 Finish Fini Smooth

Description 5412EALBU 72" x 36" x 12" Assembly
 Detail Rev.

Part Number Numéro Pièce 5412EALBU723612
 Rev. 0

SEE BILL OF MATERIAL ON LAST PAGE

1
2

This drawing is confidential and must not be reproduced or used without the consent of EXM

Ce dessin est confidentiel et ne doit pas être reproduit ou utilisé sans le consentement de EXM

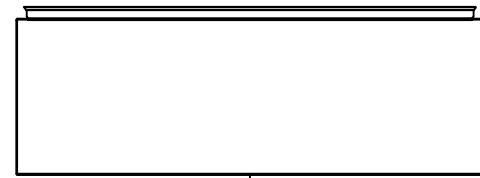

TOP

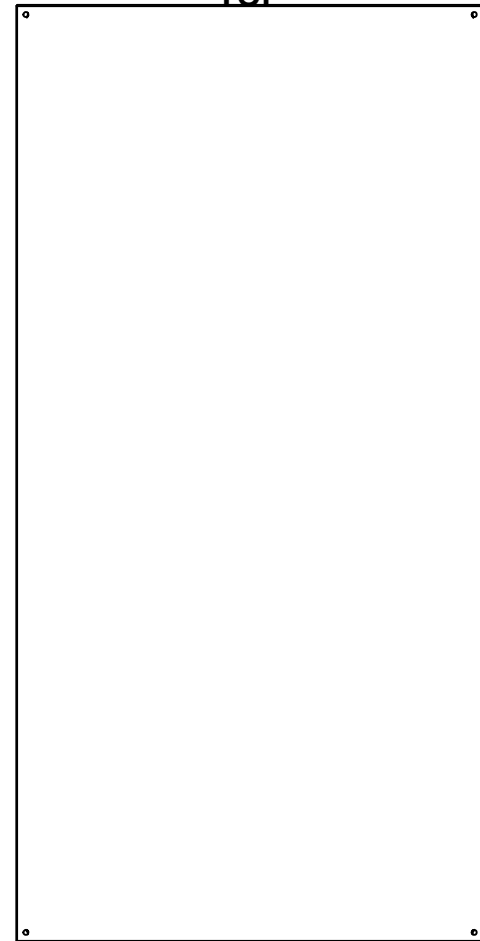

BACK

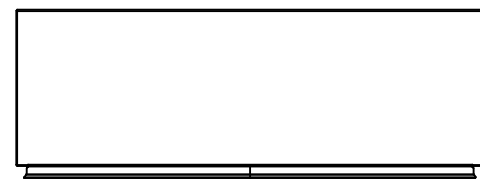

BOTTOM

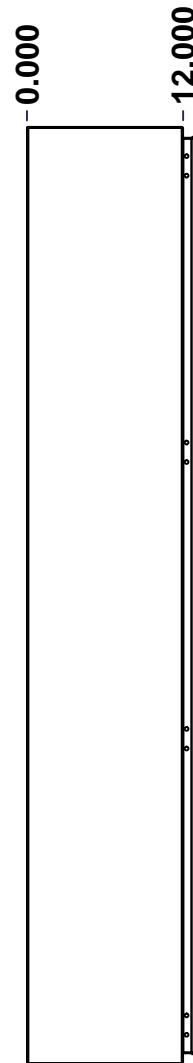

LEFT

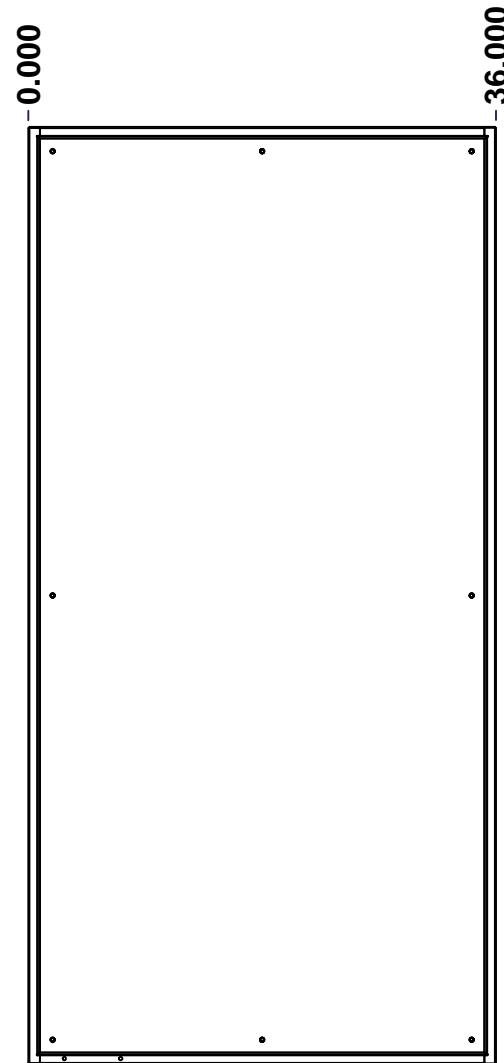

FRONT

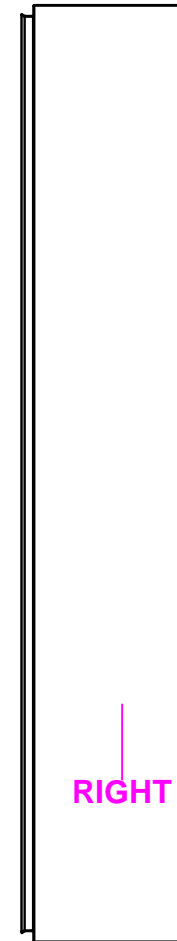

RIGHT

-35.446

⊕0.000

No.	Revisions	Date	By/Par

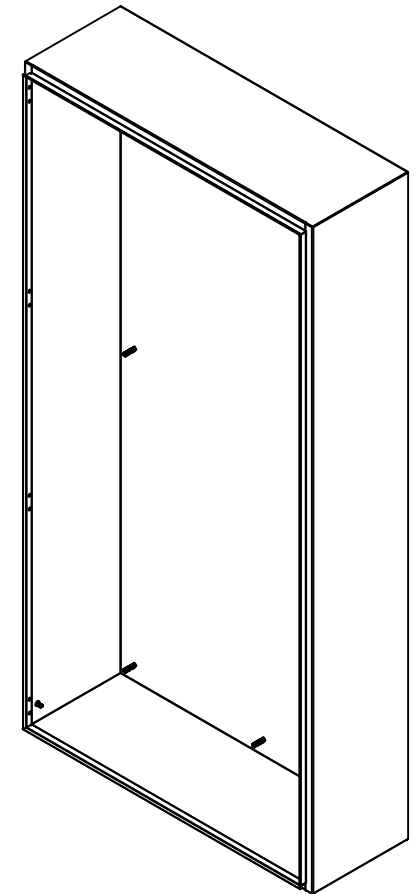

Isometric View



Tél: (450) 979-4373
 Fax: (450) 979-4626
www.exmweb.com

Flatness
Aplatissement

Max 3.0mm

Projection

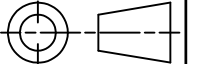

Customer Client	Date
Drawn By / Dessiné Par: BoxCad: Annie	Date: 23/03/2015

Material / Matière: Aluminum 5052-H32 (1.7mm)

Color / Couleur: Asa-61 Grey	Finish / Fini: Smooth
------------------------------	-----------------------

Description: 5412EALBU 72" x 36" x 12" Body

Part Number / Numéro Pièce: 5412EALBU723612B	Rev. 0	1 / 7
--	--------	-------

SEE BILL OF MATERIAL ON LAST PAGE

This drawing is confidential and must not be reproduced or used without the consent of EXM

Ce dessin est confidentiel et ne doit pas être reproduit ou utilisé sans le consentement de EXM

STANDARD FEATURES ARE NOT LISTED IN THIS HOLE TABLE			
HOLE TABLE - LEFT VIEW (CUSTOM FEATURE ONLY)			
CUT-OUT	XDIM	YDIM	DESCRIPTION
1	10.500	2.000	GND STUD M6 x 16mm (Inside)

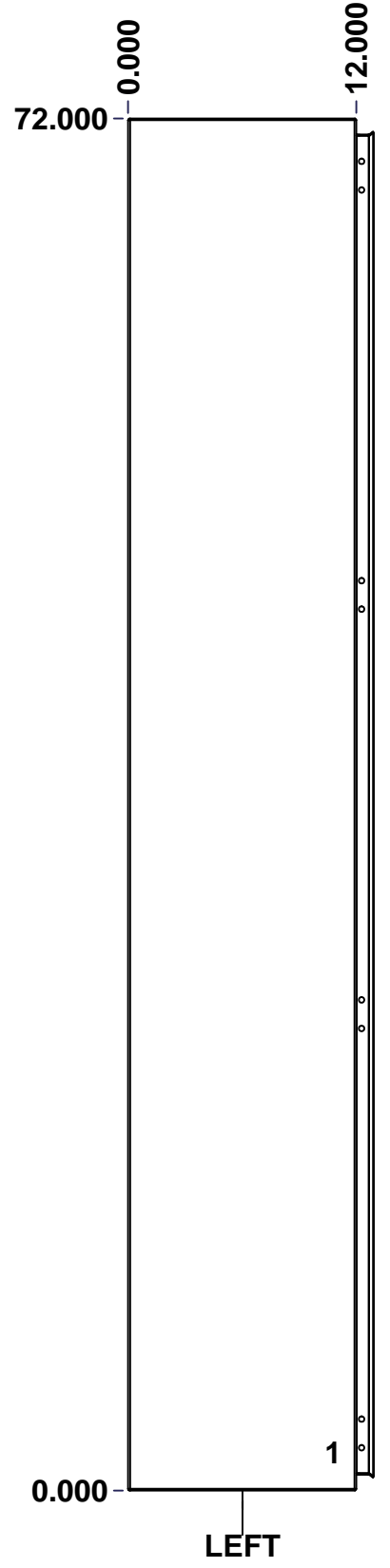

	Description	Status	
	5412EALBU 72" x 36" x 12" Body		
	Part Number Numéro Pièce	Rev.	
	5412EALBU723612B	0	5 / 7

This drawing is confidential and must not be reproduced or used without the consent of EXM

Ce dessin est confidentiel et ne doit pas être reproduit ou utilisé sans le consentement de EXM

STANDARD FEATURES ARE NOT LISTED IN THIS HOLE TABLE

HOLE TABLE - BACK VIEW (CUSTOM FEATURE ONLY)

CUT-OUT	XDIM	YDIM	DESCRIPTION
1	1.807	1.875	IP STUD M8 x 35mm (Inside)
2	1.807	70.125	IP STUD M8 x 35mm (Inside)
3	34.057	70.125	IP STUD M8 x 35mm (Inside)
4	34.057	1.875	IP STUD M8 x 35mm (Inside)
5	1.807	36.000	IP STUD M8 x 35mm (Inside)
6	34.057	36.000	IP STUD M8 x 35mm (Inside)
7	17.932	1.875	IP STUD M8 x 35mm (Inside)
8	17.932	70.125	IP STUD M8 x 35mm (Inside)

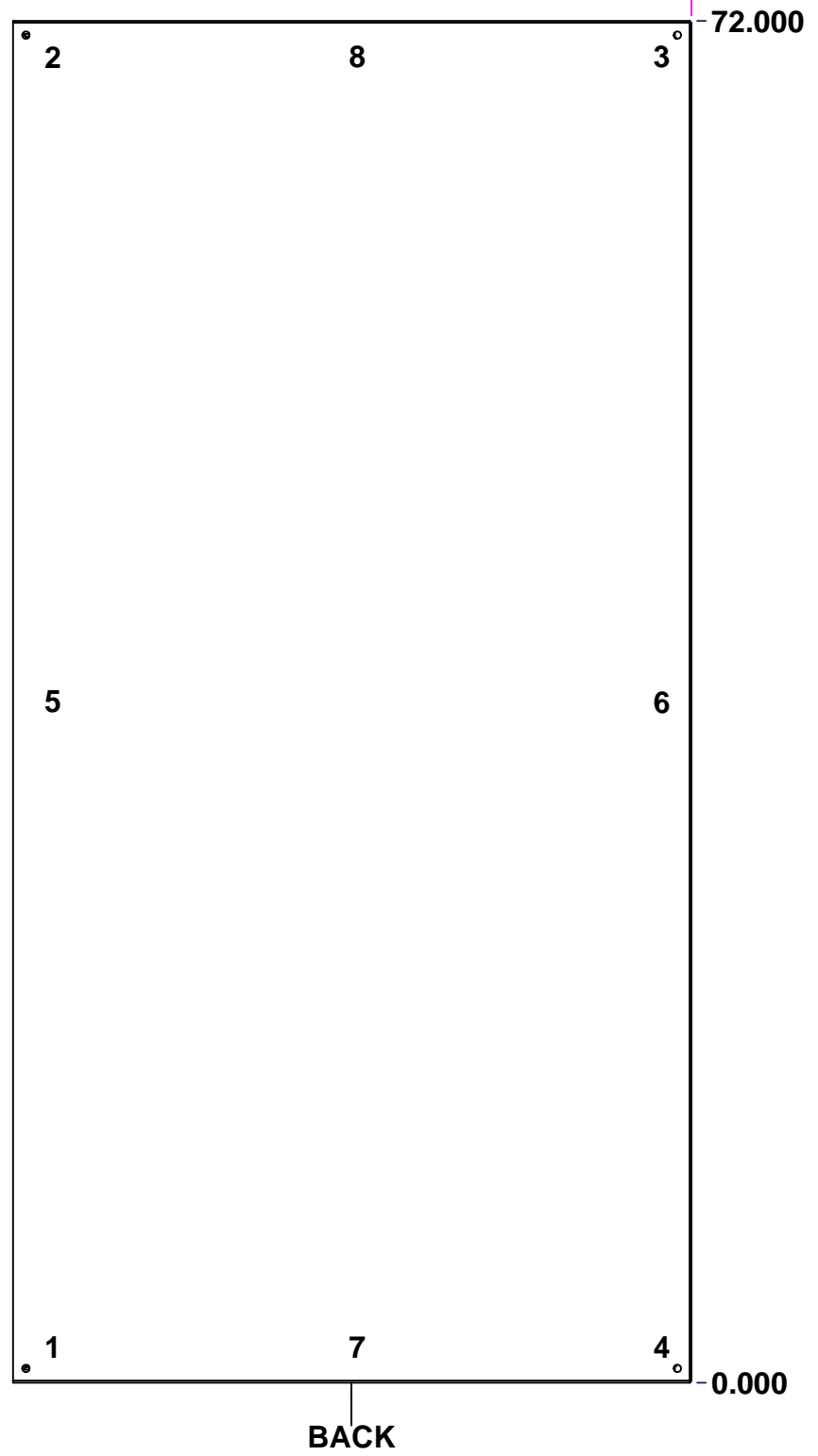



	Description		Status
	5412EALBU 72" x 36" x 12" Body		
	Part Number Numéro Pièce		Rev.
	5412EALBU723612B		6 0

This drawing is confidential and must not be reproduced or used without the consent of EXM

Ce dessin est confidentiel et ne doit pas être reproduit ou utilisé sans le consentement de EXM

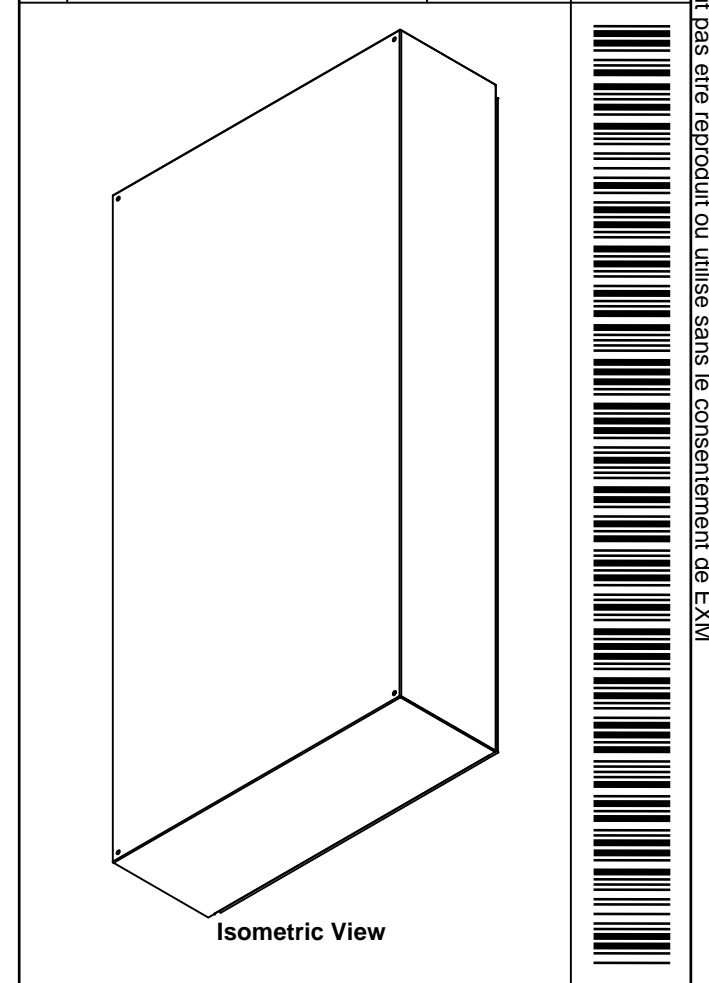
No.	Revisions	Date	By/Par

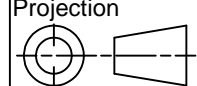

 Tél: (450) 979-4373 Fax: (450) 979-4626 www.exmweb.com		Flatness Aplatissement Max 3.0mm Projection 
Customer Client	Date	
Drawn By Dessiné Par	BoxCad: Annie	Date 23/03/2015
Material Matière	Aluminum 5052-H32 (1.7mm)	
Color Couleur	Asa-61 Grey	Finish Fini Smooth
Description		Detail Rev.
5412EALBU 72" x 36" x 12" Body		
Part Number Numéro Pièce	Rev.	7
5412EALBU723612B	0	7

Qty	Part Number	Rev	Description
1	STK-P-02400S	0	Powder Paint (Asa-61 Grey / Smooth)
8	STK-Q-16010	0	Stud M8 x 35mm Aluminum
1	STK-Q-16090	0	M6 x 16mm Aluminum Ground Stud
1	5412EALBU723612RS-P	0	5412EALBU 72" x 36" x 12" Body Part
1	5412EALBU723612B-P	0	5412EALBU 72" x 36" x 12" Body Part
Parts List			

This drawing is confidential and must not be reproduced or used without the consent of EXM

Ce dessin est confidentiel et ne doit pas être reproduit ou utilisé sans le consentement de EXM

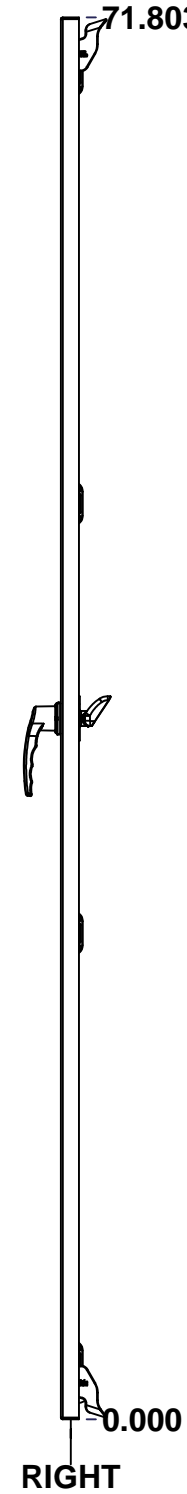
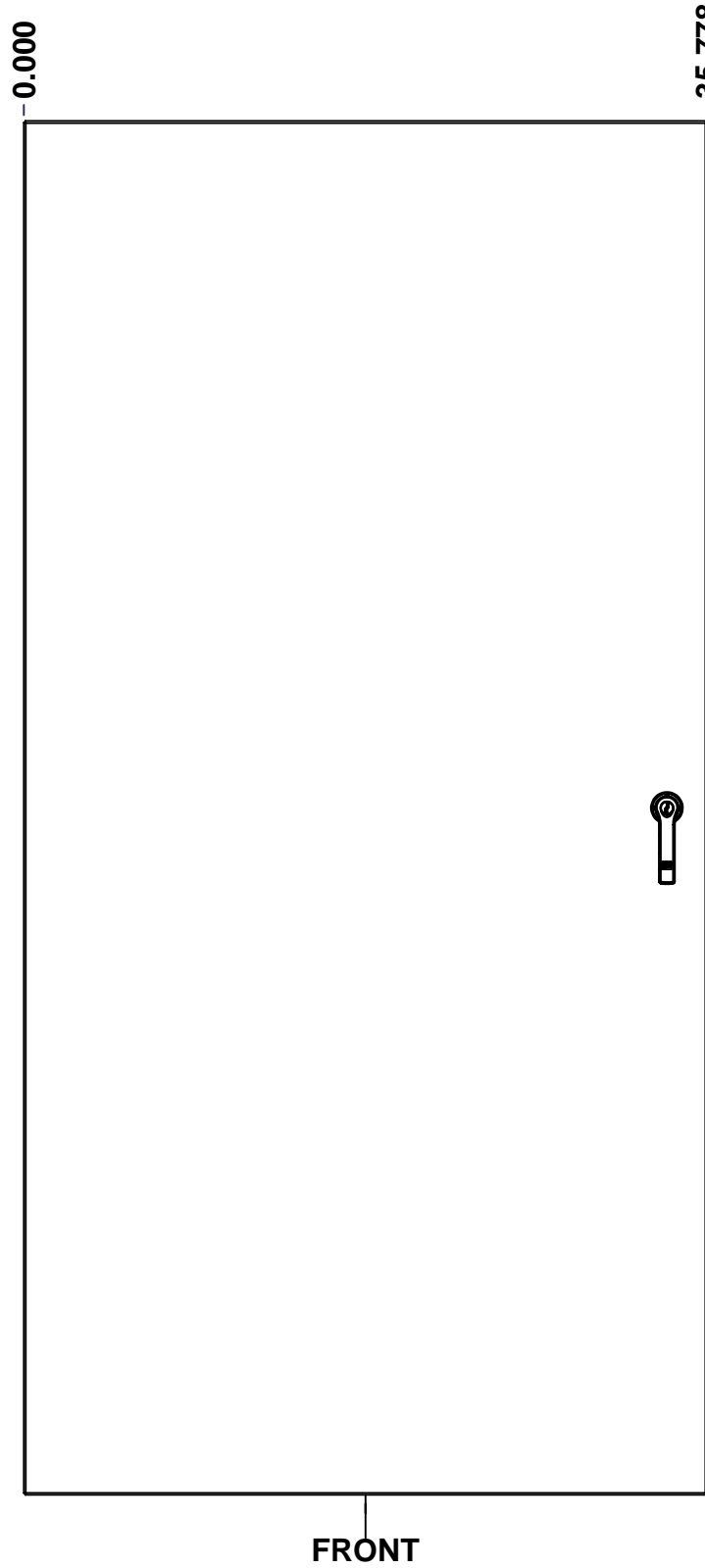
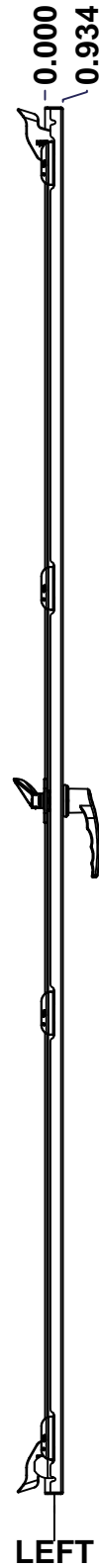
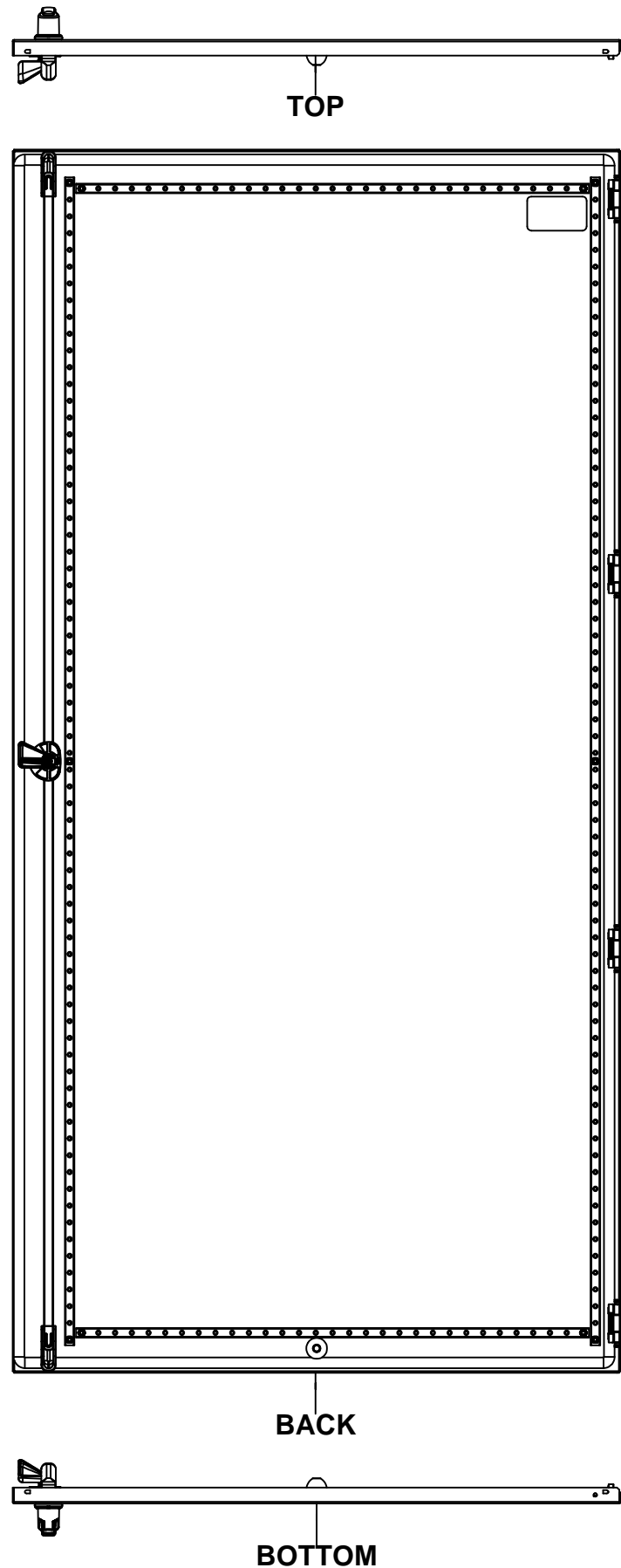

No.	Revisions	Date	By/Par

Isometric View

Tél: (450) 979-4373 Fax: (450) 979-4626 www.exmweb.com		Flatness Aplatissement	
		Max 3.0mm	
Customer Client		Projection	
Date			
Drawn By Dessiné Par BoxCad: Annie		Date 23/03/2015	
Material Matière Aluminum 5052-H32 (1.7mm)		Date	
Color Couleur Asa-61 Grey		Finish Fini Smooth	
Description 5412EALBU 72" x 36" Cover		Detail Rev.	
Part Number Numéro Pièce 5412EALBU723612C		Rev. 0	1 3

SEE BILL OF MATERIAL ON LAST PAGE

This drawing is confidential and must not be reproduced or used without the consent of EXM

Ce dessin est confidentiel et ne doit pas être reproduit ou utilisé sans le consentement de EXM

STANDARD FEATURES ARE NOT LISTED IN THIS HOLE TABLE

HOLE TABLE - FRONT VIEW (CUSTOM FEATURE ONLY)

CUT-OUT	XDIM	YDIM	DESCRIPTION
1	1.486	1.945	STUD M6 x 18mm (Inside)
2	1.486	69.858	STUD M6 x 18mm (Inside)
3	32.423	69.858	STUD M6 x 18mm (Inside)
4	32.423	1.945	STUD M6 x 18mm (Inside)
5	1.486	35.902	STUD M6 x 18mm (Inside)
6	32.423	35.902	STUD M6 x 18mm (Inside)
7	2.191	2.350	STUD M6 x 18mm (Inside)
8	2.191	69.524	STUD M6 x 18mm (Inside)
9	31.718	69.524	STUD M6 x 18mm (Inside)
10	31.718	2.350	STUD M6 x 18mm (Inside)
11	33.803	66.896	CLOSING BAR STUD (Inside)
12	33.803	4.907	CLOSING BAR STUD (Inside)
13	17.959	1.435	STUD M6 x 18mm (Inside)

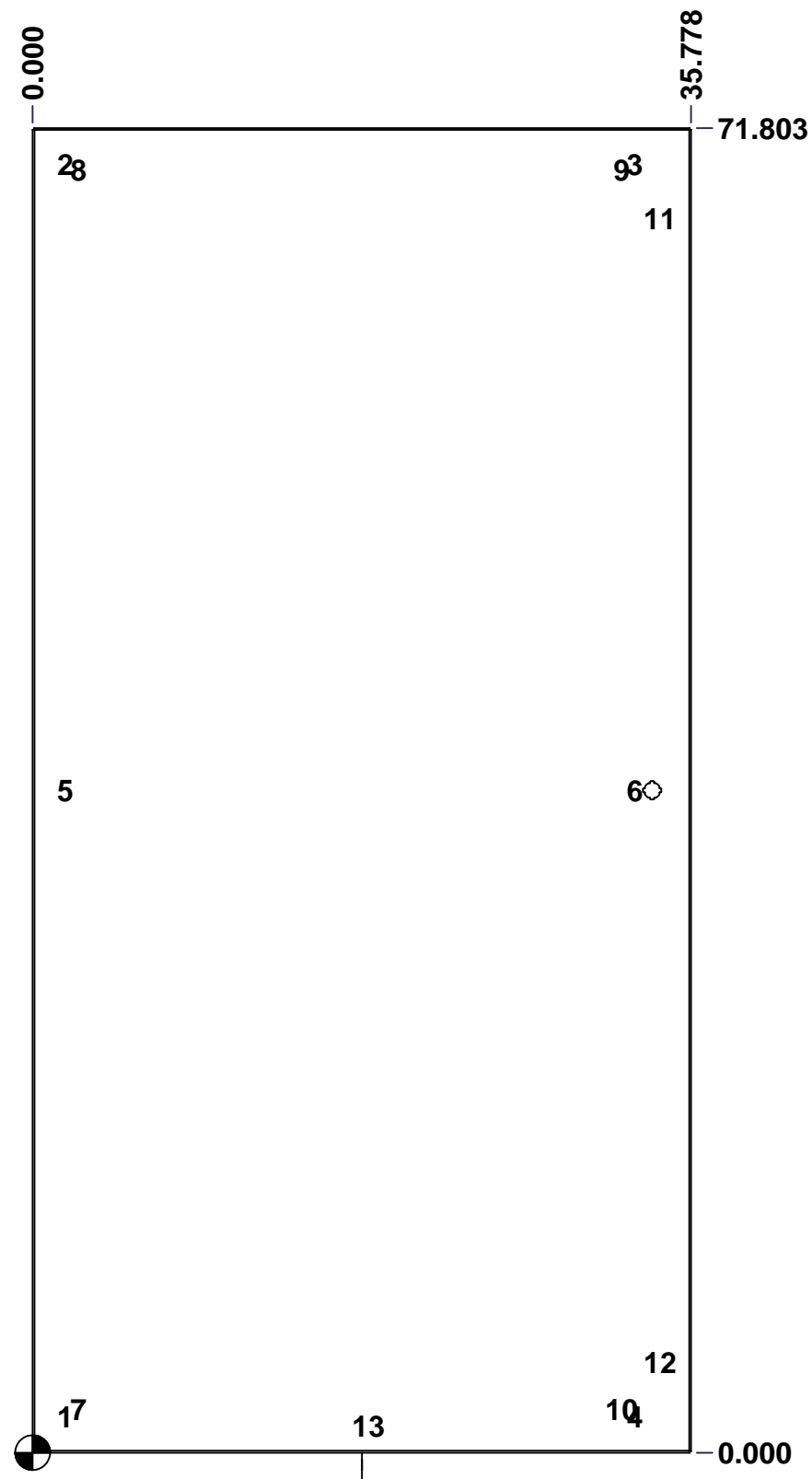

	Description	Status
	5412EALBU 72" x 36" Cover	(NULL)
	Part Number Numéro Pièce	Rev.
	5412EALBU723612C	0
		2
		3

This drawing is confidential and must not be reproduced or used without the consent of EXM

Ce dessin est confidentiel et ne doit pas être reproduit ou utilisé sans le consentement de EXM

No.	Revisions	Date	By/Par

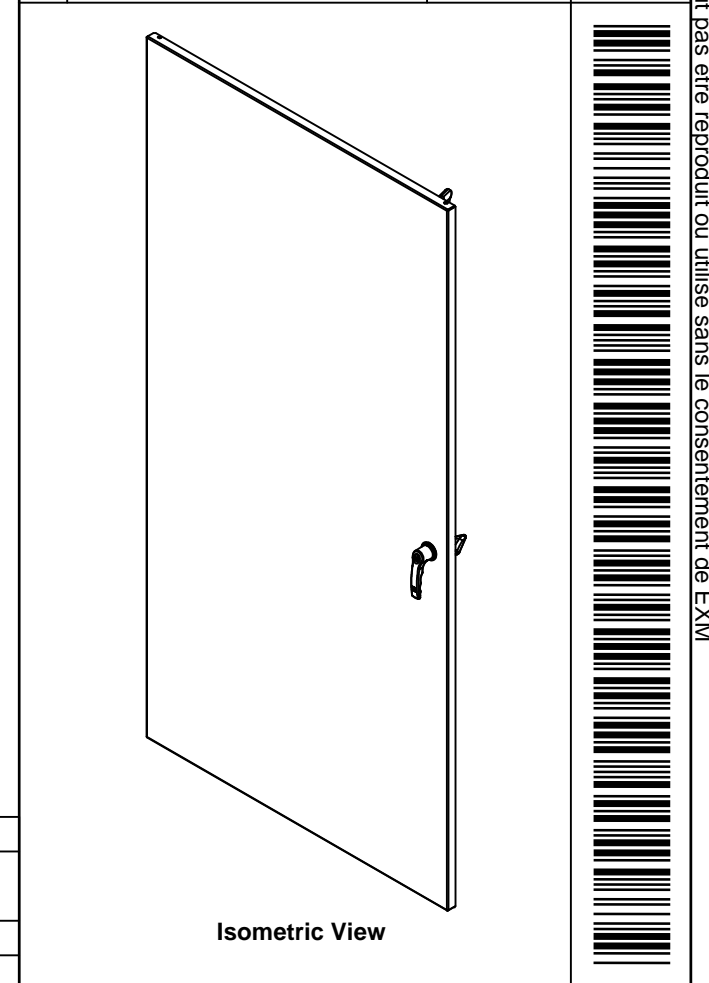

1	STK-P-02400S	0	Powder Paint (Asa-61 Grey / Smooth)
1	STK-S-00100	0.1.1	3.5" x 2" Silver Milar Flexcon Sticker
1	STK-Q-46515	3	5412 ES Door Support with Brass Insert
2	STK-Q-90042	0	5412 ES - Cabinet Closing Bar End (Small)
2	STK-Q-45655-72	0	5412 ES - Closing Bar
1	STK-K-50536	4	Handle Gear Clockwise Assy (Grip 32mm)
2	STK-Q-16405	2	Guide Stud - Small (No Paint Cap Required)
11	STK-Q-16060	0	Stud M6 x 18mm Aluminum
1	885 ESL2A	0	5412 ES Key Lock L-Handle (3 Pts)
1			
1			
4	STK-Q-33106	0	5412 ESSBU Buttable Hinge (Cover Part)
2	STK-Q-46025-36-3	0.1.1	5412 ES Horizontal Door Stiffener 36" (3 Pts)
2	STK-Q-46020-72	5	5412 ES Vertical Door Stiffener 72"
1			
1			
1	5412EALBU723612G	0	5412EALBU 72" x 36" Cover Gasket
1	5412EALBU723612C-P	0	5412EALBU 72" x 36" Cover Part
10	STK-Q-07220	1	M6 Nylon Insert Lock Nut
Qty	Part Name	Rev	Description

Tél: (450) 979-4373 Fax: (450) 979-4626 www.exmweb.com	Flatness Aplatissement
	Max 3.0mm
Projection	
Customer Client	Date
Drawn By Dessiné Par	Date 23/03/2015
Material Matière	Aluminum 5052-H32 (1.7mm)
Color Couleur	Asa-61 Grey
Finish Fini	Smooth
Description	Detail Rev.
5412EALBU 72" x 36" Cover	
Part Number Numéro Pièce	Rev. 3
5412EALBU723612C	0

Parts List

This drawing is confidential and must not be reproduced or used without the consent of EXM

Ce dessin est confidentiel et ne doit pas être reproduit ou utilisé sans le consentement de EXM

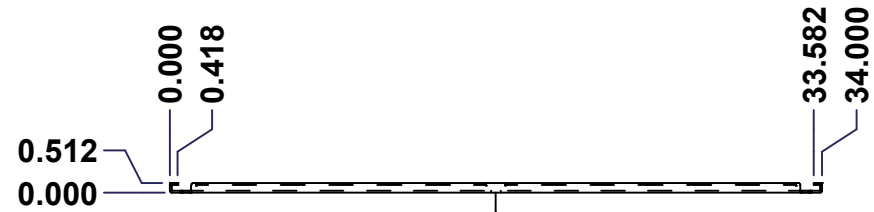

TOP

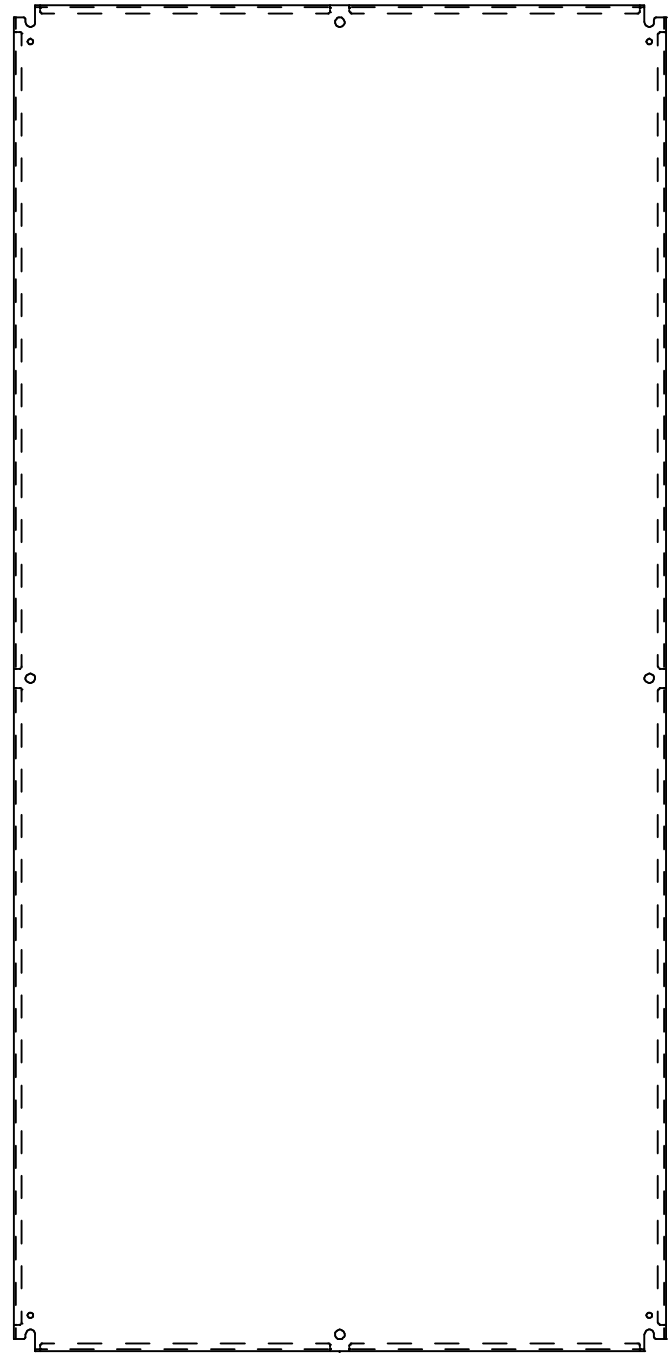

FRONT

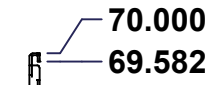

RIGHT

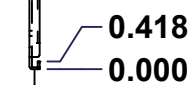

No.	Revisions	Date	By/Par

Isometric View

Qty	Part Number	Rev	Description	Material	Color	Finish
1	STK-P-02401S	0	Powder Paint (White / Smooth)	Polyester-Epoxy Hybrid	White RAL9003	Smooth
1	881 SP7236-P	0	881 SP - Inner Panel Part	12 Ga H.R.P. & O.	White	Smooth

Parts List

Tél: (450) 979-4373 Fax: (450) 979-4626 www.exmweb.com		Flatness Aplatissement Max 3.0mm Projection
Customer Client	Date	Date
Drawn By Dessiné Par	BoxCad	1/23/2007
Material Matière	See Part List	
Color Couleur	See Part List	Finish Fini
Description		Detail Rev.
881 SP - Inner Panel		
Part Number Numéro Pièce	Rev.	1
881 SP7236	0	2

This drawing is confidential and must not be reproduced or used without the consent of EXM

Ce dessin est confidentiel et ne doit pas être reproduit ou utilisé sans le consentement de EXM

Table 1			FRONT VIEW
CUT-OUT	XDIM	YDIM	DESCRIPTION
1	17.000	0.875	MTG STUD HOLE (RND Ø0.500)
2	0.875	35.000	MTG STUD HOLE (RND Ø0.500)
3	33.125	35.000	MTG STUD HOLE (RND Ø0.500)
4	17.000	69.125	MTG STUD HOLE (RND Ø0.500)
5	0.875	1.875	GROUND HOLE (RND Ø0.290)
6	33.125	1.875	GROUND HOLE (RND Ø0.290)
7	0.875	68.125	GROUND HOLE (RND Ø0.290)
8	33.125	68.125	GROUND HOLE (RND Ø0.290)

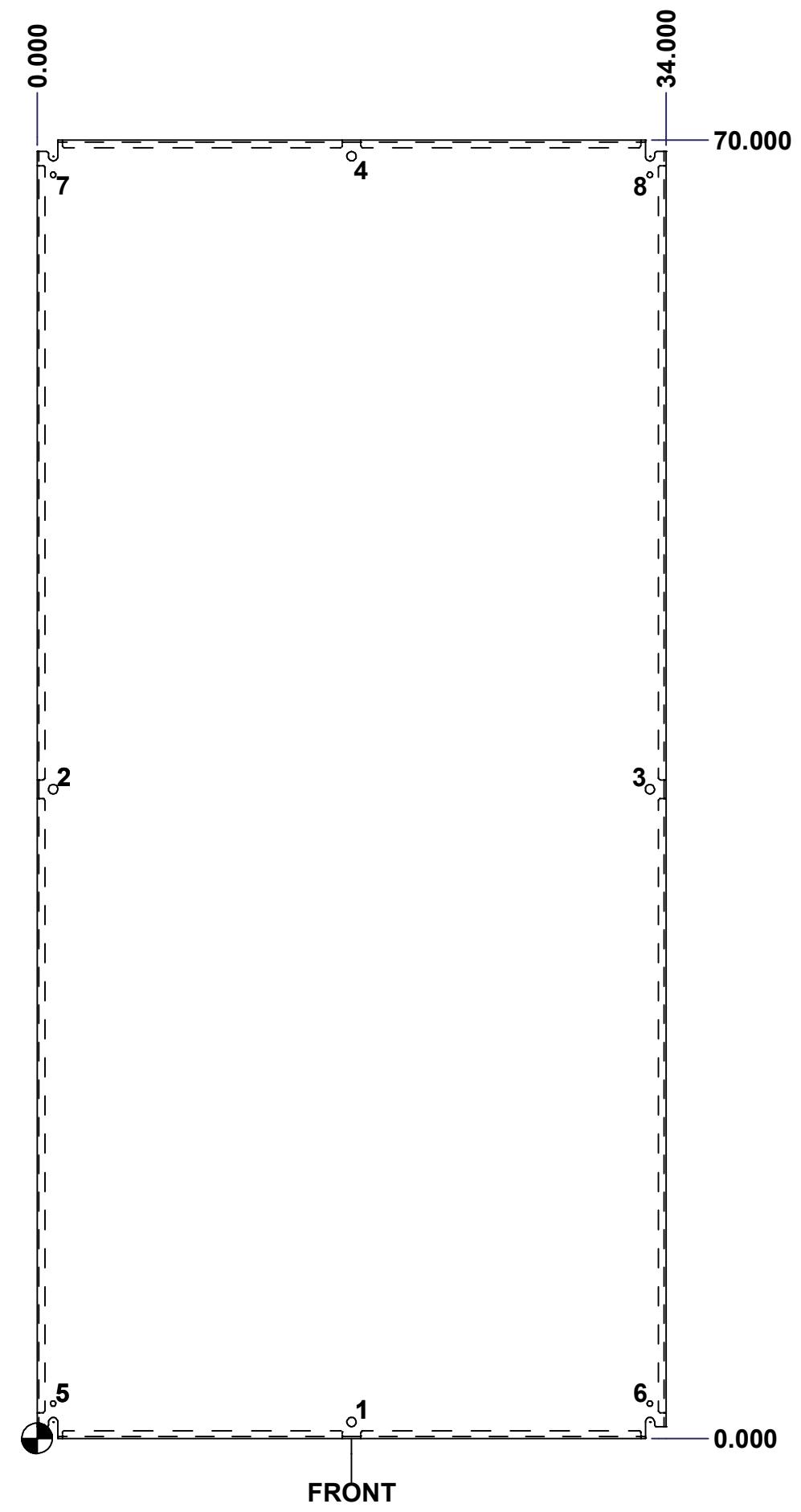

All knockouts are actual size / Les disques défonçables sont grandeur réel

No.	Revisions	Date	By/Par

Isometric View

		Tél: (450) 979-4373 Fax: (450) 979-4626 www.exmweb.com		Flatness Aplatissement Max 3.0mm
Customer Client		Date		Projection
Drawn By Dessiné Par BoxCad		Date 1/23/2007		Material Matière See Part List
Color Couleur See Part List		Finish Fini See Part List		Description 881 SP - Inner Panel
Part Number Numéro Pièce 881 SP7236		Rev. 0	2 2	Detail Rev.