

This drawing is confidential and must not be reproduced or used without the consent of EXM

Ce dessin est confidentiel et ne doit pas être reproduit ou utilisé sans le consentement de EXM

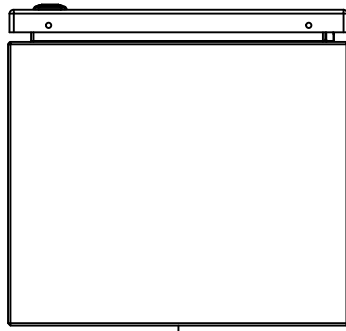

TOP

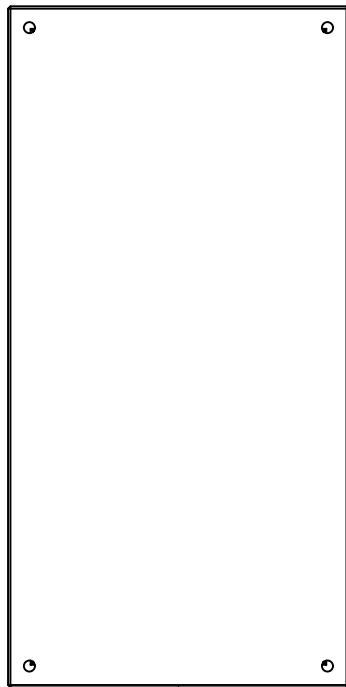

BACK

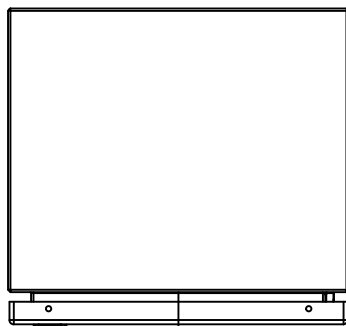

BOTTOM

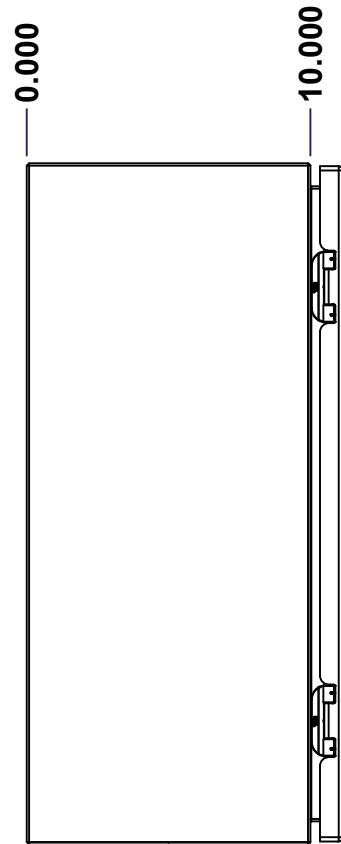

LEFT

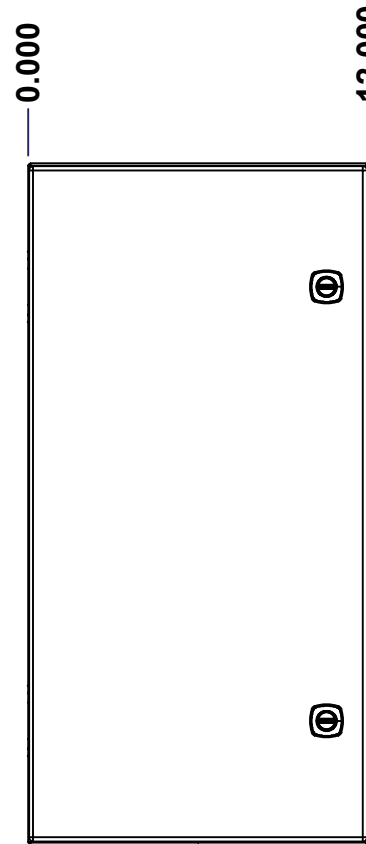

FRONT

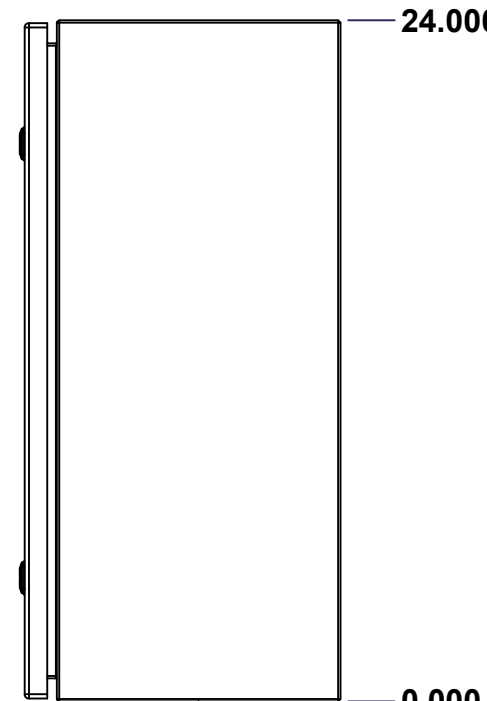

RIGHT

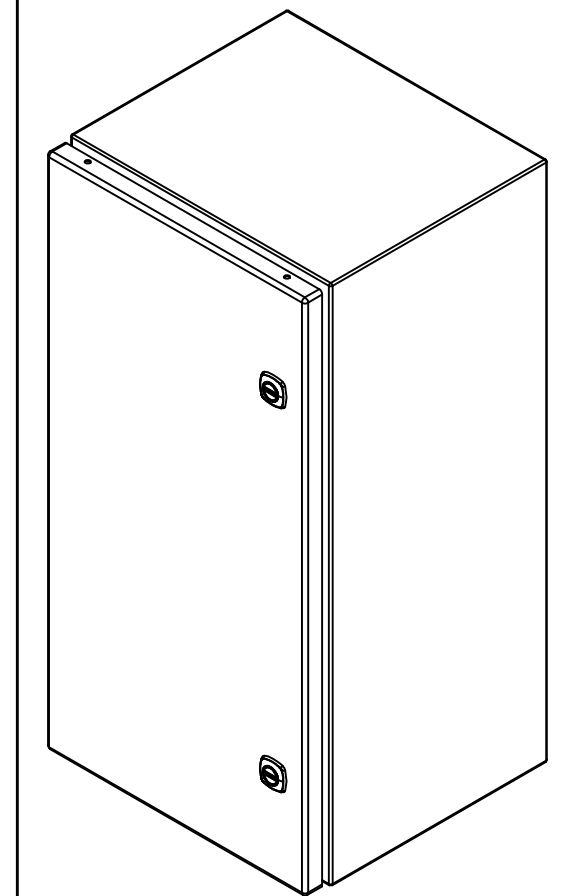

Isometric View

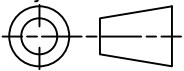

| No. | Revisions | Date | By/Par |
|-----|-----------|------|--------|
|     |           |      |        |
|     |           |      |        |
|     |           |      |        |
|     |           |      |        |
|     |           |      |        |

|  |   |   |
|--|---|---|
|  Tél: (450) 979-4373<br>Fax: (450) 979-4626<br><a href="http://www.exmweb.com">www.exmweb.com</a> |   | Flatness<br>Aplatissement<br>Max 3.0mm<br>Projection<br> |
| Customer Client  | Date                                      |   |
| Drawn By<br>Dessiné Par  | BoxCad: BoxCad                            | Date 06-Apr-17  |
| Material<br>Matière  | 16 Ga Cold Rolled A1008 CS Type B (1.4mm) |   |
| Color<br>Couleur   | Light Grey RAL7035                        | Finish<br>Fini Textured   |
| Description  | Detail Rev.                               |   |
| 5412ES 24" x 12" x 10" Assembly  |   |   |
| Part Number<br>Numéro Pièce  | Rev.                                      | 1   |
| <b>5412ESB241210</b>   | <b>0</b>                                  | 9   |

SEE BILL OF MATERIAL ON LAST PAGE

This drawing is confidential and must not be reproduced or used without the consent of EXM

Ce dessin est confidentiel et ne doit pas être reproduit ou utilisé sans le consentement de EXM

| NOTE |  |
|------|--|
| ITEM | DESCRIPTION                                |
| 1    | NEMA 4, 12 Enclosure (IP66)                |
| 2    | C/W Standard ground studs on box and cover |
| 3    | C/W Standard door stiffener                |
| 4    | C/W Standard inner panel (Included)        |
| 5    | C/W Standard inner panel mounting studs    |

| No. | Revisions | Date | By/Par |
|-----|-----------|------|--------|
|     |           |      |        |
|     |           |      |        |
|     |           |      |        |
|     |           |      |        |
|     |           |      |        |
|     |           |      |        |

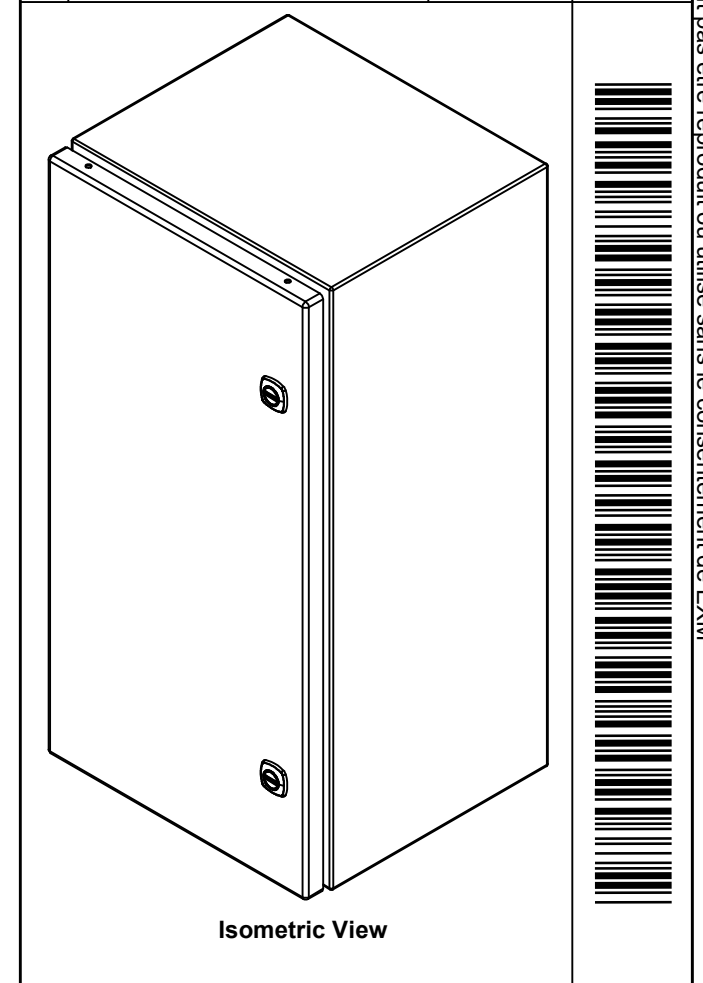

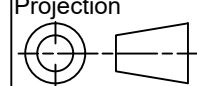
|  |   |
|--|---|
|  Tél: (450) 979-4373<br>Fax: (450) 979-4626<br><a href="http://www.exmweb.com">www.exmweb.com</a> | Flatness<br>Aplatissement   |
|  | Max 3.0mm   |
| Projection   |  |
| Customer Client  | Date  |
| Drawn By<br>Dessiné Par BoxCad: BoxCad   | Date 06-Apr-17  |
| Material<br>Matière 16 Ga Cold Rolled A1008 CS Type B (1.4mm)  |   |

| PACKING               |     |  |
|-----------------------|-----|--|
| ITEM                  | QTY | DESCRIPTION                                |
| Cardboard sleeve      | 2   | Top and Bottom                             |
| Cardboard strip       | 2   | Between back of enclosure and inner panel  |
| Plastic bag           | 1   | To protect cover surface and inside gasket |
| Plastic strap - Black | 2   | To Squeeze the 2 cardboard sleeve together |
| Packaging label       | 1   | White label with product number            |

|            |                |     |  |
|------------|----------------|-----|--|
| 1          | 881 SP2412G    | 0   | 881 SP - Inner Panel                       |
| 2          | STK-K-01320    | 0   | 5412 ES Inner Panel Accessory Kit          |
| 1          | STK-K-01800    | 5   | 5412 ES Accessory Kit                      |
| 1          | 5412ESB241210C | 0   | 5412ES 24" x 12" Cover                     |
| 1          | 5412ESB241210B | 0   | 5412ES 24" x 12" x 10" Body                |
| 2          | STK-Q-04050-08 | 0   | M6 x 8mm Hexagon Socket Head Machine Screw |
| Qty        | Part Number    | Rev | Description                                |
| Parts List |                |     |  |

|   |                         |
|---|-------------------------|
| Color<br>Couleur Light Grey RAL7035                 | Finish<br>Fini Textured |
| Description<br>5412ES 24" x 12" x 10" Assembly      | Detail Rev.             |
| Part Number<br>Numéro Pièce<br><b>5412ESB241210</b> | Rev. 0                  |
|   | 2<br>9                  |

This drawing is confidential and must not be reproduced or used without the consent of EXM

Ce dessin est confidentiel et ne doit pas être reproduit ou utilisé sans le consentement de EXM

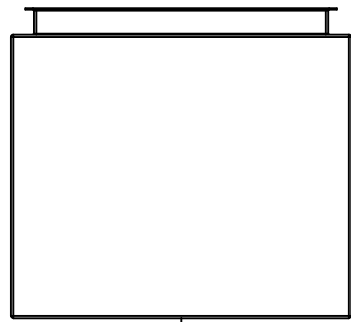

TOP

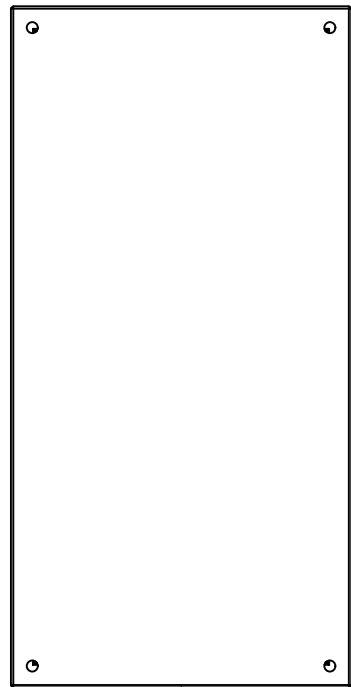

BACK

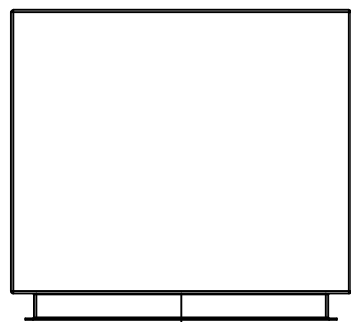

BOTTOM

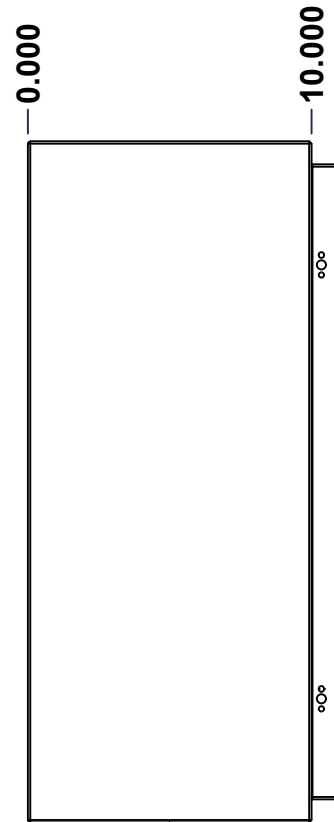

LEFT

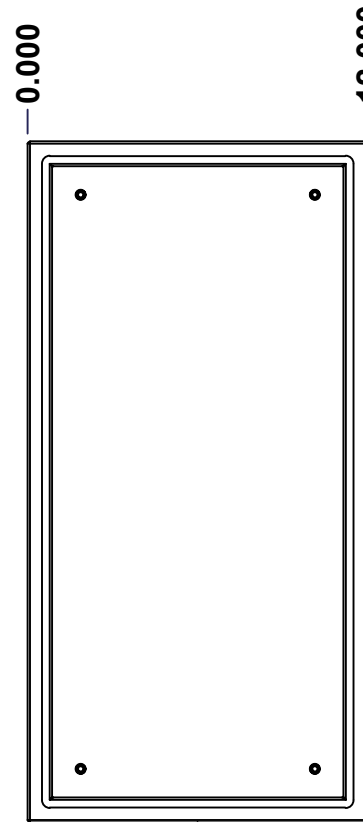

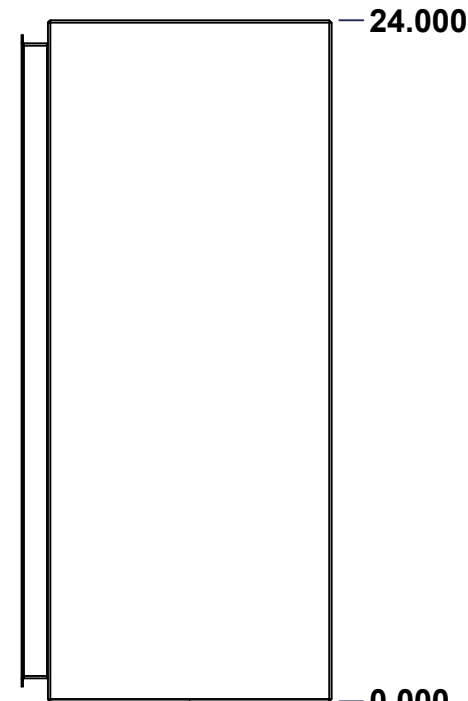

FRONT

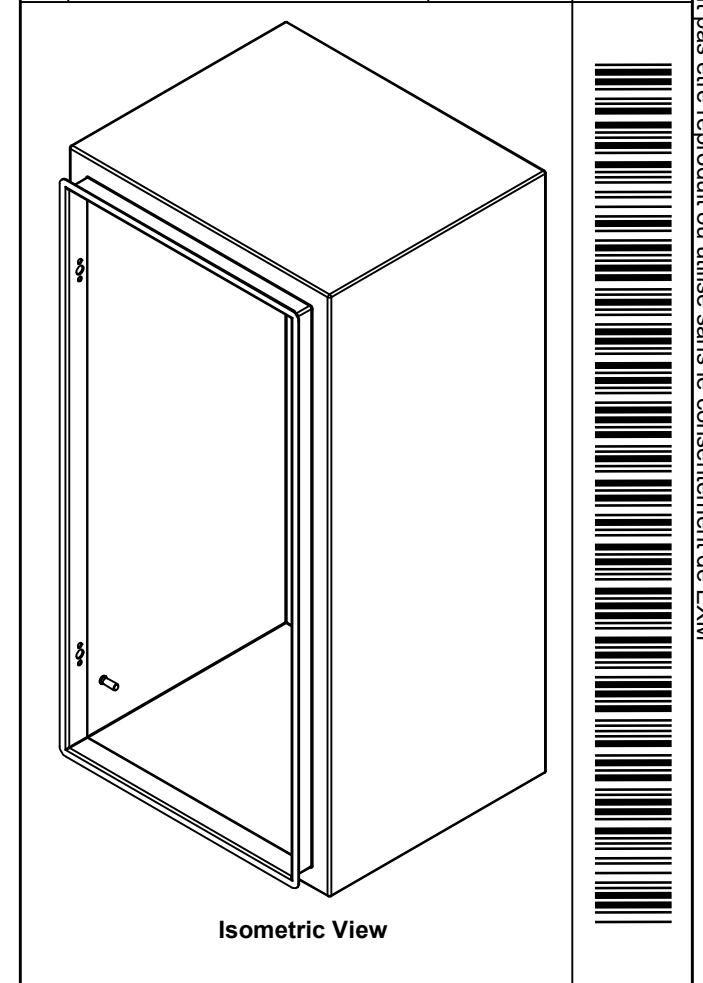

RIGHT

| No. | Revisions | Date | By/Par |
|-----|-----------|------|--------|
|     |           |      |        |
|     |           |      |        |
|     |           |      |        |
|     |           |      |        |
|     |           |      |        |

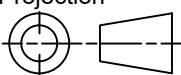

|  |   |   |
|--|---|---|
|  Tél: (450) 979-4373<br>Fax: (450) 979-4626<br><a href="http://www.exmweb.com">www.exmweb.com</a> |   | Flatness<br>Aplatissement<br>Max 3.0mm<br>Projection<br> |
| Customer<br>Client   | Date                                      |   |
| Drawn By<br>Dessiné Par  | BoxCad: BoxCad                            | Date 06-Apr-17  |
| Material<br>Matière  | 16 Ga Cold Rolled A1008 CS Type B (1.4mm) |   |
| Color<br>Couleur   | Light Grey RAL7035                        | Finish<br>Fini Textured   |
| Description  | Detail Rev.                               |   |
| 5412ES 24" x 12" x 10" Body  |   |   |
| Part Number<br>Numéro Pièce  | Rev.                                      | 3   |
| 5412ESB241210B   | 0   | 9   |

SEE BILL OF MATERIAL ON LAST PAGE

This drawing is confidential and must not be reproduced or used without the consent of EXM

Ce dessin est confidentiel et ne doit pas être reproduit ou utilisé sans le consentement de EXM

| <b>STANDARD FEATURES ARE NOT LISTED IN THIS HOLE TABLE</b> |       |       |                             |
|--|-------|-------|-----------------------------|
| <b>HOLE TABLE - LEFT VIEW (CUSTOM FEATURE ONLY)</b>        |       |       |                             |
| CUT-OUT  | XDIM  | YDIM  | DESCRIPTION                 |
| 1  | 8.500 | 2.000 | GND STUD M6 x 16mm (Inside) |

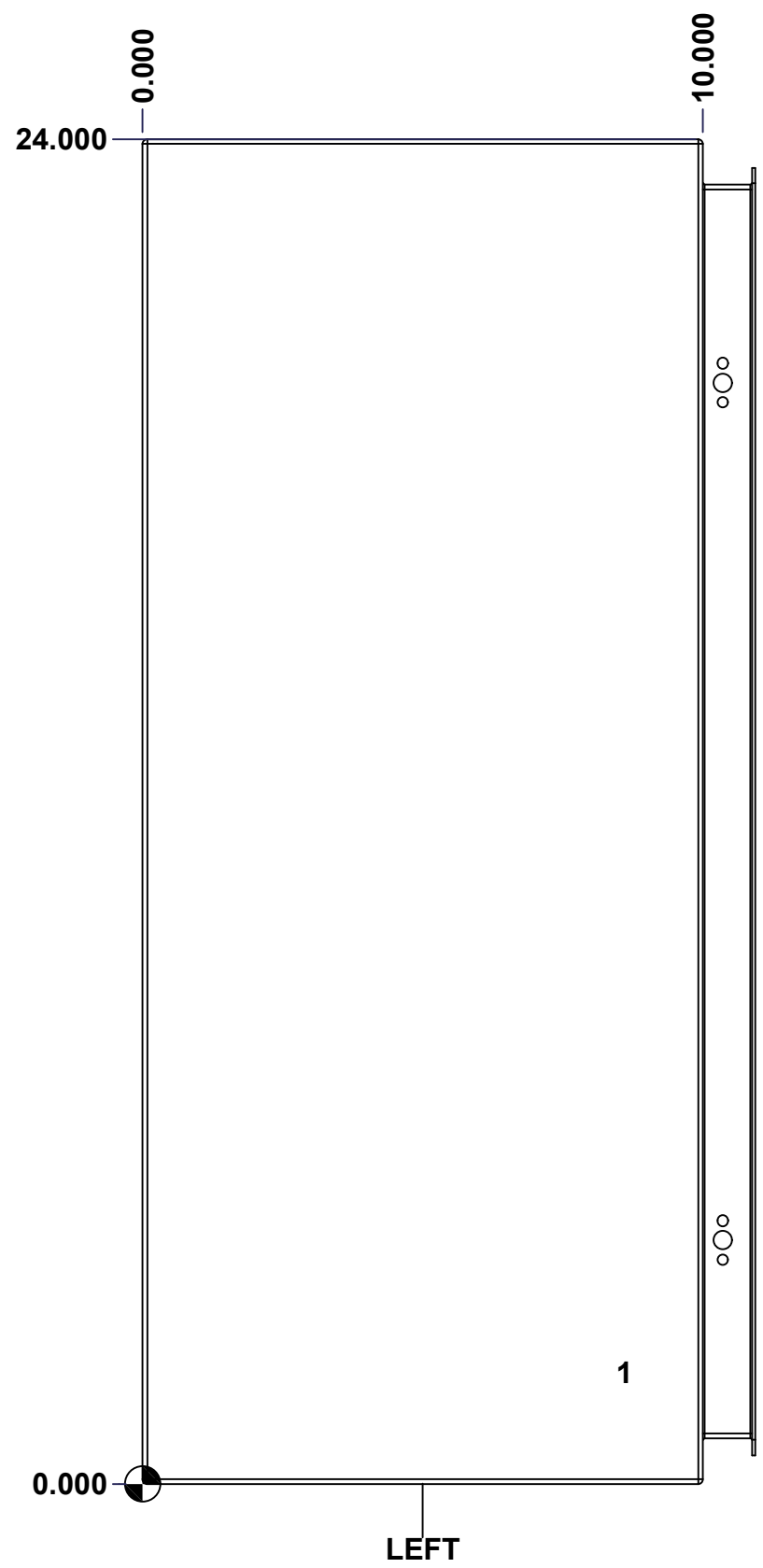

|  |                             |          |        |
|--|-----------------------------|----------|--------|
|  | Description                 | Status   |        |
|  | 5412ES 24" x 12" x 10" Body | (NULL)   |        |
|  | Part Number<br>Numéro Pièce | Rev.     |        |
|  | <b>5412ESB241210B</b>       | <b>0</b> | 4<br>9 |

This drawing is confidential and must not be reproduced or used without the consent of EXM

Ce dessin est confidentiel et ne doit pas être reproduit ou utilisé sans le consentement de EXM

**STANDARD FEATURES ARE NOT LISTED IN THIS HOLE TABLE**

**HOLE TABLE - BACK VIEW (CUSTOM FEATURE ONLY)**

| CUT-OUT | XDIM   | YDIM   | DESCRIPTION                |
|---------|--------|--------|----------------------------|
| 1       | 1.875  | 1.875  | IP STUD M8 x 35mm (Inside) |
| 2       | 1.875  | 22.125 | IP STUD M8 x 35mm (Inside) |
| 3       | 10.125 | 22.125 | IP STUD M8 x 35mm (Inside) |
| 4       | 10.125 | 1.875  | IP STUD M8 x 35mm (Inside) |
| -----   |        |        |                            |
| 5       | 11.250 | 0.750  | RND Ø0.390                 |
| 6       | 11.250 | 23.250 | RND Ø0.390                 |
| 7       | 0.750  | 23.250 | RND Ø0.390                 |
| 8       | 0.750  | 0.750  | RND Ø0.390                 |

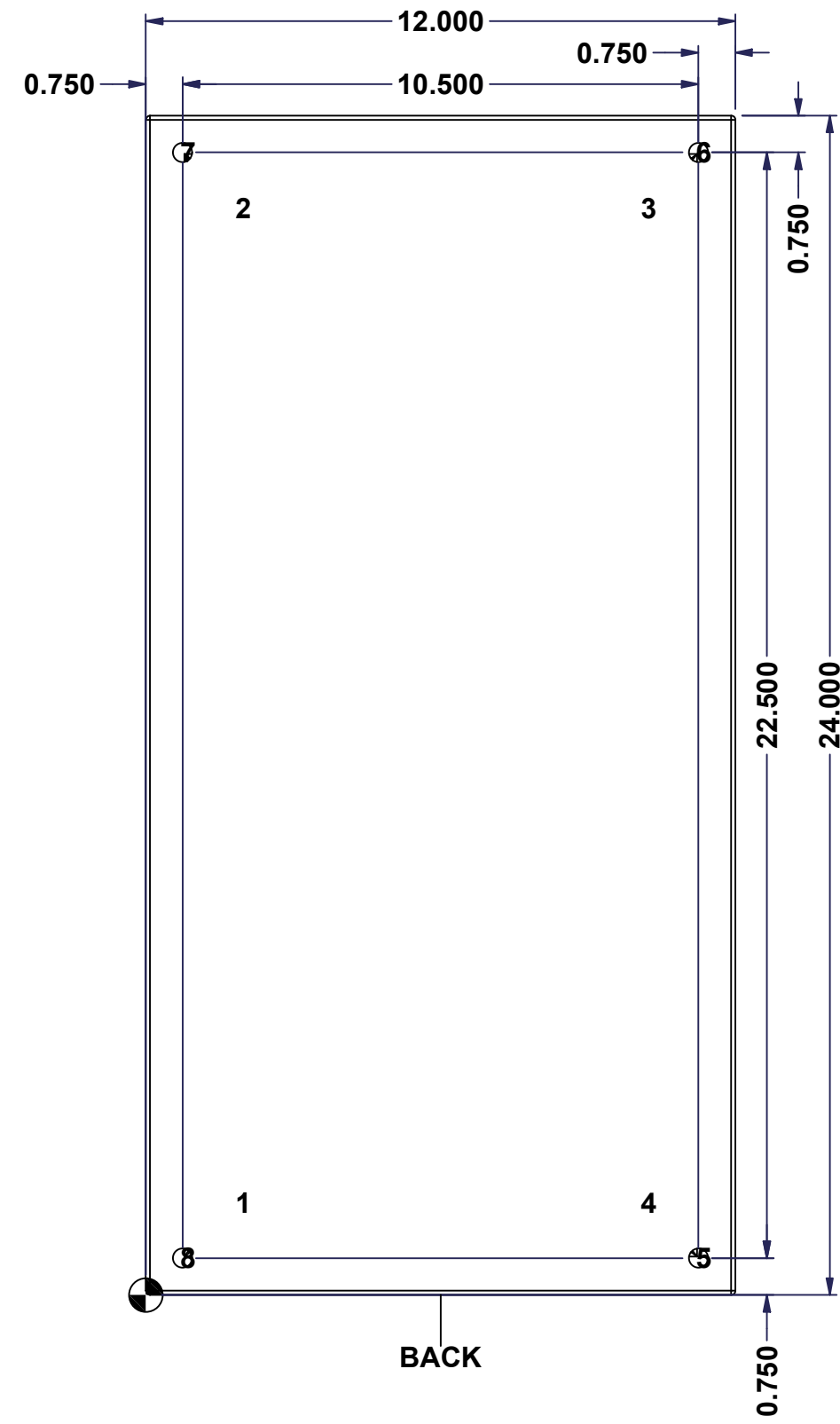

BACK

|  |                             |          |
|--|-----------------------------|----------|
|  | Description                 | Status   |
|  | 5412ES 24" x 12" x 10" Body | (NULL)   |
|  | Part Number                 | Rev.     |
|  | Numéro Pièce                | 5        |
|  | <b>5412ESB241210B</b>       | <b>0</b> |
|  |                             | 9        |

This drawing is confidential and must not be reproduced or used without the consent of EXM

Ce dessin est confidentiel et ne doit pas être reproduit ou utilisé sans le consentement de EXM

| No. | Revisions | Date | By/Par |
|-----|-----------|------|--------|
|     |           |      |        |
|     |           |      |        |
|     |           |      |        |
|     |           |      |        |
|     |           |      |        |

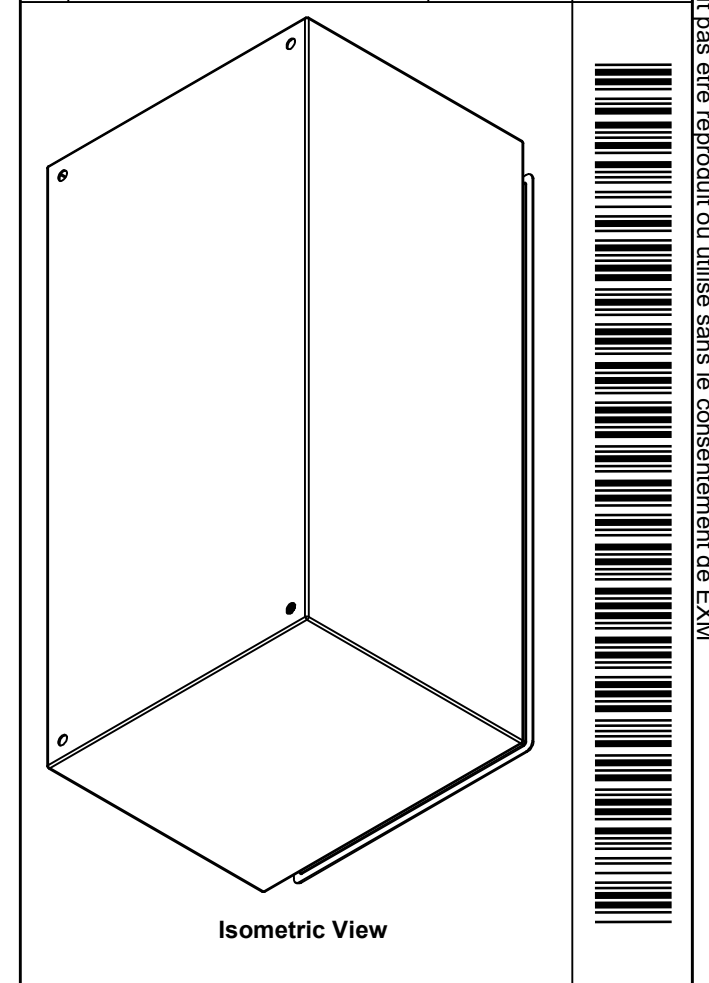

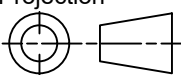
|  |   |   |
|--|---|---|
|  Tél: (450) 979-4373<br>Fax: (450) 979-4626<br><a href="http://www.exmweb.com">www.exmweb.com</a> |   | Flatness<br>Aplatissement<br>Max 3.0mm<br>Projection<br> |
| Customer Client  | Date                                      |   |
| Drawn By<br>Dessiné Par  | BoxCad: BoxCad                            | Date 06-Apr-17  |
| Material<br>Matière  | 16 Ga Cold Rolled A1008 CS Type B (1.4mm) |   |
| Color<br>Couleur   | Light Grey RAL7035                        | Finish<br>Fini Textured   |
| Description  |   | Detail Rev.   |
| 5412ES 24" x 12" x 10" Body  |   |   |
| Part Number<br>Numéro Pièce  | Rev.                                      | 6   |
| <b>5412ESB241210B</b>  | <b>0</b>                                  | 9   |

| Qty        | Part Number      | Rev | Description                                |
|------------|------------------|-----|--|
| 1          | STK-Q-16080      | 0   | Ground Stud M6 x 16mm Steel                |
| 1          | STK-P-03820R     | 0   | Powder Paint (Light Grey / Rough Textured) |
| 4          | STK-Q-16005      | 1   | Stud M8 x 35mm (No Paint Cap Required)     |
| 1          | 5412ESB241210B-P | 0   | 5412ES 24" x 12" x 10" Body Part           |
| Parts List |                  |     |  |

This drawing is confidential and must not be reproduced or used without the consent of EXM

Ce dessin est confidentiel et ne doit pas être reproduit ou utilisé sans le consentement de EXM

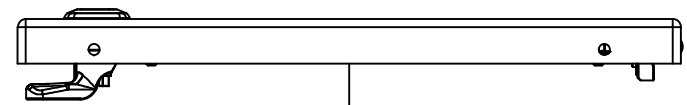

TOP

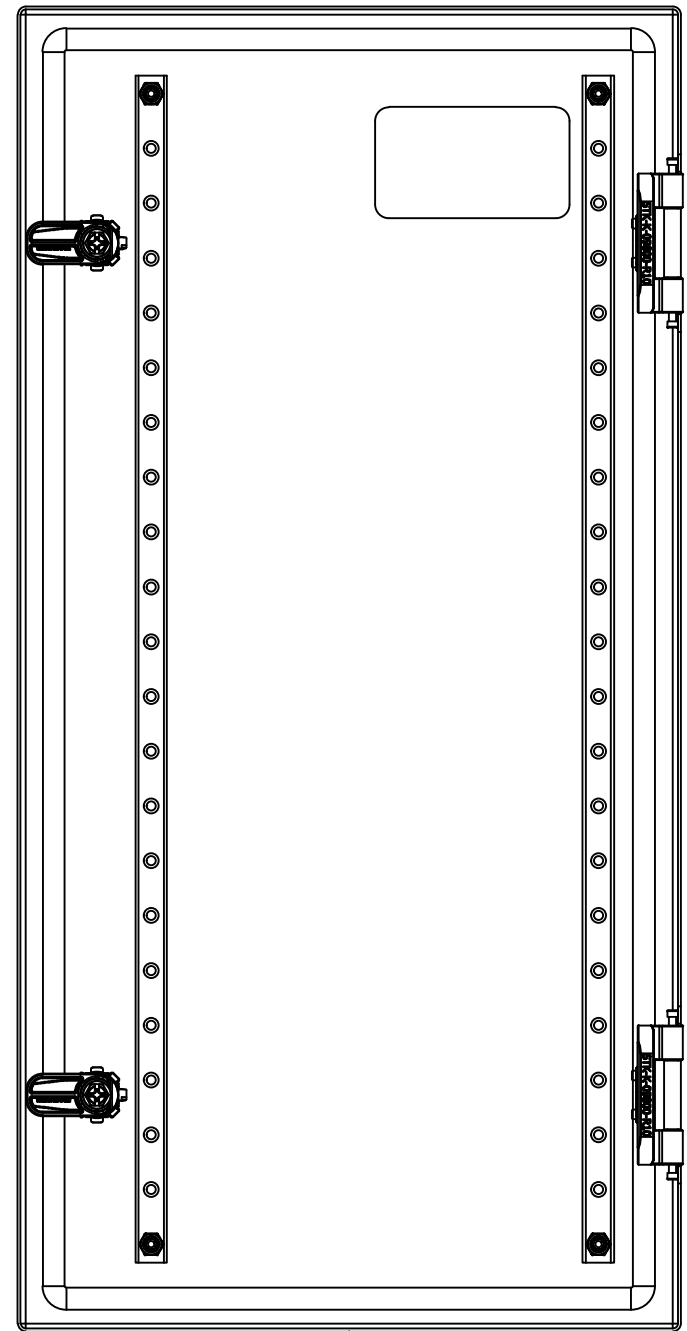

BACK

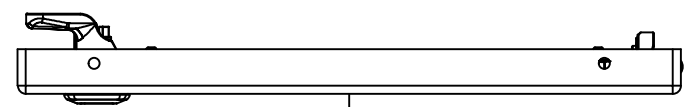

BOTTOM

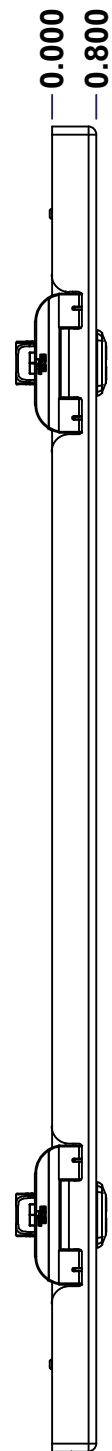

LEFT

0.000  
0.800

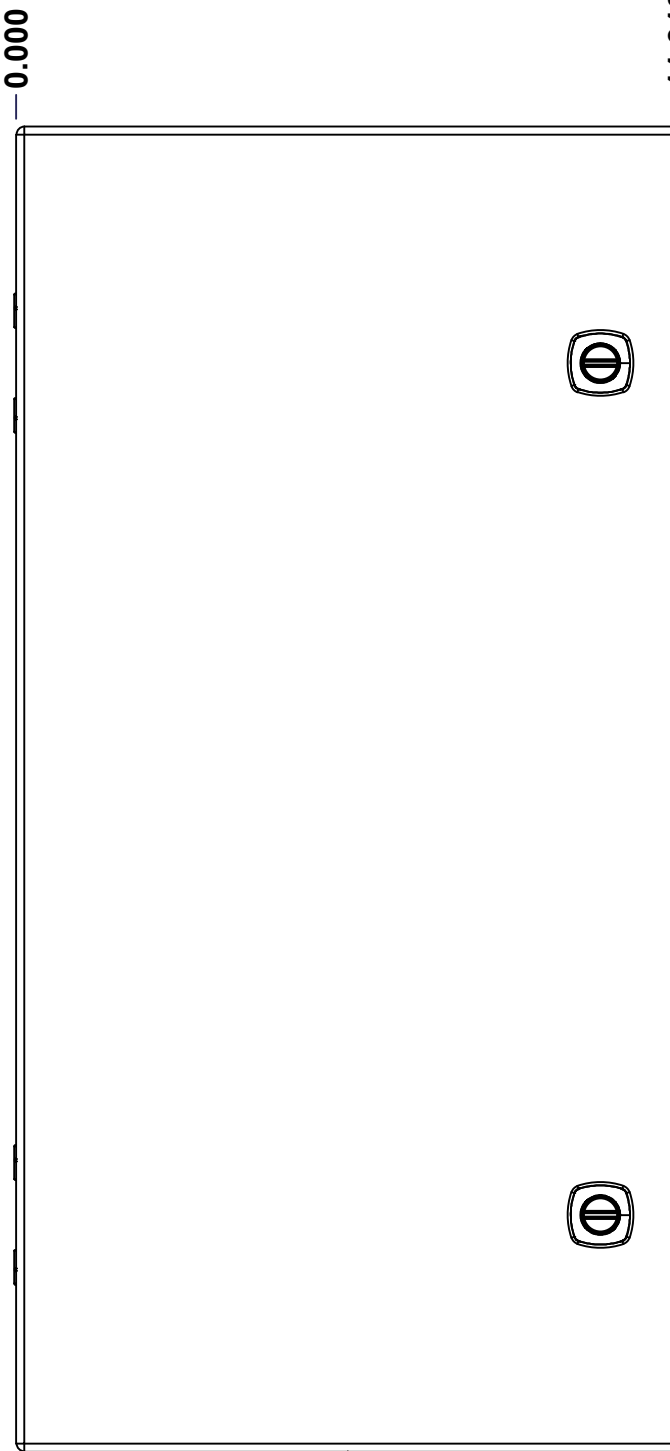

FRONT

0.000

11.918

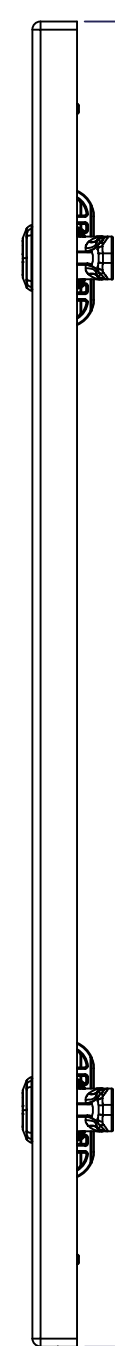

RIGHT

23.803

0.000

| No. | Revisions | Date | By/Par |
|-----|-----------|------|--------|
|     |           |      |        |
|     |           |      |        |
|     |           |      |        |
|     |           |      |        |

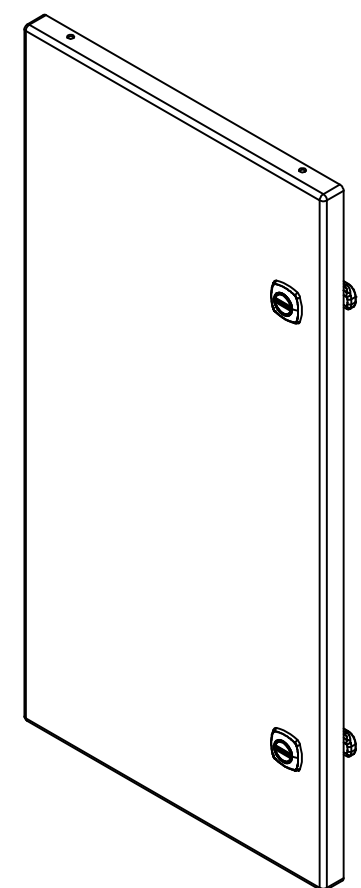

Isometric View



Tél: (450) 979-4373  
Fax: (450) 979-4626  
[www.exmweb.com](http://www.exmweb.com)

Flatness  
Aplatissement

Max 3.0mm

Projection

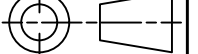

Customer Client

Date

Drawn By  
Dessiné Par

BoxCad: BoxCad

Date 06-Apr-17

Material  
Matière

16 Ga Cold Rolled A1008 CS Type B (1.4mm)

Color  
Couleur

Light Grey RAL7035

Finish  
Fini

Textured

Description

5412ES 24" x 12" Cover

Detail Rev.

Part Number  
Numéro Pièce

5412ESB241210C

Rev.

7

9

SEE BILL OF MATERIAL ON LAST PAGE

This drawing is confidential and must not be reproduced or used without the consent of EXM

Ce dessin est confidentiel et ne doit pas être reproduit ou utilisé sans le consentement de EXM

**STANDARD FEATURES ARE NOT LISTED IN THIS HOLE TABLE**

**HOLE TABLE - FRONT VIEW (CUSTOM FEATURE ONLY)**

| CUT-OUT | XDIM   | YDIM   | DESCRIPTION             |
|---------|--------|--------|-------------------------|
| 1       | 1.486  | 1.567  | STUD M6 x 18mm (Inside) |
| 2       | 1.486  | 22.236 | STUD M6 x 18mm (Inside) |
| 3       | 9.517  | 22.236 | STUD M6 x 18mm (Inside) |
| 4       | 9.517  | 1.567  | STUD M6 x 18mm (Inside) |
| -----   |        |        |                         |
| 5       | 3.750  | 21.000 | LABEL_EXM (Inside)      |
| 6       | 10.494 | 19.553 | LOCK 880 SCQ4-SL @ 0.0° |
| 7       | 10.494 | 4.250  | LOCK 880 SCQ4-SL @ 0.0° |

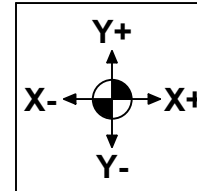
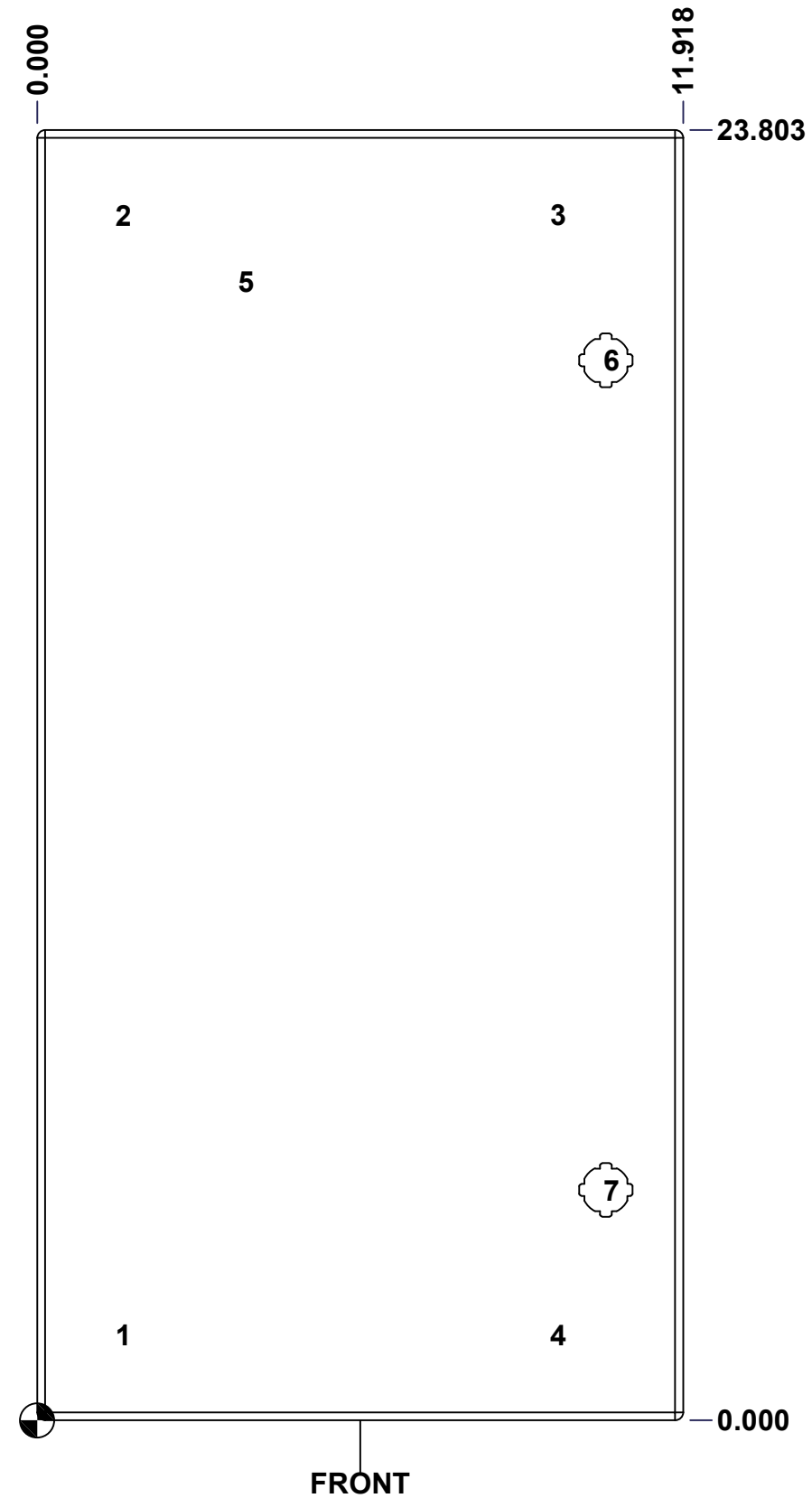

|                             |  |          |   |
|-----------------------------|--|----------|---|
| Description                 |  | Status   |   |
| 5412ES 24" x 12" Cover      |  | (NULL)   |   |
| Part Number<br>Numéro Pièce |  | Rev.     | 8 |
| <b>5412ESB241210C</b>       |  | <b>0</b> | 9 |

This drawing is confidential and must not be reproduced or used without the consent of EXM

Ce dessin est confidentiel et ne doit pas être reproduit ou utilisé sans le consentement de EXM

| No. | Revisions | Date | By/Par |
|-----|-----------|------|--------|
|     |           |      |        |
|     |           |      |        |
|     |           |      |        |
|     |           |      |        |
|     |           |      |        |

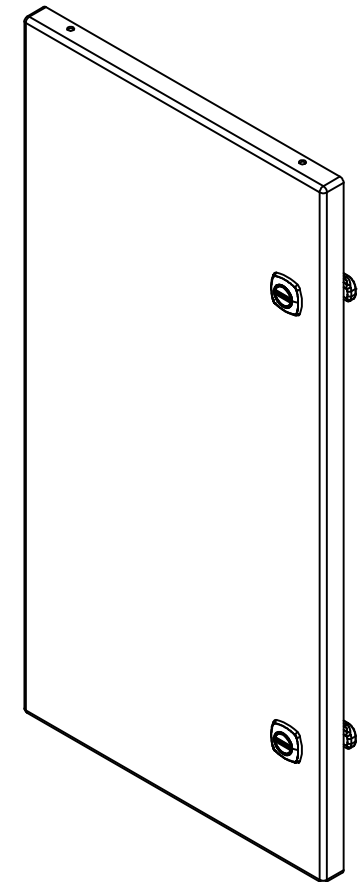

Isometric View



|  |   |
|--|---|
|  Tél: (450) 979-4373<br>Fax: (450) 979-4626<br><a href="http://www.exmweb.com">www.exmweb.com</a> | Flatness<br>Aplatissement   |
|  | Max 3.0mm   |
|  | Projection  |
|  |  |

|                         |                |
|-------------------------|----------------|
| Customer Client         | Date           |
| Drawn By<br>Dessiné Par | Date 06-Apr-17 |

|                     |   |
|---------------------|---|
| Material<br>Matière | 16 Ga Cold Rolled A1008 CS Type B (1.4mm) |
|---------------------|---|

|                  |                    |                |          |
|------------------|--------------------|----------------|----------|
| Color<br>Couleur | Light Grey RAL7035 | Finish<br>Fini | Textured |
|------------------|--------------------|----------------|----------|

|                        |             |
|------------------------|-------------|
| Description            | Detail Rev. |
| 5412ES 24" x 12" Cover |             |

|                             |          |   |
|-----------------------------|----------|---|
| Part Number<br>Numéro Pièce | Rev.     | 9 |
| <b>5412ESB241210C</b>       | <b>0</b> | 9 |

| QTY        | Part Number      | Rev | Description                                |
|------------|------------------|-----|--|
| 2          | STK-K-12500      | 19  | 5412 ES 1/4 Turn Lock                      |
| 1          | STK-S-00100      | 0   | 3.5" x 2" Silver Milar Flexcon Sticker     |
| 1          | STK-P-03820R     | 0   | Powder Paint (Light Grey / Rough Textured) |
| 2          | STK-Q-46020-24   | 5   | 5412 ES Vertical Door Stiffener 24"        |
| 4          | STK-Q-16055      | 1   | M6 x 18mm Stud (No Paint Cap Required)     |
| 1          | 5412ESB241210G   | 0   | 5412ES 24" x 12" Cover Gasket Part         |
| 1          | 5412ESB241210C-P | 0   | 5412ES 24" x 12" Cover Part                |
| 2          | STK-K-09800      | 10  | 5412 ES Hinge with 2 Captive Hinge Pins    |
| 4          | STK-Q-07220      | 1   | M6 Nylon Insert Lock Nut                   |
| Parts List |                  |     |  |

This drawing is confidential and must not be reproduced or used without the consent of EXM

Ce dessin est confidentiel et ne doit pas être reproduit ou utilisé sans le consentement de EXM

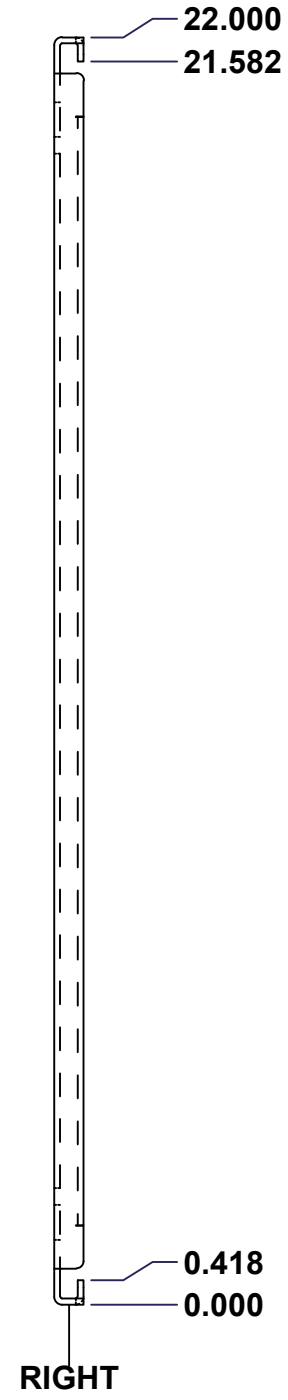
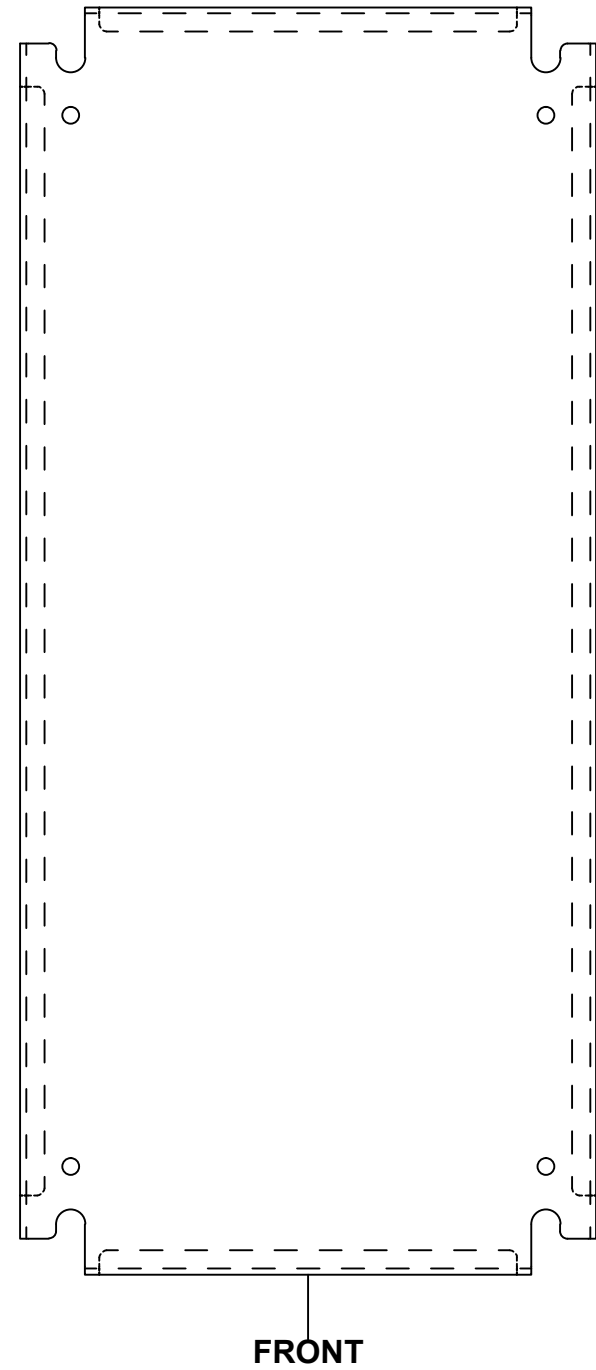
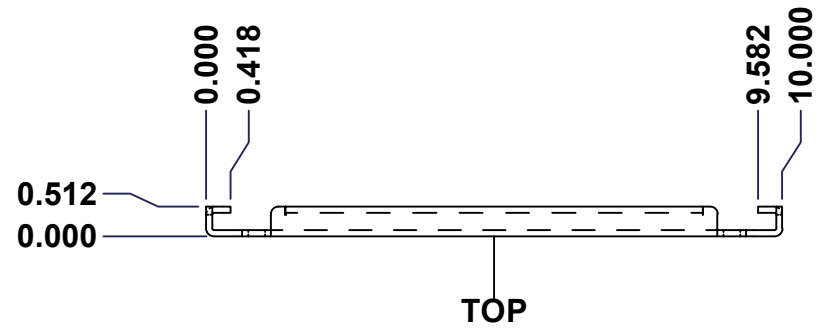

| No. | Revisions | Date | By/Par |
|-----|-----------|------|--------|
|     |           |      |        |
|     |           |      |        |
|     |           |      |        |
|     |           |      |        |
|     |           |      |        |

**Isometric View**

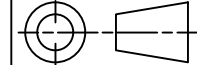

|  |   |
|--|---|
|  Tél: (450) 979-4373<br>Fax: (450) 979-4626<br>www.exmweb.com | Flatness<br>Aplatissement<br>Max 3.0mm  |
|  | Projection<br> |
| Customer Client  | Date  |
| Drawn By<br>Dessiné Par BoxCad   | Date 23-Jan-07  |
| Material<br>Matière  | See Part List   |
| Color<br>Couleur   | See Part List   |
| Finish<br>Fini   | See Part List   |
| Description  | Detail Rev.   |
| 881 SP - Inner Panel   |   |
| Part Number<br>Numéro Pièce  | Rev. 1  |
| <b>881 SP2412G</b>   | <b>0</b>  |

| Qty | Part Number   | Rev | Description               | Material         | Color     | Finish     |
|-----|---------------|-----|---------------------------|------------------|-----------|------------|
| 1   | 881 SP2412G-P | 0   | 881 SP - Inner Panel Part | 12 Ga Galvanized | Unpainted | Galvanized |

Parts List

This drawing is confidential and must not be reproduced or used without the consent of EXM

Ce dessin est confidentiel et ne doit pas être reproduit ou utilisé sans le consentement de EXM

| Table 1 |       |        | FRONT VIEW               |
|---------|-------|--------|--------------------------|
| CUT-OUT | XDIM  | YDIM   | DESCRIPTION              |
| 1       | 0.875 | 1.875  | GROUND HOLE (RND Ø0.290) |
| 2       | 9.125 | 1.875  | GROUND HOLE (RND Ø0.290) |
| 3       | 0.875 | 20.125 | GROUND HOLE (RND Ø0.290) |
| 4       | 9.125 | 20.125 | GROUND HOLE (RND Ø0.290) |

All knockouts are actual size / Les disques défonçables sont grandeur réel

| No. | Revisions | Date | By/Par |
|-----|-----------|------|--------|
|     |           |      |        |
|     |           |      |        |
|     |           |      |        |
|     |           |      |        |
|     |           |      |        |

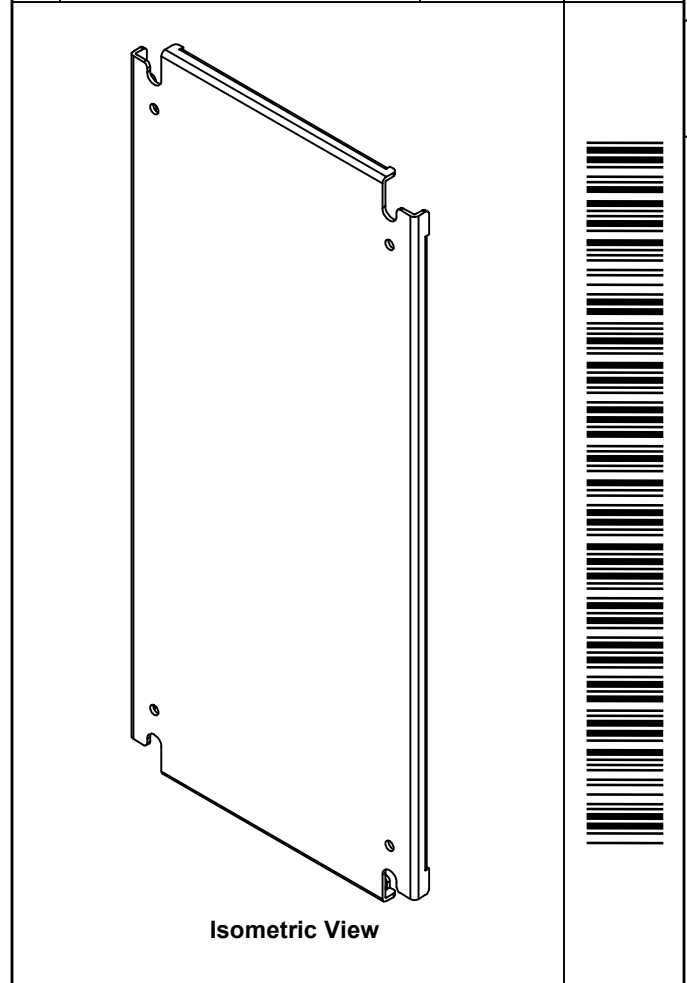
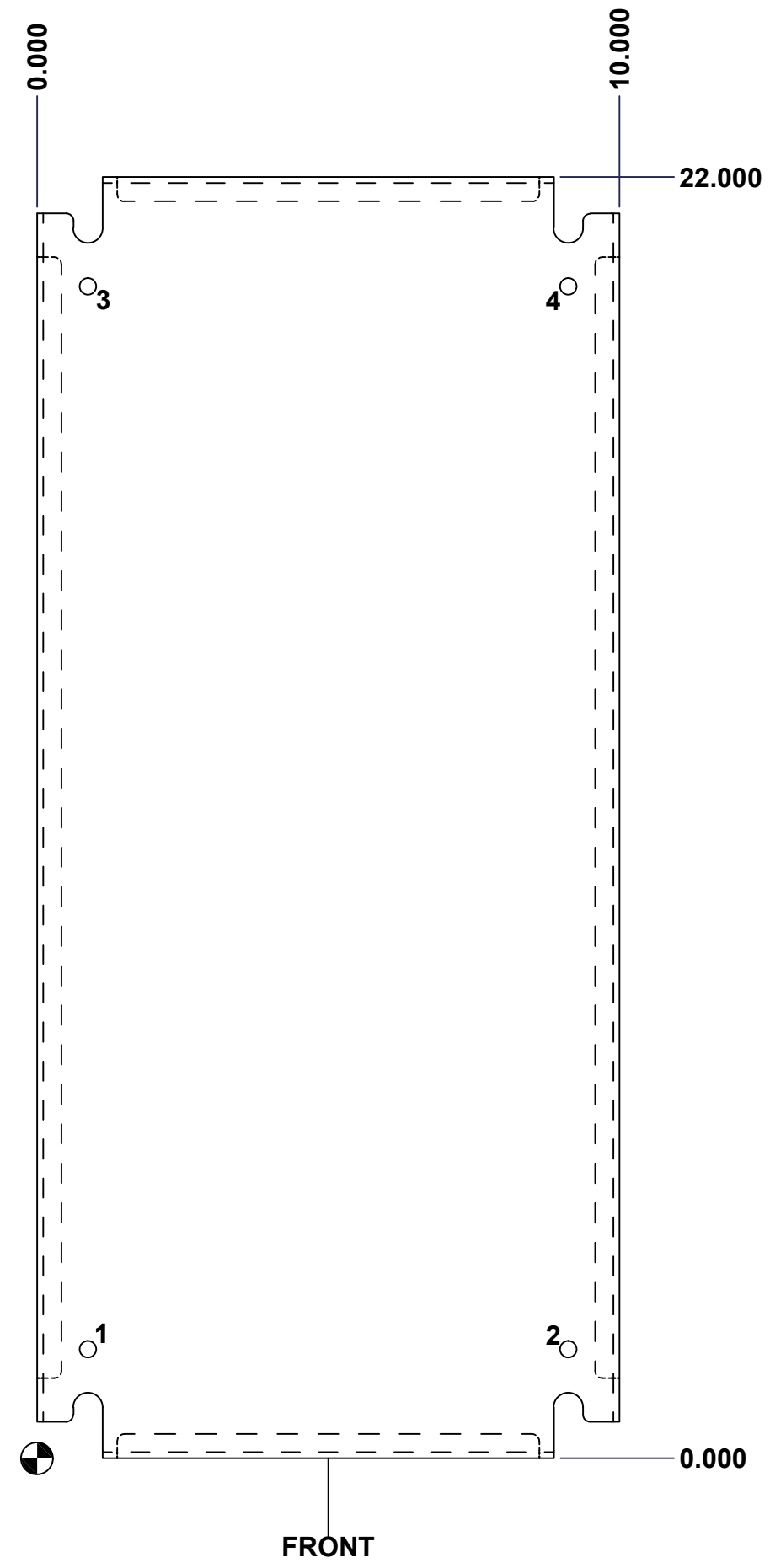

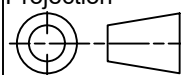
|  |   |
|--|---|
|  Tél: (450) 979-4373<br>Fax: (450) 979-4626<br>www.exmweb.com | Flatness<br>Aplatissement<br>Max 3.0mm  |
|  | Projection<br> |
| Customer Client  | Date  |
| Drawn By<br>Dessiné Par BoxCad   | Date 23-Jan-07  |
| Material<br>Matière  | See Part List   |
| Color<br>Couleur   | See Part List   |
| Finish<br>Fini   | See Part List   |
| Description<br>881 SP - Inner Panel  | Detail Rev.   |
| Part Number<br>Numéro Pièce<br><b>881 SP2412G</b>  | Rev. 0  |
|  | 2 / 2   |