

This drawing is confidential and must not be reproduced or used without the consent of EXM

Ce dessin est confidentiel et ne doit pas être reproduit ou utilisé sans le consentement de EXM

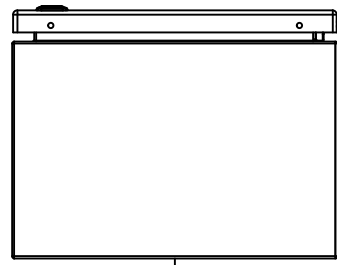

TOP

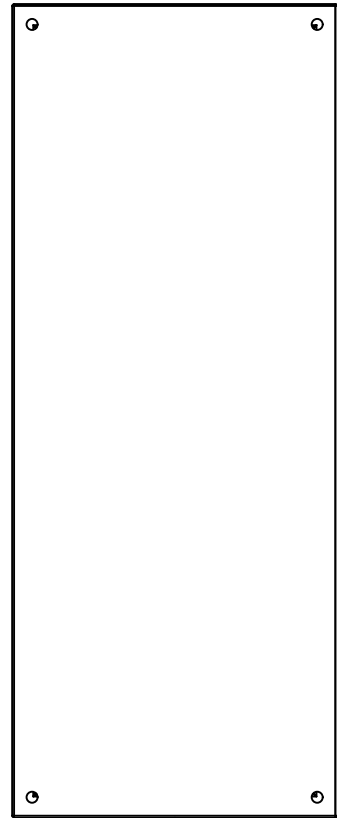

BACK

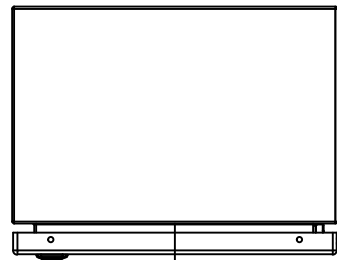

BOTTOM

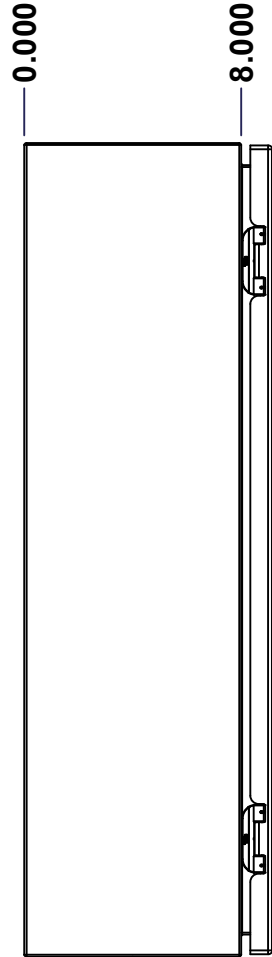

LEFT

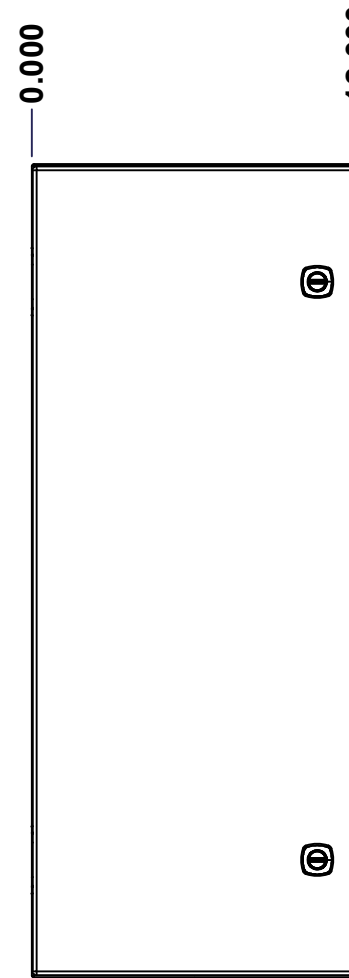

FRONT

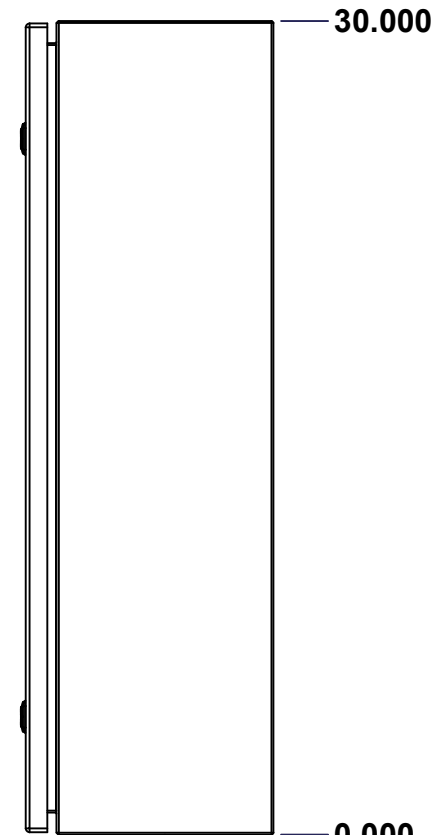

RIGHT

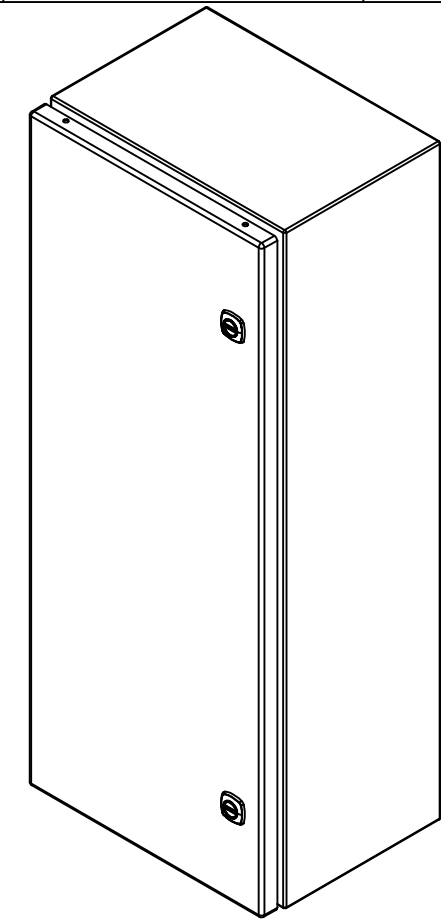

Isometric View

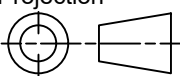

No.	Revisions	Date	By/Par

 Tél: (450) 979-4373 Fax: (450) 979-4626 www.exmweb.com		Flatness Aplatissement Max 3.0mm Projection 
Customer Client	Date	
Drawn By Dessiné Par	BoxCad: BoxCad	Date 27-Mar-17
Material Matière	16 Ga Cold Rolled A1008 CS Type B (1.4mm)	
Color Couleur	Light Grey RAL7035	Finish Fini Textured
Description 5412ES 30" x 12" x 8" Assembly		Detail Rev.
Part Number Numéro Pièce	5412ESB301208	Rev. 1 0

SEE BILL OF MATERIAL ON LAST PAGE

This drawing is confidential and must not be reproduced or used without the consent of EXM

Ce dessin est confidentiel et ne doit pas être reproduit ou utilisé sans le consentement de EXM

NOTE	
ITEM	DESCRIPTION
1	NEMA 4, 12 Enclosure (IP66)
2	C/W Standard ground studs on box and cover
3	C/W Standard door stiffener
4	C/W Standard inner panel (Included)
5	C/W Standard inner panel mounting studs

No.	Revisions	Date	By/Par

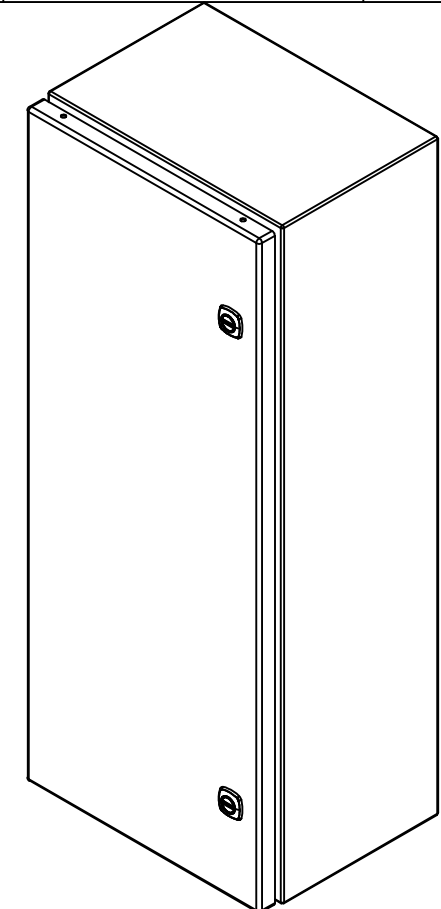

Isometric View

EXM
www.exm.com

Tél: (450) 979-4373
Fax: (450) 979-4626
www.exmweb.com

Flatness
Aplatissement
Max 3.0mm

Projection

Customer Client	Date
Drawn By Dessiné Par BoxCad: BoxCad	Date 27-Mar-17
Material Matière 16 Ga Cold Rolled A1008 CS Type B (1.4mm)	

Color Couleur Light Grey RAL7035	Finish Fini Textured
Description 5412ES 30" x 12" x 8" Assembly	Detail Rev.
Part Number Numéro Pièce 5412ESB301208	Rev. 0

PACKING		
ITEM	QTY	DESCRIPTION
Cardboard sleeve	2	Top and Bottom
Cardboard strip	2	Between back of enclosure and inner panel
Plastic bag	1	To protect cover surface and inside gasket
Plastic strap - Black	2	To Squeeze the 2 cardboard sleeve together
Packaging label	1	White label with product number

Qty	Part Number	Rev	Description
1	881 SP3012G	0	881 SP - Inner Panel
2	STK-K-01320	0	5412 ES Inner Panel Accessory Kit
1	STK-K-01800	5	5412 ES Accessory Kit
1	5412ESB301208C	0	5412ES 30" x 12" Cover
1	5412ESB301208B	0	5412ES 30" x 12" x 8" Body
2	STK-Q-04050-08	0	M6 x 8mm Hexagon Socket Head Machine Screw
Parts List			

This drawing is confidential and must not be reproduced or used without the consent of EXM

Ce dessin est confidentiel et ne doit pas être reproduit ou utilisé sans le consentement de EXM

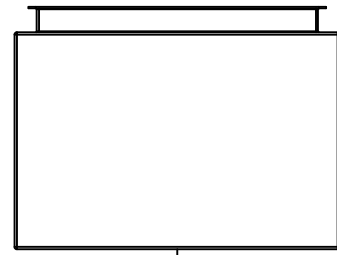

TOP

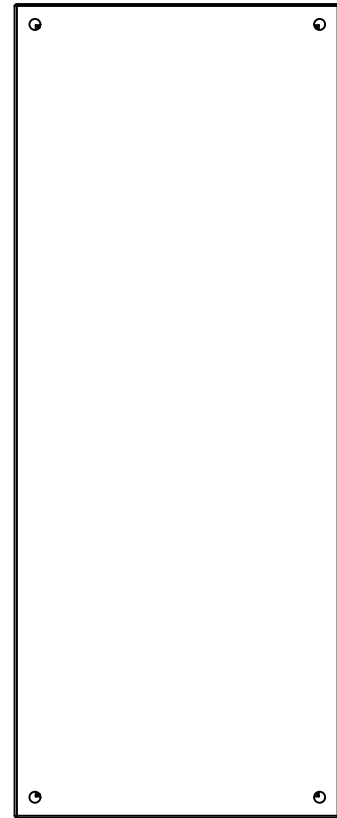

BACK

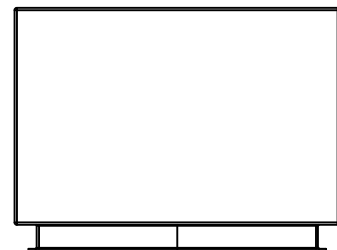

BOTTOM

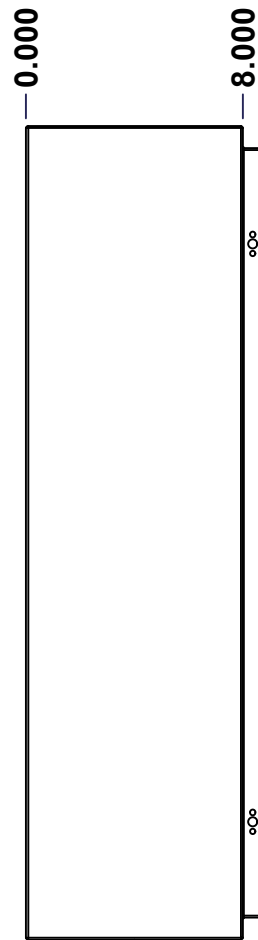

LEFT

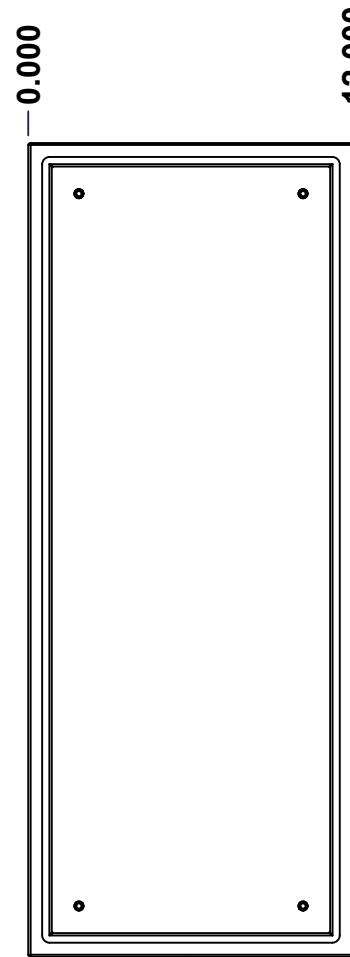

FRONT

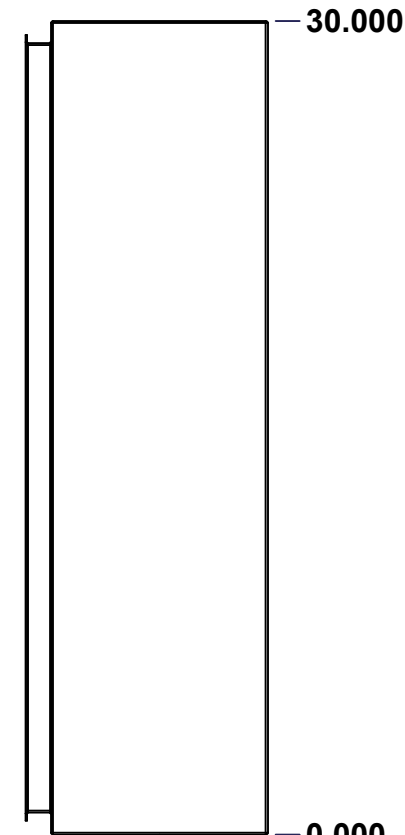

RIGHT

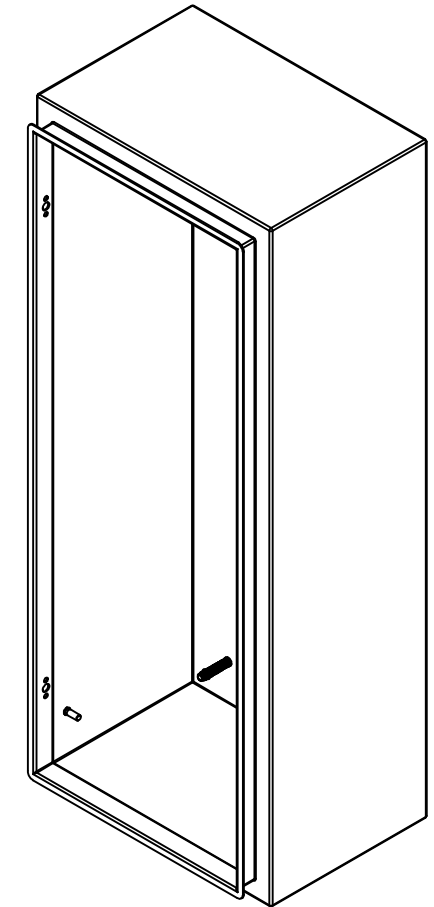

Isometric View

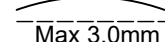
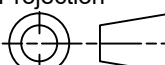

No.	Revisions	Date	By/Par

 Tél: (450) 979-4373 Fax: (450) 979-4626 www.exmweb.com		Flatness Aplatissement  Max 3.0mm Projection 
Customer Client	Date	
Drawn By Dessiné Par	BoxCad: BoxCad	Date 27-Mar-17
Material Matière	16 Ga Cold Rolled A1008 CS Type B (1.4mm)	
Color Couleur	Light Grey RAL7035	Finish Fini Textured
Description		Detail Rev.
5412ES 30" x 12" x 8" Body		
Part Number Numéro Pièce	Rev. 3	9
5412ESB301208B		0

SEE BILL OF MATERIAL ON LAST PAGE

This drawing is confidential and must not be reproduced or used without the consent of EXM

Ce dessin est confidentiel et ne doit pas être reproduit ou utilisé sans le consentement de EXM

STANDARD FEATURES ARE NOT LISTED IN THIS HOLE TABLE

HOLE TABLE - LEFT VIEW (CUSTOM FEATURE ONLY)

CUT-OUT	XDIM	YDIM	DESCRIPTION
1	6.500	2.000	GND STUD M6 x 16mm (Inside)

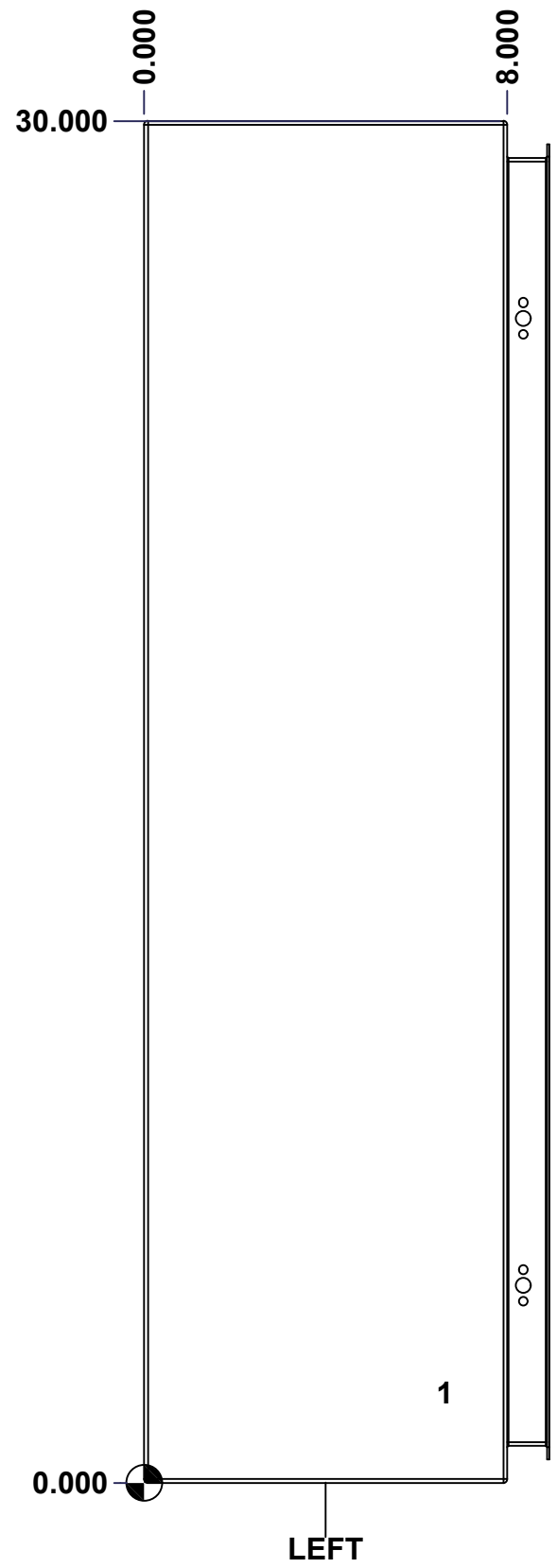

	Description	Status	
	5412ES 30" x 12" x 8" Body	(NULL)	
	Part Number Numéro Pièce	Rev.	
	5412ESB301208B	0	4/9

This drawing is confidential and must not be reproduced or used without the consent of EXM

Ce dessin est confidentiel et ne doit pas être reproduit ou utilisé sans le consentement de EXM

STANDARD FEATURES ARE NOT LISTED IN THIS HOLE TABLE

HOLE TABLE - BACK VIEW (CUSTOM FEATURE ONLY)

CUT-OUT	XDIM	YDIM	DESCRIPTION
1	1.875	1.875	IP STUD M8 x 35mm (Inside)
2	1.875	28.125	IP STUD M8 x 35mm (Inside)
3	10.125	28.125	IP STUD M8 x 35mm (Inside)
4	10.125	1.875	IP STUD M8 x 35mm (Inside)

5	11.250	0.750	RND Ø0.390
6	11.250	29.250	RND Ø0.390
7	0.750	29.250	RND Ø0.390
8	0.750	0.750	RND Ø0.390

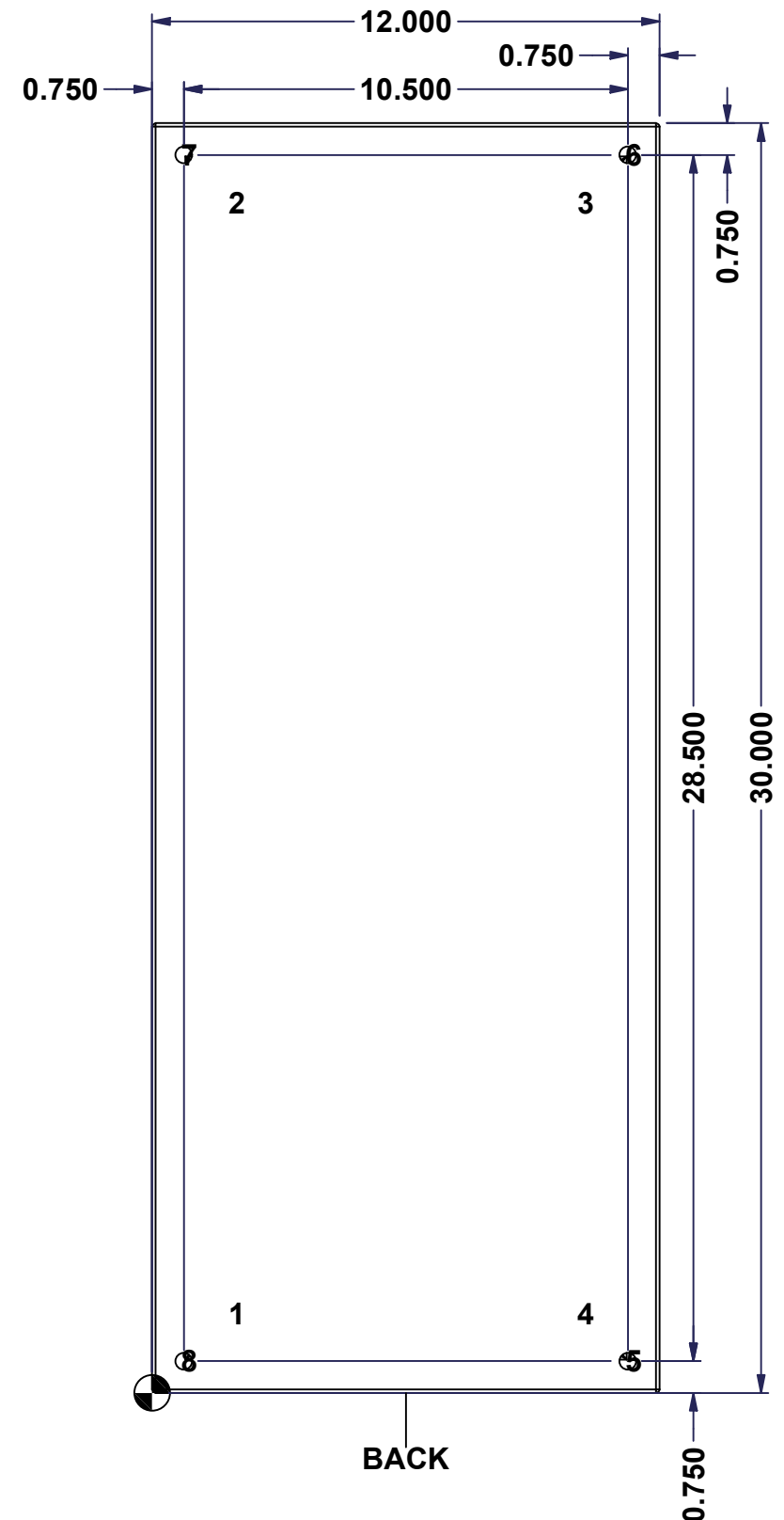

	Description	Status
	5412ES 30" x 12" x 8" Body	(NULL)
	Part Number Numéro Pièce	Rev.
	5412ESB301208B	0 / 5 / 9

This drawing is confidential and must not be reproduced or used without the consent of EXM

Ce dessin est confidentiel et ne doit pas être reproduit ou utilisé sans le consentement de EXM

No.	Revisions	Date	By/Par

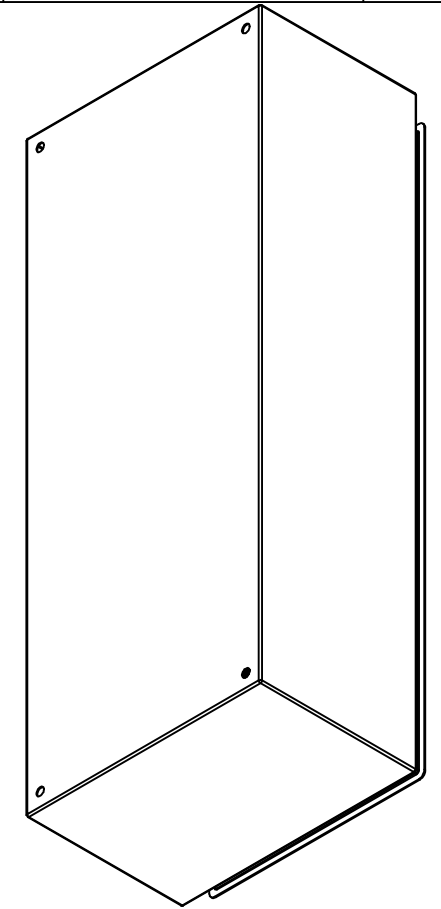

Isometric View

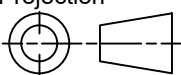

 Tél: (450) 979-4373 Fax: (450) 979-4626 www.exmweb.com		Flatness Aplatissement Max 3.0mm
Customer Client		Projection 
Drawn By Dessiné Par BoxCad: BoxCad		Date 27-Mar-17
Material Matière 16 Ga Cold Rolled A1008 CS Type B (1.4mm)		
Color Couleur Light Grey RAL7035	Finish Fini Textured	
Description 5412ES 30" x 12" x 8" Body		Detail Rev.
Part Number Numéro Pièce 5412ESB301208B		Rev. 6 0

Qty	Part Number	Rev	Description
1	STK-Q-16080	0	Ground Stud M6 x 16mm Steel
1	STK-P-03820R	0	Powder Paint (Light Grey / Rough Textured)
4	STK-Q-16005	1	Stud M8 x 35mm (No Paint Cap Required)
1	5412ESB301208B-P	0	5412ES 30" x 12" x 8" Body Part
Parts List			

This drawing is confidential and must not be reproduced or used without the consent of EXM

Ce dessin est confidentiel et ne doit pas être reproduit ou utilisé sans le consentement de EXM



TOP

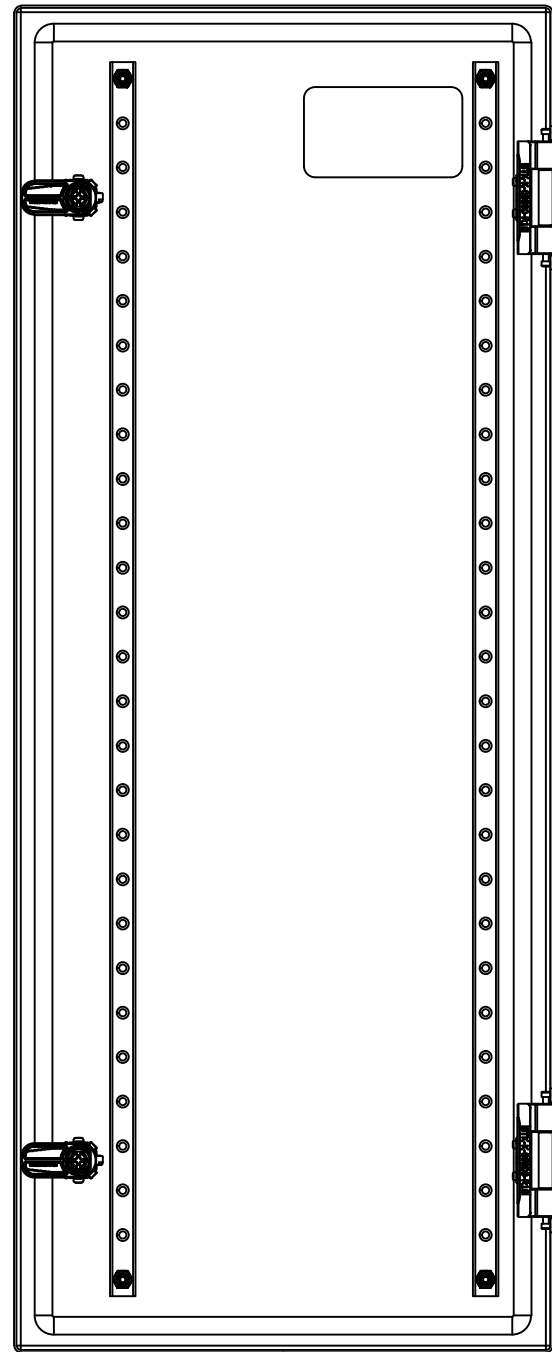

BACK

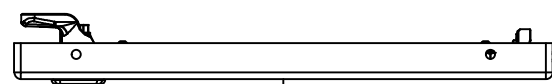

BOTTOM

0.000
0.800

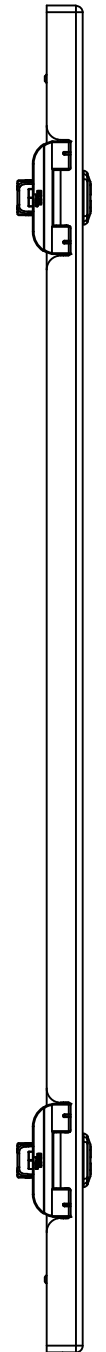

LEFT

0.000

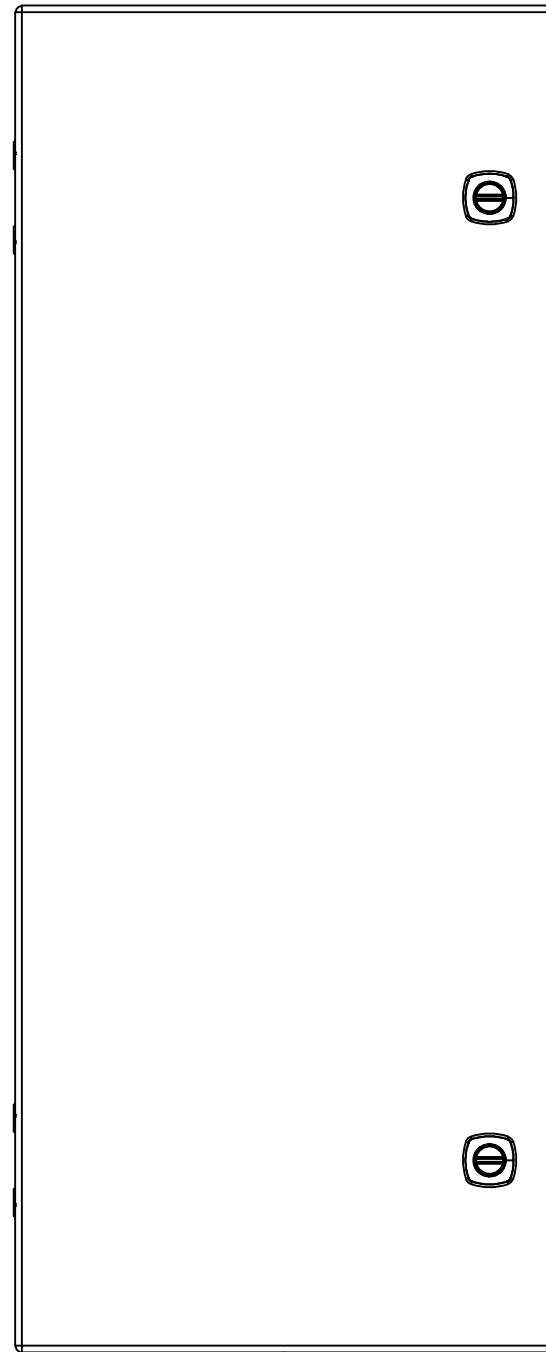

FRONT

11.918

29.803

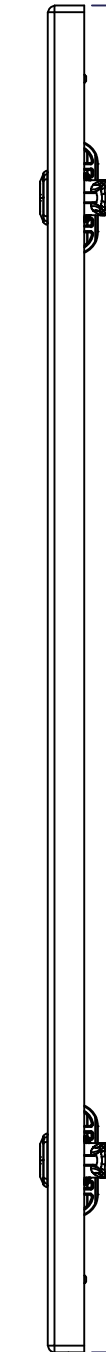

RIGHT

0.000

No.	Revisions	Date	By/Par

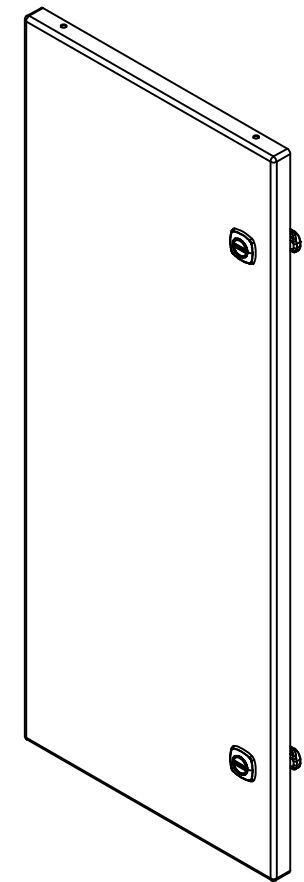

Isometric View



Tél: (450) 979-4373
Fax: (450) 979-4626
www.exmweb.com

Flatness
Aplatissement

Max 3.0mm

Projection

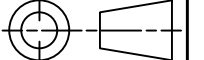

Customer Client _____ Date _____

Drawn By Dessiné Par BoxCad: BoxCad Date 27-Mar-17

Material Matière 16 Ga Cold Rolled A1008 CS Type B (1.4mm)

Color Couleur Light Grey RAL7035 Finish Fini Textured

Description 5412ES 30" x 12" Cover Detail Rev. _____

Part Number Numéro Pièce 5412ESB301208C Rev. 7
0 9

SEE BILL OF MATERIAL ON LAST PAGE

This drawing is confidential and must not be reproduced or used without the consent of EXM

Ce dessin est confidentiel et ne doit pas être reproduit ou utilisé sans le consentement de EXM

STANDARD FEATURES ARE NOT LISTED IN THIS HOLE TABLE

HOLE TABLE - FRONT VIEW (CUSTOM FEATURE ONLY)

CUT-OUT	XDIM	YDIM	DESCRIPTION
1	1.486	1.614	STUD M6 x 18mm (Inside)
2	1.486	28.189	STUD M6 x 18mm (Inside)
3	9.517	28.189	STUD M6 x 18mm (Inside)
4	9.517	1.614	STUD M6 x 18mm (Inside)

5	3.750	27.000	LABEL_EXM (Inside)
6	10.494	25.553	LOCK 880 SCQ4-SL @ 0.0°
7	10.494	4.250	LOCK 880 SCQ4-SL @ 0.0°

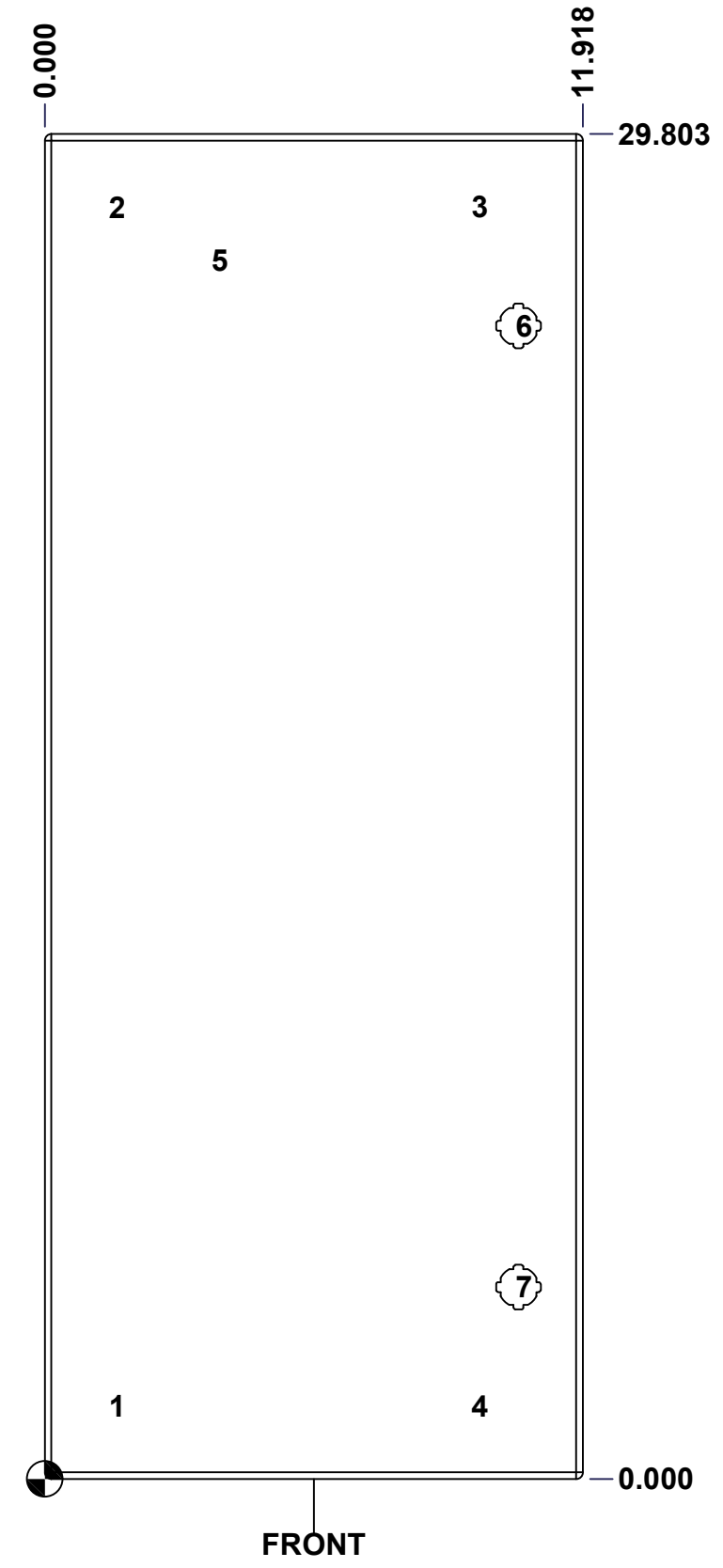

FRONT

	Description	Status
	5412ES 30" x 12" Cover	(NULL)
	Part Number Numéro Pièce	Rev.
	5412ESB301208C	0 / 8 / 9

This drawing is confidential and must not be reproduced or used without the consent of EXM

Ce dessin est confidentiel et ne doit pas être reproduit ou utilisé sans le consentement de EXM

No.	Revisions	Date	By/Par

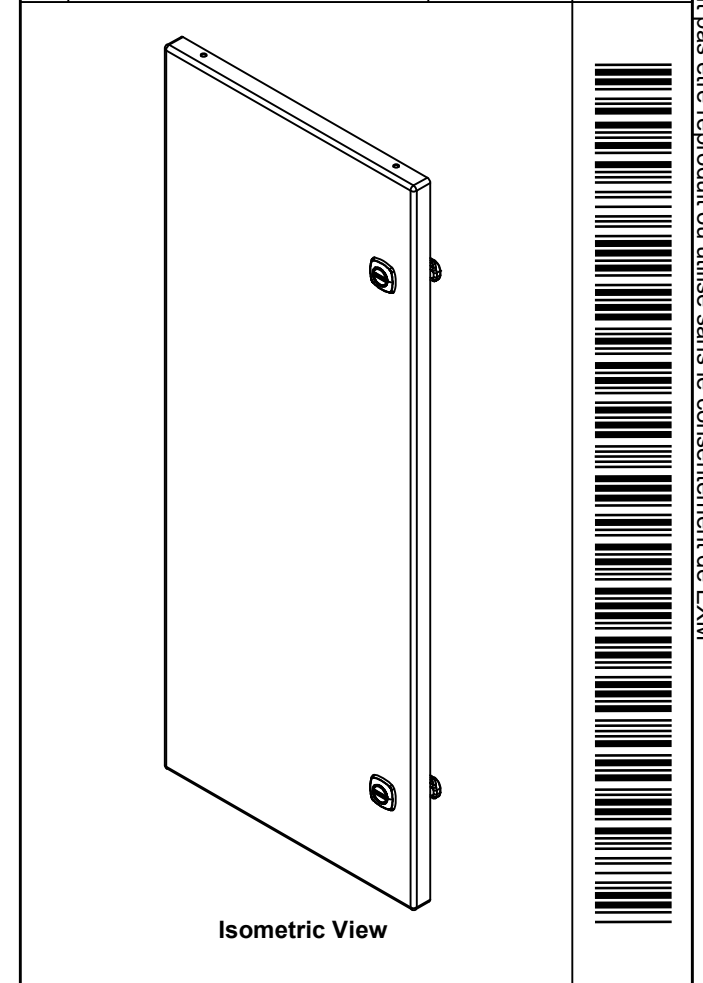

EXM
www.exmweb.com

Tél: (450) 979-4373
Fax: (450) 979-4626

Flatness
Aplatissement
Max 3.0mm

Projection

Customer Client	Date
Drawn By Dessiné Par	Date 27-Mar-17
Material Matière	16 Ga Cold Rolled A1008 CS Type B (1.4mm)
Color Couleur	Light Grey RAL7035
Finish Fini	Textured

QTY	Part Number	Rev	Description
2	STK-K-12500	19	5412 ES 1/4 Turn Lock
1	STK-S-00100	0	3.5" x 2" Silver Milar Flexcon Sticker
1	STK-P-03820R	0	Powder Paint (Light Grey / Rough Textured)
2	STK-Q-46020-30	6	5412 ES Vertical Door Stiffener 30"
4	STK-Q-16055	1	M6 x 18mm Stud (No Paint Cap Required)
1	5412ESB301208G	0	5412ES 30" x 12" Cover Gasket Part
1	5412ESB301208C-P	0	5412ES 30" x 12" Cover Part
2	STK-K-09800	10	5412 ES Hinge with 2 Captive Hinge Pins
4	STK-Q-07220	1	M6 Nylon Insert Lock Nut
Parts List			

Description	Detail Rev.
5412ES 30" x 12" Cover	
Part Number Numéro Pièce	Rev.
5412ESB301208C	0
	9

This drawing is confidential and must not be reproduced or used without the consent of EXM

Ce dessin est confidentiel et ne doit pas être reproduit ou utilisé sans le consentement de EXM

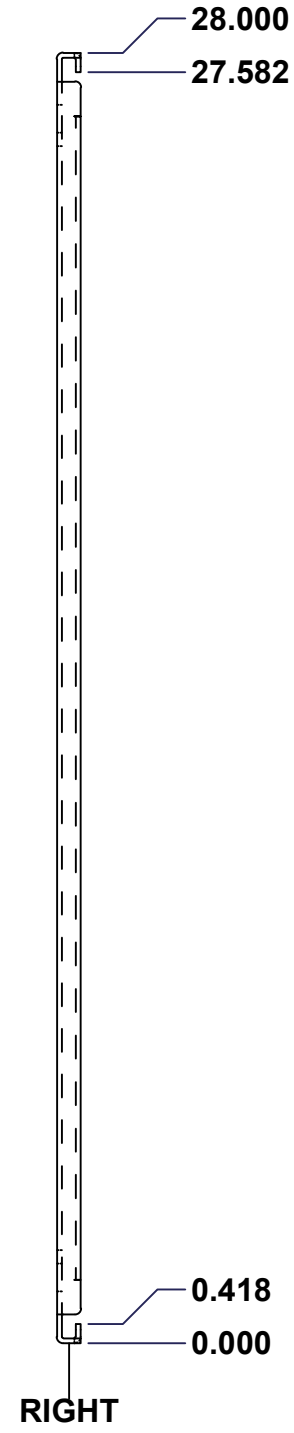
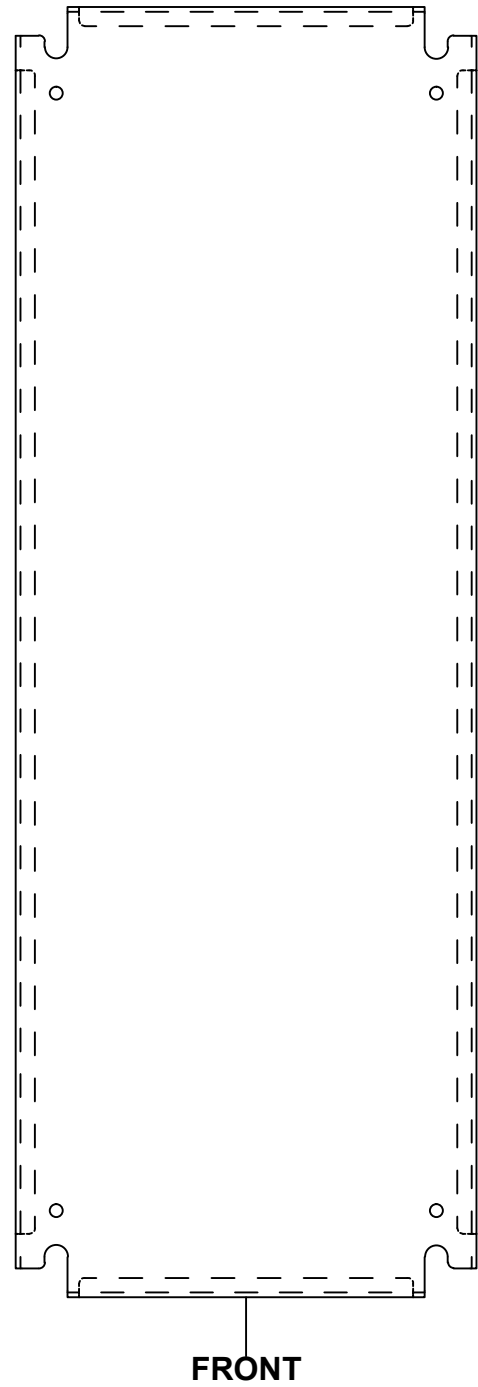
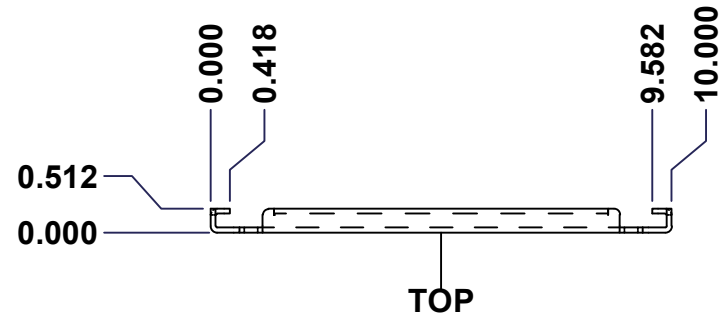

No.	Revisions	Date	By/Par

Isometric View

Tél: (450) 979-4373 Fax: (450) 979-4626 www.exmweb.com		Flatness Aplatissement Max 3.0mm Projection
Customer Client	Date	
Drawn By Dessiné Par	BoxCad	Date 23-Jan-07
Material Matière	See Part List	
Color Couleur	See Part List	Finish Fini See Part List
Description		Detail Rev.
881 SP - Inner Panel		
Part Number Numéro Pièce	Rev.	1
881 SP3012G	0	2

Qty	Part Number	Rev	Description	Material	Color	Finish
1	881 SP3012G-P	0	881 SP - Inner Panel Part	12 Ga Galvanized	Unpainted	Galvanized

Parts List

This drawing is confidential and must not be reproduced or used without the consent of EXM

Ce dessin est confidentiel et ne doit pas être reproduit ou utilisé sans le consentement de EXM

Table 1			FRONT VIEW
CUT-OUT	XDIM	YDIM	DESCRIPTION
1	0.875	1.875	GROUND HOLE (RND Ø0.290)
2	9.125	1.875	GROUND HOLE (RND Ø0.290)
3	0.875	26.125	GROUND HOLE (RND Ø0.290)
4	9.125	26.125	GROUND HOLE (RND Ø0.290)

All knockouts are actual size / Les disques défonçables sont grandeur réel

No.	Revisions	Date	By/Par

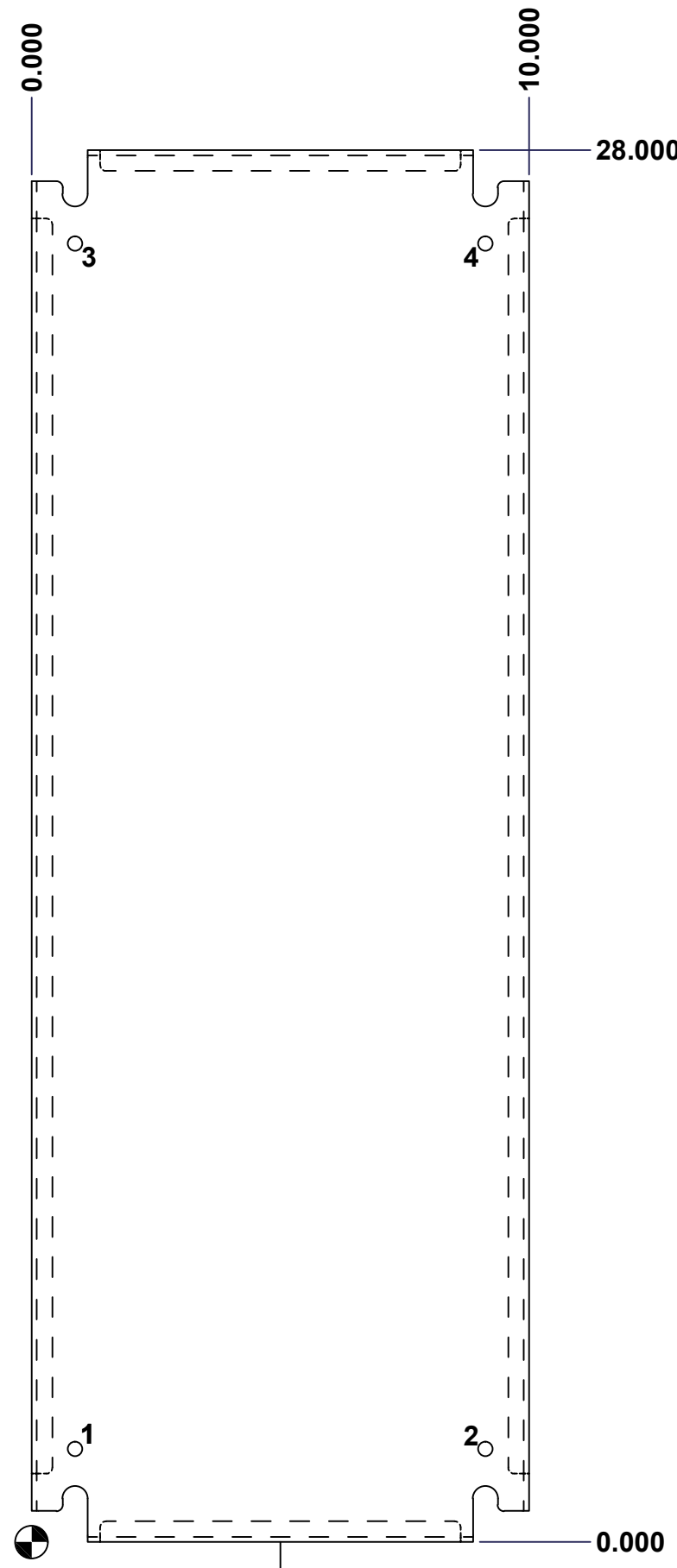

Isometric View

<p>Tél: (450) 979-4373 Fax: (450) 979-4626 www.exmweb.com</p>		Flatness Aplatissement
		Max 3.0mm
Customer Client Drawn By / Dessiné Par: BoxCad Material / Matière: See Part List Color / Couleur: See Part List Finish / Fini: See Part List Description: 881 SP - Inner Panel Part Number / Numéro Pièce: 881 SP3012G		Projection
		Date: 23-Jan-07
Detail Rev.		Rev. 2
		0