

This drawing is confidential and must not be reproduced or used without the consent of EXM

Ce dessin est confidentiel et ne doit pas être reproduit ou utilisé sans le consentement de EXM

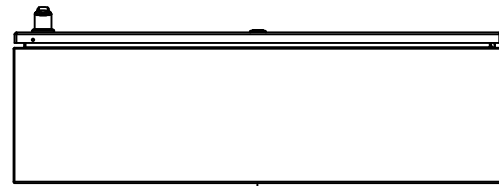

TOP

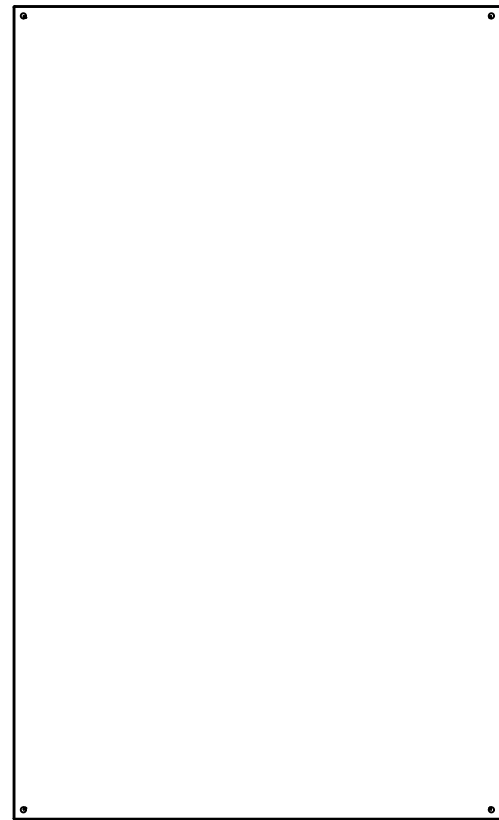

BACK



BOTTOM

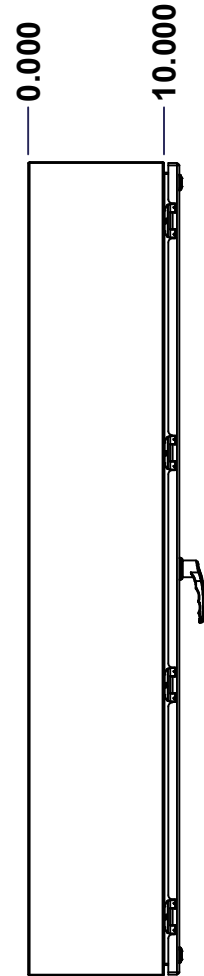

LEFT

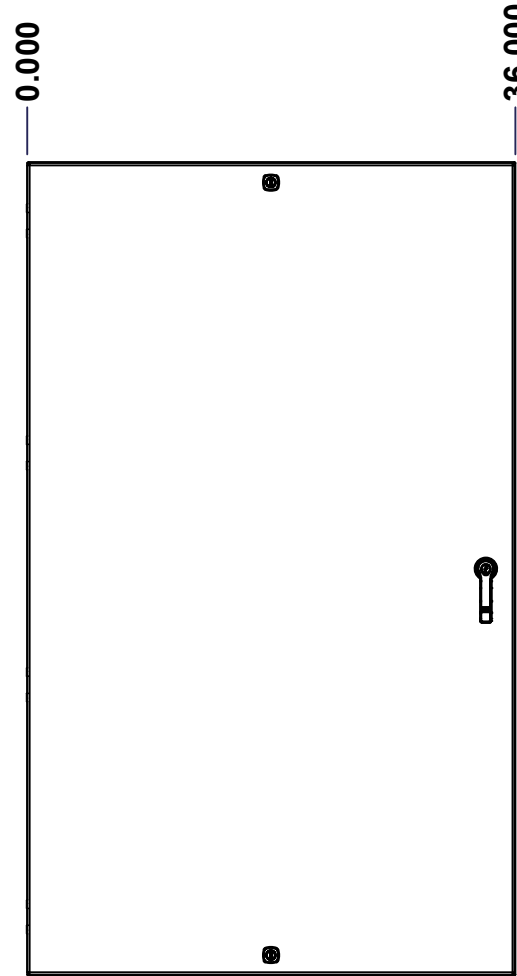

FRONT

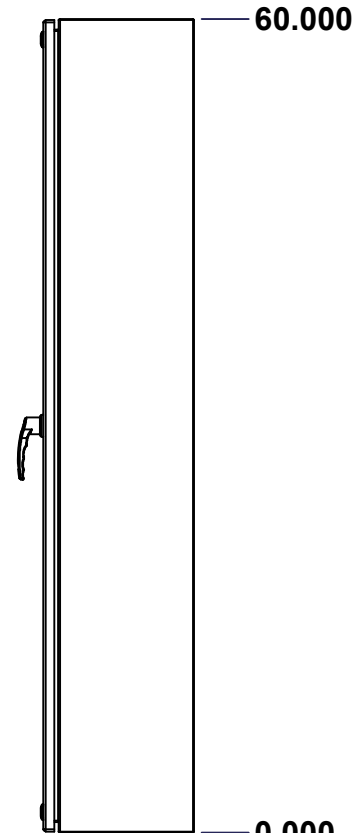

RIGHT

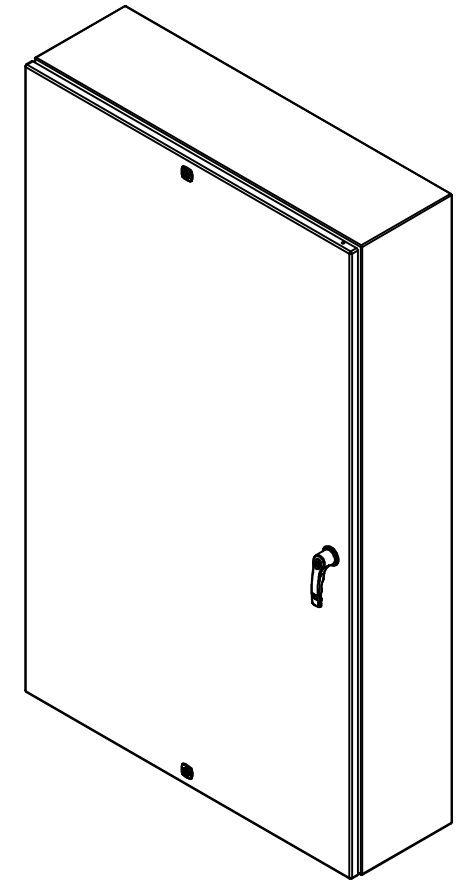

Isometric View

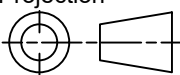

No.	Revisions	Date	By/Par

 Tél: (450) 979-4373 Fax: (450) 979-4626 www.exmweb.com		Flatness Aplatissement Max 3.0mm Projection 
Customer Client	Date	
Drawn By Dessiné Par	BoxCad: BoxCad	Date 17-Apr-17
Material Matière	14 Ga Cold Rolled A1008 CS Type B (1.7mm)	
Color Couleur	Light Grey RAL7035	Finish Fini Textured
Description	Detail Rev.	
5412ES 60" x 36" x 10" Assembly		
Part Number Numéro Pièce	Rev.	1
5412ESB603610	0	9

SEE BILL OF MATERIAL ON LAST PAGE

This drawing is confidential and must not be reproduced or used without the consent of EXM

Ce dessin est confidentiel et ne doit pas être reproduit ou utilisé sans le consentement de EXM

NOTE	
ITEM	DESCRIPTION
1	NEMA 4, 12 Enclosure (IP66)
2	C/W Standard ground studs on box and cover
3	C/W Standard door stiffener
4	C/W Standard inner panel (Included)
5	C/W Standard inner panel mounting studs

No.	Revisions	Date	By/Par

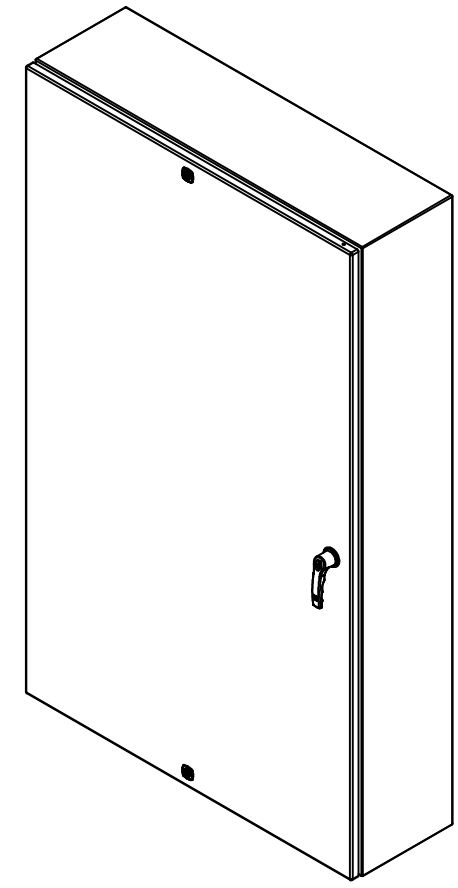

Isometric View

 Tél: (450) 979-4373
 Fax: (450) 979-4626
www.exmweb.com

Flatness
 Aplatissement
 Max 3.0mm
 Projection

Customer Client	Date
Drawn By Dessiné Par BoxCad: BoxCad	Date 17-Apr-17
Material Matière 14 Ga Cold Rolled A1008 CS Type B (1.7mm)	

Color Couleur Light Grey RAL7035	Finish Fini Textured
-------------------------------------	-------------------------

Description 5412ES 60" x 36" x 10" Assembly	Detail Rev.
--	-------------

Part Number Numéro Pièce 5412ESB603610	Rev. 0	2 9
---	------------------	----------------------

PACKING		
ITEM	QTY	DESCRIPTION
Cardboard sleeve	2	Top and Bottom
Cardboard strip	2	Between back of enclosure and inner panel
Plastic bag	1	To protect cover surface and inside gasket
Cardboard corner	4	To reinforced for the plastic strap tightening
Plastic strap - Black	2	To Squeeze the 2 cardboard sleeve together
Packaging label	3	White label with PN
Plastic strap- Green	2	To secure the enclosure to the wood pallet
Wood Pallet	1	2" deeper and 3" larger than enclosure size

Qty	Part Number	Rev	Description
1	881 SP6036G	0	881 SP - Inner Panel
4	STK-K-01320	0	5412 ES Inner Panel Accessory Kit
1	STK-K-01800	5	5412 ES Accessory Kit
1	5412ESB603610C	0	5412ES 60" x 36" Cover
1	5412ESB603610B	0	5412ES 60" x 36" x 10" Body
4	STK-Q-04050-08	0	M6 x 8mm Hexagon Socket Head Machine Screw
Parts List			

This drawing is confidential and must not be reproduced or used without the consent of EXM

Ce dessin est confidentiel et ne doit pas être reproduit ou utilisé sans le consentement de EXM

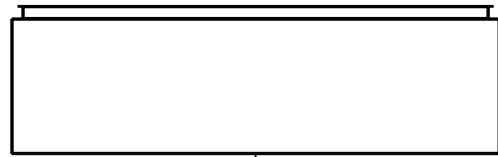

TOP

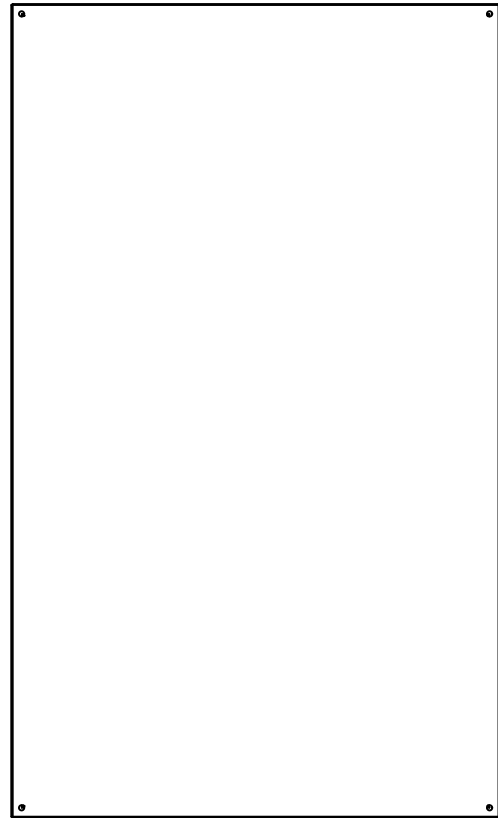

BACK



BOTTOM

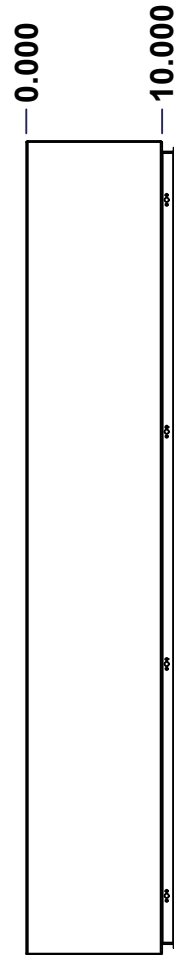

LEFT

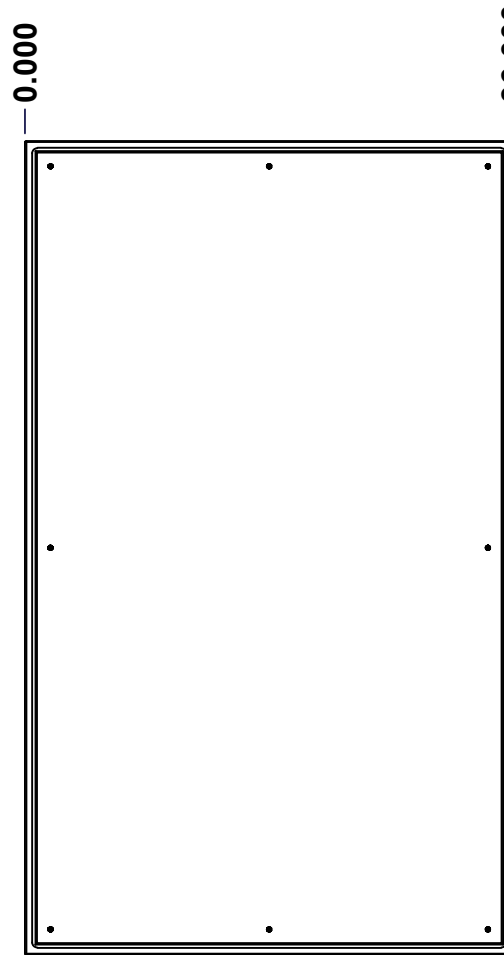

FRONT

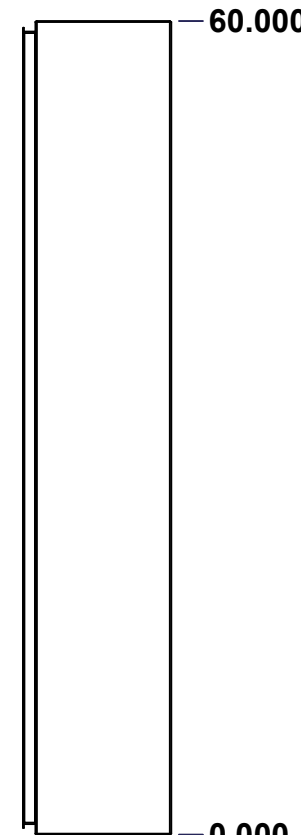

RIGHT

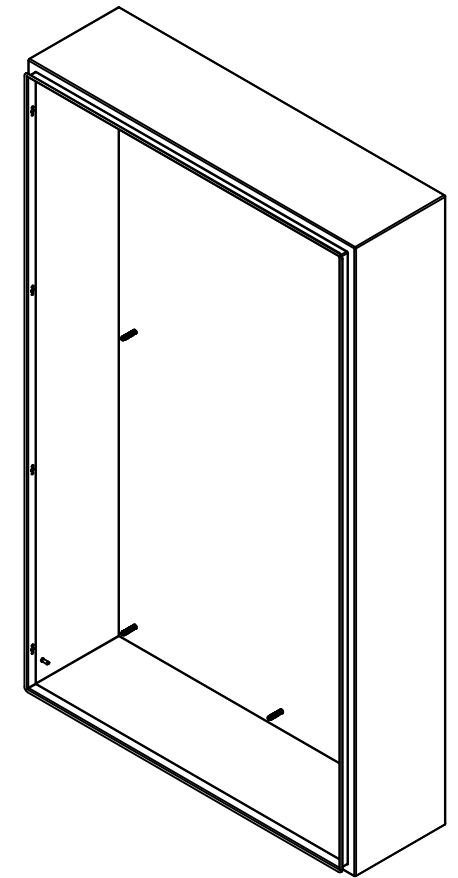

Isometric View

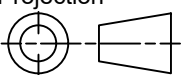

No.	Revisions	Date	By/Par

 Tél: (450) 979-4373 Fax: (450) 979-4626 www.exmweb.com		Flatness Aplatissement Max 3.0mm Projection 
Customer Client	Date	
Drawn By Dessiné Par	BoxCad: BoxCad	Date 17-Apr-17
Material Matière	14 Ga Cold Rolled A1008 CS Type B (1.7mm)	
Color Couleur	Light Grey RAL7035	Finish Fini Textured
Description	Detail Rev.	
5412ES 60" x 36" x 10" Body		
Part Number Numéro Pièce	Rev. 0	3 9

SEE BILL OF MATERIAL ON LAST PAGE

5412ESB603610B

This drawing is confidential and must not be reproduced or used without the consent of EXM

Ce dessin est confidentiel et ne doit pas être reproduit ou utilisé sans le consentement de EXM

STANDARD FEATURES ARE NOT LISTED IN THIS HOLE TABLE			
HOLE TABLE - LEFT VIEW (CUSTOM FEATURE ONLY)			
CUT-OUT	XDIM	YDIM	DESCRIPTION
1	8.500	2.000	GND STUD M6 x 16mm (Inside)

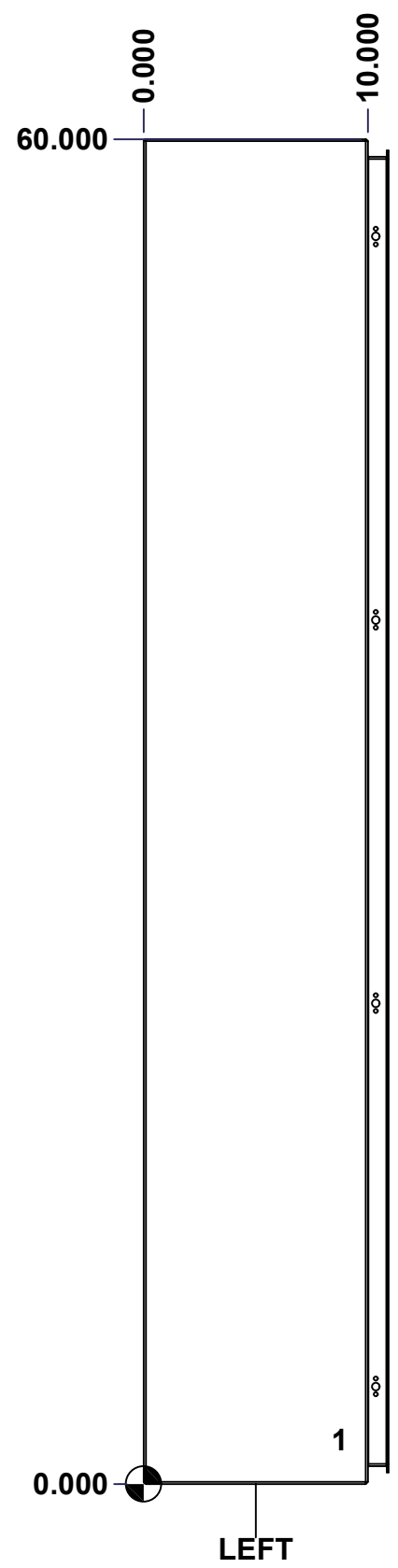

	Description	Status	
	5412ES 60" x 36" x 10" Body	(NULL)	
	Part Number Numéro Pièce	Rev.	
	5412ESB603610B	0	4 9

This drawing is confidential and must not be reproduced or used without the consent of EXM

Ce dessin est confidentiel et ne doit pas être reproduit ou utilisé sans le consentement de EXM

STANDARD FEATURES ARE NOT LISTED IN THIS HOLE TABLE

HOLE TABLE - BACK VIEW (CUSTOM FEATURE ONLY)

CUT-OUT	XDIM	YDIM	DESCRIPTION
1	1.875	1.875	IP STUD M8 x 35mm (Inside)
2	1.875	58.125	IP STUD M8 x 35mm (Inside)
3	34.125	58.125	IP STUD M8 x 35mm (Inside)
4	34.125	1.875	IP STUD M8 x 35mm (Inside)
5	1.875	30.000	IP STUD M8 x 35mm (Inside)
6	34.125	30.000	IP STUD M8 x 35mm (Inside)
7	18.000	1.875	IP STUD M8 x 35mm (Inside)
8	18.000	58.125	IP STUD M8 x 35mm (Inside)

9	35.250	59.250	RND Ø0.390
10	0.750	59.250	RND Ø0.390
11	0.750	0.750	RND Ø0.390
12	35.250	0.750	RND Ø0.390

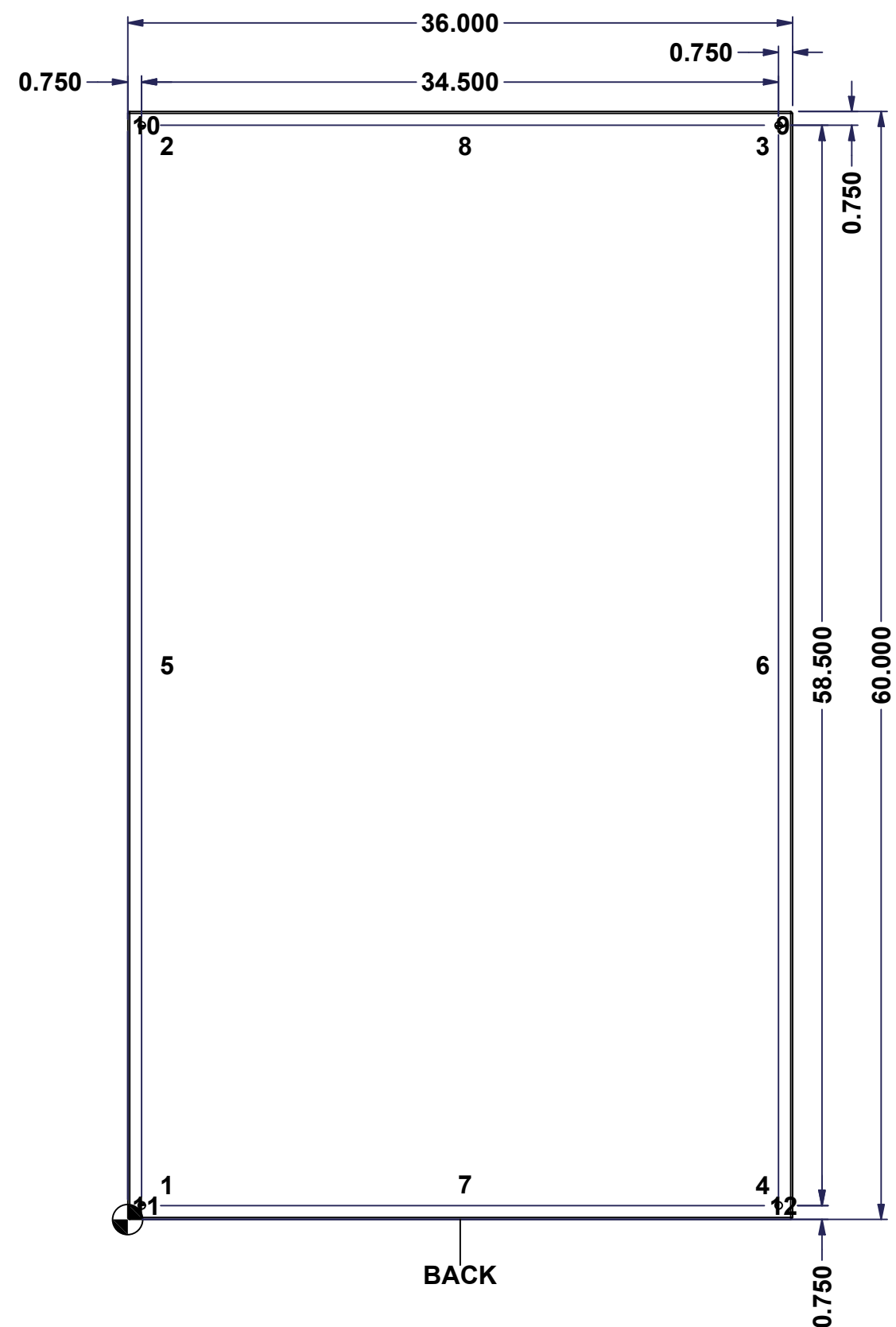

BACK

	Description	Status	
	5412ES 60" x 36" x 10" Body	(NULL)	
	Part Number Numéro Pièce	Rev.	5
	5412ESB603610B	0	9

This drawing is confidential and must not be reproduced or used without the consent of EXM

Ce dessin est confidentiel et ne doit pas être reproduit ou utilisé sans le consentement de EXM

No.	Revisions	Date	By/Par

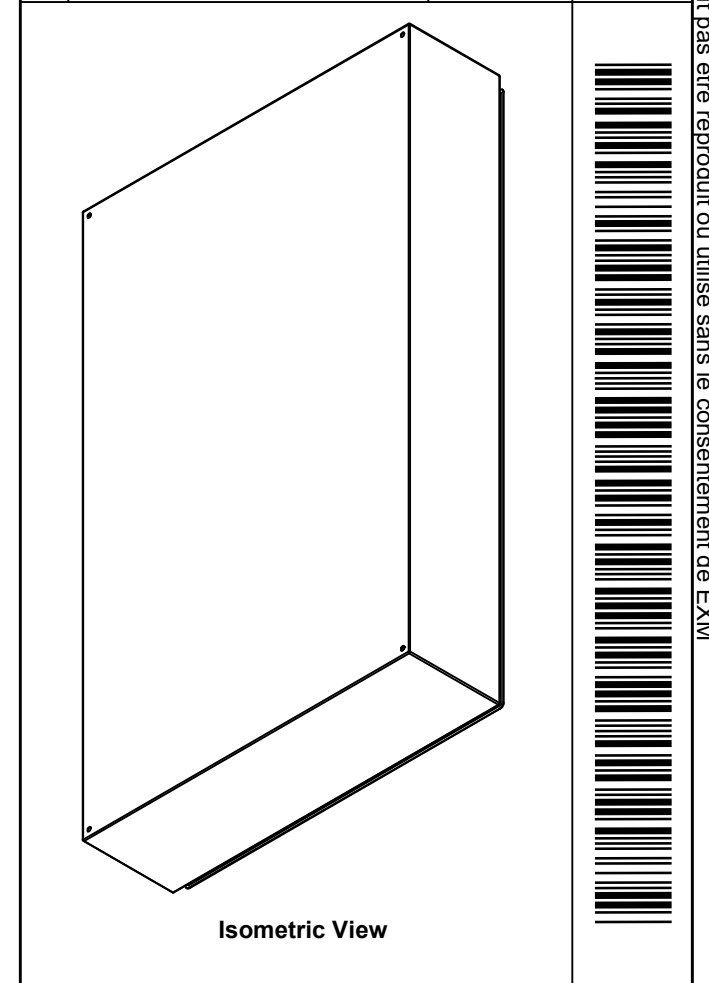

Isometric View

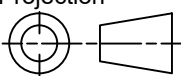
 Tél: (450) 979-4373 Fax: (450) 979-4626 www.exmweb.com		Flatness Aplatissement Max 3.0mm
Customer Client		Projection 
Drawn By / Dessiné Par: BoxCad: BoxCad		Date: 17-Apr-17
Material / Matière: 14 Ga Cold Rolled A1008 CS Type B (1.7mm)		
Color / Couleur: Light Grey RAL7035	Finish / Fini: Textured	
Description: 5412ES 60" x 36" x 10" Body		Detail Rev.
Part Number / Numéro Pièce: 5412ESB603610B		Rev. 6 / 9

Qty	Part Number	Rev	Description
1	STK-Q-16080	0	Ground Stud M6 x 16mm Steel
1	STK-P-03820R	0	Powder Paint (Light Grey / Rough Textured)
8	STK-Q-16005	1	Stud M8 x 35mm (No Paint Cap Required)
1	5412ESB603610B-P	0	5412ES 60" x 36" x 10" Body Part
Parts List			

This drawing is confidential and must not be reproduced or used without the consent of EXM

Ce dessin est confidentiel et ne doit pas être reproduit ou utilisé sans le consentement de EXM

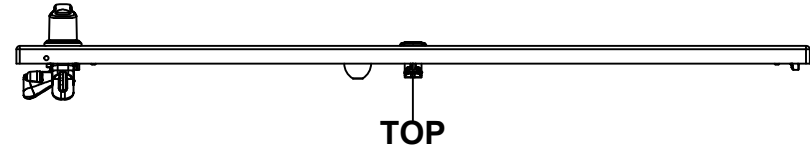

TOP

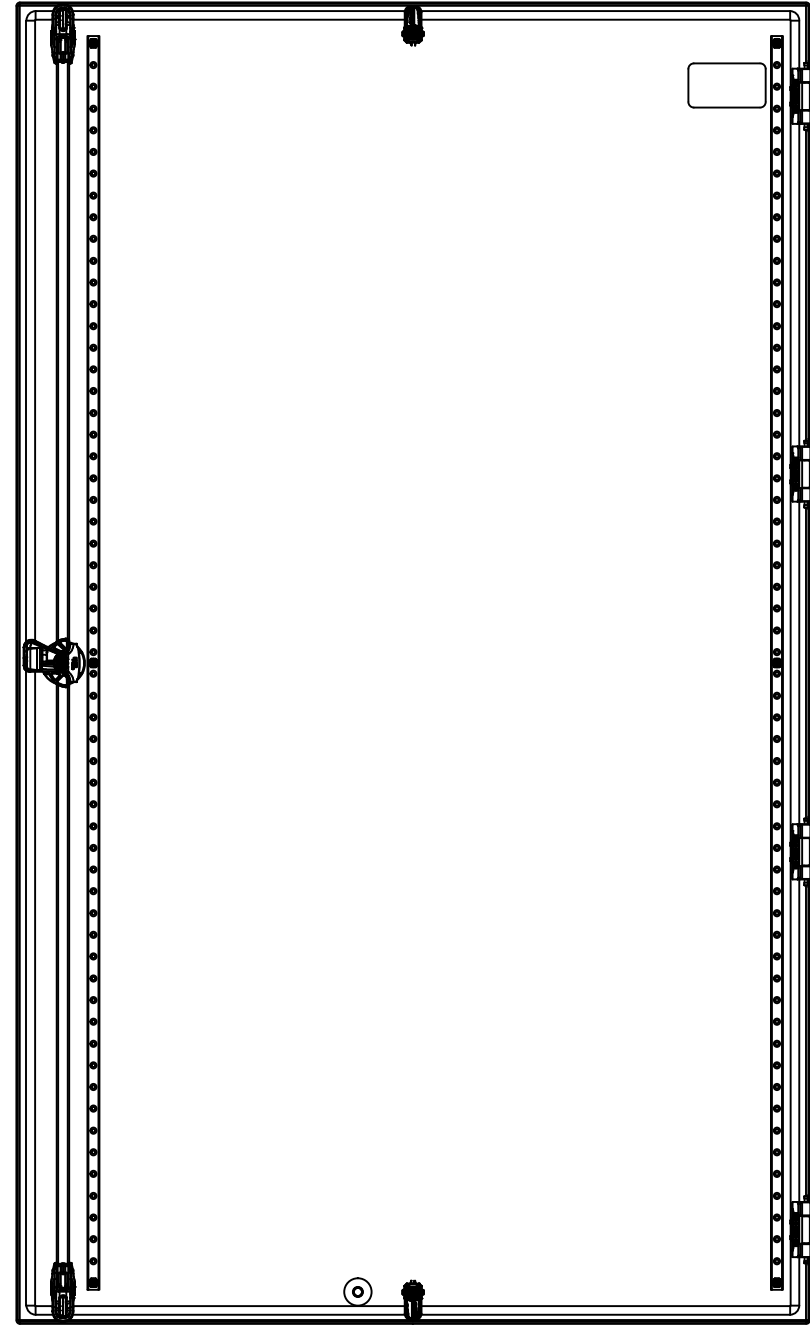

BACK

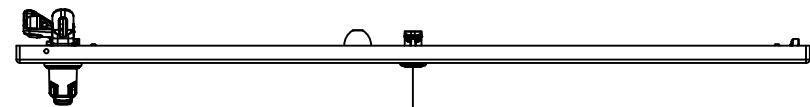

BOTTOM

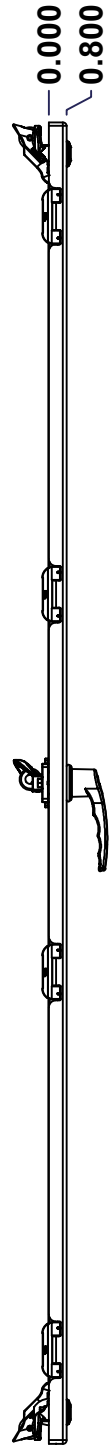

LEFT

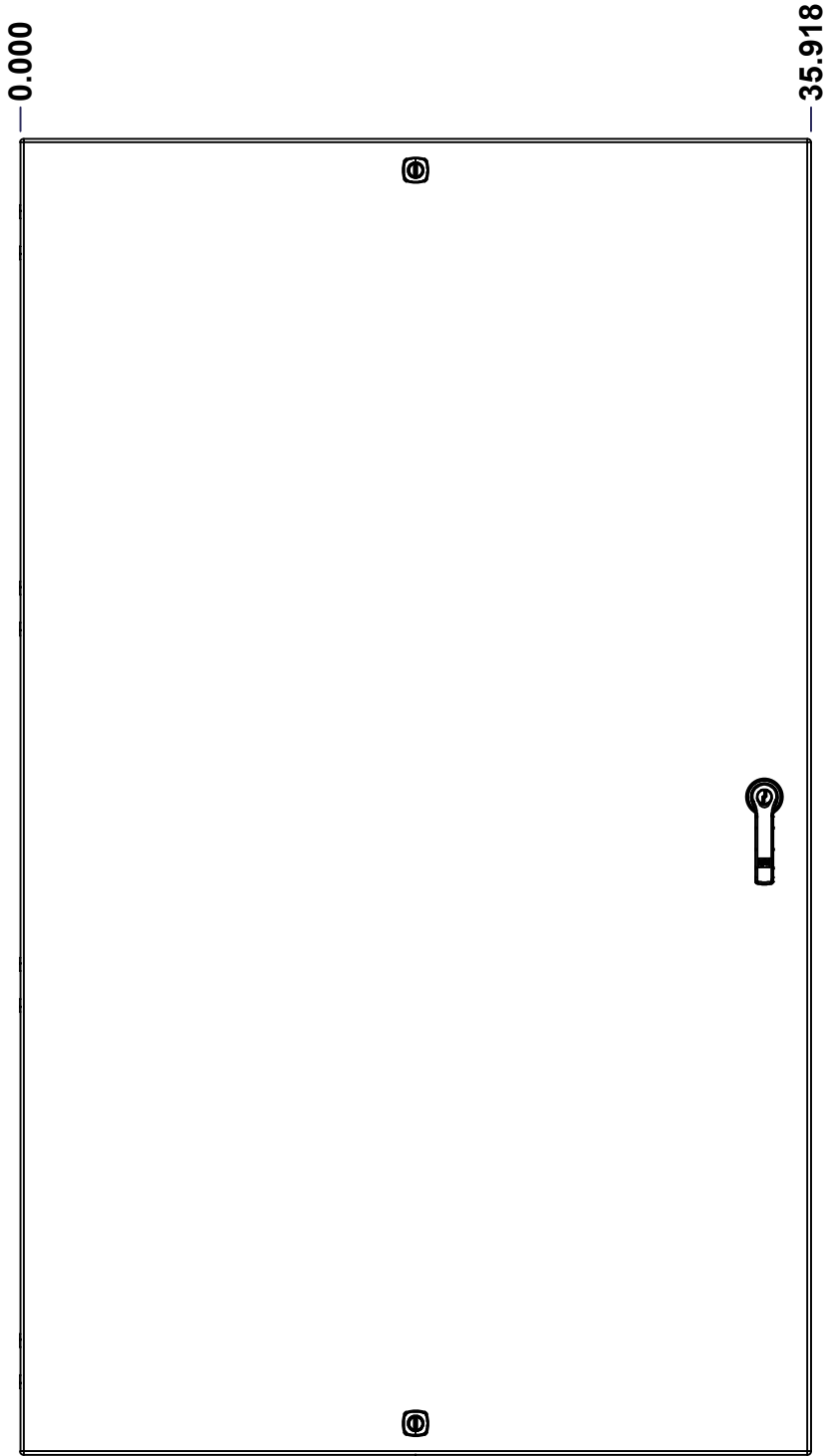

FRONT

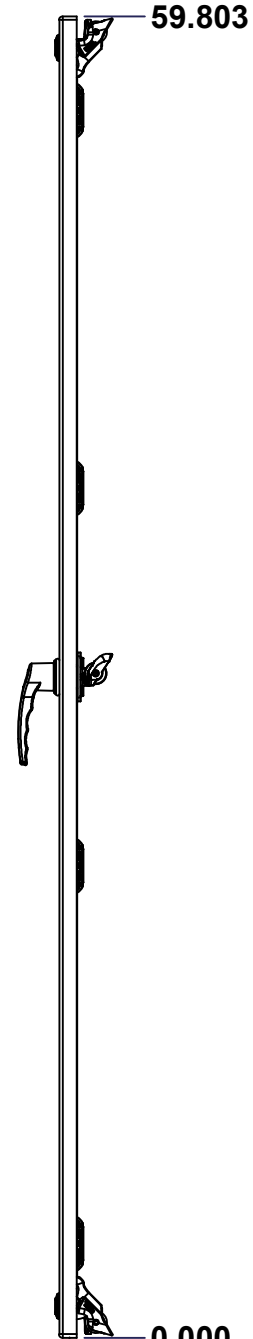

RIGHT

No.	Revisions	Date	By/Par

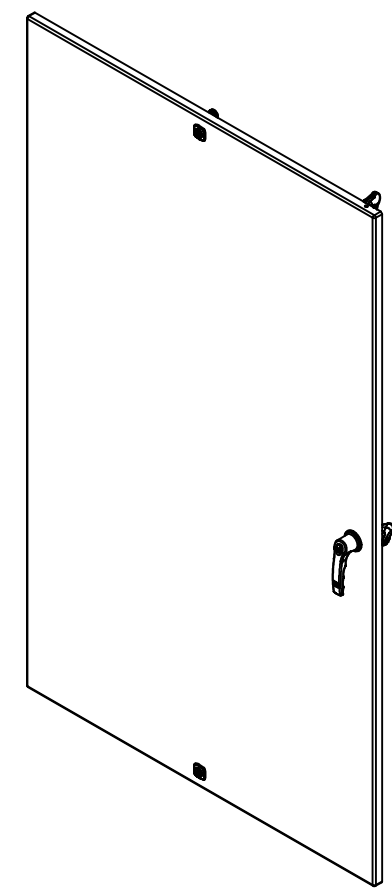

Isometric View



Tél: (450) 979-4373
 Fax: (450) 979-4626
www.exmweb.com

Flatness
 Aplatissement
 Max 3.0mm
 Projection

Customer Client	Date
Drawn By Dessiné Par BoxCad: BoxCad	Date 17-Apr-17

Material Matière 14 Ga Cold Rolled A1008 CS Type B (1.7mm)

Color Couleur Light Grey RAL7035
 Finish Fini Textured

Description 5412ES 60" x 36" Cover
 Detail Rev.

Part Number Numéro Pièce	Rev.	7
5412ESB603610C	0	9

SEE BILL OF MATERIAL ON LAST PAGE

This drawing is confidential and must not be reproduced or used without the consent of EXM

Ce dessin est confidentiel et ne doit pas être reproduit ou utilisé sans le consentement de EXM

STANDARD FEATURES ARE NOT LISTED IN THIS HOLE TABLE

HOLE TABLE - FRONT VIEW (CUSTOM FEATURE ONLY)

CUT-OUT	XDIM	YDIM	DESCRIPTION
1	1.486	1.850	STUD M6 x 18mm (Inside)
2	1.486	57.953	STUD M6 x 18mm (Inside)
3	32.423	57.953	STUD M6 x 18mm (Inside)
4	32.423	1.850	STUD M6 x 18mm (Inside)
5	1.486	29.902	STUD M6 x 18mm (Inside)
6	32.423	29.902	STUD M6 x 18mm (Inside)
7	33.803	54.896	CLOSING BAR STUD (Inside)
8	33.803	4.907	CLOSING BAR STUD (Inside)
9	20.459	1.435	STUD M6 x 18mm (Inside)

10	3.750	56.053	LABEL_EXM (Inside)
11	33.803	29.902	HANDLE 885 ESL2A @ 0.0°
12	17.959	58.379	LOCK 880 SCQ4-SL @ 90.0°
13	17.959	1.424	LOCK 880 SCQ4-SL @ 270.0°

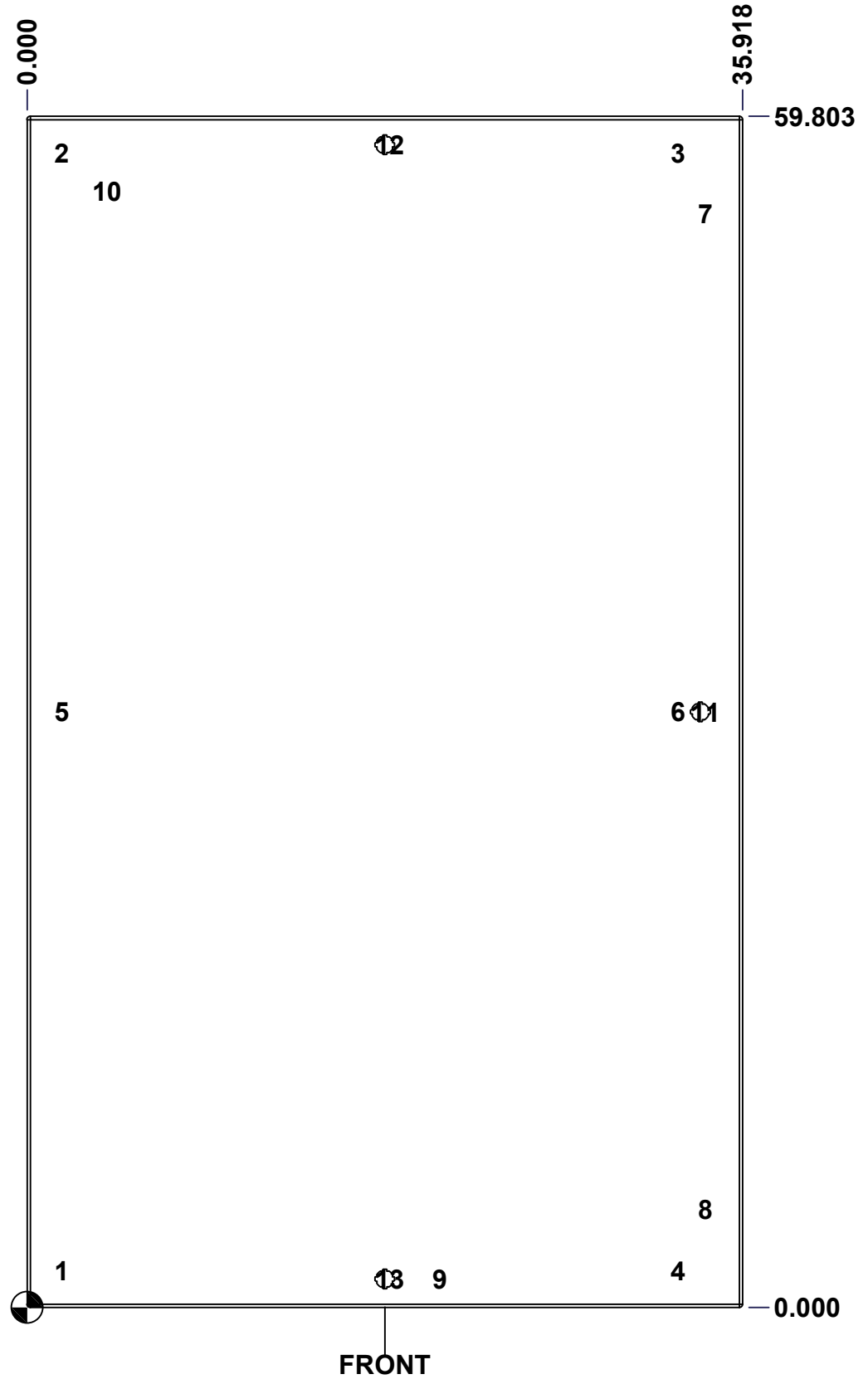

	Description	Status
	5412ES 60" x 36" Cover	(NULL)
	Part Number Numéro Pièce	Rev.
	5412ESB603610C	0 / 8 / 9

This drawing is confidential and must not be reproduced or used without the consent of EXM

Ce dessin est confidentiel et ne doit pas être reproduit ou utilisé sans le consentement de EXM

No.	Revisions	Date	By/Par

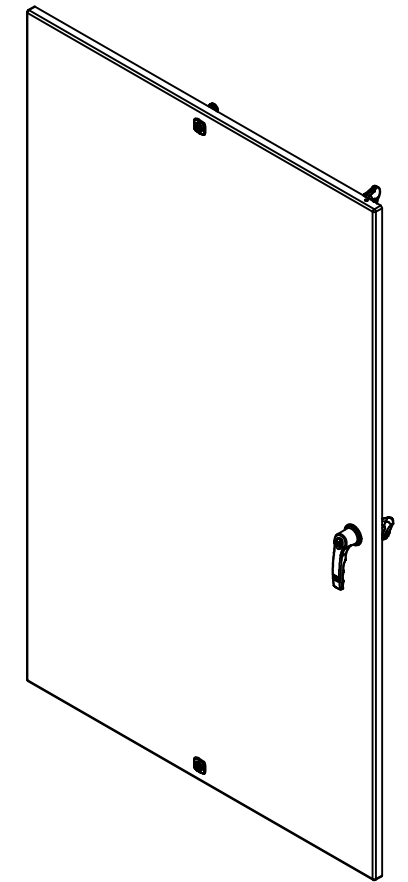

Isometric View



2	STK-K-12500	19	5412 ES 1/4 Turn Lock
2	STK-A-90042	5	5412 ES Cabinet Closing Bar End Assembly
2	STK-Q-45655-60	0	5412 ES - Closing Bar
1	STK-A-50536	15	5412 ES Handle Cam Assembly (Right Side, Grip 32mm)
1	STK-Q-90051	3	5412 ES - Handle Cam Spacer
1	885 ESL2A	4	5412 ES Key Lock L-Handle (3 Pts)
1	STK-S-00100	0	3.5" x 2" Silver Milar Flexcon Sticker
1	STK-P-03820R	0	Powder Paint (Light Grey / Rough Textured)
1	STK-Q-46515	3	5412 ES Door Support with Brass Insert
2	STK-Q-46020-60	5	5412 ES Vertical Door Stiffener 60"
2	STK-Q-16405	7	Guide Stud - Small (No Paint Cap Required)
7	STK-Q-16055	1	M6 x 18mm Stud (No Paint Cap Required)
1	5412ESB603610G	0	5412ES 60" x 36" Cover Gasket Part
1	5412ESB603610C-P	0	5412ES 60" x 36" Cover Part
4	STK-K-09800	10	5412 ES Hinge with 2 Captive Hinge Pins
6	STK-Q-07220	1	M6 Nylon Insert Lock Nut

QTY	Part Number	Rev	Description
Parts List			

Tél: (450) 979-4373 Fax: (450) 979-4626 www.exmweb.com	Flatness Aplatissement	Max 3.0mm
	Projection	
Customer Client	Date	
Drawn By Dessiné Par	BoxCad: BoxCad	Date 17-Apr-17
Material Matière	14 Ga Cold Rolled A1008 CS Type B (1.7mm)	
Color Couleur	Light Grey RAL7035	Finish Fini Textured
Description	5412ES 60" x 36" Cover	
Part Number Numéro Pièce	Rev.	9
5412ESB603610C	0	9

This drawing is confidential and must not be reproduced or used without the consent of EXM

Ce dessin est confidentiel et ne doit pas être reproduit ou utilisé sans le consentement de EXM

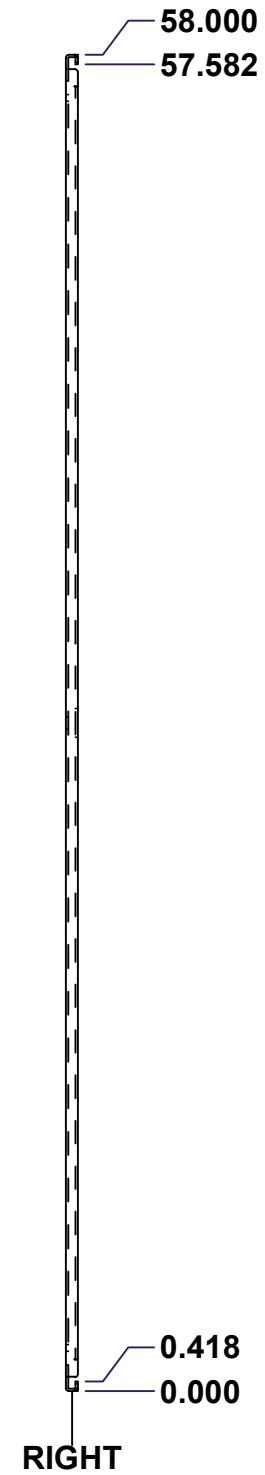
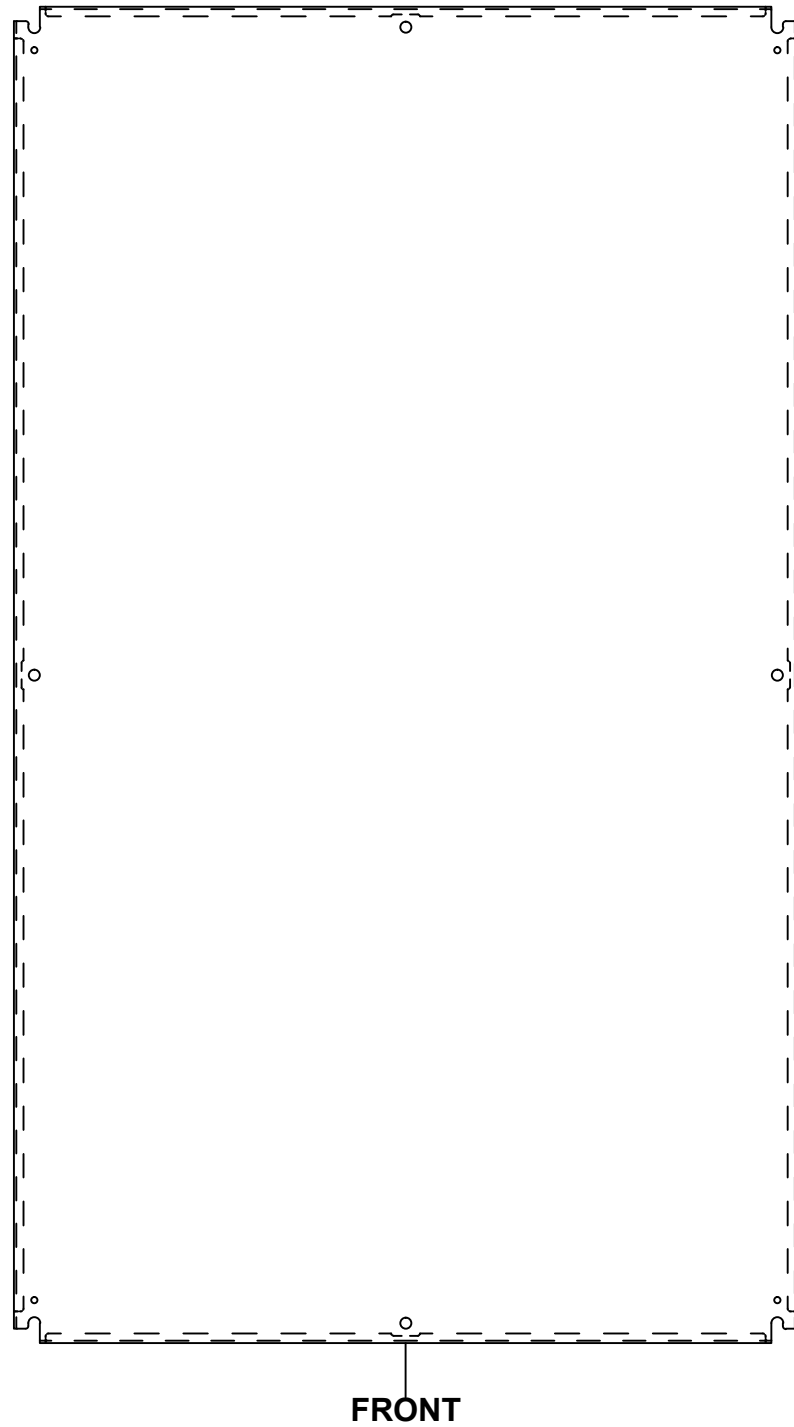
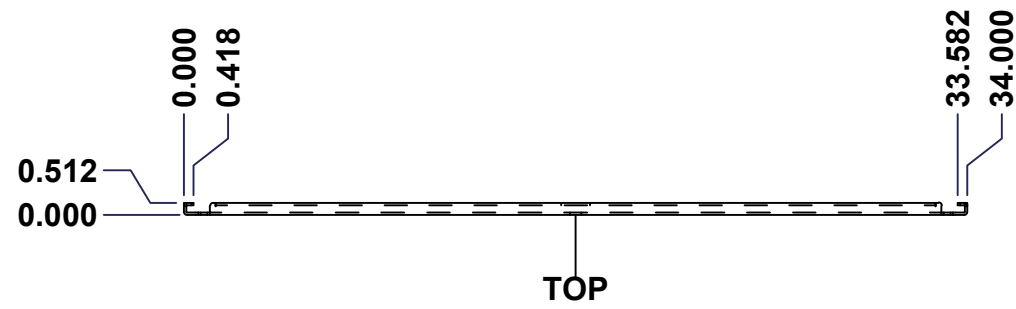

No.	Revisions	Date	By/Par

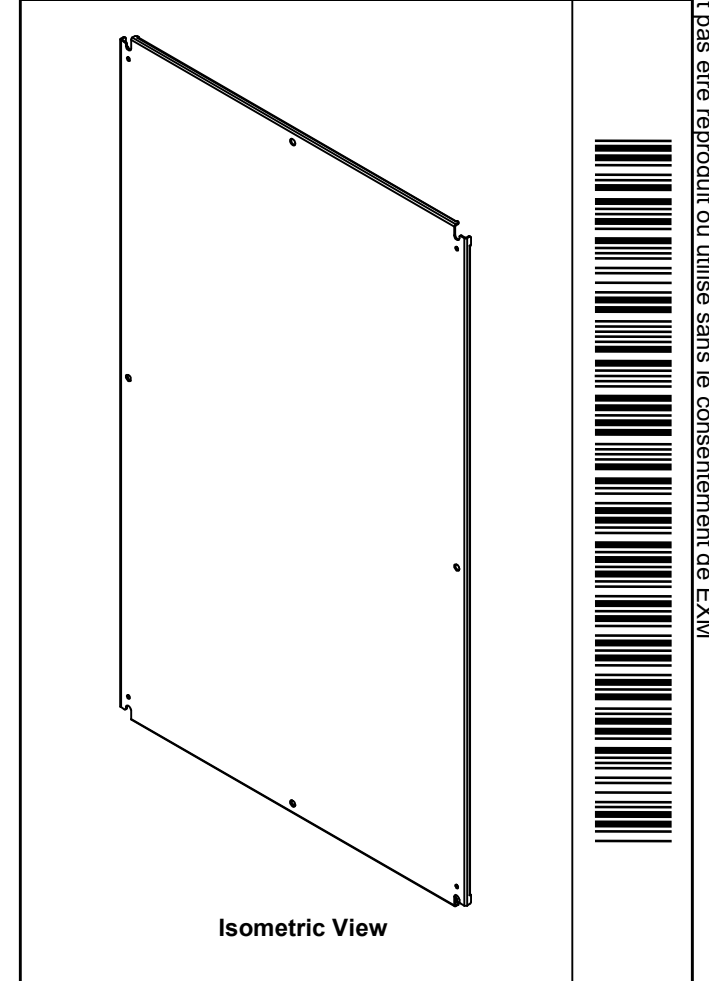

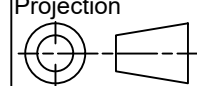
 Tél: (450) 979-4373 Fax: (450) 979-4626 www.exmweb.com		Flatness Aplatissement Max 3.0mm Projection 
Customer Client	Date	
Drawn By Dessiné Par: BoxCad	Date: 23-Jan-07	
Material Matière	See Part List	
Color Couleur	See Part List	Finish Fini: See Part List
Description	Detail Rev.	
881 SP - Inner Panel		
Part Number Numéro Pièce: 881 SP6036G	Rev. 0	1 2

Qty	Part Number	Rev	Description	Material	Color	Finish
1	881 SP6036G-P	0	881 SP - Inner Panel Part	12 Ga Galvanized	Unpainted	Galvanized

Parts List

This drawing is confidential and must not be reproduced or used without the consent of EXM

Ce dessin est confidentiel et ne doit pas être reproduit ou utilisé sans le consentement de EXM

Table 1			FRONT VIEW
CUT-OUT	XDIM	YDIM	DESCRIPTION
1	17.000	0.875	MTG STUD HOLE (RND Ø0.500)
2	0.875	29.000	MTG STUD HOLE (RND Ø0.500)
3	33.125	29.000	MTG STUD HOLE (RND Ø0.500)
4	17.000	57.125	MTG STUD HOLE (RND Ø0.500)
5	0.875	1.875	GROUND HOLE (RND Ø0.290)
6	33.125	1.875	GROUND HOLE (RND Ø0.290)
7	0.875	56.125	GROUND HOLE (RND Ø0.290)
8	33.125	56.125	GROUND HOLE (RND Ø0.290)

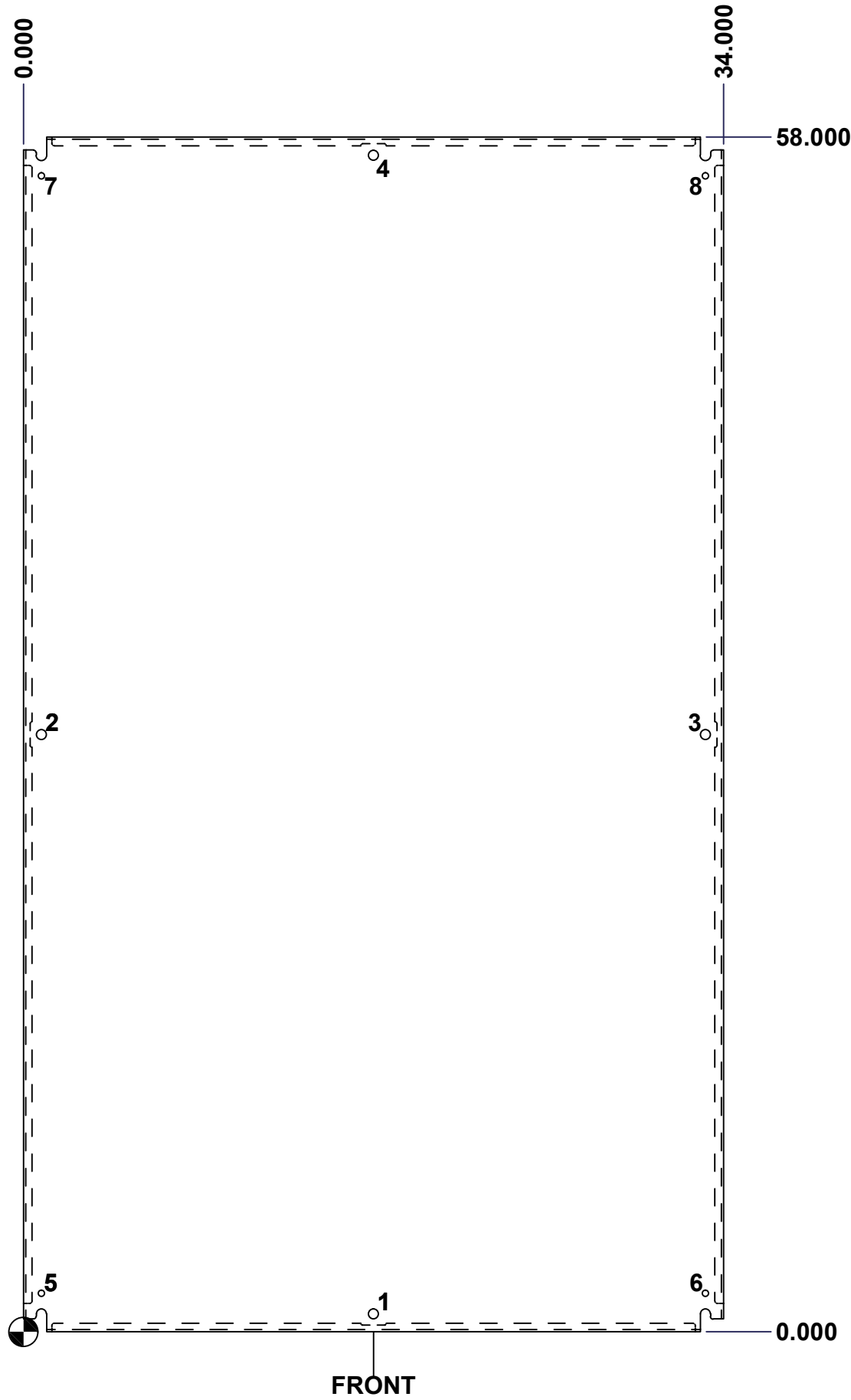

All knockouts are actual size / Les disques défonçables sont grandeur réel

No.	Revisions	Date	By/Par

Isometric View

		Tél: (450) 979-4373 Fax: (450) 979-4626 www.exmweb.com		Flatness Aplatissement Max 3.0mm	
Customer Client		Date		Projection 	
Drawn By Dessiné Par BoxCad		Date 23-Jan-07		Material Matière See Part List	
Color Couleur See Part List		Finish Fini See Part List		Description 881 SP - Inner Panel	
Part Number Numéro Pièce 881 SP6036G		Rev. 0		Detail Rev. 2	