

This drawing is confidential and must not be reproduced or used without the consent of EXM

Ce dessin est confidentiel et ne doit pas être reproduit ou utilisé sans le consentement de EXM

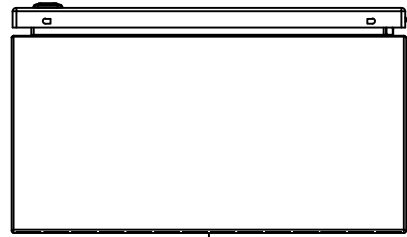

TOP

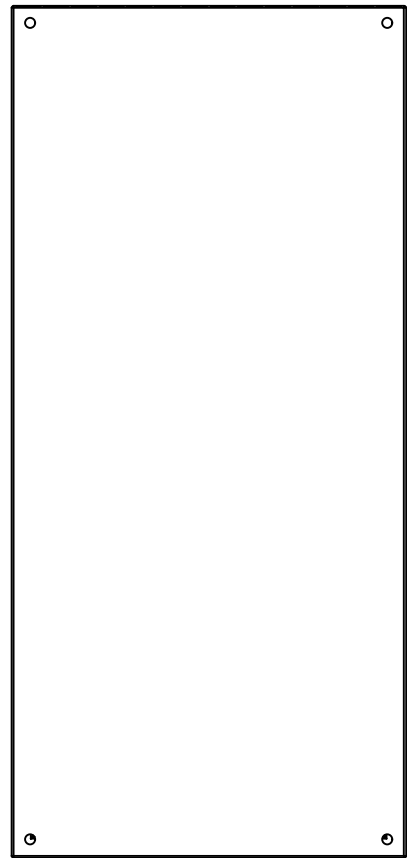

BACK

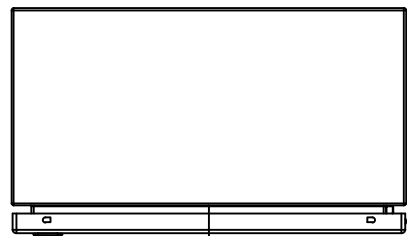

BOTTOM

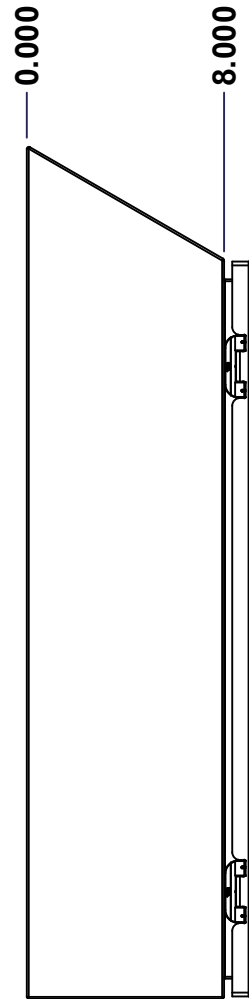

LEFT

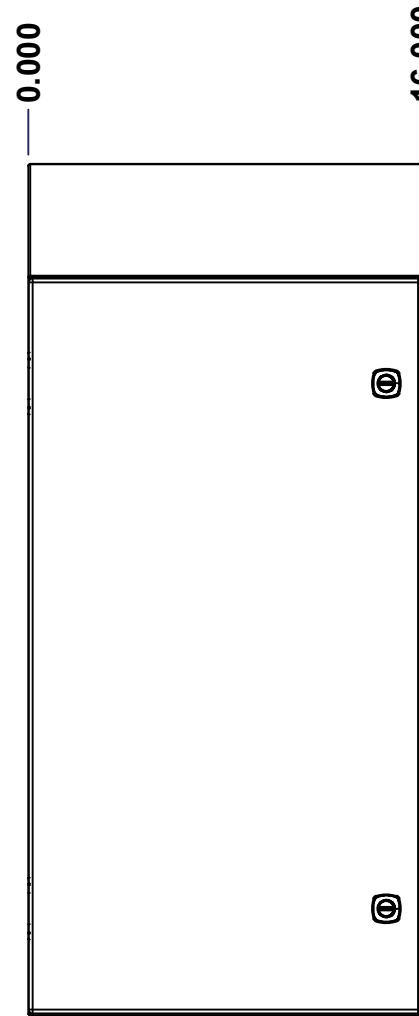

FRONT

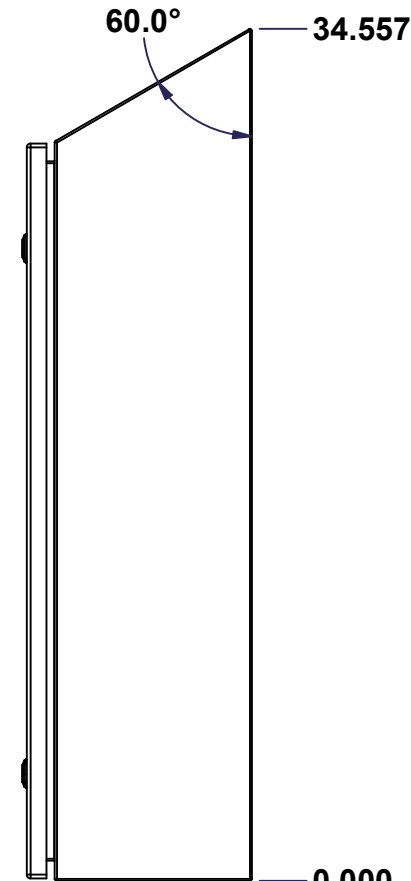

RIGHT

No.	Revisions	Date	By/Par

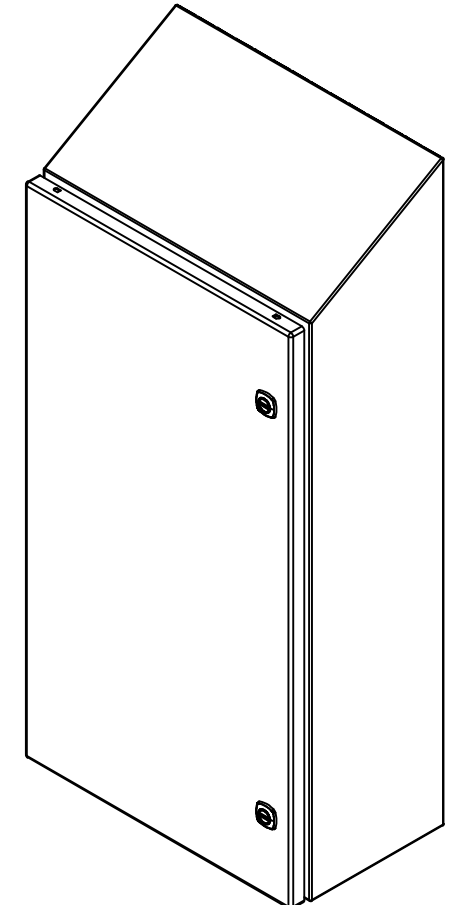

Isometric View

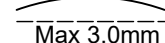
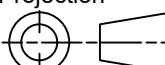

 Tél: (450) 979-4373 Fax: (450) 979-4626 <a href="http://www.exmweb.com">www.exmweb.com</a>		Flatness Aplatissement  Max 3.0mm Projection 
Customer Client	Date	
Drawn By Dessiné Par	BoxCad: BoxCad	Date 10-Sep-25
Material Matière	16 Ga Cold Rolled A1008 CS Type B (1.4mm)	
Color Couleur	Asa-61 Grey	Finish Fini Textured
Description	Detail Rev.	
5412ESCSF 30" x 16" x 8" Assembly		
Part Number Numéro Pièce	Rev.	1
5412ESCSF301608	0	9

SEE BILL OF MATERIAL ON LAST PAGE

This drawing is confidential and must not be reproduced or used without the consent of EXM

Ce dessin est confidentiel et ne doit pas être reproduit ou utilisé sans le consentement de EXM

NOTE	
ITEM	DESCRIPTION
1	NEMA 4, 12 Enclosure (IP66)
2	C/W Standard ground studs on box and cover
3	W/O Standard door stiffener
4	C/W Standard inner panel (Included)
5	C/W Standard inner panel mounting studs

No.	Revisions	Date	By/Par

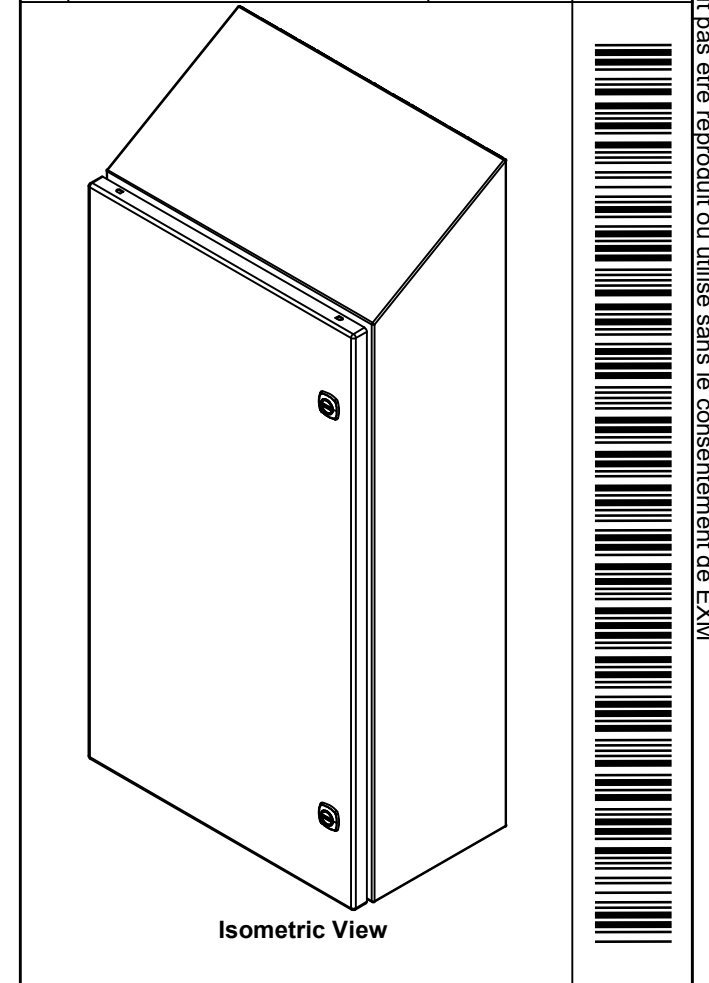

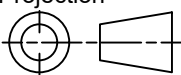
 Tél: (450) 979-4373 Fax: (450) 979-4626 <a href="http://www.exmweb.com">www.exmweb.com</a>	Flatness Aplatissement
	Max 3.0mm
Projection	
Customer Client	Date
Drawn By Dessiné Par BoxCad: BoxCad	Date 10-Sep-25
Material Matière 16 Ga Cold Rolled A1008 CS Type B (1.4mm)	

PACKING		
ITEM	QTY	DESCRIPTION
Cardboard sleeve	2	Top and Bottom
Cardboard strip	2	Between back of enclosure and inner panel
Plastic bag	1	To protect cover surface and inside gasket
Plastic strap - Black	2	To Squeeze the 2 cardboard sleeve together
Packaging label	1	White label with product number

1	881 SP3016G	0	881 SP - Inner Panel
2	STK-K-01320	0	5412 ES Inner Panel Accessory Kit
1	STK-K-01800	5	5412 ES Accessory Kit
1	5412ESCSF301608C	0	5412ESCSF 30" x 16" Cover
1	5412ESCSF301608B	0	5412ESCSF 30" x 16" x 8" Body
2	STK-Q-04050-08	0	M6 x 8mm Hexagon Socket Head Machine Screw
Qty	Part Number	Rev	Description
Parts List			

Color Couleur	Asa-61 Grey	Finish Fini	Textured
Description	5412ESCSF 30" x 16" x 8" Assembly		Detail Rev.
Part Number Numéro Pièce	<b>5412ESCSF301608</b>		Rev. 2
			0
			9

This drawing is confidential and must not be reproduced or used without the consent of EXM

Ce dessin est confidentiel et ne doit pas être reproduit ou utilisé sans le consentement de EXM

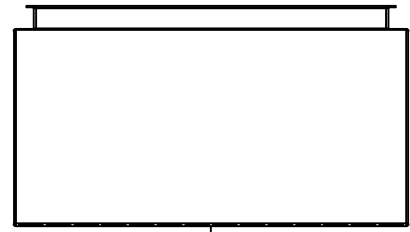

TOP

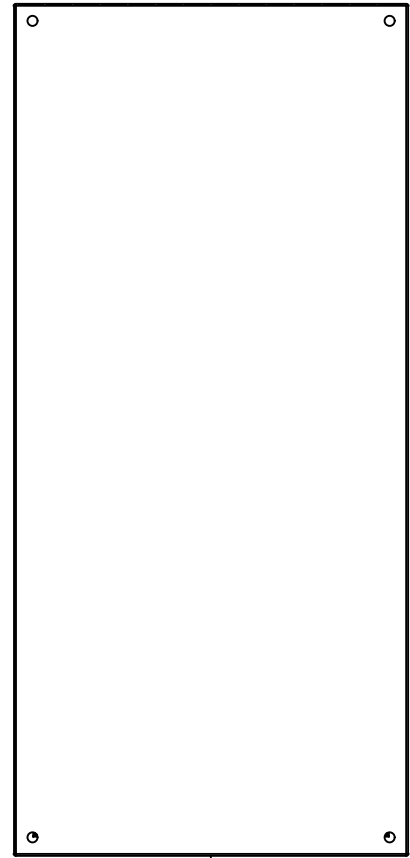

BACK

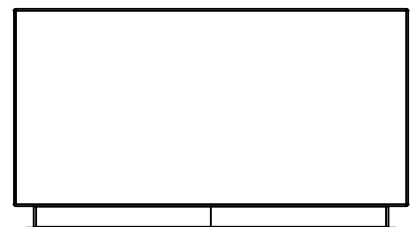

BOTTOM

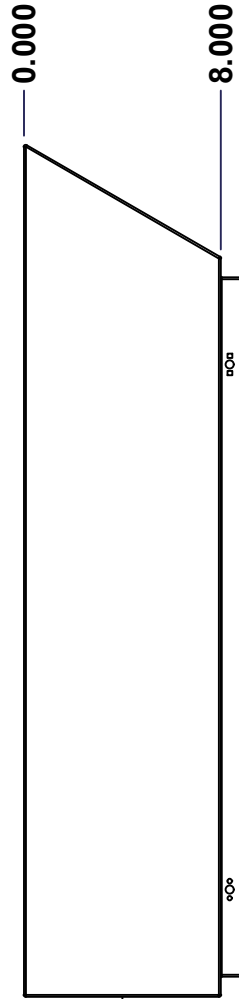

LEFT

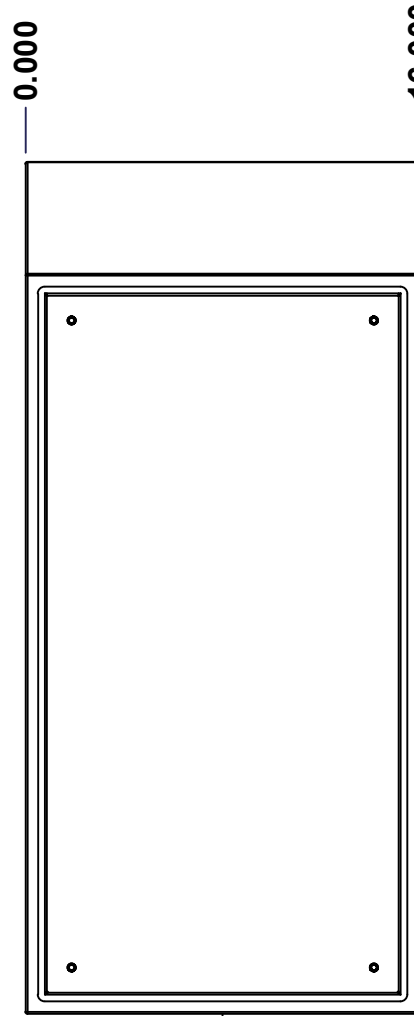

FRONT

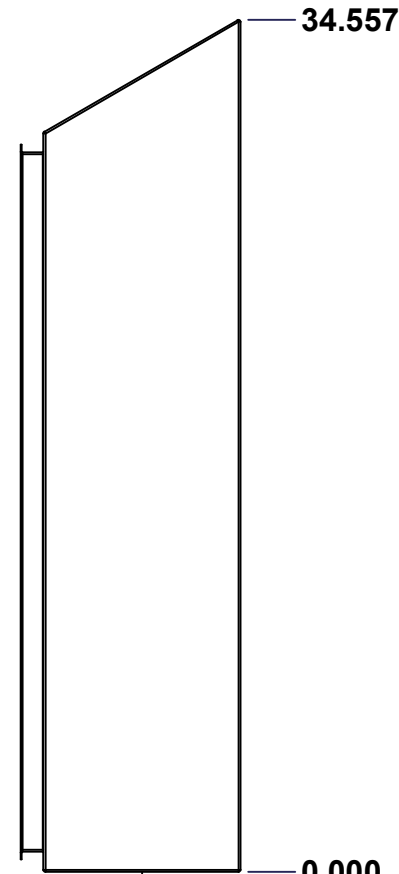

RIGHT

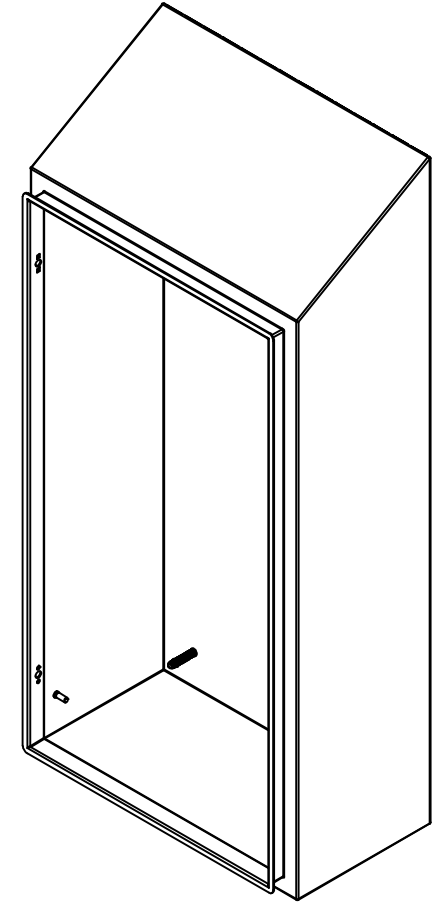

Isometric View

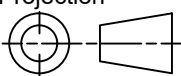

No.	Revisions	Date	By/Par

 Tél: (450) 979-4373 Fax: (450) 979-4626 <a href="http://www.exmweb.com">www.exmweb.com</a>		Flatness Aplatissement Max 3.0mm Projection 
Customer Client	Date	
Drawn By Dessiné Par	BoxCad: BoxCad	Date 10-Sep-25
Material Matière	16 Ga Cold Rolled A1008 CS Type B (1.4mm)	
Color Couleur	Asa-61 Grey	Finish Fini Textured
Description	Detail Rev.	
5412ESCSF 30" x 16" x 8" Body		
Part Number Numéro Pièce	Rev.	3
5412ESCSF301608B	0	9

SEE BILL OF MATERIAL ON LAST PAGE

This drawing is confidential and must not be reproduced or used without the consent of EXM

Ce dessin est confidentiel et ne doit pas être reproduit ou utilisé sans le consentement de EXM

<b>STANDARD FEATURES ARE NOT LISTED IN THIS HOLE TABLE</b>			
<b>HOLE TABLE - LEFT VIEW (CUSTOM FEATURE ONLY)</b>			
CUT-OUT	XDIM	YDIM	DESCRIPTION
1	6.500	2.000	GND STUD M6 x 16mm (Inside)

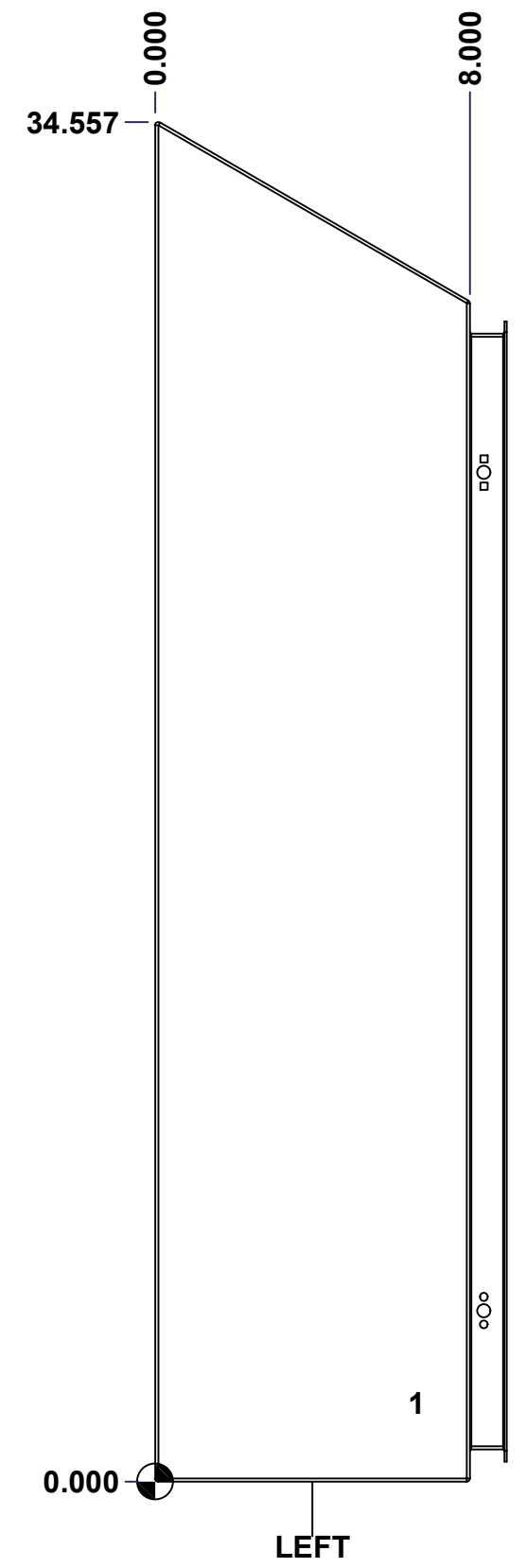

	Description	Status	
	5412ESCSF 30" x 16" x 8" Body	(NULL)	
	Part Number Numéro Pièce	Rev.	
	<b>5412ESCSF301608B</b>	<b>0</b>	4/9

This drawing is confidential and must not be reproduced or used without the consent of EXM

Ce dessin est confidentiel et ne doit pas être reproduit ou utilisé sans le consentement de EXM

**STANDARD FEATURES ARE NOT LISTED IN THIS HOLE TABLE**

**HOLE TABLE - BACK VIEW (CUSTOM FEATURE ONLY)**

CUT-OUT	XDIM	YDIM	DESCRIPTION
1	1.875	1.875	IP STUD M8 x 35mm (Inside)
2	1.875	28.125	IP STUD M8 x 35mm (Inside)
3	14.125	28.125	IP STUD M8 x 35mm (Inside)
4	14.125	1.875	IP STUD M8 x 35mm (Inside)
-----			
5	15.250	0.750	RND Ø0.390
6	15.250	33.869	RND Ø0.390
7	0.750	33.869	RND Ø0.390
8	0.750	0.750	RND Ø0.390

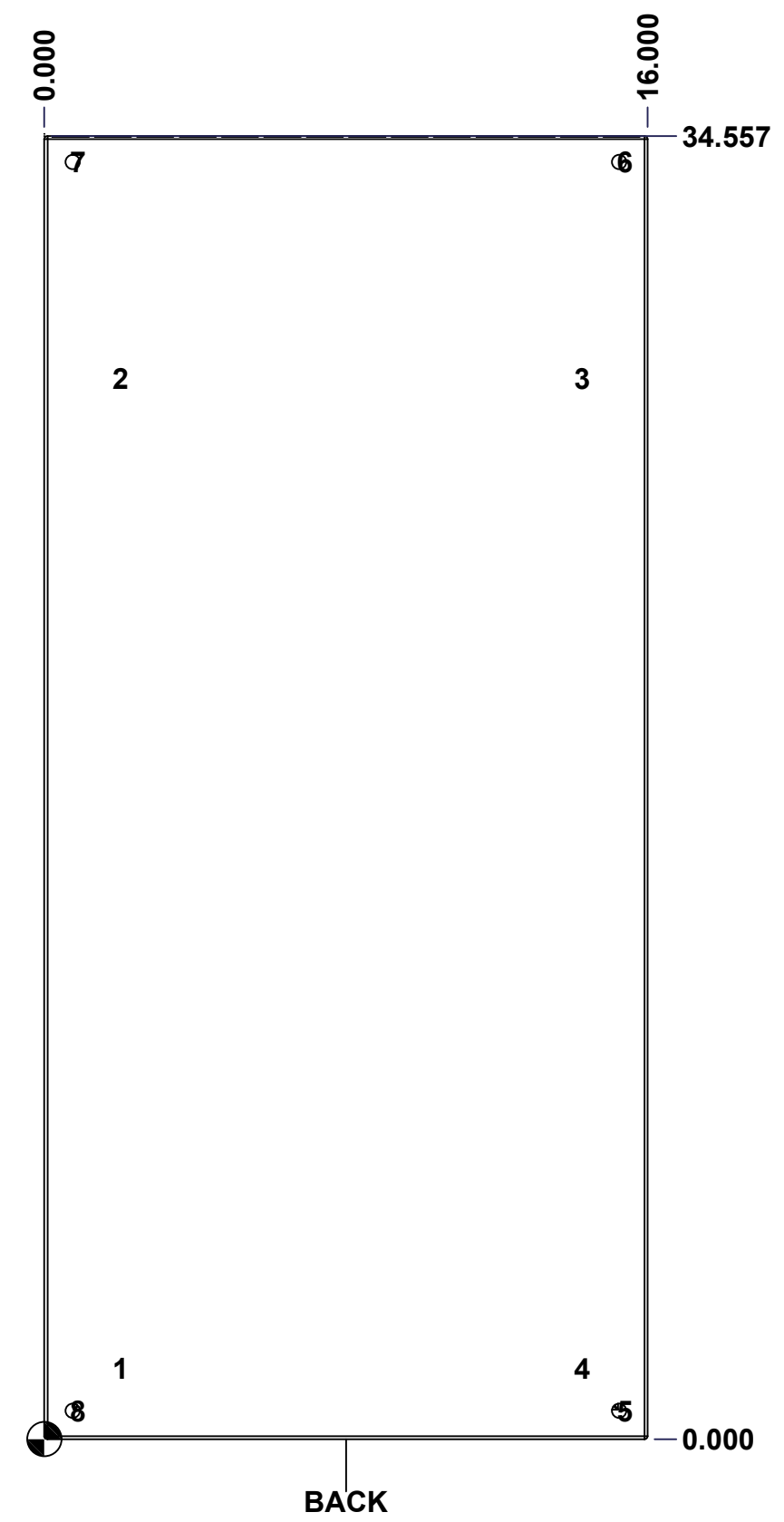

	Description	Status
	5412ESCSF 30" x 16" x 8" Body	(NULL)
Part Number Numéro Pièce <b>5412ESCSF301608B</b>	Rev.	5
	<b>0</b>	9

This drawing is confidential and must not be reproduced or used without the consent of EXM

Ce dessin est confidentiel et ne doit pas être reproduit ou utilisé sans le consentement de EXM

No.	Revisions	Date	By/Par

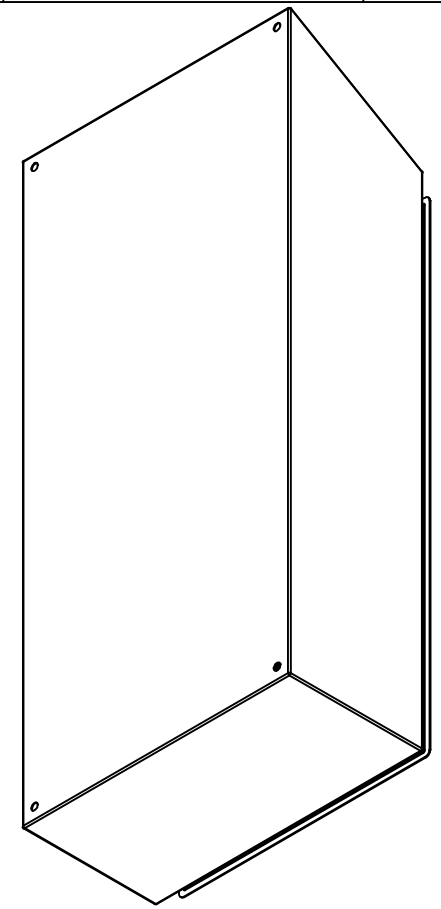

Isometric View

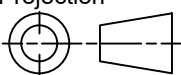

 Tél: (450) 979-4373 Fax: (450) 979-4626 <a href="http://www.exmweb.com">www.exmweb.com</a>		Flatness Aplatissement Max 3.0mm Projection 
Customer Client	Date	
Drawn By Dessiné Par	BoxCad: BoxCad	Date 10-Sep-25
Material Matière	16 Ga Cold Rolled A1008 CS Type B (1.4mm)	
Color Couleur	Asa-61 Grey	Finish Fini Textured
Description		Detail Rev.
5412ESCSF 30" x 16" x 8" Body		
Part Number Numéro Pièce	Rev.	6
<b>5412ESCSF301608B</b>	<b>0</b>	9

Qty	Part Number	Rev	Description
1	STK-Q-16080	0	Ground Stud M6 x 16mm Steel
1	STK-P-02400R	0	Powder Paint (Asa-61 Grey / Rough Textured)
4	STK-Q-16005	1	Stud M8 x 35mm (No Paint Cap Required)
1	5412ESCSF301608B-P	0	5412ESCSF 30" x 16" x 8" Body Part
Parts List			

This drawing is confidential and must not be reproduced or used without the consent of EXM

Ce dessin est confidentiel et ne doit pas être reproduit ou utilisé sans le consentement de EXM

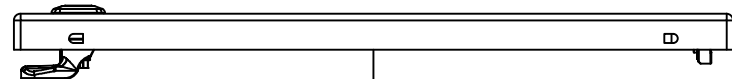

TOP

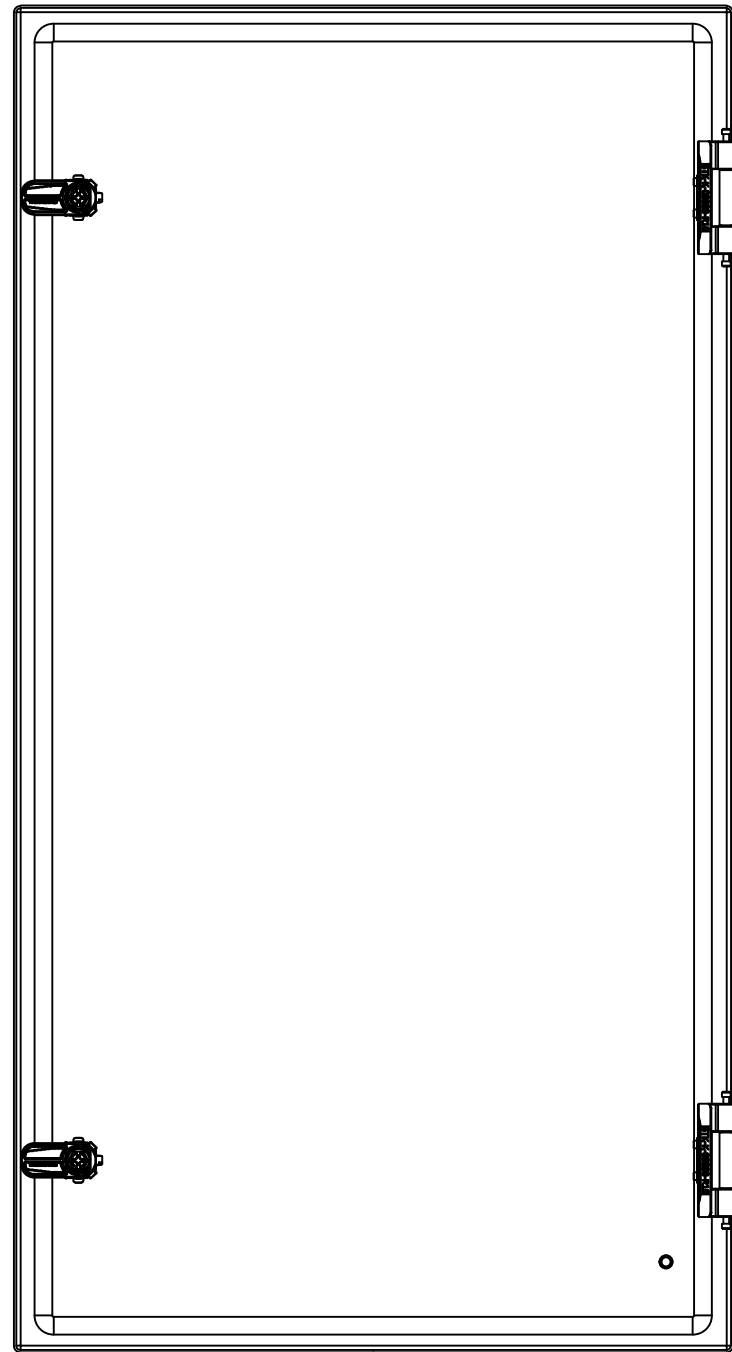

BACK

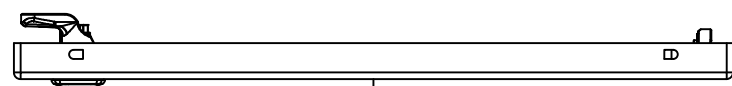

BOTTOM

0.000  
0.800

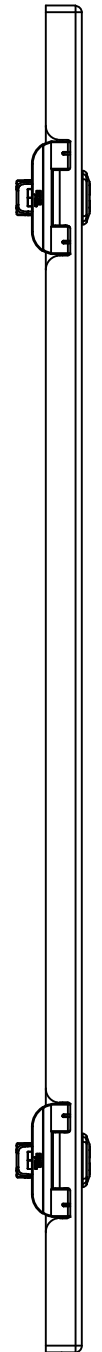

LEFT

0.000

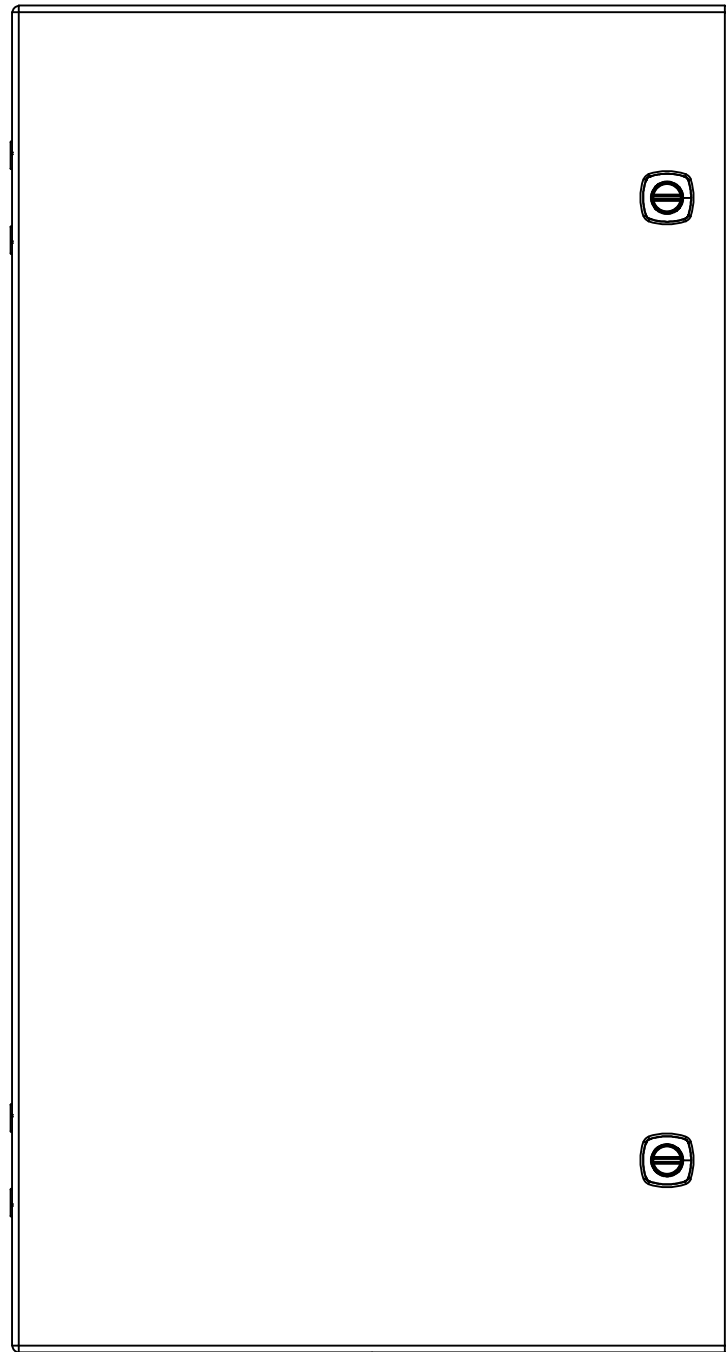

FRONT

15.918

29.803

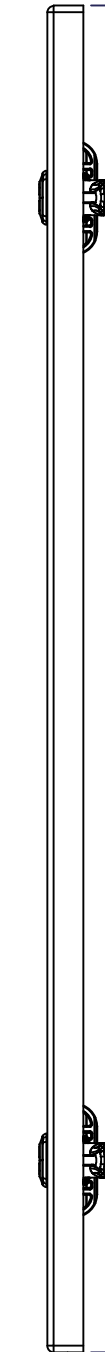

RIGHT

0.000

No.	Revisions	Date	By/Par

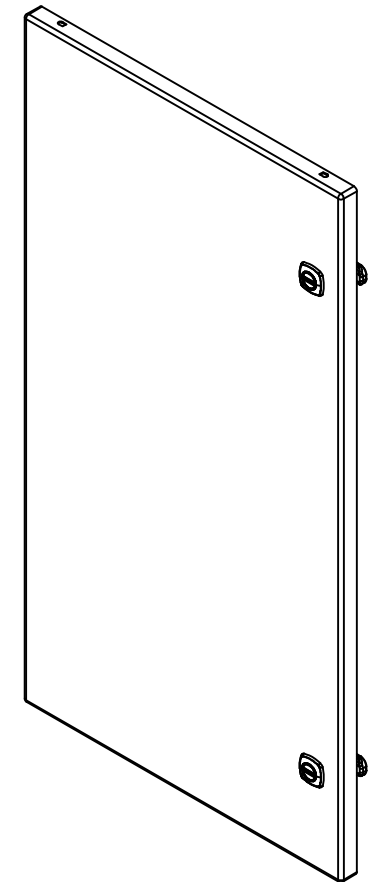

Isometric View



Tél: (450) 979-4373  
Fax: (450) 979-4626  
[www.exmweb.com](http://www.exmweb.com)

Flatness  
Aplatissement

Max 3.0mm

Projection

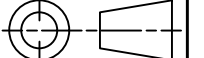

Customer Client \_\_\_\_\_ Date \_\_\_\_\_

Drawn By Dessiné Par BoxCad: BoxCad Date 10-Sep-25

Material Matière 16 Ga Cold Rolled A1008 CS Type B (1.4mm)

Color Couleur Asa-61 Grey Finish Fini Textured

Description 5412ESCSF 30" x 16" Cover Detail Rev. \_\_\_\_\_

Part Number Numéro Pièce **5412ESCSF301608C** Rev. **0** 7/9

SEE BILL OF MATERIAL ON LAST PAGE

This drawing is confidential and must not be reproduced or used without the consent of EXM

Ce dessin est confidentiel et ne doit pas être reproduit ou utilisé sans le consentement de EXM

**STANDARD FEATURES ARE NOT LISTED IN THIS HOLE TABLE**

**HOLE TABLE - FRONT VIEW (CUSTOM FEATURE ONLY)**

CUT-OUT	XDIM	YDIM	DESCRIPTION
1	1.486	2.000	GND STUD M6 x 16mm (Inside)
2	14.494	25.553	LOCK 880 SCQ4-SL @ 0.0°
3	14.494	4.250	LOCK 880 SCQ4-SL @ 0.0°

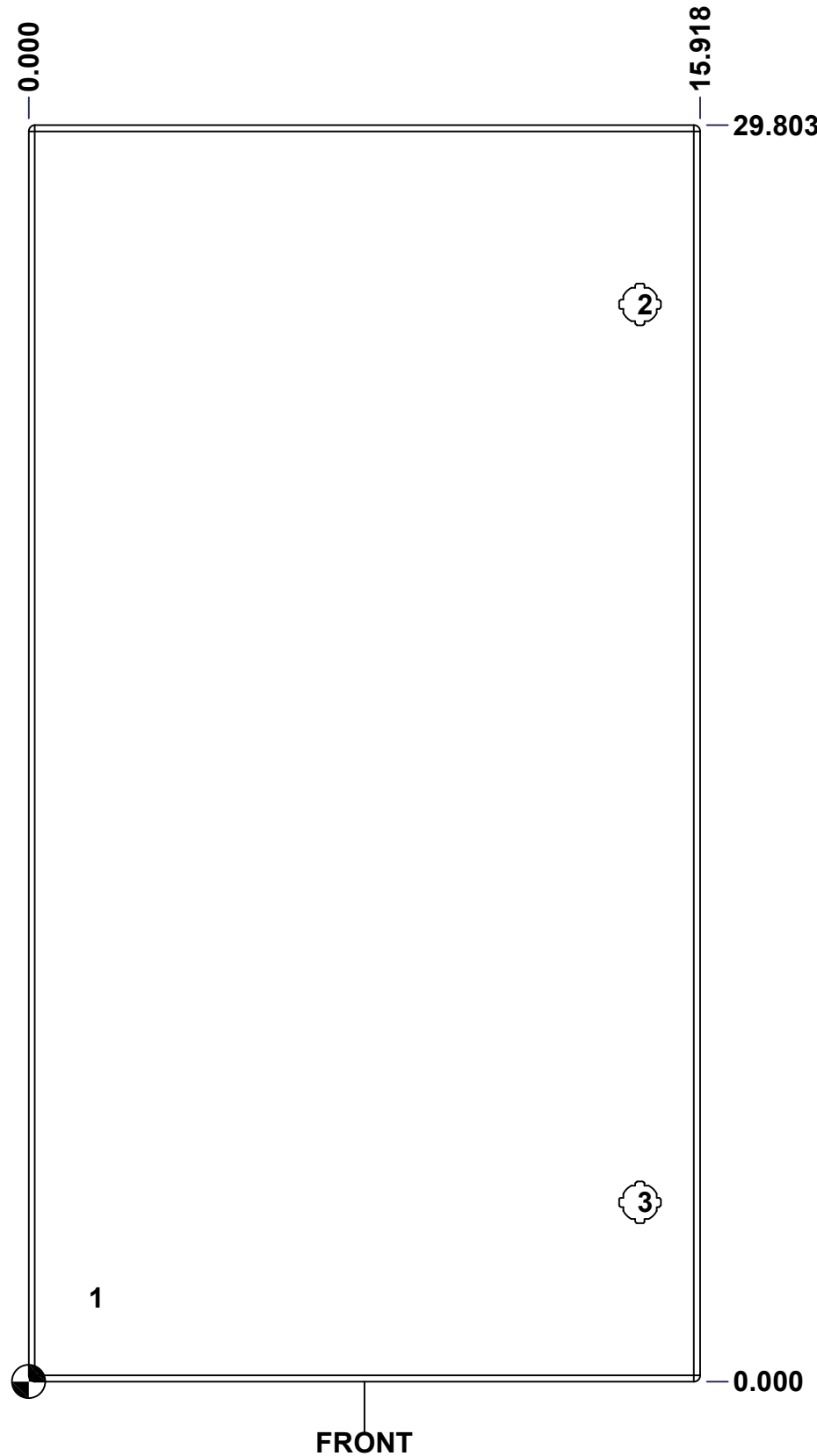

	Description	Status
	5412ESCSF 30" x 16" Cover	(NULL)
Part Number Numéro Pièce <b>5412ESCSF301608C</b>	Rev.	8
	<b>0</b>	9

This drawing is confidential and must not be reproduced or used without the consent of EXM

Ce dessin est confidentiel et ne doit pas être reproduit ou utilisé sans le consentement de EXM

No.	Revisions	Date	By/Par

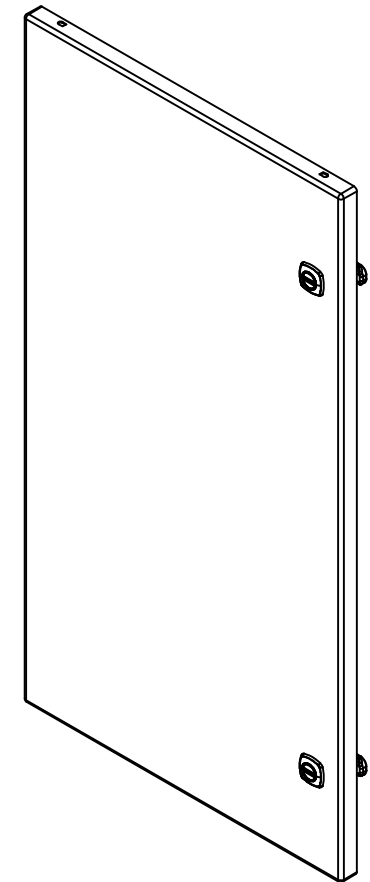

Isometric View

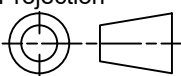

 Tél: (450) 979-4373 Fax: (450) 979-4626 <a href="http://www.exmweb.com">www.exmweb.com</a>	Flatness Aplatissement	Max 3.0mm
	Projection	
Customer Client	Date	
Drawn By Dessiné Par	BoxCad: BoxCad	Date 10-Sep-25
Material Matière	16 Ga Cold Rolled A1008 CS Type B (1.4mm)	
Color Couleur	Asa-61 Grey	Finish Fini Textured
Description	Detail Rev.	
5412ESCSF 30" x 16" Cover		
Part Number Numéro Pièce	Rev.	9
<b>5412ESCSF301608C</b>	<b>0</b>	<b>9</b>

QTY	Part Number	Rev	Description
2	STK-K-12500	19	5412 ES 1/4 Turn Lock
1	STK-Q-16080	0	Ground Stud M6 x 16mm Steel
1	STK-P-02400R	0	Powder Paint (Asa-61 Grey / Rough Textured)
1	5412ESCSF301608G	0	5412ESCSF 30" x 16" Cover Gasket Part
1	5412ESCSF301608C-P	0	5412ESCSF 30" x 16" Cover Part
2	STK-K-09800	10	5412 ES Hinge with 2 Captive Hinge Pins
Parts List			

This drawing is confidential and must not be reproduced or used without the consent of EXM

Ce dessin est confidentiel et ne doit pas être reproduit ou utilisé sans le consentement de EXM

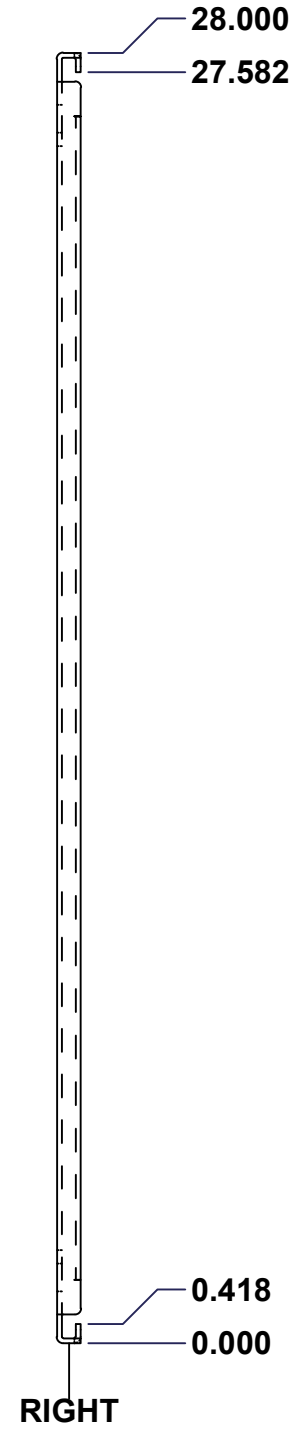
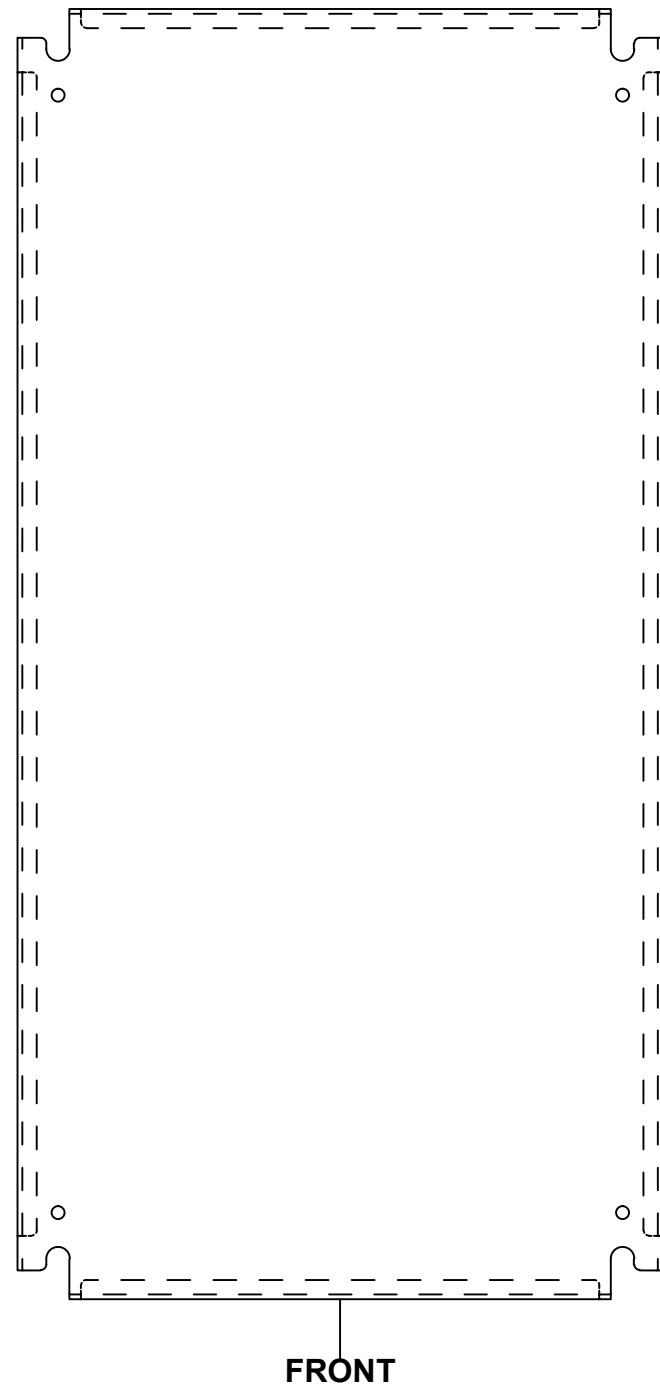
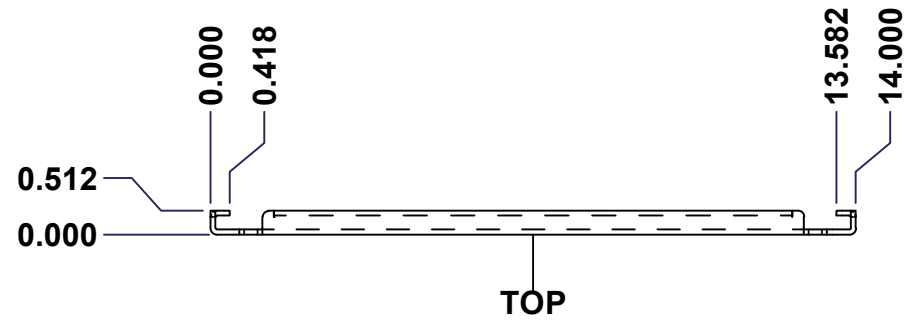

No.	Revisions	Date	By/Par

**Isometric View**

Tél: (450) 979-4373 Fax: (450) 979-4626 www.exmweb.com		Flatness Aplatissement Max 3.0mm Projection 
Customer Client	Date	
Drawn By / Dessiné Par: BoxCad	Date: 23-Jan-07	
Material / Matière	See Part List	
Color / Couleur: See Part List	Finish / Fini: See Part List	
Description: 881 SP - Inner Panel		Detail Rev.
Part Number / Numéro Pièce: <b>881 SP3016G</b>	Rev.:	1 / 2

Qty	Part Number	Rev	Description	Material	Color	Finish
1	881 SP3016G-P	0	881 SP - Inner Panel Part	12 Ga Galvanized	Unpainted	Galvanized

Parts List

This drawing is confidential and must not be reproduced or used without the consent of EXM

Ce dessin est confidentiel et ne doit pas être reproduit ou utilisé sans le consentement de EXM

Table 1			FRONT VIEW
CUT-OUT	XDIM	YDIM	DESCRIPTION
1	0.875	1.875	GROUND HOLE (RND Ø0.290)
2	13.125	1.875	GROUND HOLE (RND Ø0.290)
3	0.875	26.125	GROUND HOLE (RND Ø0.290)
4	13.125	26.125	GROUND HOLE (RND Ø0.290)

All knockouts are actual size / Les disques défonçables sont grandeur réel

No.	Revisions	Date	By/Par

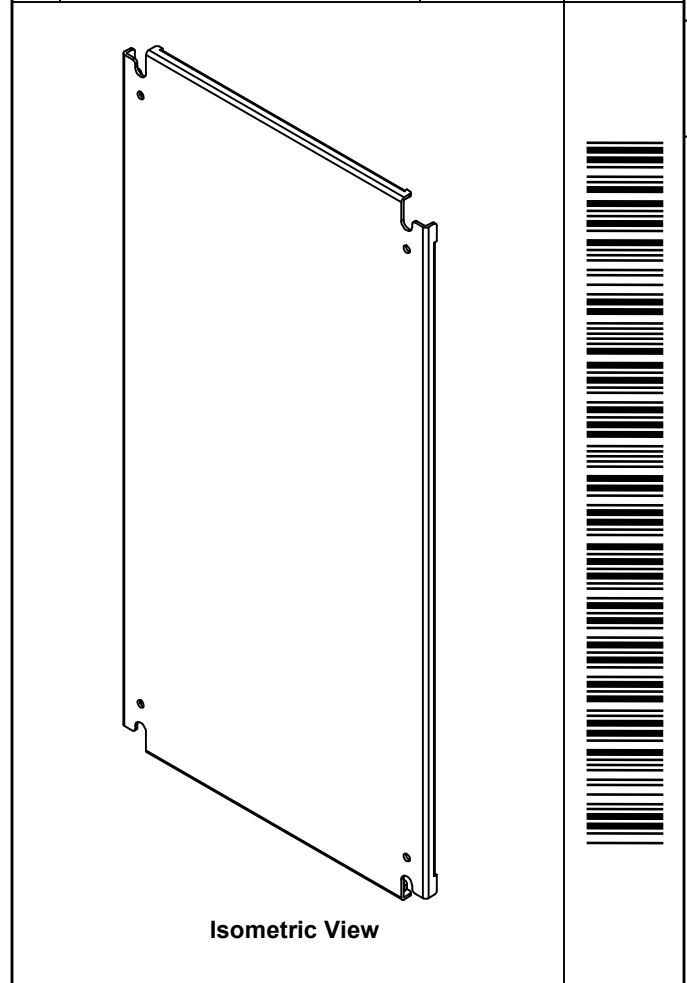
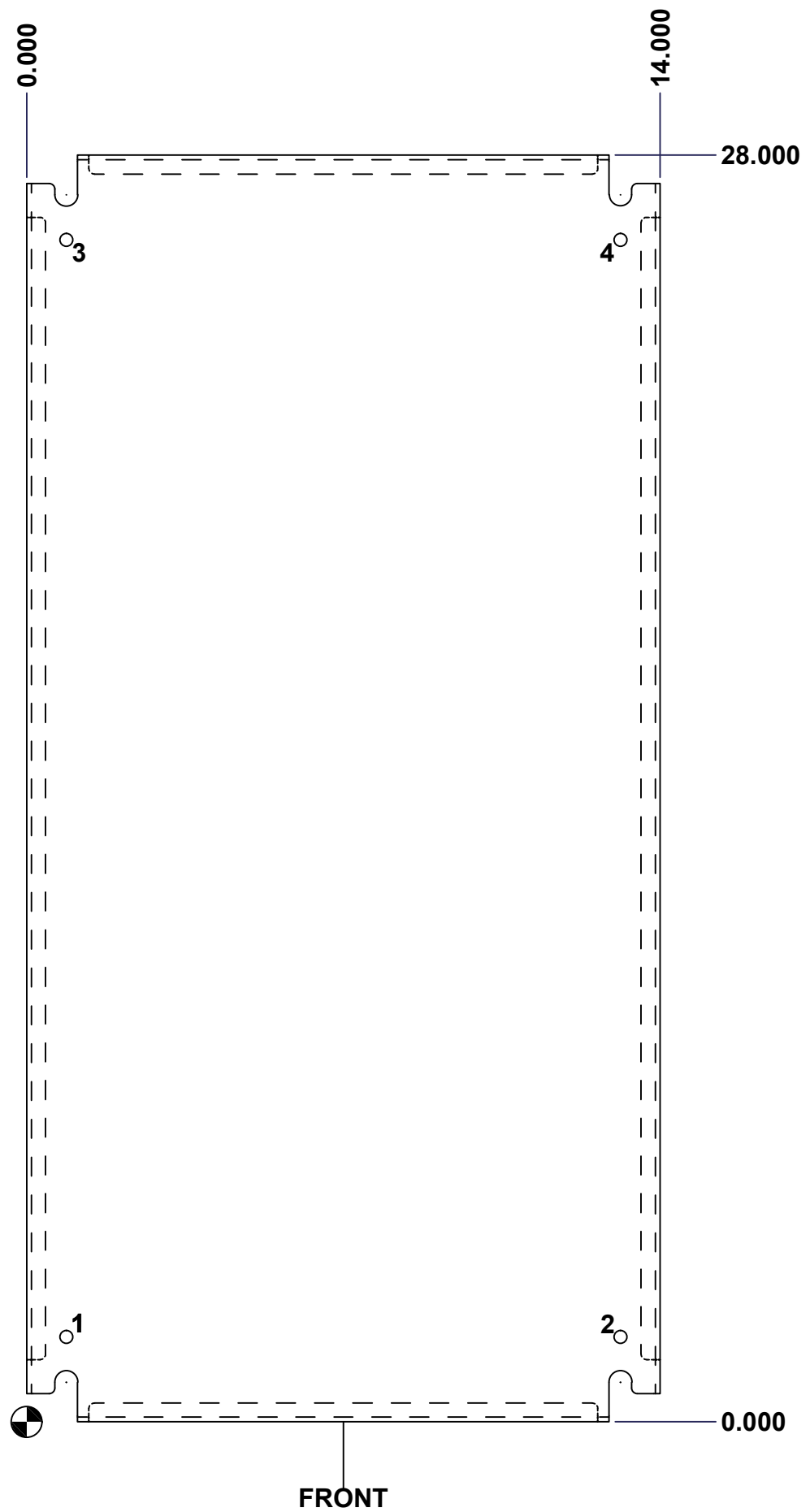

		Flatness Aplatissement Max 3.0mm Projection 
Tél: (450) 979-4373 Fax: (450) 979-4626 www.exmweb.com		Date Date 23-Jan-07
Customer Client	BoxCad	Date
Material Matière	See Part List	
Color Couleur	See Part List	Finish Fini See Part List
Description 881 SP - Inner Panel		Detail Rev.
Part Number Numéro Pièce	881 SP3016G	Rev. 2 0