

This drawing is confidential and must not be reproduced or used without the consent of EXM

Ce dessin est confidentiel et ne doit pas être reproduit ou utilisé sans le consentement de EXM

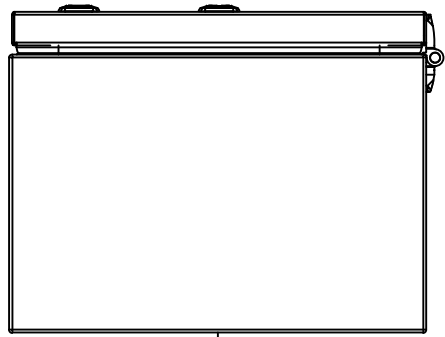

TOP

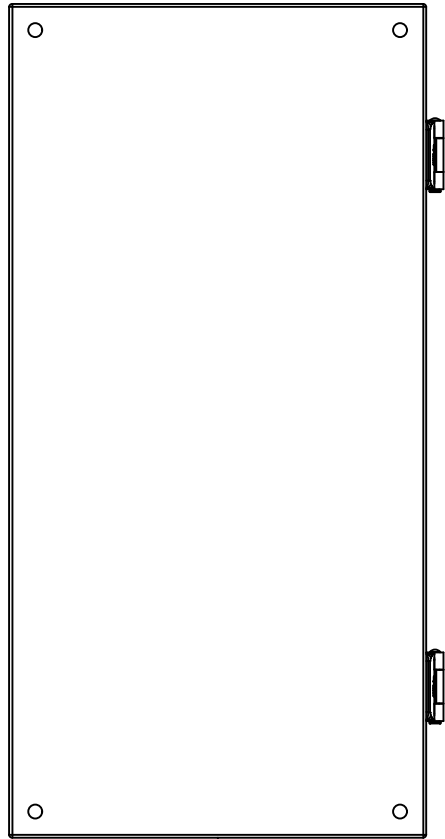

BACK

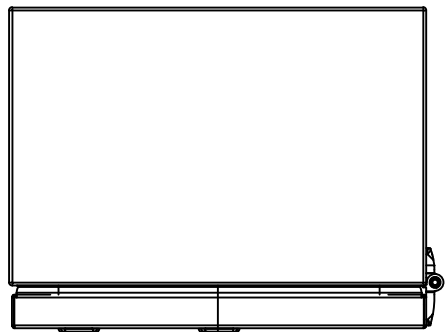

BOTTOM

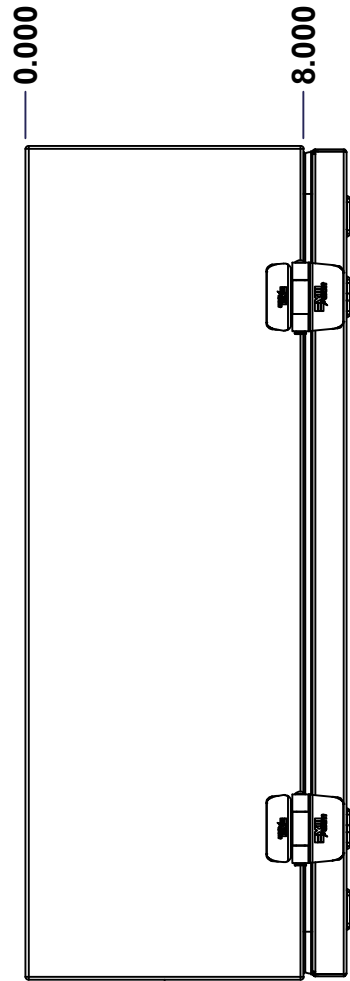

LEFT

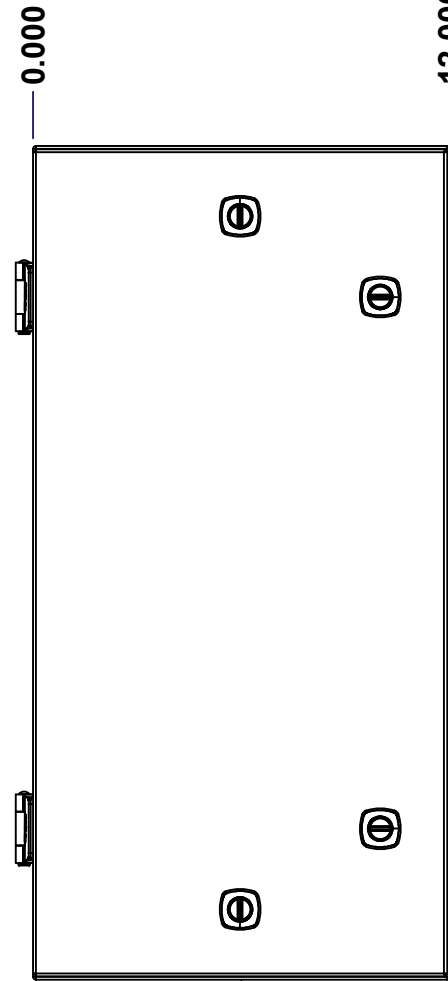

FRONT

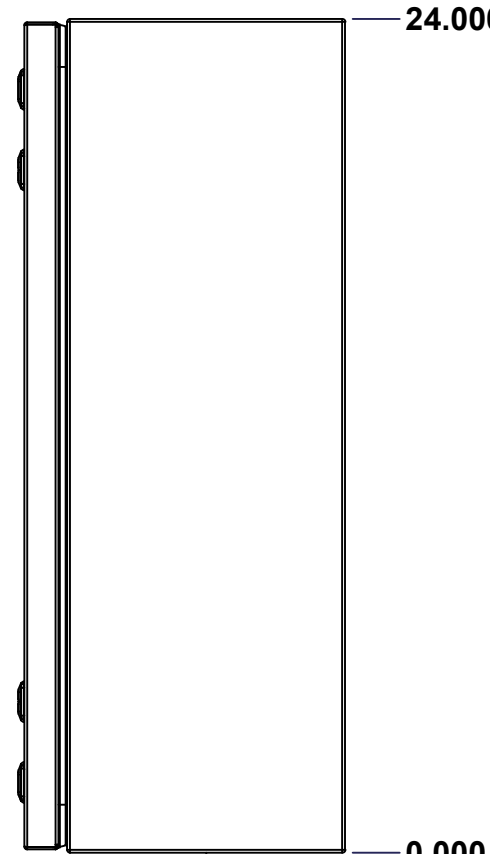

RIGHT

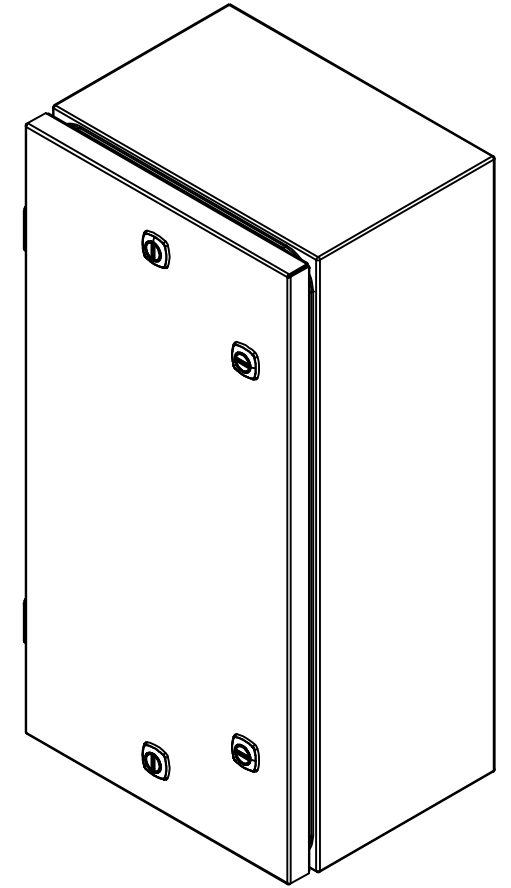

Isometric View

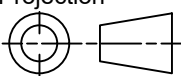

No.	Revisions	Date	By/Par

 Tél: (450) 979-4373 Fax: (450) 979-4626 www.exmweb.com		Flatness Aplatissement Max 3.0mm Projection 
Customer Client	Date	
Drawn By Dessiné Par	BoxCad: BoxCad	Date 04-Dec-24
Material Matière	16 Ga Cold Rolled A1008 CS Type B (1.4mm)	
Color Couleur	Asa-61 Grey	Finish Fini Smooth
Description	Detail Rev.	
5412ESDG 24" x 12" x 8" Assembly		
Part Number Numéro Pièce	Rev. 0	1 9
5412ESDG241208		

SEE BILL OF MATERIAL ON LAST PAGE

This drawing is confidential and must not be reproduced or used without the consent of EXM

Ce dessin est confidentiel et ne doit pas être reproduit ou utilisé sans le consentement de EXM

NOTE	
ITEM	DESCRIPTION
1	NEMA 4, 12 Enclosure (IP66)
2	C/W Standard ground studs on box and cover
3	W/O Standard door stiffener
4	C/W Standard inner panel (Included)
5	C/W Standard inner panel mounting studs

No.	Revisions	Date	By/Par

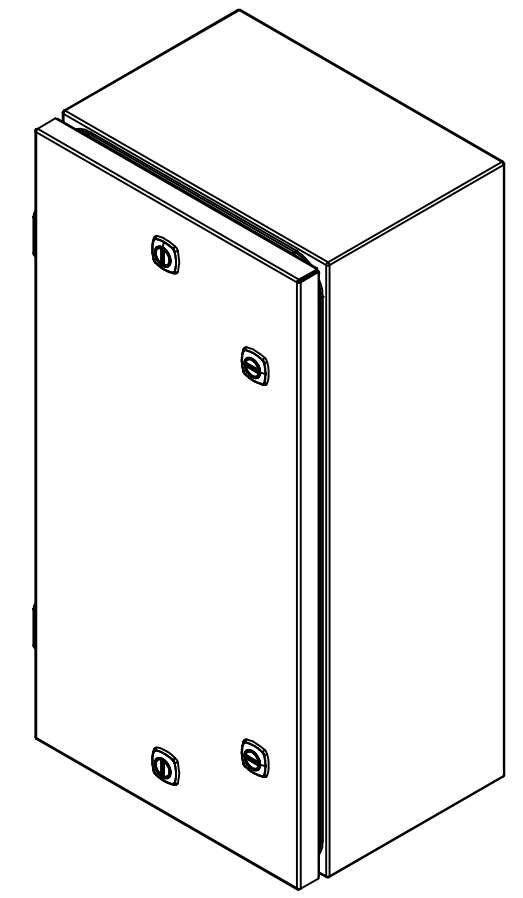

Isometric View





Tél: (450) 979-4373
Fax: (450) 979-4626
www.exmweb.com

Flatness
Aplatissement
Max 3.0mm

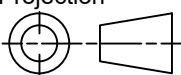
Projection

Customer Client	Date
Drawn By / Dessiné Par: BoxCad: BoxCad	Date: 04-Dec-24
Material / Matière: 16 Ga Cold Rolled A1008 CS Type B (1.4mm)	

PACKING		
ITEM	QTY	DESCRIPTION
Cardboard sleeve	2	Top and Bottom
Cardboard strip	2	Between back of enclosure and inner panel
Plastic bag	1	To protect cover surface and inside gasket
Plastic strap - Black	2	To Squeeze the 2 cardboard sleeve together
Packaging label	1	White label with product number

1	STK-K-01800	5	5412 ES Accessory Kit
1	885SP2412G	0	885SP 24" x 12" Inner Panel Part
2	STK-K-01320	0	5412 ES Inner Panel Accessory Kit
2	STK-Q-07220	1	M6 Nylon Insert Lock Nut
2	STK-Q-10252	0	M6 Stainless Steel Sealing Washer
1	5412ESDG241208C	0	5412ESDG 24" x 12" Cover
1	5412ESDG241208B	0	5412ESDG 24" x 12" x 8" Body
Qty	Part Number	Rev	Description
Parts List			

Color / Couleur: Asa-61 Grey	Finish / Fini: Smooth
Description: 5412ESDG 24" x 12" x 8" Assembly	
Part Number / Numéro Pièce: 5412ESDG241208	Rev. 0
2 / 9	

This drawing is confidential and must not be reproduced or used without the consent of EXM

Ce dessin est confidentiel et ne doit pas être reproduit ou utilisé sans le consentement de EXM

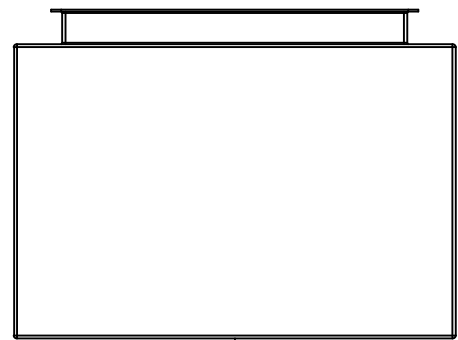

TOP

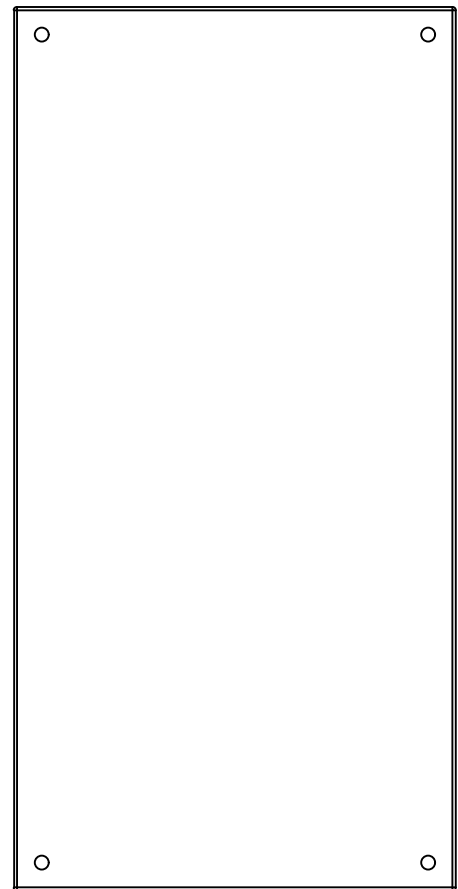

BACK

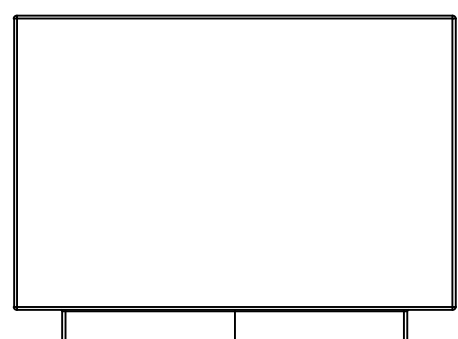

BOTTOM

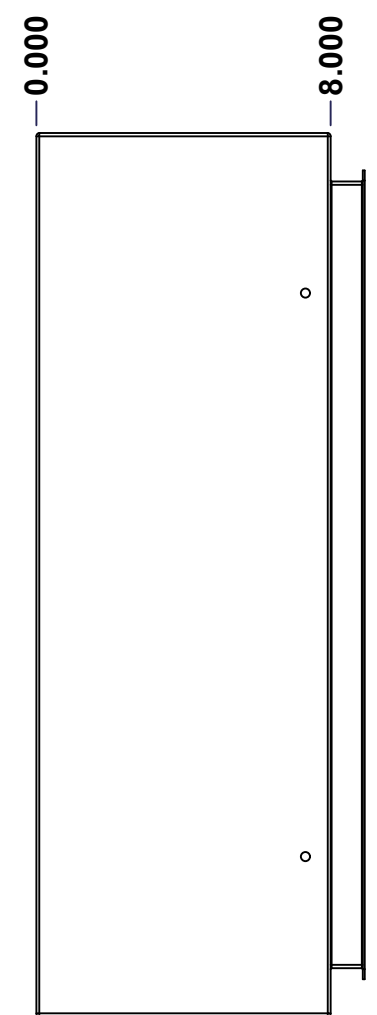

LEFT

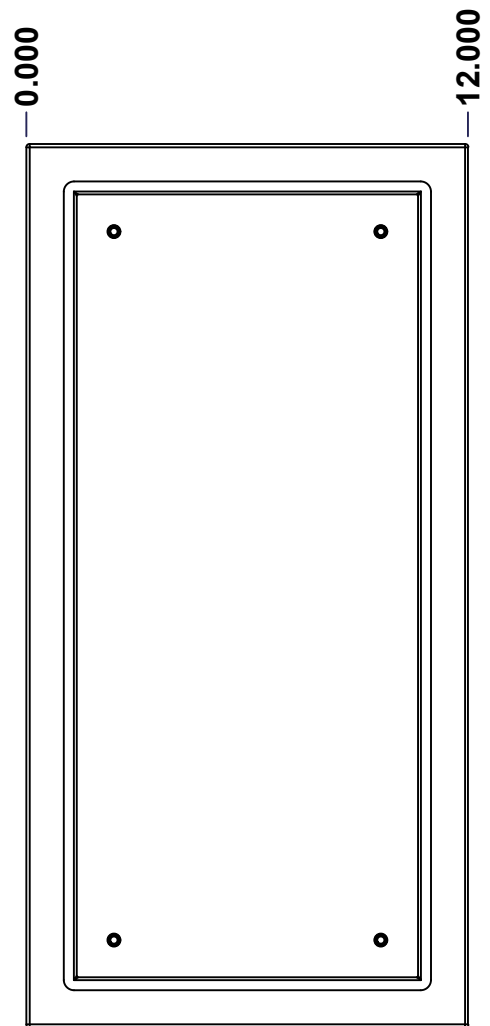

FRONT

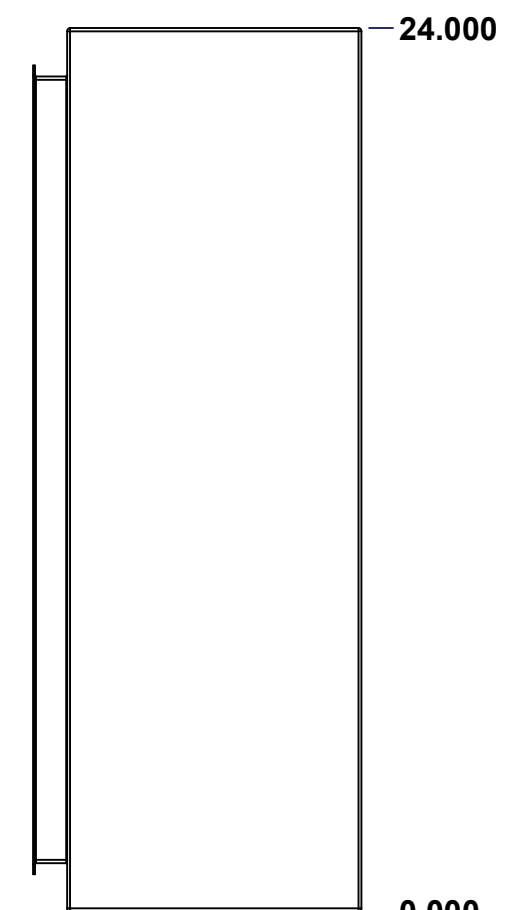

RIGHT

No.	Revisions	Date	By/Par

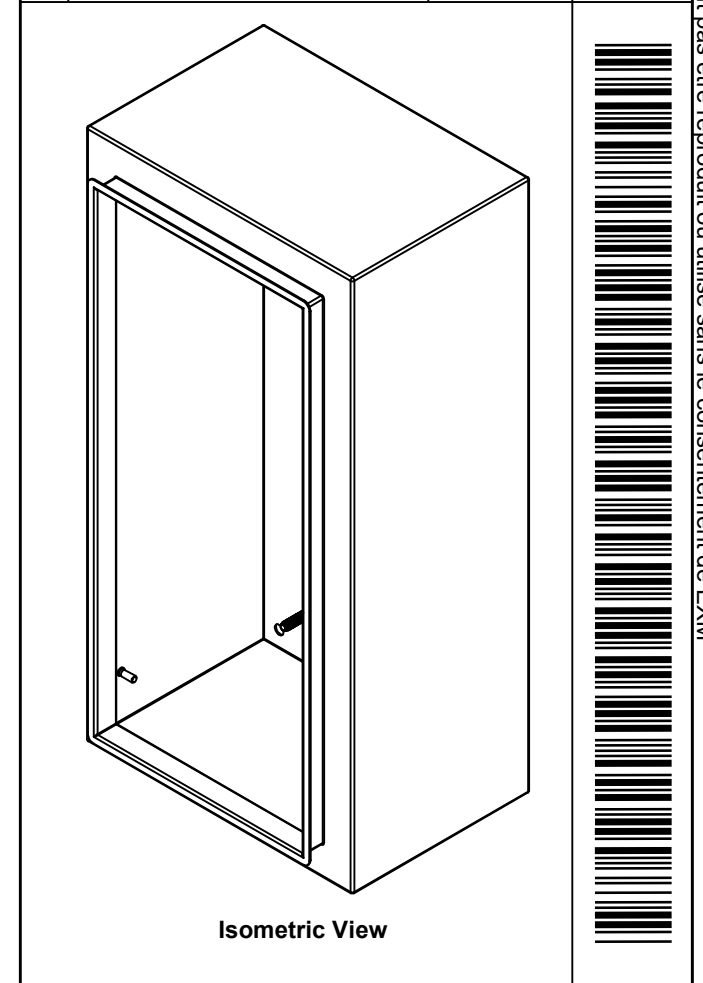

Isometric View

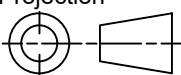

 Tél: (450) 979-4373 Fax: (450) 979-4626 www.exmweb.com		Flatness Aplatissement Max 3.0mm Projection 
Customer Client	Date	
Drawn By Dessiné Par	BoxCad: BoxCad	Date 04-Dec-24
Material Matière	16 Ga Cold Rolled A1008 CS Type B (1.4mm)	
Color Couleur	Asa-61 Grey	Finish Fini Smooth
Description	Detail Rev.	
5412ESDG 24" x 12" x 8" Body		
Part Number Numéro Pièce	Rev. 0	3 9
5412ESDG241208B		

SEE BILL OF MATERIAL ON LAST PAGE

This drawing is confidential and must not be reproduced or used without the consent of EXM

Ce dessin est confidentiel et ne doit pas être reproduit ou utilisé sans le consentement de EXM

STANDARD FEATURES ARE NOT LISTED IN THIS HOLE TABLE			
HOLE TABLE - LEFT VIEW (CUSTOM FEATURE ONLY)			
CUT-OUT	XDIM	YDIM	DESCRIPTION
1	6.500	2.000	GND STUD M6 x 16mm (Inside)

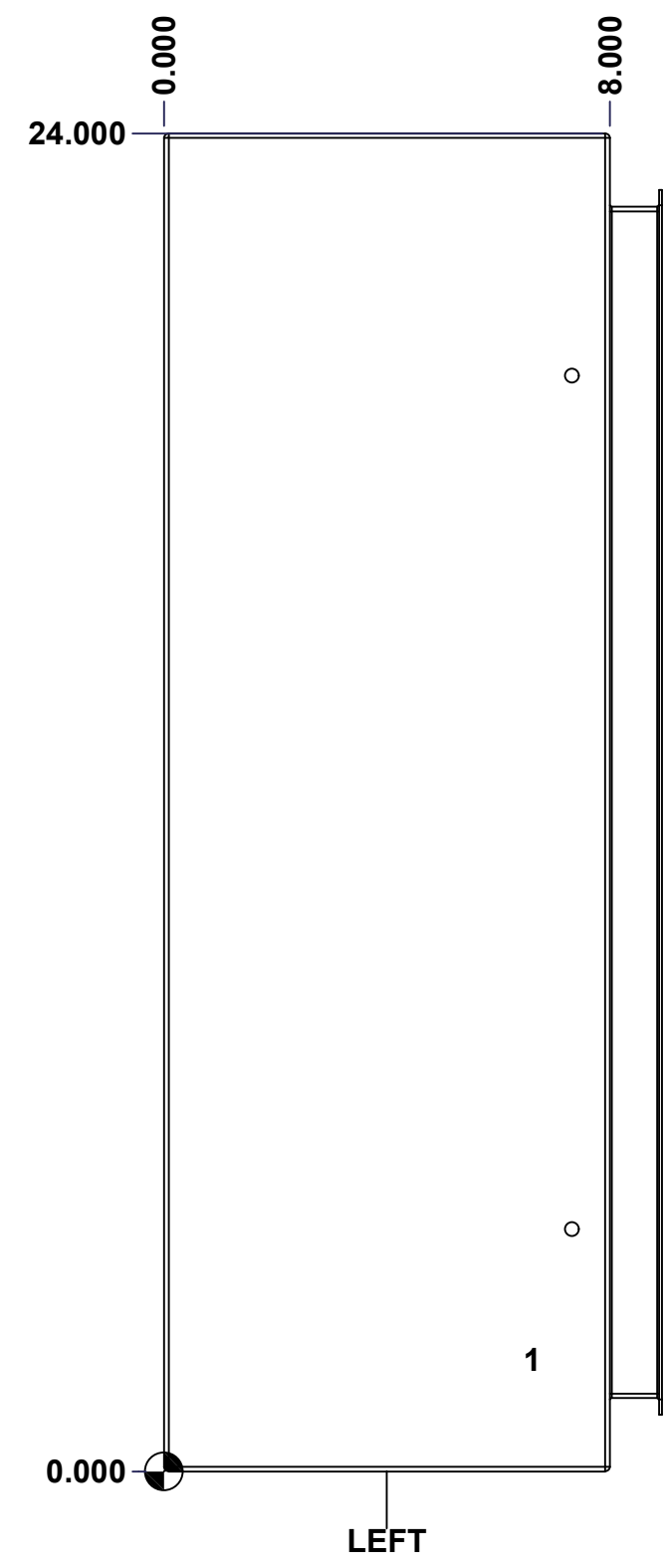

	Description	Status	
	5412ESDG 24" x 12" x 8" Body	(NULL)	
	Part Number Numéro Pièce	Rev.	
	5412ESDG241208B	0	4 9

This drawing is confidential and must not be reproduced or used without the consent of EXM

Ce dessin est confidentiel et ne doit pas être reproduit ou utilisé sans le consentement de EXM

STANDARD FEATURES ARE NOT LISTED IN THIS HOLE TABLE

HOLE TABLE - BACK VIEW (CUSTOM FEATURE ONLY)

CUT-OUT	XDIM	YDIM	DESCRIPTION
1	2.375	2.375	IP STUD M8 x 35mm (Inside)
2	2.375	21.625	IP STUD M8 x 35mm (Inside)
3	9.625	21.625	IP STUD M8 x 35mm (Inside)
4	9.625	2.375	IP STUD M8 x 35mm (Inside)

5	11.250	0.750	RND Ø0.390
6	11.250	23.250	RND Ø0.390
7	0.750	0.750	RND Ø0.390
8	0.750	23.250	RND Ø0.390

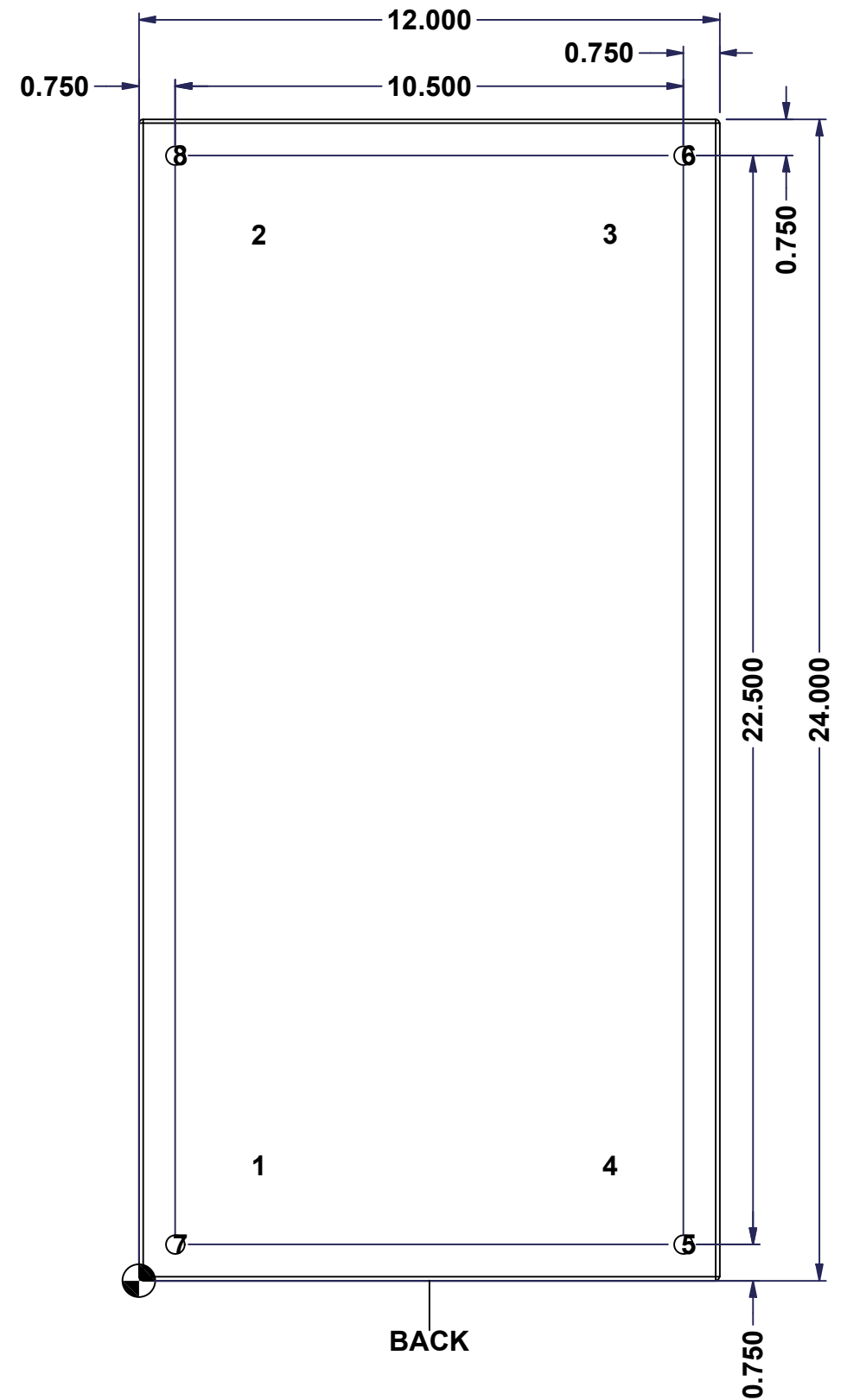

BACK

	Description	Status
	5412ESDG 24" x 12" x 8" Body	(NULL)
	Part Number	Rev.
	5412ESDG241208B	5
		9

This drawing is confidential and must not be reproduced or used without the consent of EXM

Ce dessin est confidentiel et ne doit pas être reproduit ou utilisé sans le consentement de EXM

No.	Revisions	Date	By/Par

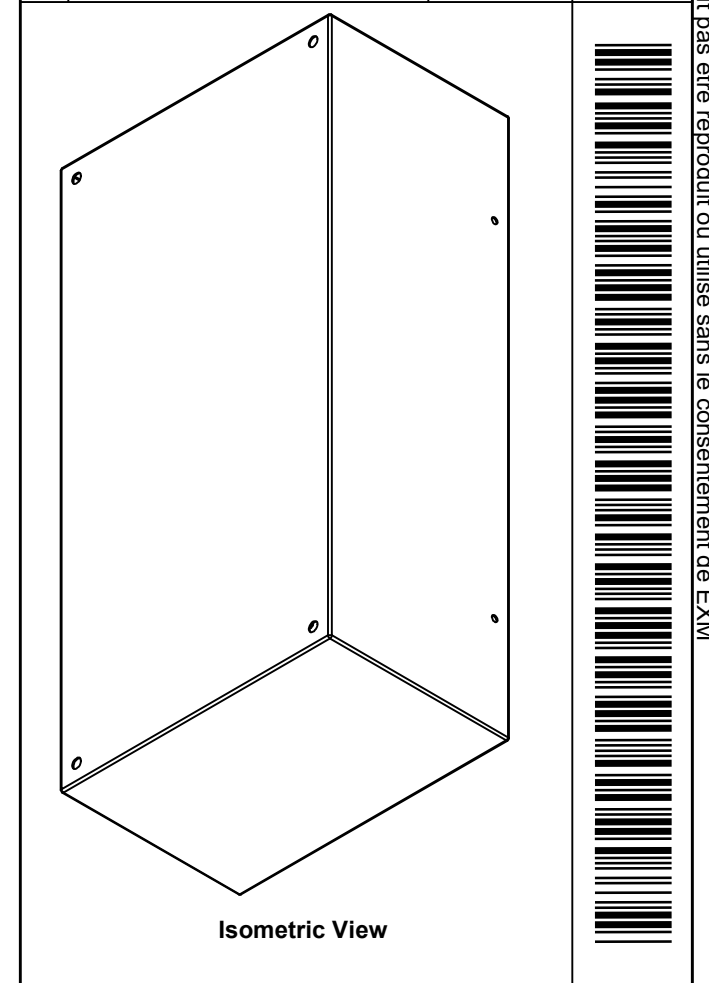

 Tél: (450) 979-4373 Fax: (450) 979-4626 www.exmweb.com		Flatness Aplatissement	
		Max 3.0mm	
Customer Client		Date	
Drawn By Dessiné Par BoxCad: BoxCad		Date 04-Dec-24	
Material Matière 16 Ga Cold Rolled A1008 CS Type B (1.4mm)			
Color Couleur Asa-61 Grey		Finish Fini Smooth	
Description 5412ESDG 24" x 12" x 8" Body			Detail Rev.
Part Number Numéro Pièce 5412ESDG241208B			Rev. 6
			9

Qty	Part Number	Rev	Description
1	STK-Q-16080	0	Ground Stud M6 x 16mm Steel
1	STK-P-02400S	0	Powder Paint (Asa-61 Grey / Smooth)
4	STK-Q-16005	0	Stud M8 x 35mm Steel
1	5412ESDG241208B-P	0	5412ESDG 24" x 12" x 8" Body Part
Parts List			

This drawing is confidential and must not be reproduced or used without the consent of EXM

Ce dessin est confidentiel et ne doit pas être reproduit ou utilisé sans le consentement de EXM

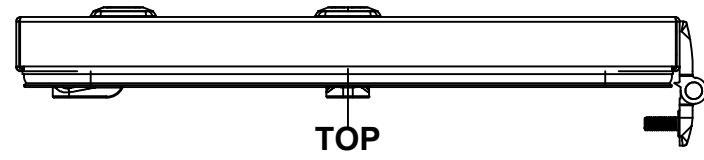

TOP

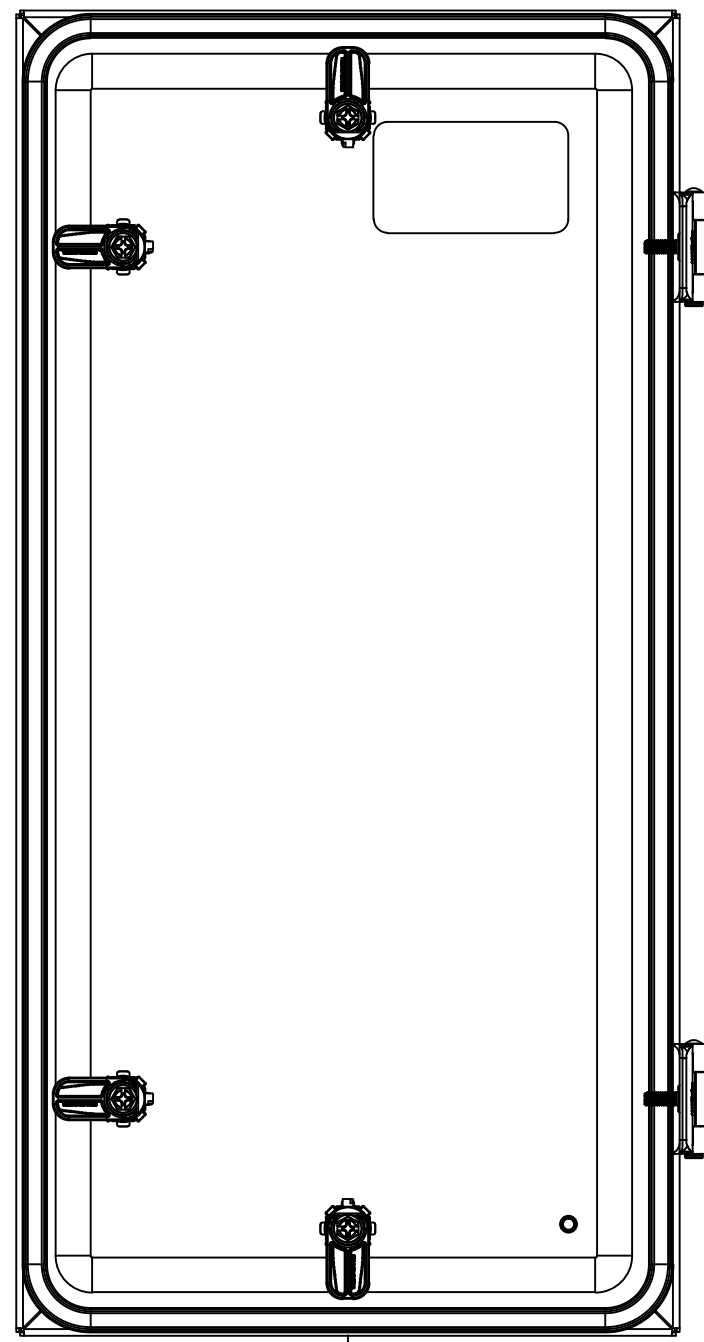

BACK

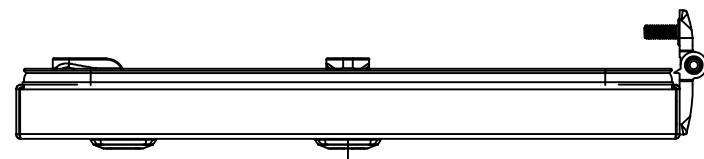

BOTTOM

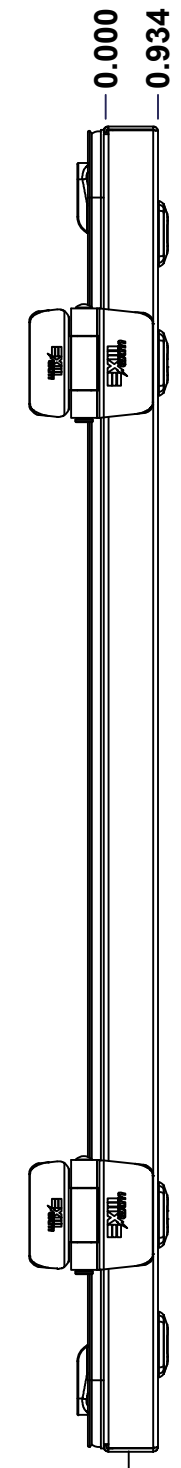

LEFT

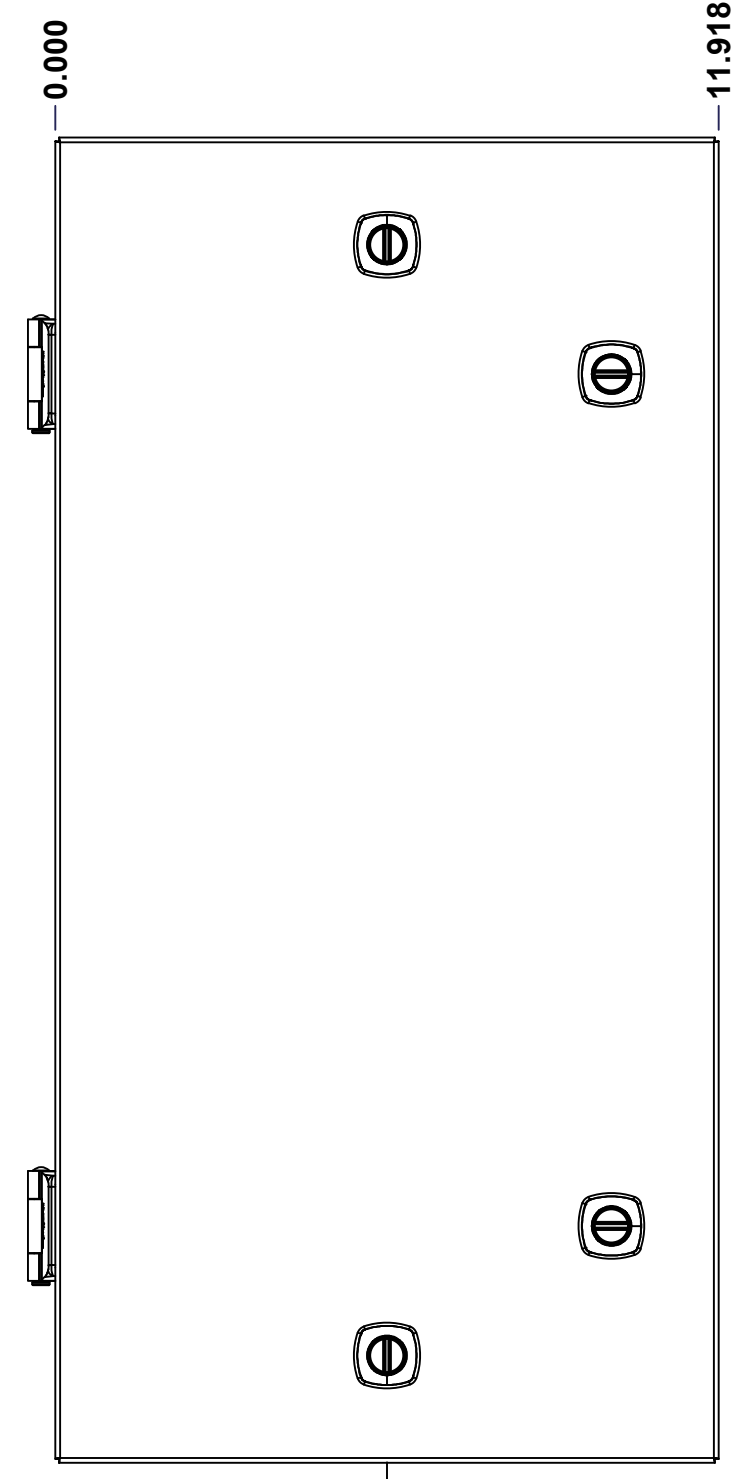

FRONT

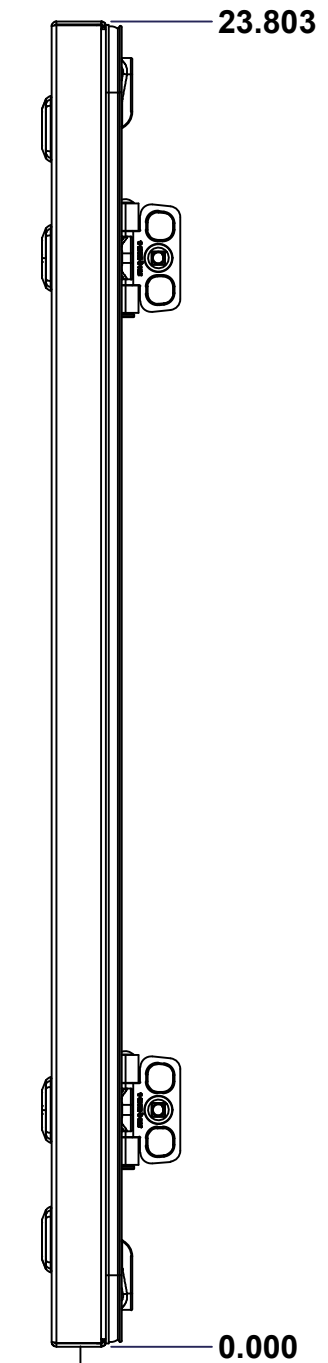

RIGHT

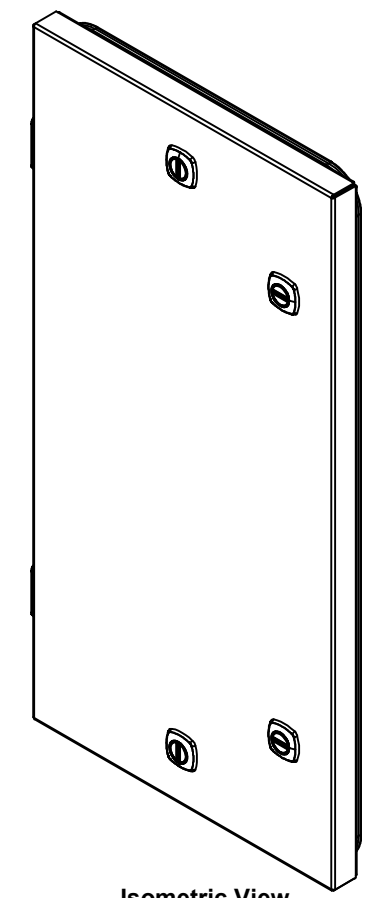

Isometric View

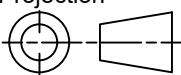

No.	Revisions	Date	By/Par

 Tél: (450) 979-4373 Fax: (450) 979-4626 www.exmweb.com		Flatness Aplatissement Max 3.0mm Projection 
Customer Client	Date	
Drawn By Dessiné Par	BoxCad: BoxCad	Date 04-Dec-24
Material Matière	16 Ga Cold Rolled A1008 CS Type B (1.4mm)	
Color Couleur	Asa-61 Grey	Finish Fini Smooth
Description 5412ESDG 24" x 12" Cover		Detail Rev.
Part Number Numéro Pièce	Rev. 0	7 9

SEE BILL OF MATERIAL ON LAST PAGE

5412ESDG241208C

This drawing is confidential and must not be reproduced or used without the consent of EXM

Ce dessin est confidentiel et ne doit pas être reproduit ou utilisé sans le consentement de EXM

STANDARD FEATURES ARE NOT LISTED IN THIS HOLE TABLE

HOLE TABLE - FRONT VIEW (CUSTOM FEATURE ONLY)

CUT-OUT	XDIM	YDIM	DESCRIPTION
1	3.750	20.803	LABEL_EXM (Inside)
2	2.000	2.000	GND STUD M6 x 16mm (Inside)
3	9.994	19.553	LOCK 880 SCQ4-SL @ 0.0°
4	5.959	21.879	LOCK 880 SCQ4-SL @ 90.0°
5	9.994	4.250	LOCK 880 SCQ4-SL @ 0.0°
6	5.959	1.924	LOCK 880 SCQ4-SL @ 270.0°

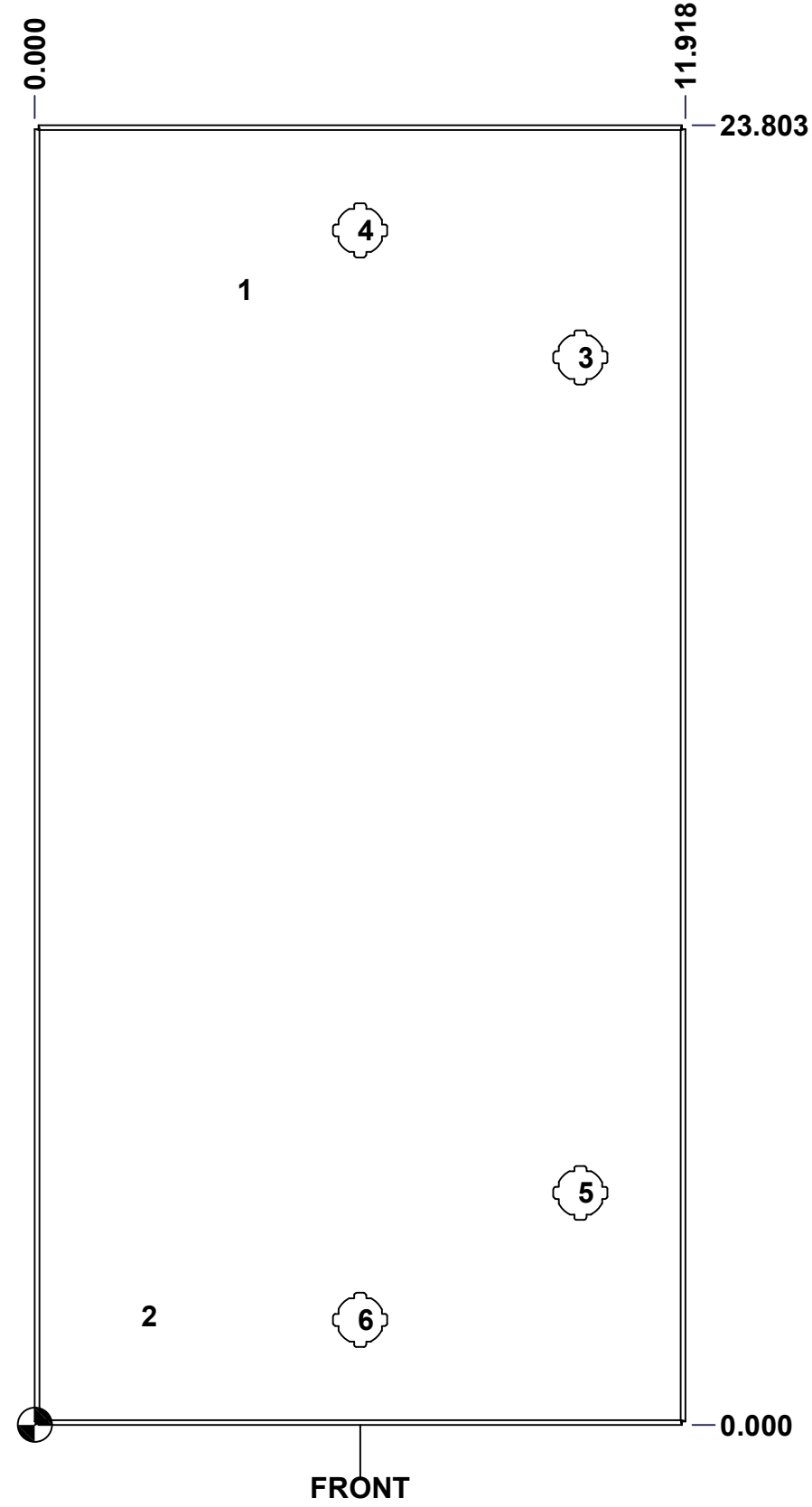

	Description	Status
	5412ESDG 24" x 12" Cover	(NULL)
	Part Number Numéro Pièce	Rev.
	5412ESDG241208C	0
		8
		9

This drawing is confidential and must not be reproduced or used without the consent of EXM

Ce dessin est confidentiel et ne doit pas être reproduit ou utilisé sans le consentement de EXM

No.	Revisions	Date	By/Par

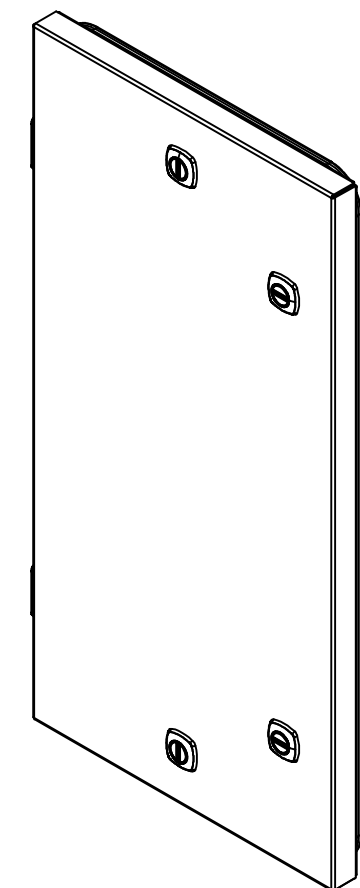

Isometric View



 Tél: (450) 979-4373
 Fax: (450) 979-4626
www.exmweb.com

Flatness
 Aplatissement
 Max 3.0mm
 Projection



4	STK-K-12500	19	5412 ES 1/4 Turn Lock
1	STK-Q-16080	0	Ground Stud M6 x 16mm Steel
1	STK-S-00100	0	3.5" x 2" Silver Milar Flexcon Sticker
1	STK-P-02400S	0	Powder Paint (Asa-61 Grey / Smooth)
2	STK-Q-07220	1	M6 Nylon Insert Lock Nut
2	STK-Q-10252	0	M6 Stainless Steel Sealing Washer
2	STK-A-02360	2	External Hinge for Double Gasket
1	5412ESDG241208G2	0	5412ESDG 24" x 12" Cover Gasket
1	5412ESDG241208G	0	5412ESDG 24" x 12" Cover Gasket
1	5412ESDG241208C-P	0	5412ESDG 24" x 12" Cover Part

Customer Client	Date
Drawn By Dessiné Par BoxCad: BoxCad	Date 04-Dec-24
Material Matière 16 Ga Cold Rolled A1008 CS Type B (1.4mm)	
Color Couleur Asa-61 Grey	Finish Fini Smooth
Description 5412ESDG 24" x 12" Cover	Detail Rev.
Part Number Numéro Pièce 5412ESDG241208C	Rev. 9 0

QTY	Part Number	Rev	Description
Parts List			

This drawing is confidential and must not be reproduced or used without the consent of EXM

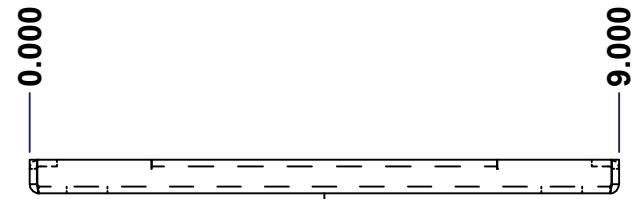
Ce dessin est confidentiel et ne doit pas être reproduit ou utilisé sans le consentement de EXM



TOP

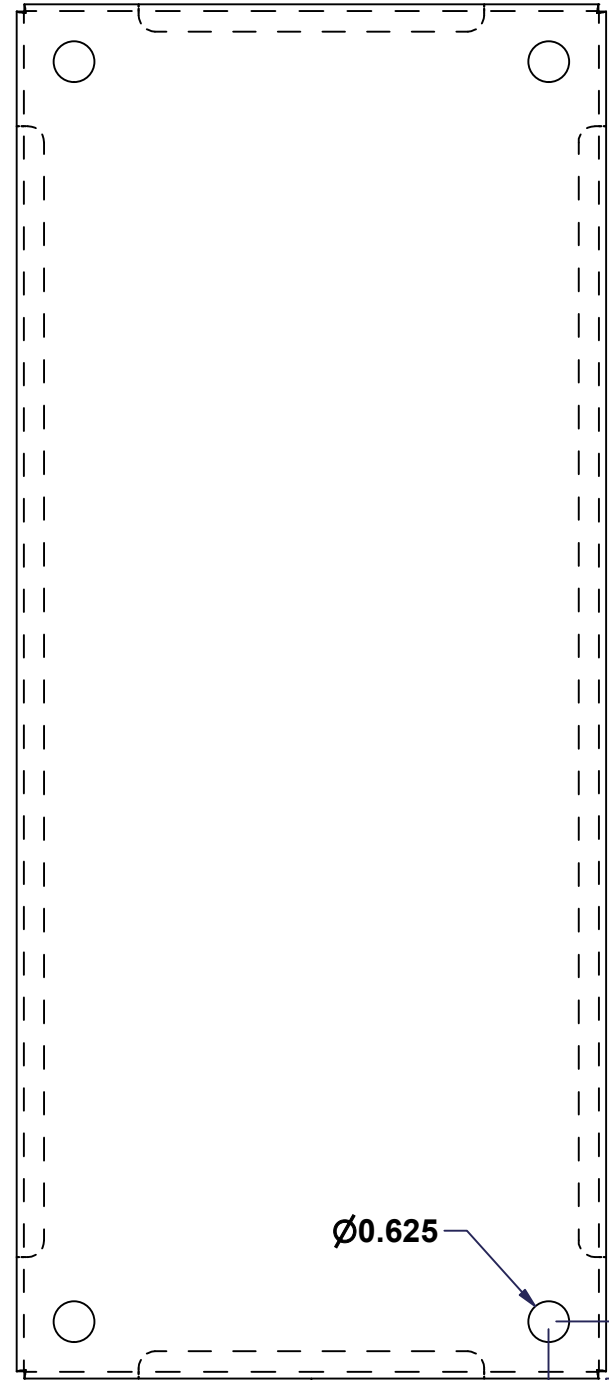

FRONT

0.512 21.000

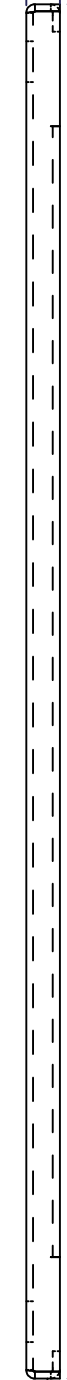

RIGHT

0.000

No.	Revisions	Date	By/Par

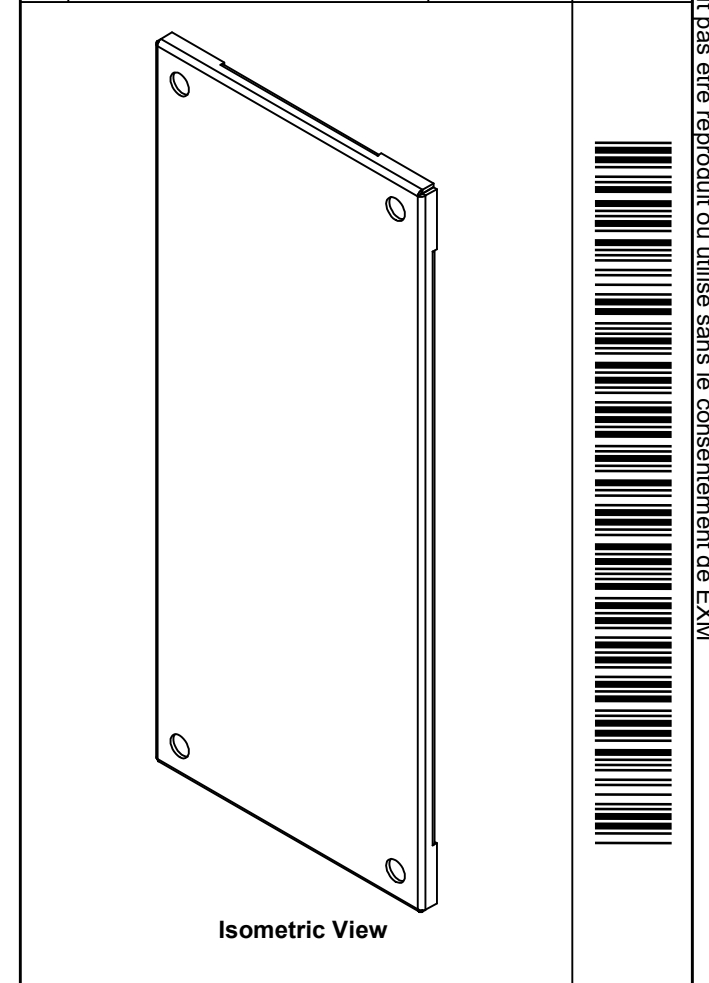

Isometric View

	Flatness Aplatissement Max 3.0mm
	Projection
Customer Client	Date
Drawn By Dessiné Par BoxCad: nickz	Date 01/03/2017
Material Matière 12 Ga Galvanized (2.5mm)	
Color Couleur See Part List	Finish Fini See Part List
Description 885SP 24" x 12" Inner Panel Part	
Part Number Numéro Pièce 885SP2412G	
Detail Rev.	Rev. 1 0

Qty	Part Number	Rev	Description	Material	Color	Finish
1	885SP2412G-P	0	885SP 24" x 12" Inner Panel Part	12 Ga Galvanized (2.5mm)	Unpainted	Galvanized

Parts List