

This drawing is confidential and must not be reproduced or used without the consent of EXM

Ce dessin est confidentiel et ne doit pas être reproduit ou utilisé sans le consentement de EXM

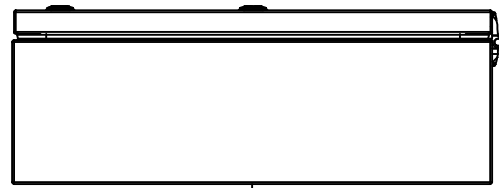

TOP

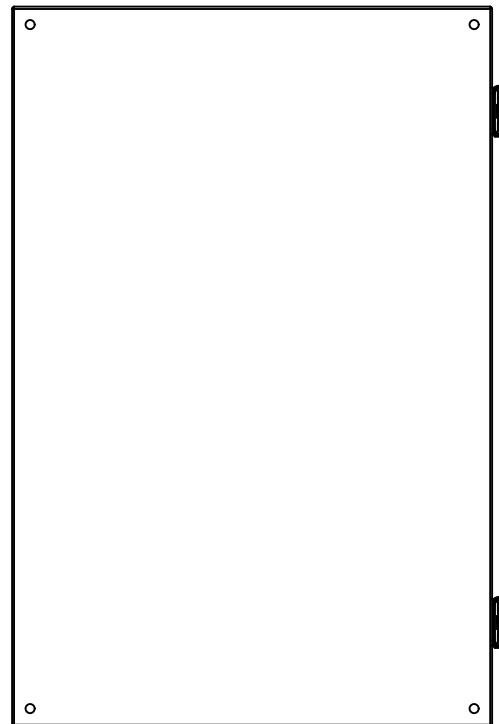

BACK

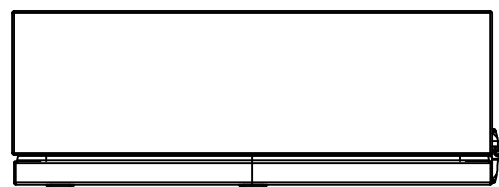

BOTTOM

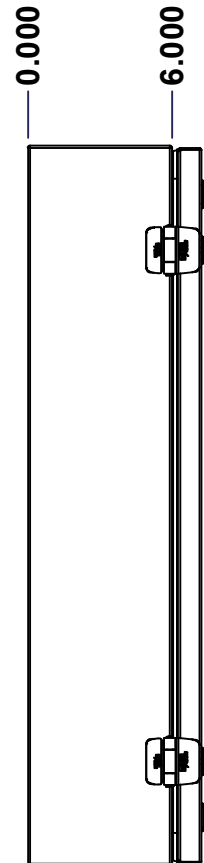

LEFT

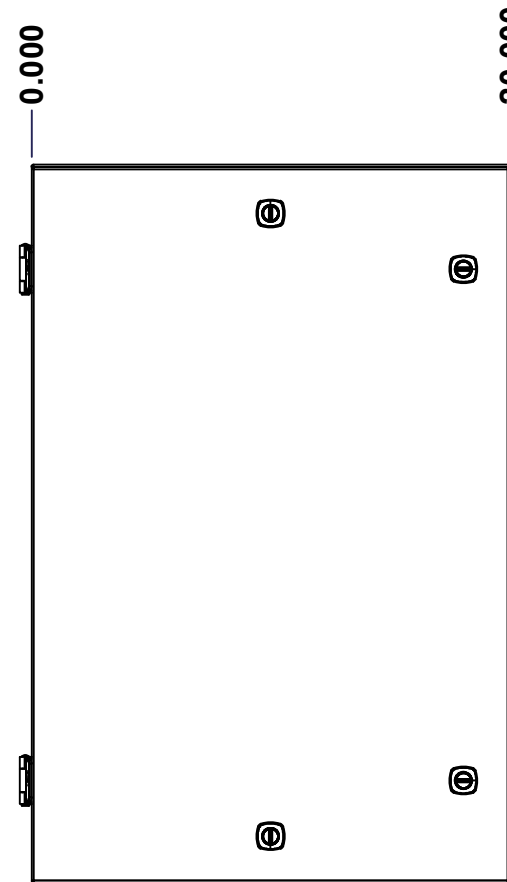

FRONT

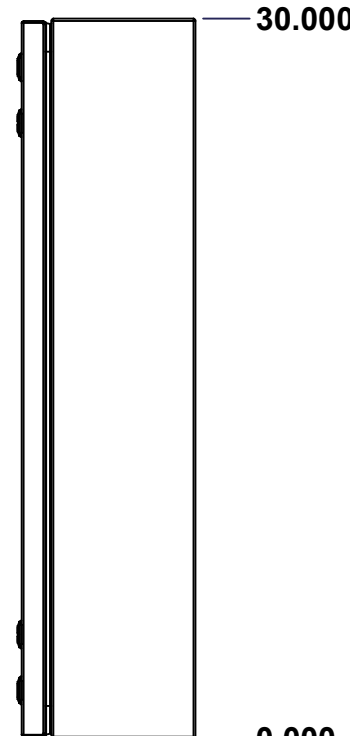

RIGHT

No.	Revisions	Date	By/Par

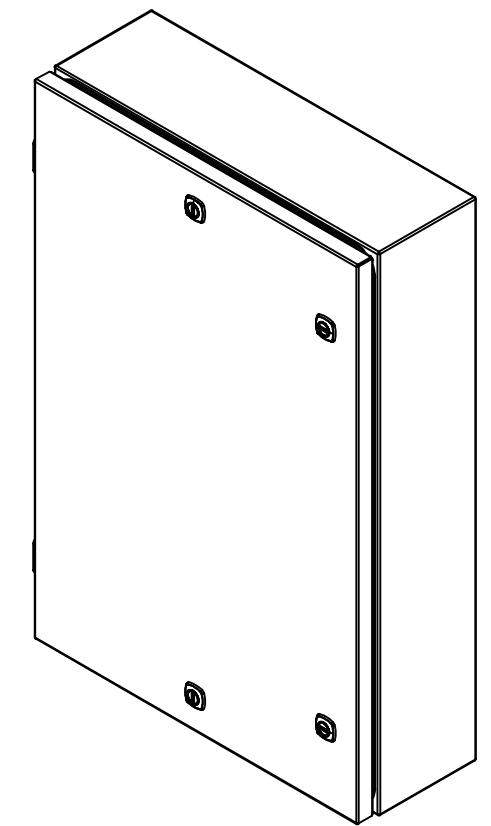

Isometric View

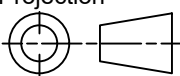

 Tél: (450) 979-4373 Fax: (450) 979-4626 www.exmweb.com		Flatness Aplatissement Max 3.0mm Projection 
Customer Client	Date	
Drawn By Dessiné Par	BoxCad: BoxCad	Date 04-Dec-24
Material Matière	16 Ga Cold Rolled A1008 CS Type B (1.4mm)	
Color Couleur	Asa-61 Grey	Finish Fini Smooth
Description	Detail Rev.	
5412ESDG 30" x 20" x 6" Assembly		
Part Number Numéro Pièce	Rev.	1
5412ESDG302006	0	9

SEE BILL OF MATERIAL ON LAST PAGE

This drawing is confidential and must not be reproduced or used without the consent of EXM

Ce dessin est confidentiel et ne doit pas être reproduit ou utilisé sans le consentement de EXM

NOTE	
ITEM	DESCRIPTION
1	NEMA 4, 12 Enclosure (IP66)
2	C/W Standard ground studs on box and cover
3	W/O Standard door stiffener
4	C/W Standard inner panel (Included)
5	C/W Standard inner panel mounting studs

No.	Revisions	Date	By/Par

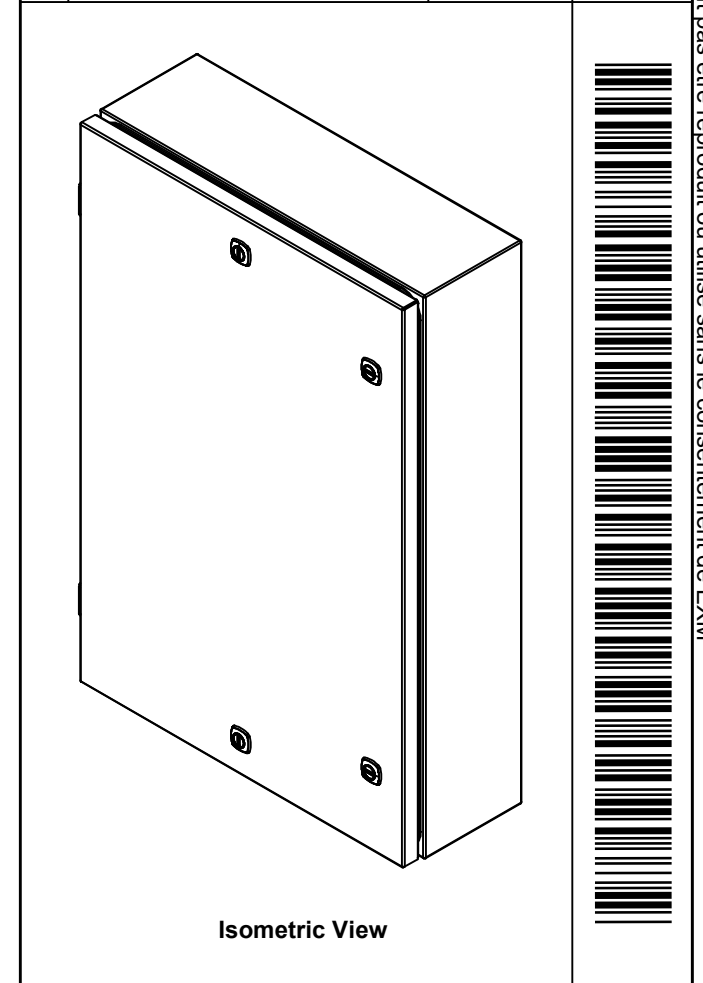



Tél: (450) 979-4373
Fax: (450) 979-4626
www.exmweb.com

Flatness
Aplatissement
Max 3.0mm

Projection

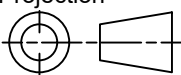

Customer Client	Date
Drawn By Dessiné Par BoxCad: BoxCad	Date 04-Dec-24
Material Matière 16 Ga Cold Rolled A1008 CS Type B (1.4mm)	

PACKING		
ITEM	QTY	DESCRIPTION
Cardboard sleeve	2	Top and Bottom
Cardboard strip	2	Between back of enclosure and inner panel
Plastic bag	1	To protect cover surface and inside gasket
Plastic strap - Black	2	To Squeeze the 2 cardboard sleeve together
Packaging label	1	White label with product number

1	885SP3020G	0	885SP 30" x 20" Inner Panel Part
2	STK-K-01320	0	5412 ES Inner Panel Accessory Kit
1	STK-K-01800	5	5412 ES Accessory Kit
2	STK-Q-10252	0	M6 Stainless Steel Sealing Washer
1	5412ESDG302006C	0	5412ESDG 30" x 20" Cover
1	5412ESDG302006B	0	5412ESDG 30" x 20" x 6" Body
2	STK-Q-07220	1	M6 Nylon Insert Lock Nut
Qty	Part Number	Rev	Description
Parts List			

Color Couleur	Asa-61 Grey	Finish Fini	Smooth
Description	5412ESDG 30" x 20" x 6" Assembly		
Part Number Numéro Pièce	5412ESDG302006		Rev. 2
			0
			9

This drawing is confidential and must not be reproduced or used without the consent of EXM

Ce dessin est confidentiel et ne doit pas être reproduit ou utilisé sans le consentement de EXM

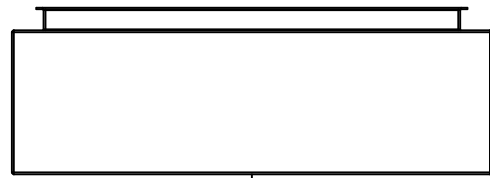

TOP

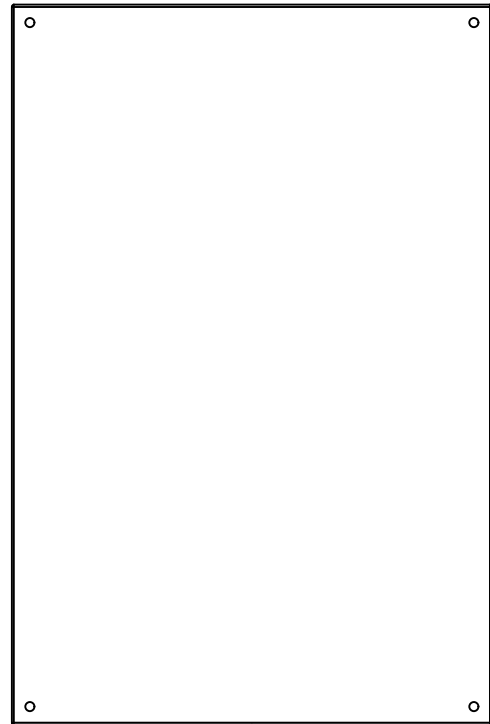

BACK

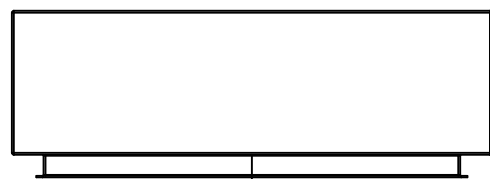

BOTTOM

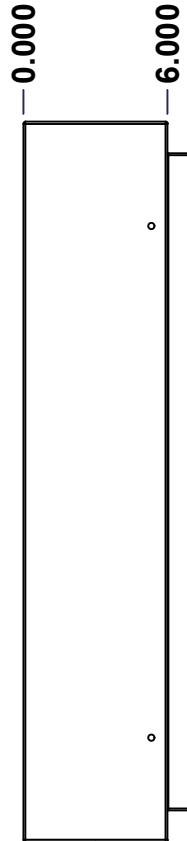

LEFT

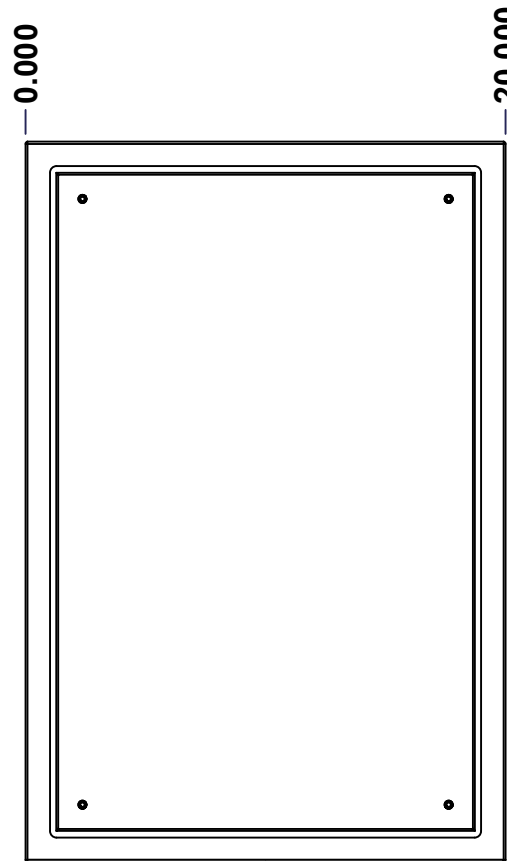

FRONT



RIGHT

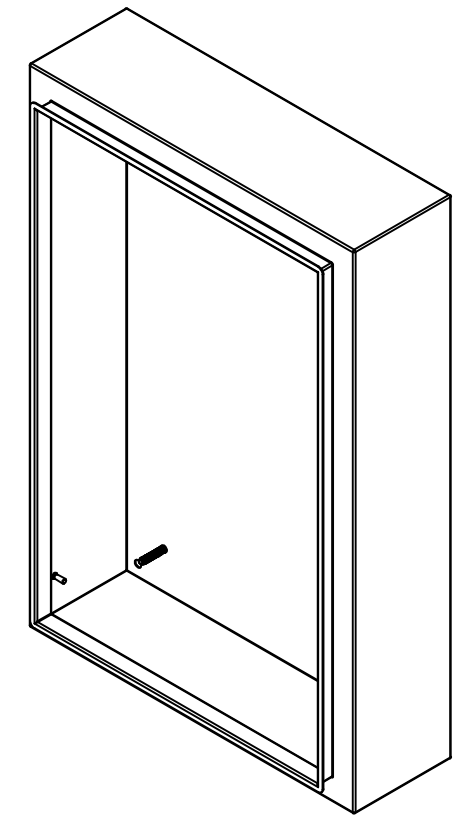

Isometric View

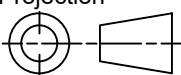

No.	Revisions	Date	By/Par

 Tél: (450) 979-4373 Fax: (450) 979-4626 www.exmweb.com		Flatness Aplatissement Max 3.0mm Projection 
Customer Client	Date	
Drawn By Dessiné Par	BoxCad: BoxCad	Date 04-Dec-24
Material Matière	16 Ga Cold Rolled A1008 CS Type B (1.4mm)	
Color Couleur	Asa-61 Grey	Finish Fini Smooth
Description	Detail Rev.	
5412ESDG 30" x 20" x 6" Body		
Part Number Numéro Pièce	Rev.	3
5412ESDG302006B	0	9

SEE BILL OF MATERIAL ON LAST PAGE

This drawing is confidential and must not be reproduced or used without the consent of EXM

Ce dessin est confidentiel et ne doit pas être reproduit ou utilisé sans le consentement de EXM

STANDARD FEATURES ARE NOT LISTED IN THIS HOLE TABLE			
HOLE TABLE - LEFT VIEW (CUSTOM FEATURE ONLY)			
CUT-OUT	XDIM	YDIM	DESCRIPTION
1	4.500	2.000	GND STUD M6 x 16mm (Inside)

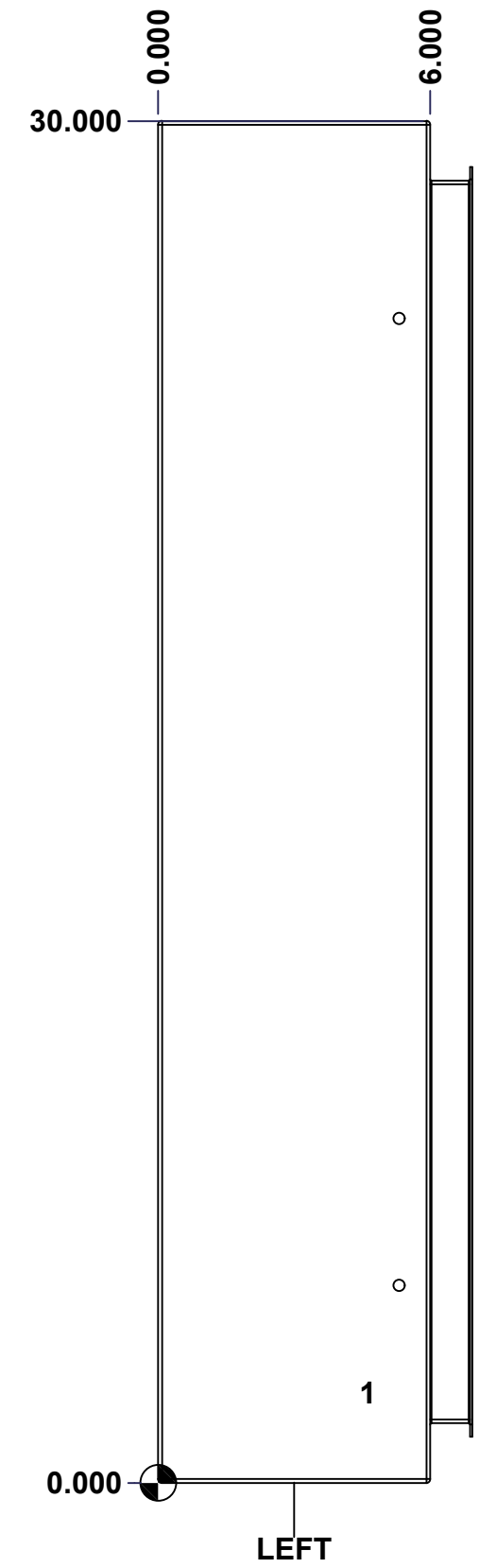

	Description	Status	
	5412ESDG 30" x 20" x 6" Body	(NULL)	
	Part Number Numéro Pièce	Rev.	
	5412ESDG302006B	0	4 9

This drawing is confidential and must not be reproduced or used without the consent of EXM

Ce dessin est confidentiel et ne doit pas être reproduit ou utilisé sans le consentement de EXM

STANDARD FEATURES ARE NOT LISTED IN THIS HOLE TABLE

HOLE TABLE - BACK VIEW (CUSTOM FEATURE ONLY)

CUT-OUT	XDIM	YDIM	DESCRIPTION
1	2.375	2.375	IP STUD M8 x 35mm (Inside)
2	2.375	27.625	IP STUD M8 x 35mm (Inside)
3	17.625	27.625	IP STUD M8 x 35mm (Inside)
4	17.625	2.375	IP STUD M8 x 35mm (Inside)

5	19.250	0.750	RND Ø0.390
6	19.250	29.250	RND Ø0.390
7	0.750	29.250	RND Ø0.390
8	0.750	0.750	RND Ø0.390

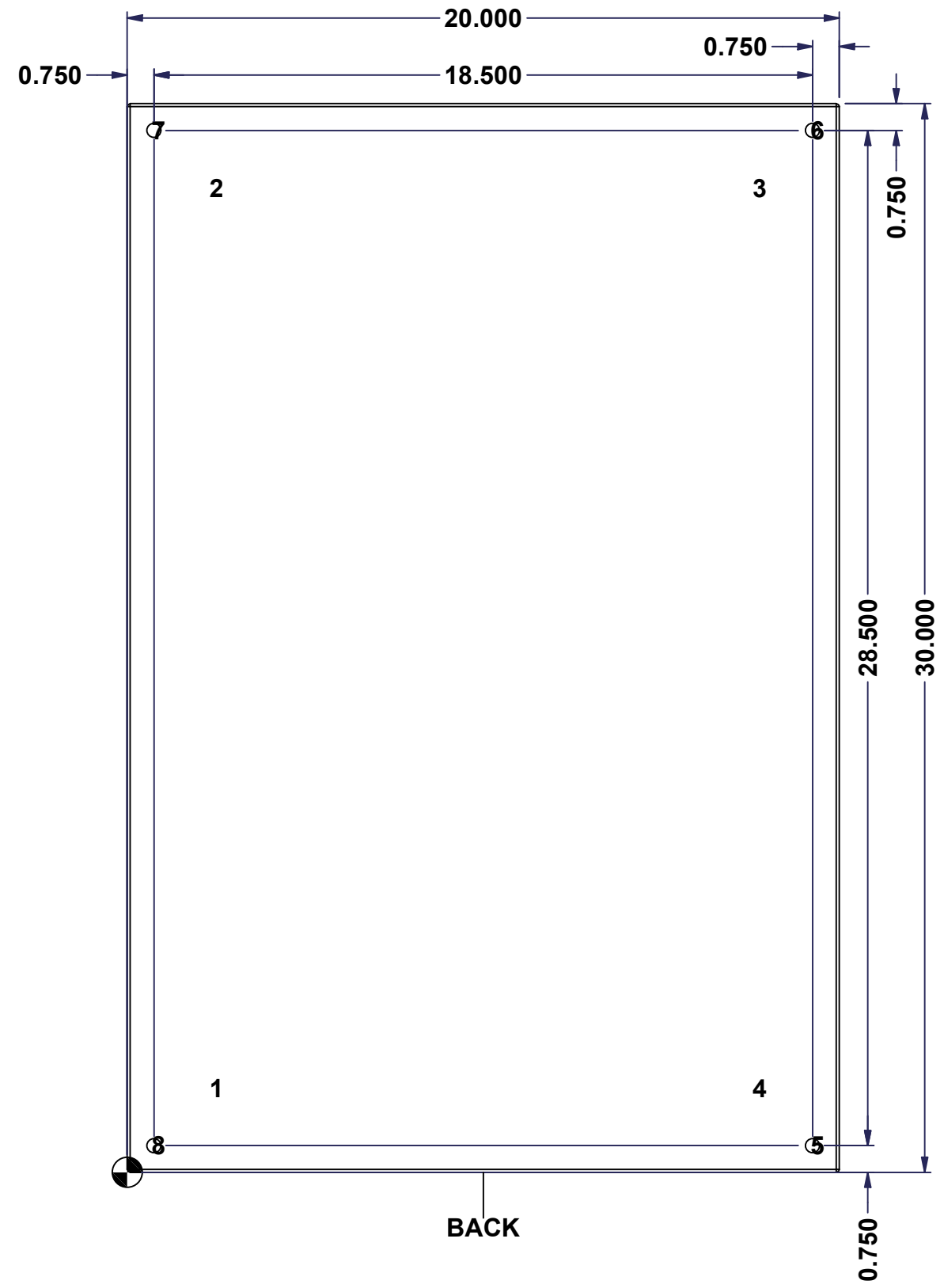

BACK

	Description	Status
	5412ESDG 30" x 20" x 6" Body	(NULL)
	Part Number Numéro Pièce	Rev.
	5412ESDG302006B	0 / 5
		9

This drawing is confidential and must not be reproduced or used without the consent of EXM

Ce dessin est confidentiel et ne doit pas être reproduit ou utilisé sans le consentement de EXM

No.	Revisions	Date	By/Par

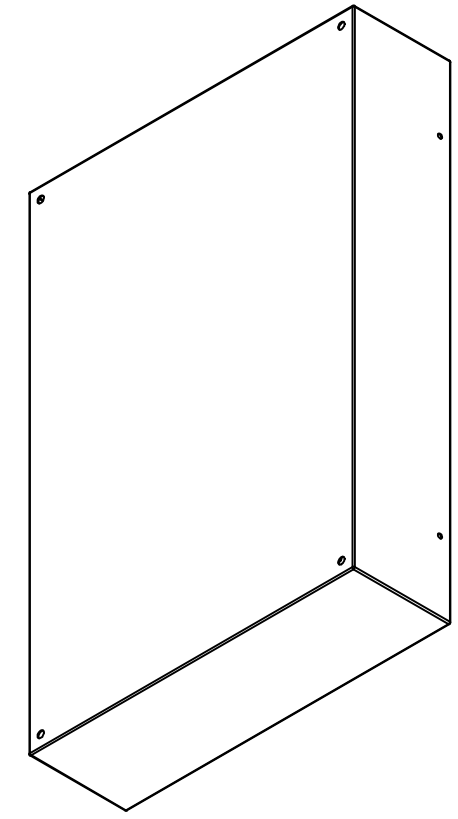

Isometric View

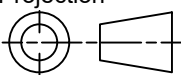

 Tél: (450) 979-4373 Fax: (450) 979-4626 www.exmweb.com		Flatness Aplatissement Max 3.0mm
Customer Client		Projection 
Drawn By Dessiné Par BoxCad: BoxCad		Date 04-Dec-24
Material Matière 16 Ga Cold Rolled A1008 CS Type B (1.4mm)		
Color Couleur Asa-61 Grey	Finish Fini Smooth	
Description 5412ESDG 30" x 20" x 6" Body		Detail Rev.
Part Number Numéro Pièce 5412ESDG302006B		Rev. 6 0

Qty	Part Number	Rev	Description
1	STK-Q-16080	0	Ground Stud M6 x 16mm Steel
1	STK-P-02400S	0	Powder Paint (Asa-61 Grey / Smooth)
4	STK-Q-16005	0	Stud M8 x 35mm Steel
1	5412ESDG302006B-P	0	5412ESDG 30" x 20" x 6" Body Part
Parts List			

This drawing is confidential and must not be reproduced or used without the consent of EXM

Ce dessin est confidentiel et ne doit pas être reproduit ou utilisé sans le consentement de EXM

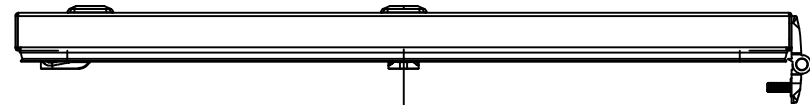

TOP

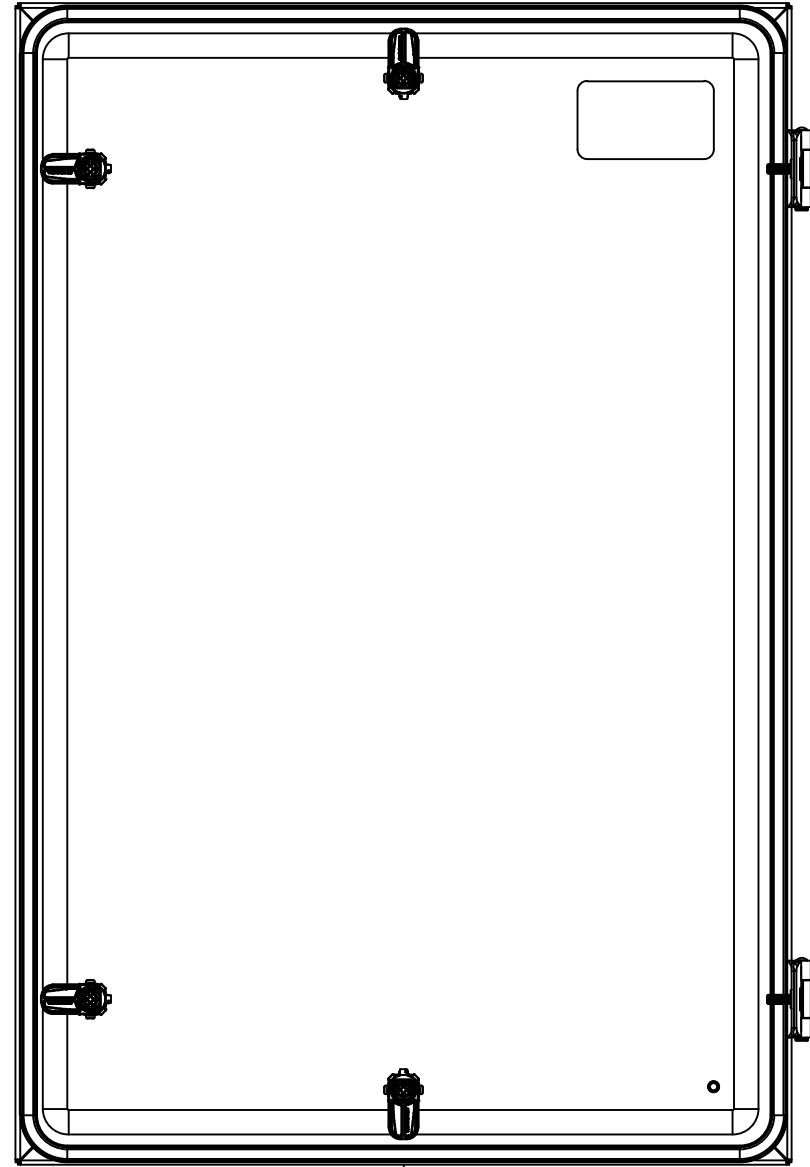

BACK

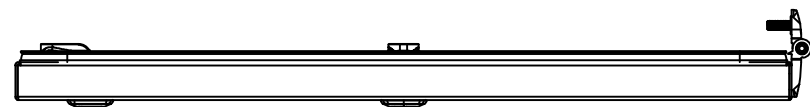

BOTTOM

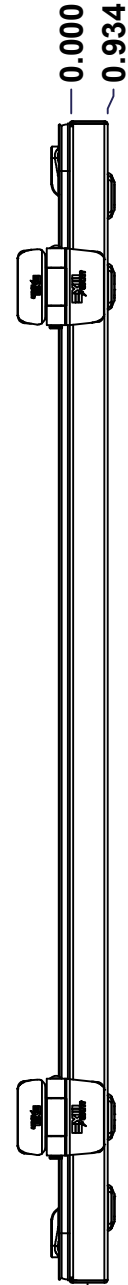

LEFT

0.000
0.934

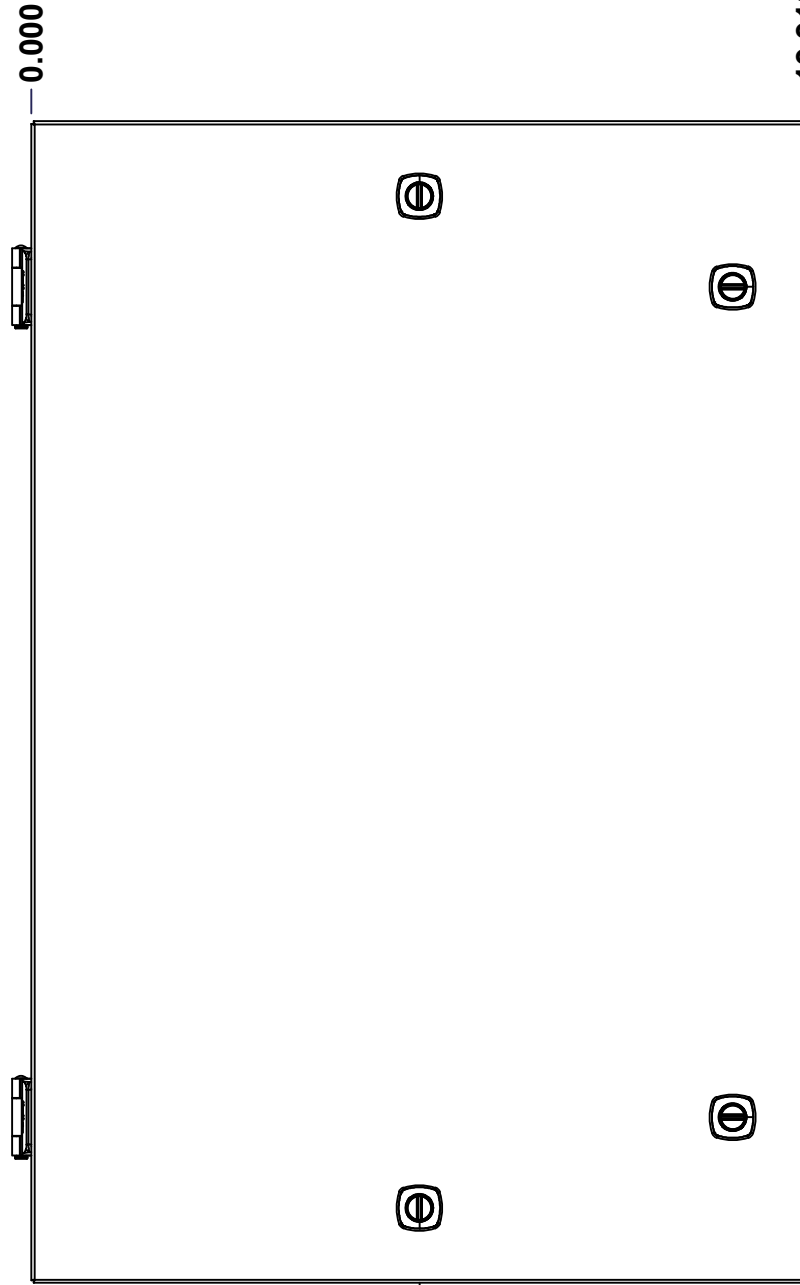

FRONT

0.000
19.918

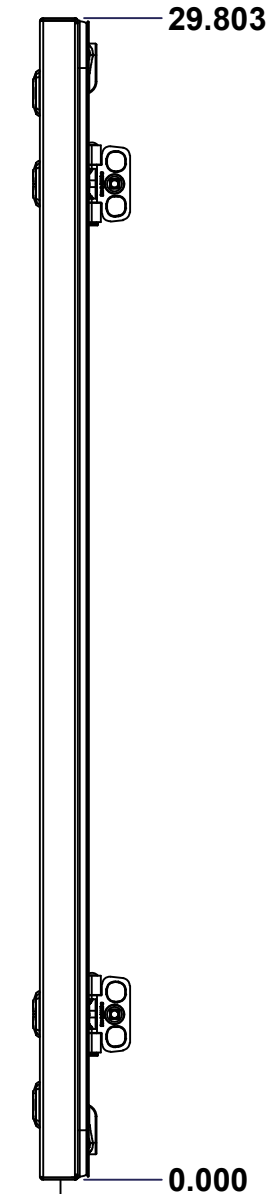

RIGHT

29.803

0.000

No.	Revisions	Date	By/Par

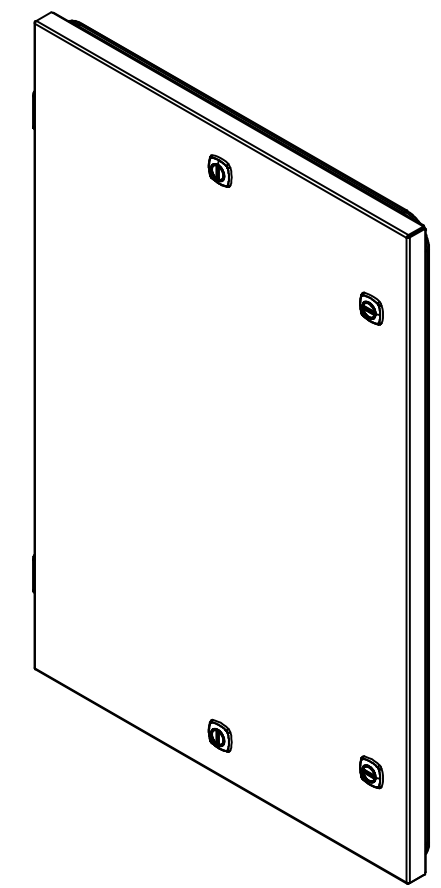

Isometric View

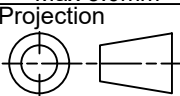

 Tél: (450) 979-4373 Fax: (450) 979-4626 www.exmweb.com	Flatness Aplatissement	Max 3.0mm
	Projection	
Customer Client	Date	
Drawn By Dessiné Par	BoxCad: BoxCad	Date 04-Dec-24
Material Matière	16 Ga Cold Rolled A1008 CS Type B (1.4mm)	
Color Couleur	Asa-61 Grey	Finish Fini Smooth
Description	5412ESDG 30" x 20" Cover	
Part Number Numéro Pièce	Rev. 0	7 9

SEE BILL OF MATERIAL ON LAST PAGE

5412ESDG302006C

This drawing is confidential and must not be reproduced or used without the consent of EXM

Ce dessin est confidentiel et ne doit pas être reproduit ou utilisé sans le consentement de EXM

STANDARD FEATURES ARE NOT LISTED IN THIS HOLE TABLE

HOLE TABLE - FRONT VIEW (CUSTOM FEATURE ONLY)

CUT-OUT	XDIM	YDIM	DESCRIPTION
1	2.000	2.000	GND STUD M6 x 16mm (Inside)
2	3.750	26.803	LABEL_EXM (Inside)
3	17.994	25.553	LOCK 880 SCQ4-SL @ 0.0°
4	17.994	4.250	LOCK 880 SCQ4-SL @ 0.0°
5	9.959	27.879	LOCK 880 SCQ4-SL @ 90.0°
6	9.959	1.924	LOCK 880 SCQ4-SL @ 270.0°

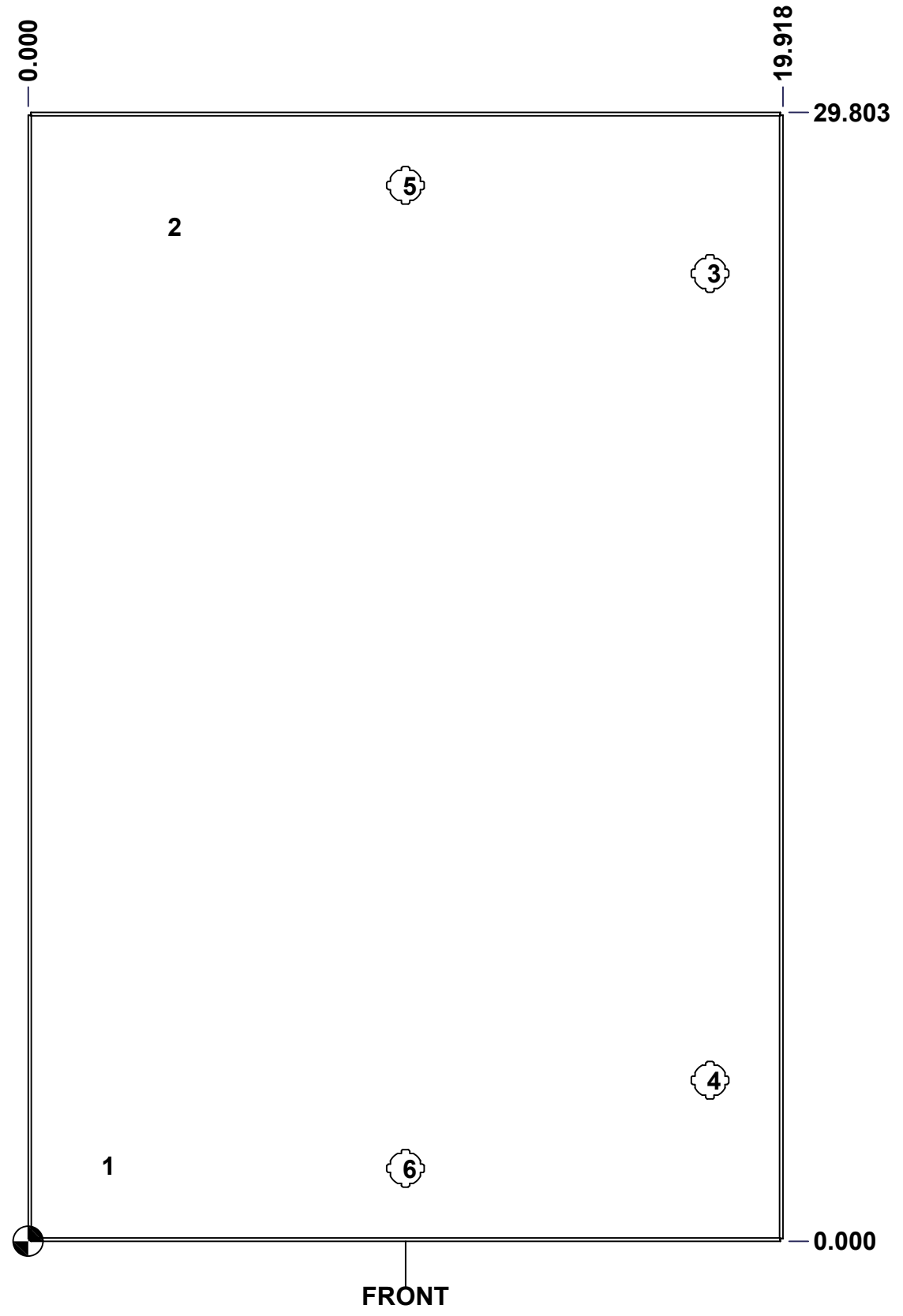

FRONT

	Description	Status	
	5412ESDG 30" x 20" Cover	(NULL)	
	Part Number Numéro Pièce	Rev.	
	5412ESDG302006C	0	8 9

This drawing is confidential and must not be reproduced or used without the consent of EXM

Ce dessin est confidentiel et ne doit pas être reproduit ou utilisé sans le consentement de EXM

No.	Revisions	Date	By/Par

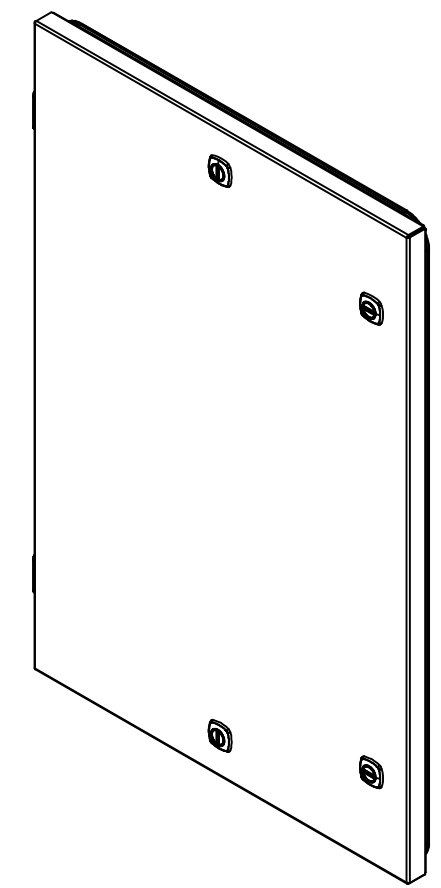

Isometric View



 Tél: (450) 979-4373
 Fax: (450) 979-4626
www.exmweb.com

Flatness / Aplatissement: Max 3.0mm
 Projection: 

QTY	Part Number	Rev	Description
4	STK-K-12500	19	5412 ES 1/4 Turn Lock
1	STK-S-00100	0	3.5" x 2" Silver Milar Flexcon Sticker
1	STK-Q-16080	0	Ground Stud M6 x 16mm Steel
1	STK-P-02400S	0	Powder Paint (Asa-61 Grey / Smooth)
1	5412ESDG302006G2	0	5412ESDG 30" x 20" Cover Gasket
1	5412ESDG302006G	0	5412ESDG 30" x 20" Cover Gasket
1	5412ESDG302006C-P	0	5412ESDG 30" x 20" Cover Part
2	STK-A-02360	0	External Hinge for Double Gasket
2	STK-Q-07220	1	M6 Nylon Insert Lock Nut
2	STK-Q-10252	0	M6 Stainless Steel Sealing Washer
Parts List			

Customer Client: _____ Date: _____

Drawn By / Dessiné Par: BoxCad: BoxCad Date: 04-Dec-24

Material / Matière: 16 Ga Cold Rolled A1008 CS Type B (1.4mm)

Color / Couleur: Asa-61 Grey Finish / Fini: Smooth

Description: 5412ESDG 30" x 20" Cover Detail Rev. _____

Part Number / Numéro Pièce: **5412ESDG302006C** Rev. **0** / 9

This drawing is confidential and must not be reproduced or used without the consent of EXM

Ce dessin est confidentiel et ne doit pas être reproduit ou utilisé sans le consentement de EXM

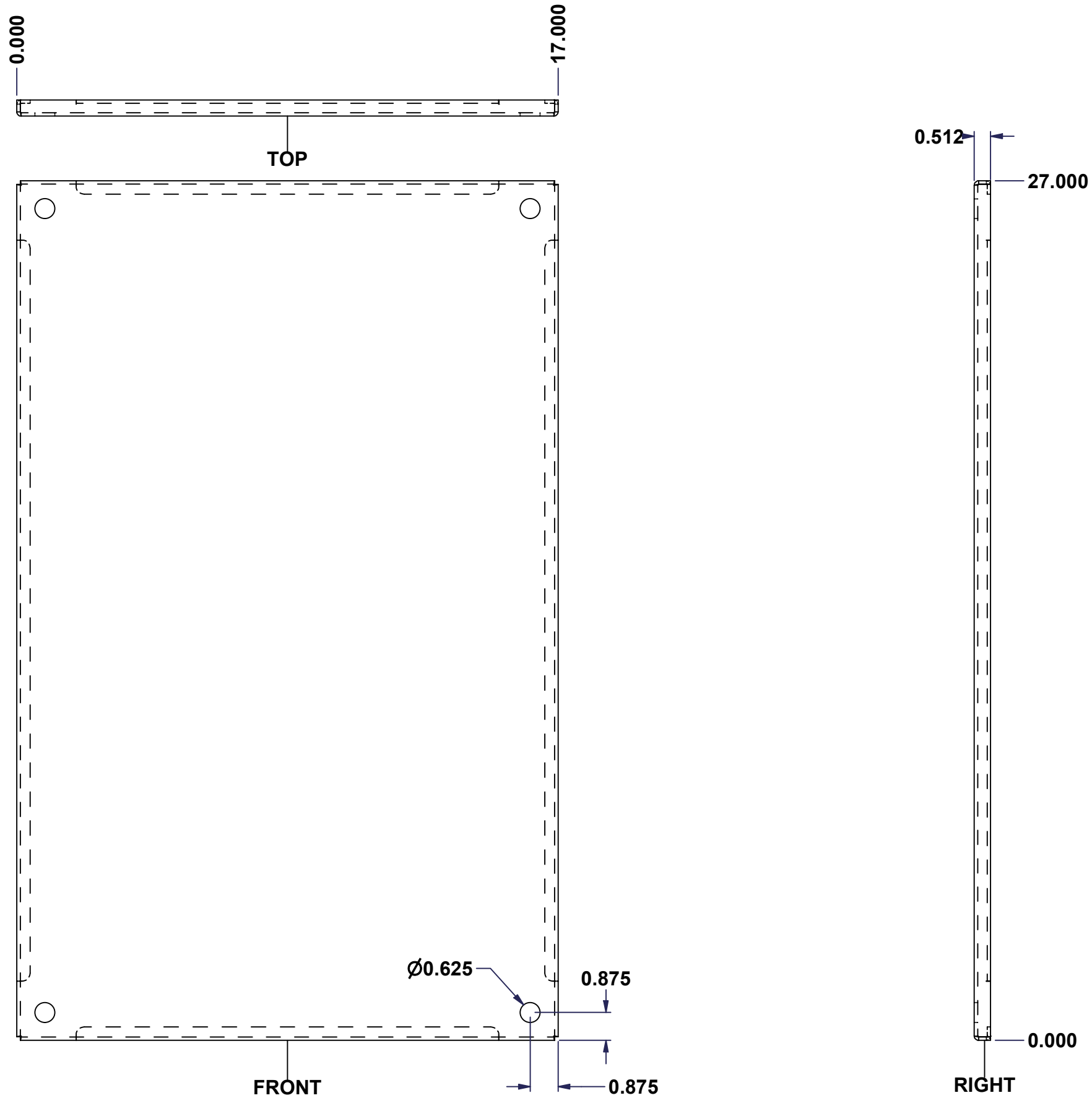

No.	Revisions	Date	By/Par

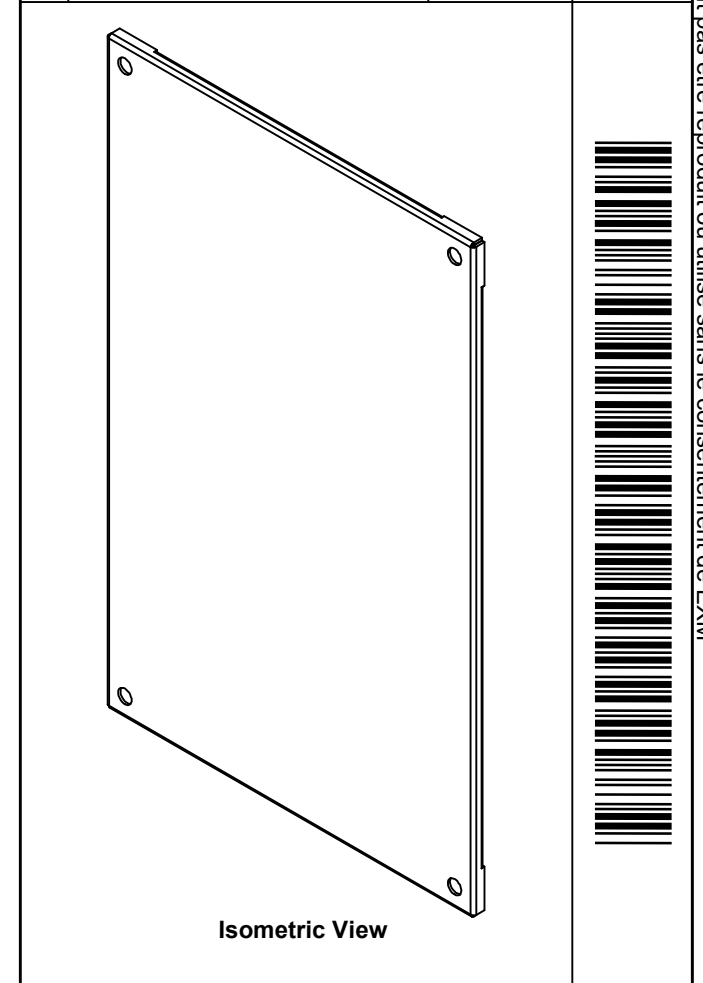

Tél: (450) 979-4373 Fax: (450) 979-4626 www.exmweb.com		Flatness Aplatissement Max 3.0mm Projection
Customer Client	Date	
Drawn By Dessiné Par	BoxCad: nickz	Date 01/03/2017
Material Matière	12 Ga Galvanized (2.5mm)	
Color Couleur	See Part List	Finish Fini See Part List
Description	Detail Rev.	
885SP 30" x 20" Inner Panel Part		
Part Number Numéro Pièce	Rev.	1
885SP3020G	0	1

Qty	Part Number	Rev	Description	Material	Color	Finish
1	885SP3020G-P	0	885SP 30" x 20" Inner Panel Part	12 Ga Galvanized (2.5mm)	Unpainted	Galvanized

Parts List