

This drawing is confidential and must not be reproduced or used without the consent of EXM

Ce dessin est confidentiel et ne doit pas être reproduit ou utilisé sans le consentement de EXM

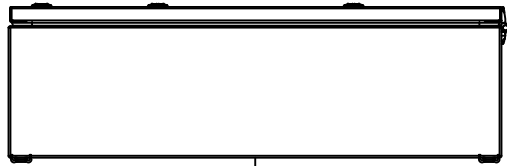

TOP

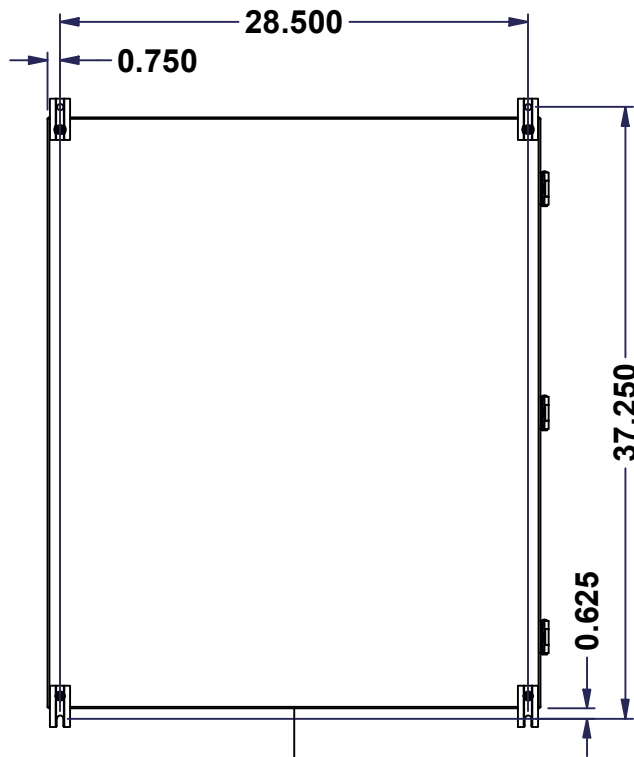

BACK

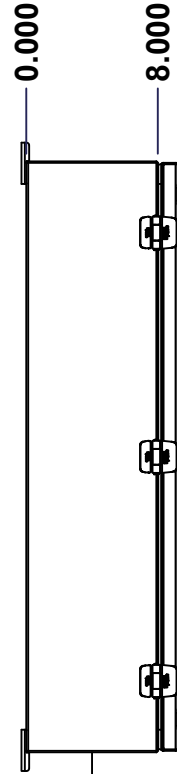

LEFT

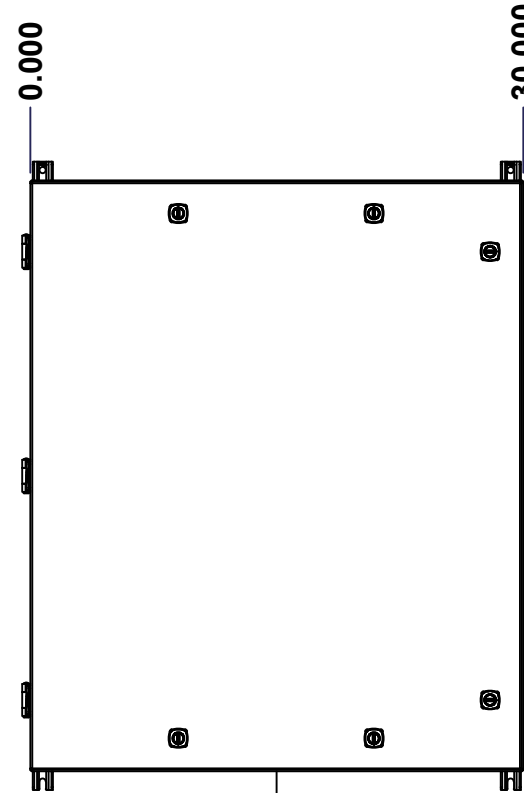

FRONT

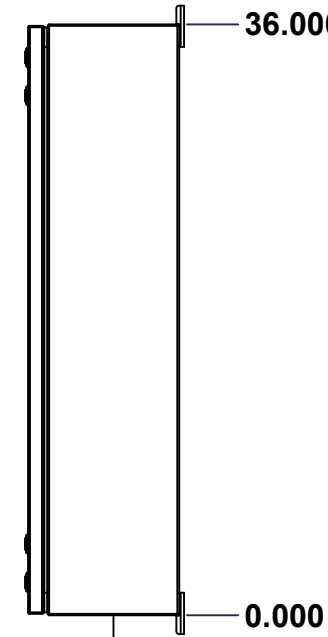

RIGHT

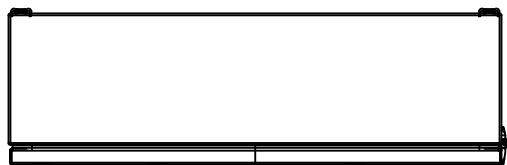

BOTTOM

No.	Revisions	Date	By/Par

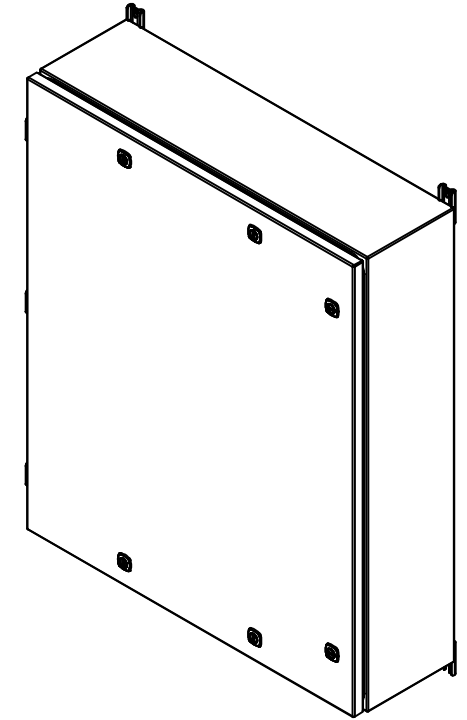

Isometric View



Tél: (450) 979-4373
 Fax: (450) 979-4626
www.exmweb.com

Flatness
Aplatissement

Max 3.0mm

Projection



Customer Client	Date
Drawn By / Dessiné Par: BoxCad: BoxCad	Date: 01-Jan-25
Material / Matière: 14 Ga Cold Rolled A1008 CS Type B (1.7mm)	

Color / Couleur: Asa-61 Grey	Finish / Fini: Smooth
------------------------------	-----------------------

Description: 5412ESDG 36" x 30" x 8" Assembly	Detail Rev.
---	-------------

Part Number / Numéro Pièce: 5412ESDG363008TH	Rev. 0	1
--	--------	---

SEE BILL OF MATERIAL ON LAST PAGE

This drawing is confidential and must not be reproduced or used without the consent of EXM

Ce dessin est confidentiel et ne doit pas être reproduit ou utilisé sans le consentement de EXM

NOTE	
ITEM	DESCRIPTION
1	NEMA 4, 12 Enclosure (IP66)
2	C/W Standard ground studs on box and cover
3	C/W Standard door stiffener
4	C/W Standard inner panel (Included)
5	C/W Standard inner panel mounting studs
6	C/W 885 ESMF3_OPEN Sold separately (Installed)
7	C/W 885 ESMF3_CLOSE Sold separately (Installed)
8	C/W R5 Insulation (Installed aluminum visible)

No.	Revisions	Date	By/Par

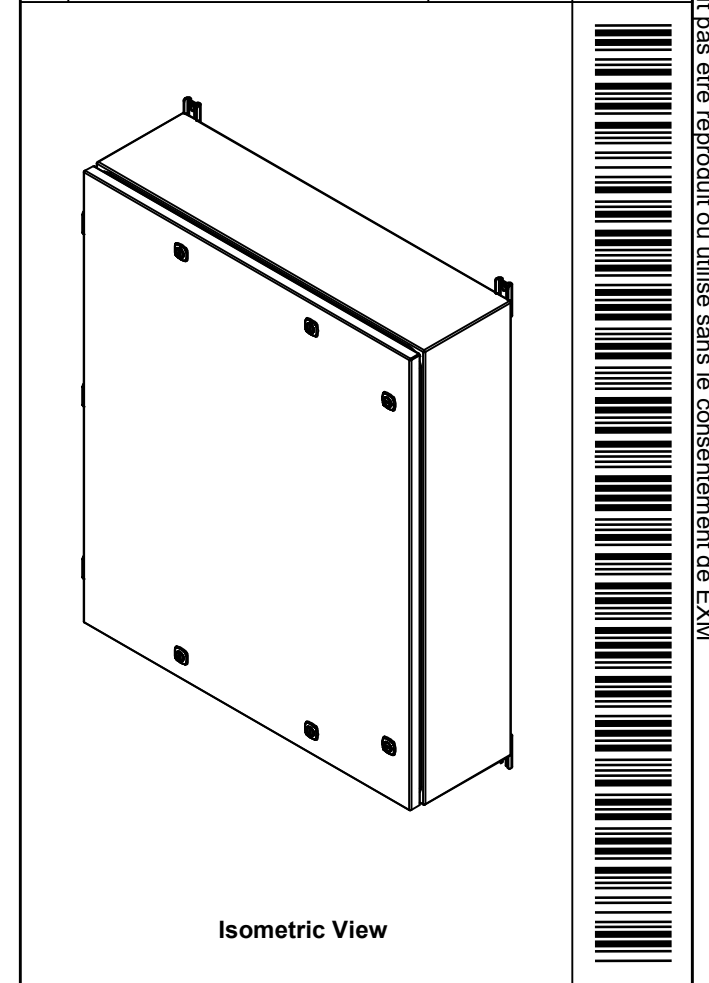



Tél: (450) 979-4373
Fax: (450) 979-4626
www.exmweb.com

Flatness
Aplatissement
Max 3.0mm

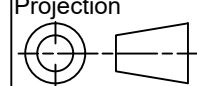
Projection

Customer Client	Date
Drawn By / Dessiné Par: BoxCad: BoxCad	Date: 01-Jan-25
Material / Matière: 14 Ga Cold Rolled A1008 CS Type B (1.7mm)	

PACKING		
ITEM	QTY	DESCRIPTION
Cardboard sleeve	2	Top and Bottom
Cardboard strip	2	Between back of enclosure and inner panel
Plastic bag	1	To protect cover surface and inside gasket
Plastic strap - Black	2	To Squeeze the 2 cardboard sleeve together
Packaging label	1	White label with product number

6	STK-Q-00600	2	M12 to M8 Adaptor
1	885SP3630G	0	885SP 36" x 30" Inner Panel Part
1	STK-K-01800	5	5412 ES Accessory Kit
3	STK-Q-10252	0	M6 Stainless Steel Sealing Washer
1	5412ESDG363008THC	0	5412ESDG 36" x 30" Cover
1	5412ESDG363008THB	0	5412ESDG 36" x 30" x 8" Body
3	STK-Q-07220	1	M6 Nylon Insert Lock Nut
Qty	Part Number	Rev	Description
Parts List			

Color / Couleur: Asa-61 Grey	Finish / Fini: Smooth
Description: 5412ESDG 36" x 30" x 8" Assembly	
Part Number / Numéro Pièce: 5412ESDG363008TH	Rev. 0
2 / 16	

This drawing is confidential and must not be reproduced or used without the consent of EXM

Ce dessin est confidentiel et ne doit pas être reproduit ou utilisé sans le consentement de EXM

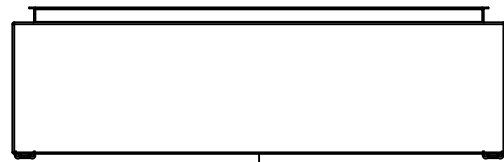

TOP

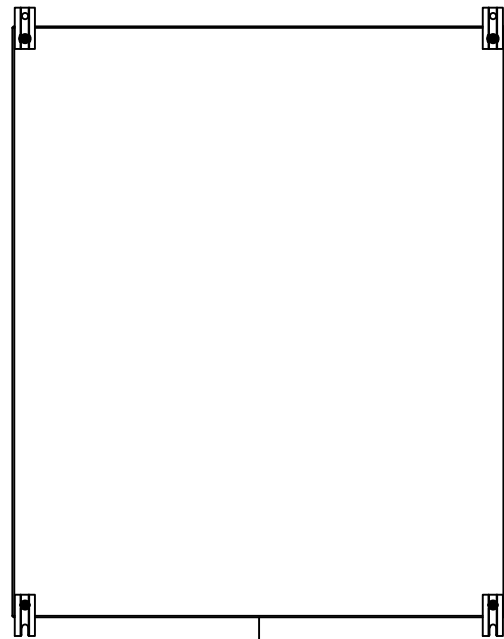

BACK

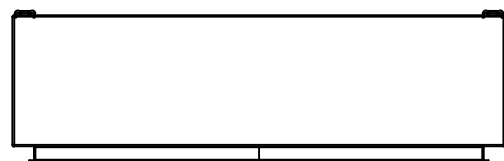

BOTTOM

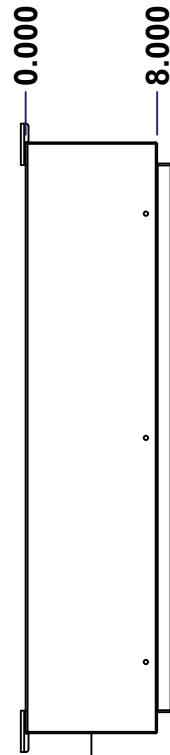

LEFT

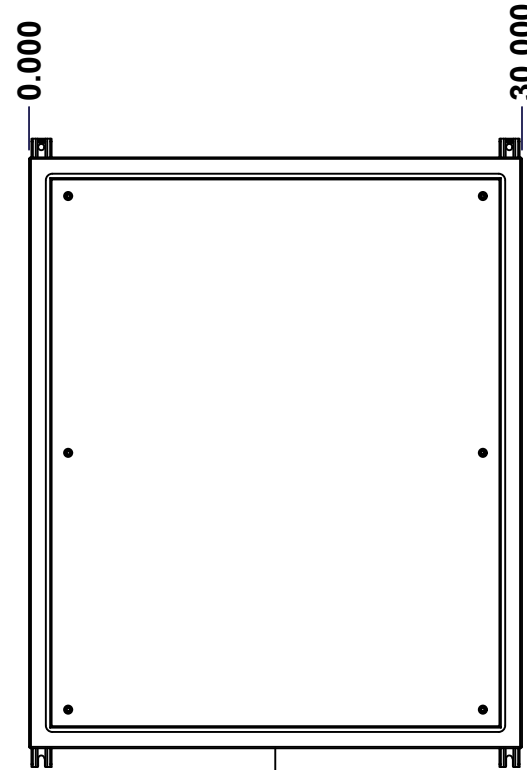

FRONT



RIGHT

No.	Revisions	Date	By/Par

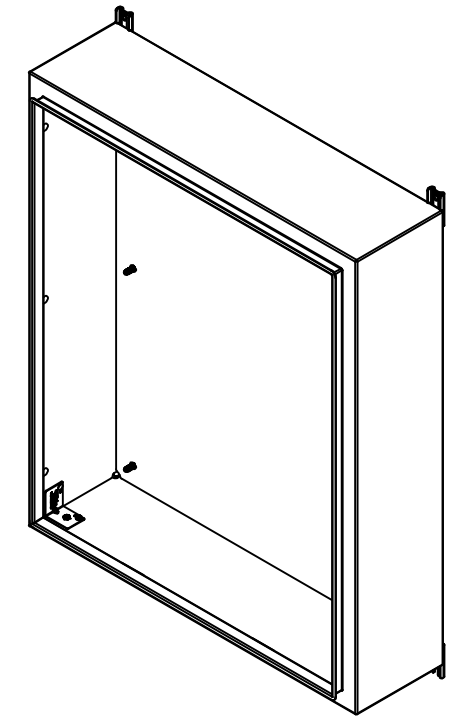

Isometric View

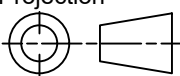

 Tél: (450) 979-4373 Fax: (450) 979-4626 www.exmweb.com		Flatness Aplatissement Max 3.0mm Projection 	
Customer Client		Date	
Drawn By Dessiné Par BoxCad: BoxCad		Date 01-Jan-25	
Material Matière 14 Ga Cold Rolled A1008 CS Type B (1.7mm)			
Color Couleur Asa-61 Grey		Finish Fini Smooth	
Description 5412ESDG 36" x 30" x 8" Body			Detail Rev.
Part Number Numéro Pièce		Rev.	3
SEE BILL OF MATERIAL ON LAST PAGE		0	16

SEE BILL OF MATERIAL ON LAST PAGE

5412ESDG363008THB

This drawing is confidential and must not be reproduced or used without the consent of EXM

Ce dessin est confidentiel et ne doit pas être reproduit ou utilisé sans le consentement de EXM

STANDARD FEATURES ARE NOT LISTED IN THIS HOLE TABLE			
HOLE TABLE - TOP VIEW (CUSTOM FEATURE ONLY)			
CUT-OUT	XDIM	YDIM	DESCRIPTION
1	2.000	6.500	INSUL. STUD M6 x 18mm (Inside)
2	28.000	6.500	INSUL. STUD M6 x 18mm (Inside)

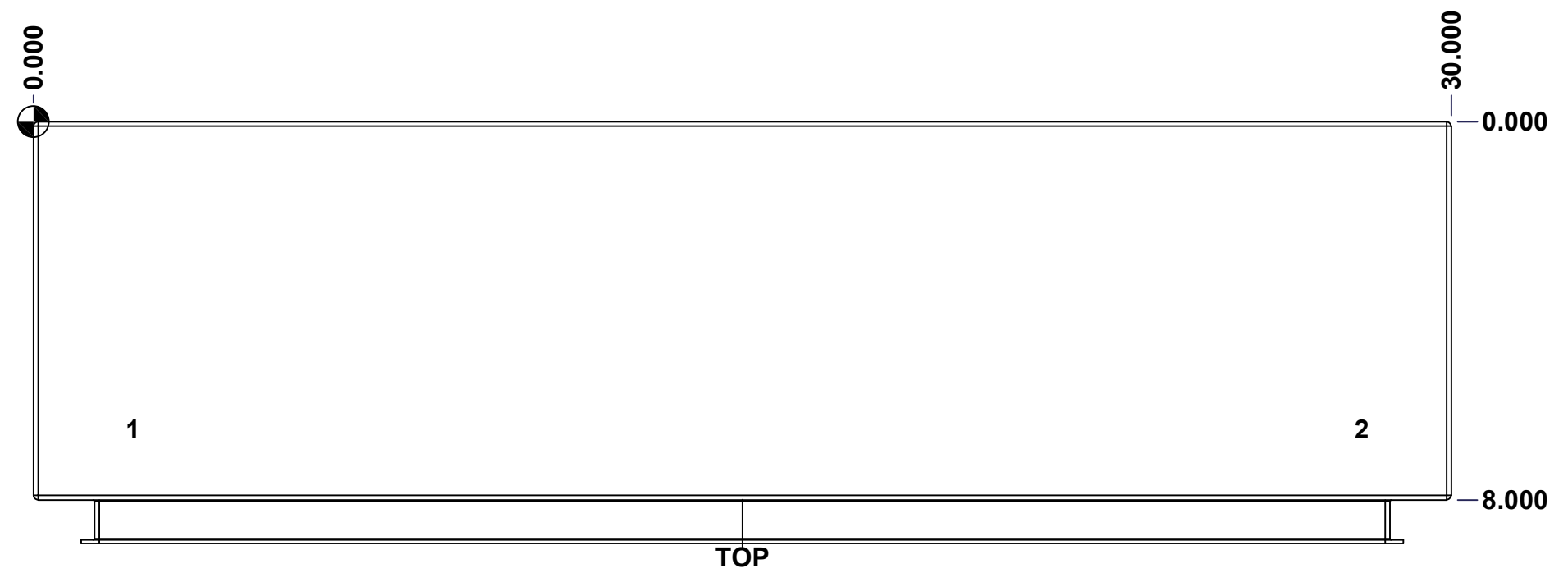

	Description	Status
	5412ESDG 36" x 30" x 8" Body	(NULL)
	Part Number Numéro Pièce	Rev.
	5412ESDG363008THB	0
		4
		16

This drawing is confidential and must not be reproduced or used without the consent of EXM

Ce dessin est confidentiel et ne doit pas être reproduit ou utilisé sans le consentement de EXM

STANDARD FEATURES ARE NOT LISTED IN THIS HOLE TABLE			
HOLE TABLE - BOTTOM VIEW (CUSTOM FEATURE ONLY)			
CUT-OUT	XDIM	YDIM	DESCRIPTION
1	2.000	6.500	INSUL. STUD M6 x 18mm (Inside)
2	28.000	6.500	INSUL. STUD M6 x 18mm (Inside)

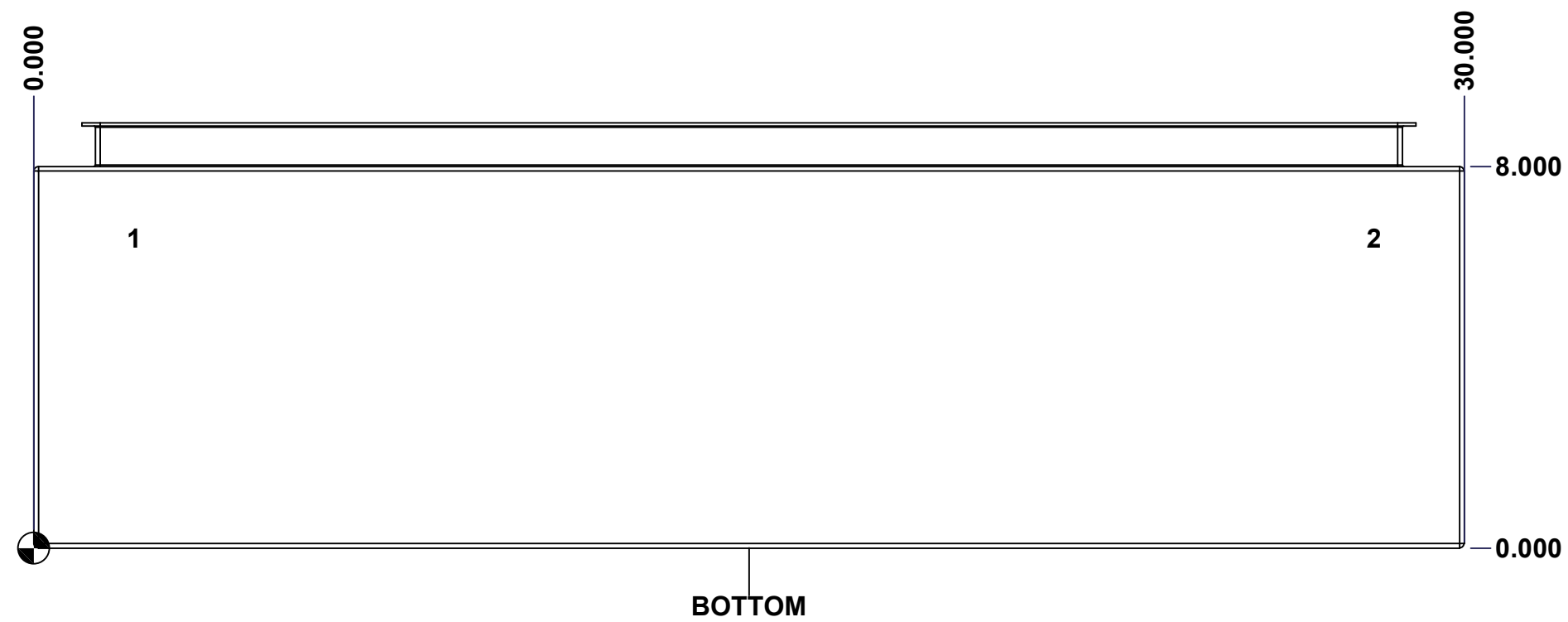

	Description	Status
	5412ESDG 36" x 30" x 8" Body	(NULL)
	Part Number Numéro Pièce	Rev.
	5412ESDG363008THB	0 / 5
		16

This drawing is confidential and must not be reproduced or used without the consent of EXM

Ce dessin est confidentiel et ne doit pas être reproduit ou utilisé sans le consentement de EXM

STANDARD FEATURES ARE NOT LISTED IN THIS HOLE TABLE

HOLE TABLE - BACK VIEW (CUSTOM FEATURE ONLY)

CUT-OUT	XDIM	YDIM	DESCRIPTION
1	2.375	2.375	IP STUD M8 x 35mm (Inside)
2	2.375	33.625	IP STUD M8 x 35mm (Inside)
3	27.625	33.625	IP STUD M8 x 35mm (Inside)
4	27.625	2.375	IP STUD M8 x 35mm (Inside)
5	2.375	18.000	IP STUD M8 x 35mm (Inside)
6	27.625	18.000	IP STUD M8 x 35mm (Inside)

7	29.250	0.000	FOOT 885 ESMF3_OPEN
8	0.750	0.000	FOOT 885 ESMF3_OPEN
9	29.250	36.000	FOOT 885 ESMF3_CLOSE
10	0.750	36.000	FOOT 885 ESMF3_CLOSE

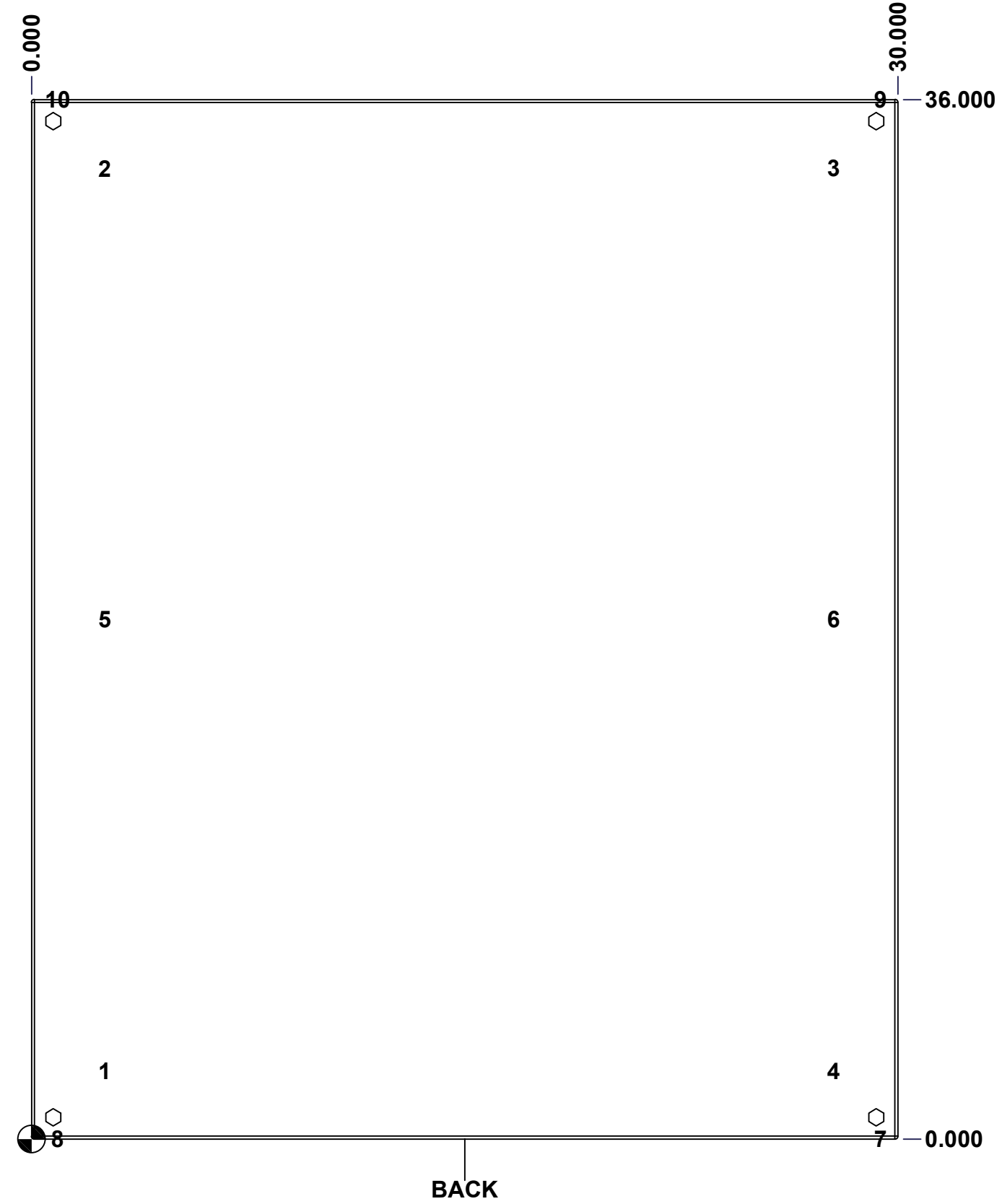

BACK

	Description	Status
	5412ESDG 36" x 30" x 8" Body	(NULL)
	Part Number Numéro Pièce	Rev.
	5412ESDG363008THB	6
		0
		16

This drawing is confidential and must not be reproduced or used without the consent of EXM

Ce dessin est confidentiel et ne doit pas être reproduit ou utilisé sans le consentement de EXM

No.	Revisions	Date	By/Par

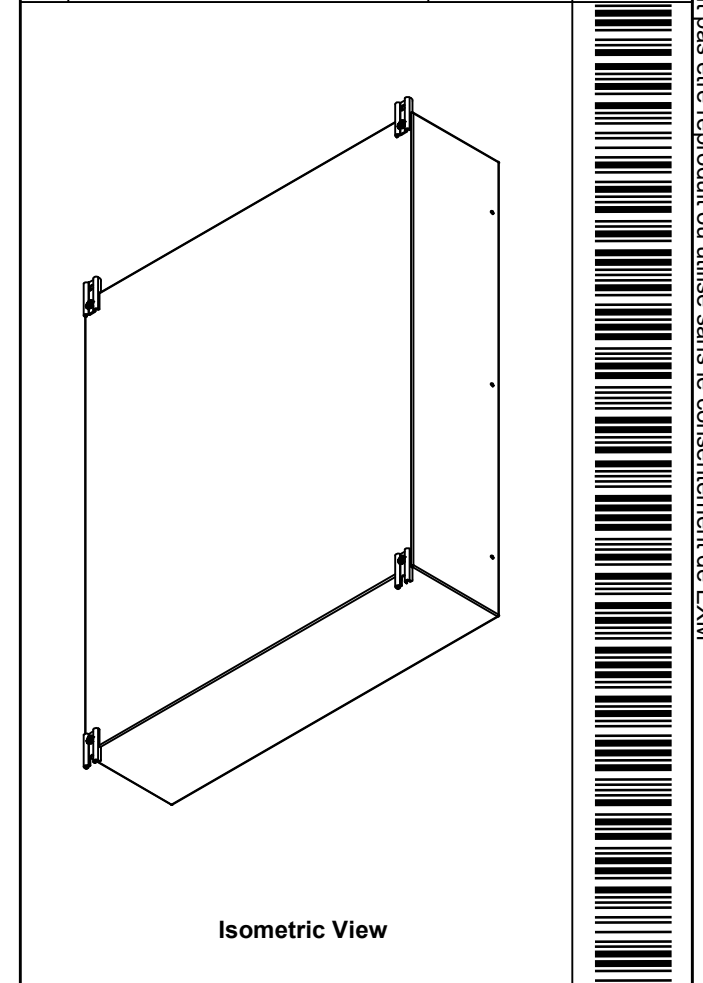

Isometric View

1	885 ESMF3	0	885 ESMF3 Mounting Foot Kit
4	RIVET_NUT_M10_FH_CE	0	Rivet Nut M10 (Low Profile Close End)
1	STK-K-70554	3	5412 ESTH Accessory Kit
1	5412ESDG363008THI-RS	0	5412ESDG 36" x 30" Right Insulation
1	5412ESDG363008THI-LS	0	5412ESDG 36" x 30" Left Insulation
1	5412ESDG363008THI-BT	0	5412ESDG 36" x 30"Bottom Insulation
1	5412ESDG363008THI-TP	0	5412ESDG 36" x 30"Top Insulation
1	5412ESDG363008THI-B	0	5412ESDG 36" x 30" Back Insulation
4	STK-Q-16055	1	M6 x 18mm Stud (No Paint Cap Required)
1	STK-P-02400S	0	Powder Paint (Asa-61 Grey / Smooth)
6	STK-Q-16005	0	Stud M8 x 35mm Steel
1	5412ESDG363008THB-P	0	5412ESDG 36" x 30" x 8" Body Part
Qty	Part Number	Rev	Description
Parts List			

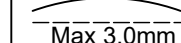
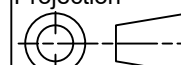
 Tél: (450) 979-4373 Fax: (450) 979-4626 www.exmweb.com		Flatness Aplatissement  Max 3.0mm
Projection 		Customer Client
Drawn By Dessiné Par BoxCad: BoxCad		Date 01-Jan-25
Material Matière 14 Ga Cold Rolled A1008 CS Type B (1.7mm)		
Color Couleur Asa-61 Grey	Finish Fini Smooth	
Description 5412ESDG 36" x 30" x 8" Body		Detail Rev.
Part Number Numéro Pièce 5412ESDG363008THB		Rev. 7 0

This drawing is confidential and must not be reproduced or used without the consent of EXM

Ce dessin est confidentiel et ne doit pas être reproduit ou utilisé sans le consentement de EXM



TOP

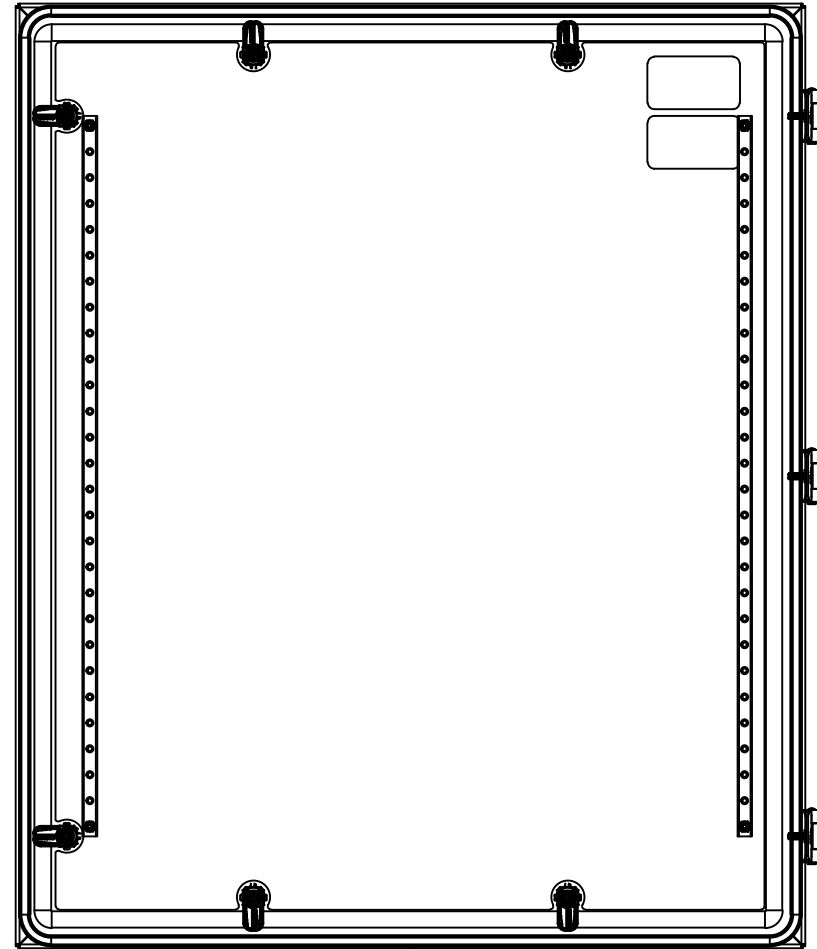

BACK

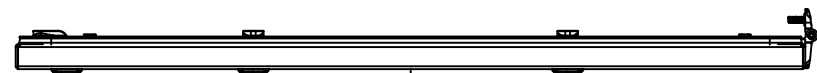

BOTTOM

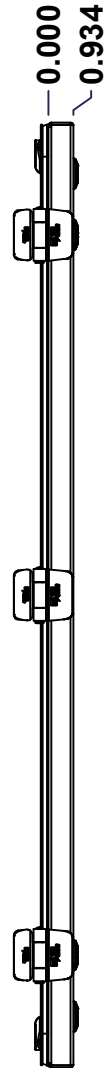

LEFT

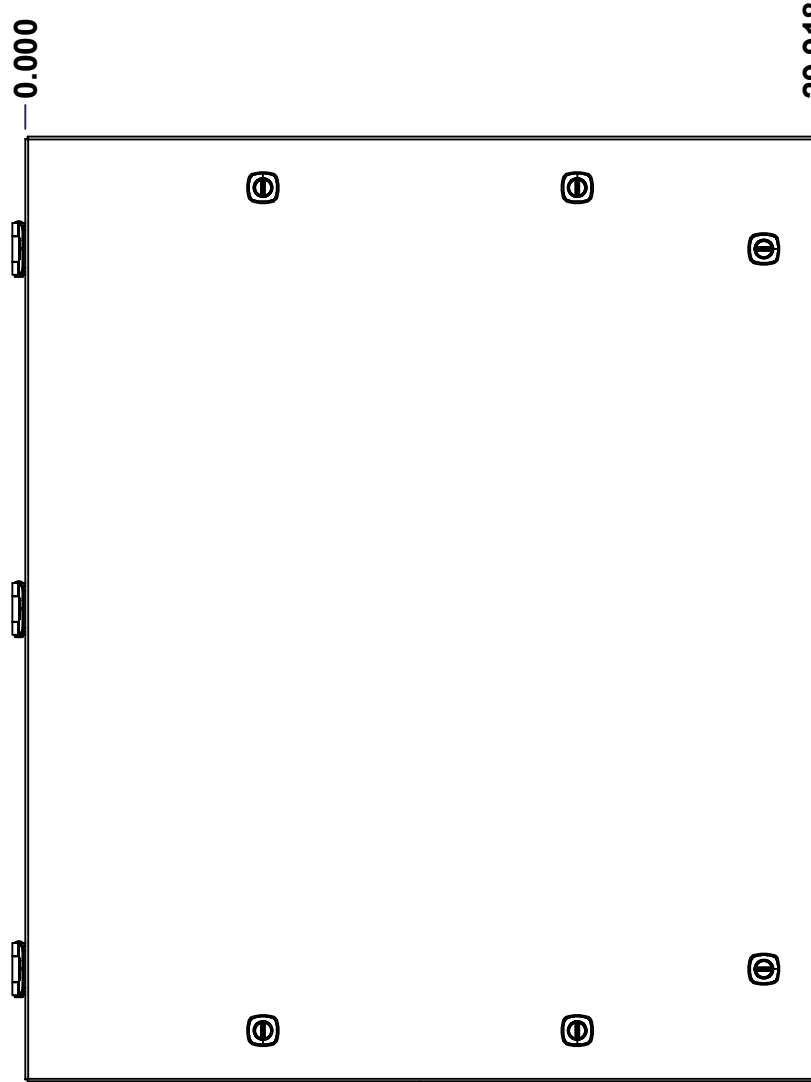

FRONT

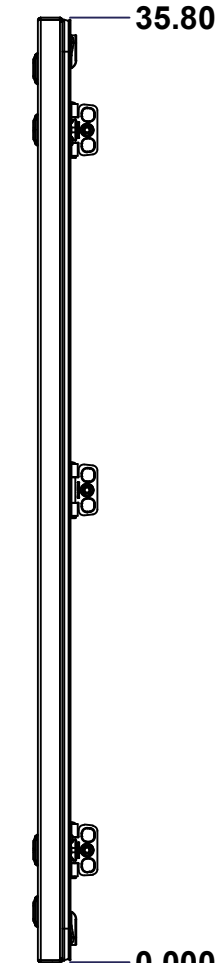

RIGHT

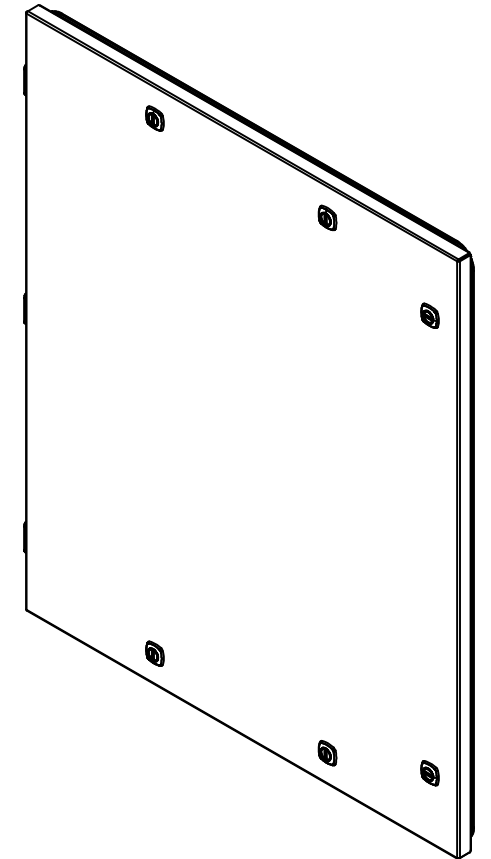

Isometric View

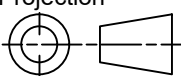

No.	Revisions	Date	By/Par

 Tél: (450) 979-4373 Fax: (450) 979-4626 www.exmweb.com		Flatness Aplatissement Max 3.0mm Projection 
Customer Client	Date	
Drawn By Dessiné Par	BoxCad: BoxCad	Date 01-Jan-25
Material Matière	14 Ga Cold Rolled A1008 CS Type B (1.7mm)	
Color Couleur	Asa-61 Grey	Finish Fini Smooth
Description 5412ESDG 36" x 30" Cover		Detail Rev.
Part Number Numéro Pièce	Rev. 0	8 / 16

SEE BILL OF MATERIAL ON LAST PAGE

5412ESDG363008THC

This drawing is confidential and must not be reproduced or used without the consent of EXM

Ce dessin est confidentiel et ne doit pas être reproduit ou utilisé sans le consentement de EXM

STANDARD FEATURES ARE NOT LISTED IN THIS HOLE TABLE

HOLE TABLE - FRONT VIEW (CUSTOM FEATURE ONLY)

CUT-OUT	XDIM	YDIM	DESCRIPTION
1	2.286	4.614	STUD M6 x 18mm (Inside)
2	2.286	31.189	STUD M6 x 18mm (Inside)
3	27.117	31.189	STUD M6 x 18mm (Inside)
4	27.117	4.614	STUD M6 x 18mm (Inside)

5	27.994	31.553	LOCK 880 SCQ4-SL @ 0.0°
6	27.994	4.250	LOCK 880 SCQ4-SL @ 0.0°
7	9.000	33.879	LOCK 880 SCQ4-SL @ 90.0°
8	20.918	33.879	LOCK 880 SCQ4-SL @ 90.0°
9	9.000	1.924	LOCK 880 SCQ4-SL @ 270.0°
10	20.918	1.924	LOCK 880 SCQ4-SL @ 270.0°

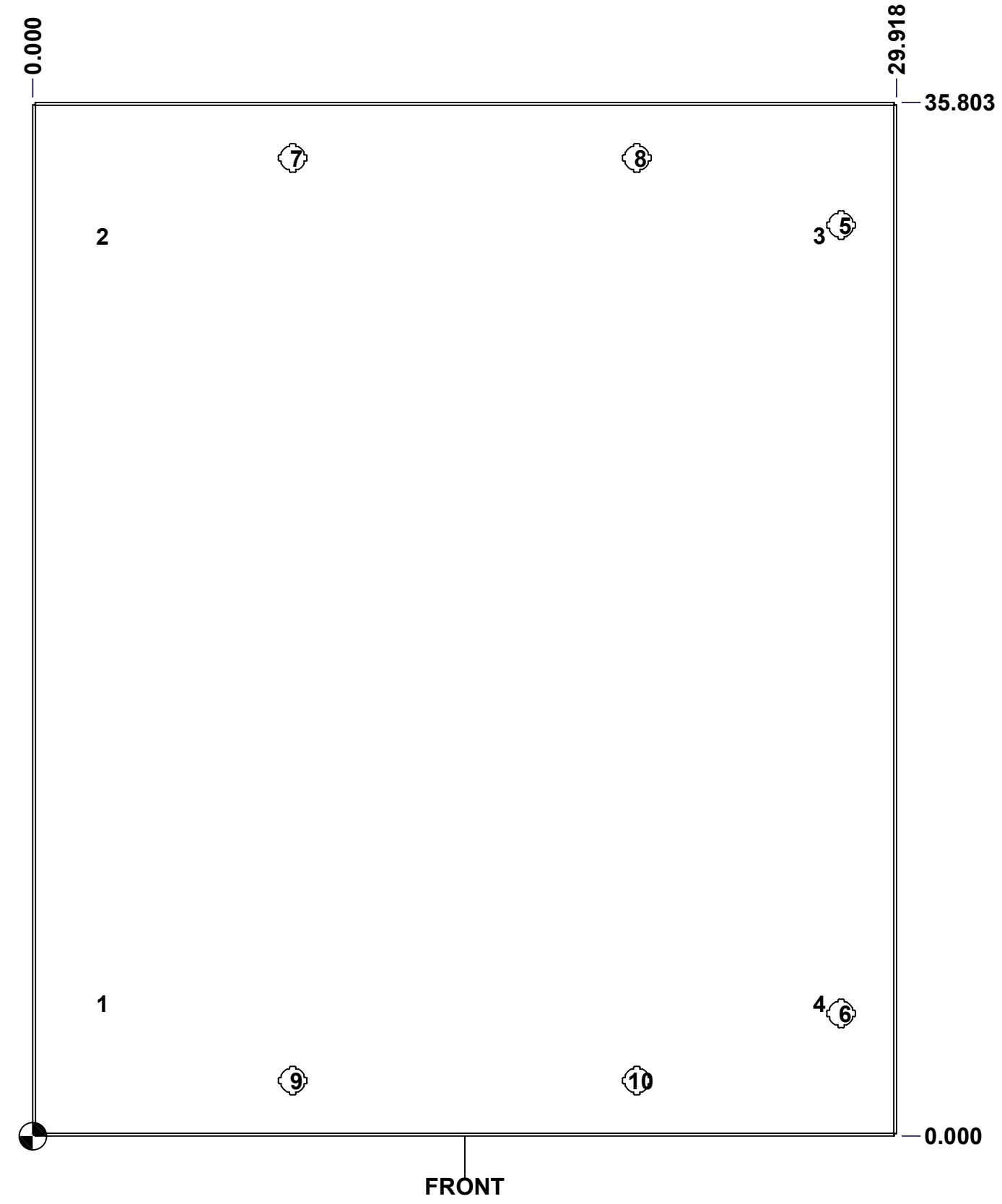

FRONT

	Description	Status
	5412ESDG 36" x 30" Cover	(NULL)
	Part Number Numéro Pièce	Rev.
	5412ESDG363008THC	0 / 9
		16

This drawing is confidential and must not be reproduced or used without the consent of EXM

Ce dessin est confidentiel et ne doit pas être reproduit ou utilisé sans le consentement de EXM

No.	Revisions	Date	By/Par

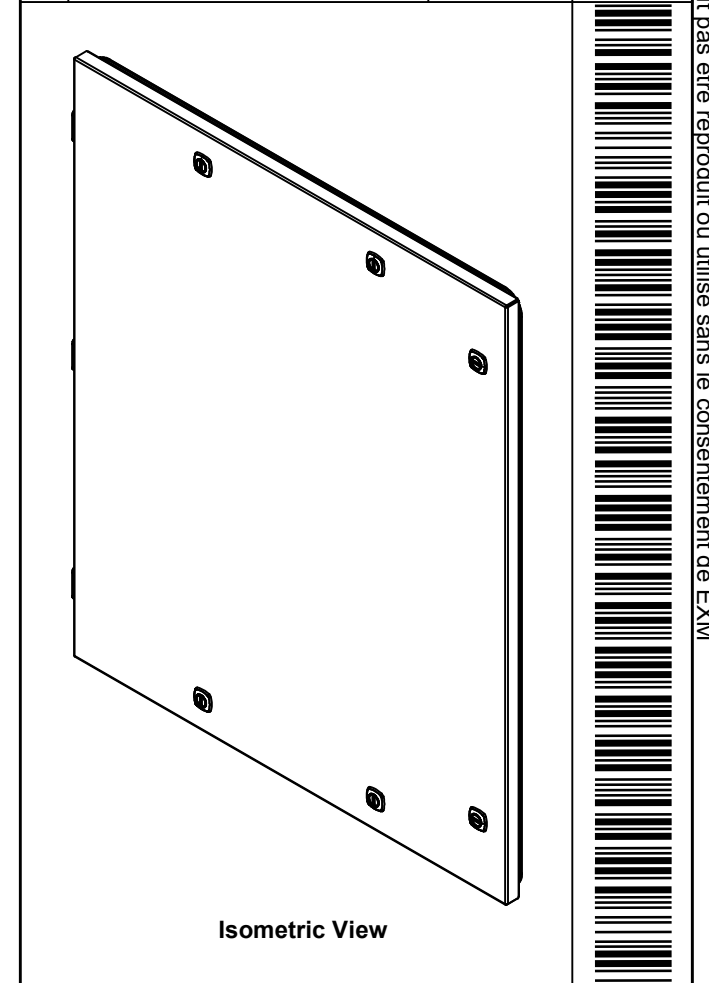

6	STK-K-12500	19	5412 ES 1/4 Turn Lock
2	STK-S-00100	0	3.5" x 2" Silver Milar Flexcon Sticker
4	STK-Q-07250	2	M6 x 16mm Collar Nut
2	STK-Q-46020-30	6	5412 ES Vertical Door Stiffener 30"
1	5412ESDG363008THI-C	0	5412ESDG 36" x 30" Cover Insulation
1	STK-P-02400S	0	Powder Paint (Asa-61 Grey / Smooth)
4	STK-Q-16055	1	M6 x 18mm Stud (No Paint Cap Required)
1	5412ESDG363008THG2	0	5412ESDG 36" x 30" Cover Gasket
1	5412ESDG363008THG	0	5412ESDG 36" x 30" Cover Gasket
1	5412ESDG363008THC-P	0	5412ESDG 36" x 30" Cover Part
3	STK-A-02360	0	External Hinge for Double Gasket
3	STK-Q-07220	1	M6 Nylon Insert Lock Nut
3	STK-Q-10252	0	M6 Stainless Steel Sealing Washer
QTY	Part Number	Rev	Description
Parts List			

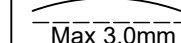
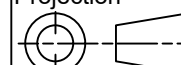
 Tél: (450) 979-4373 Fax: (450) 979-4626 www.exmweb.com		Flatness Aplatissement  Max 3.0mm
Projection 		Customer Client
Drawn By Dessiné Par BoxCad: BoxCad		Date 01-Jan-25
Material Matière 14 Ga Cold Rolled A1008 CS Type B (1.7mm)		
Color Couleur Asa-61 Grey	Finish Fini Smooth	
Description 5412ESDG 36" x 30" Cover		Detail Rev.
Part Number Numéro Pièce 5412ESDG363008THC		Rev. 10 0 16

This drawing is confidential and must not be reproduced or used without the consent of EXM

Ce dessin est confidentiel et ne doit pas être reproduit ou utilisé sans le consentement de EXM

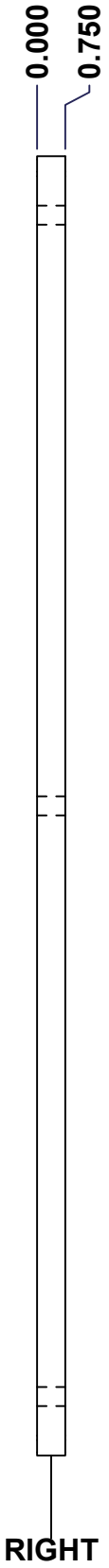
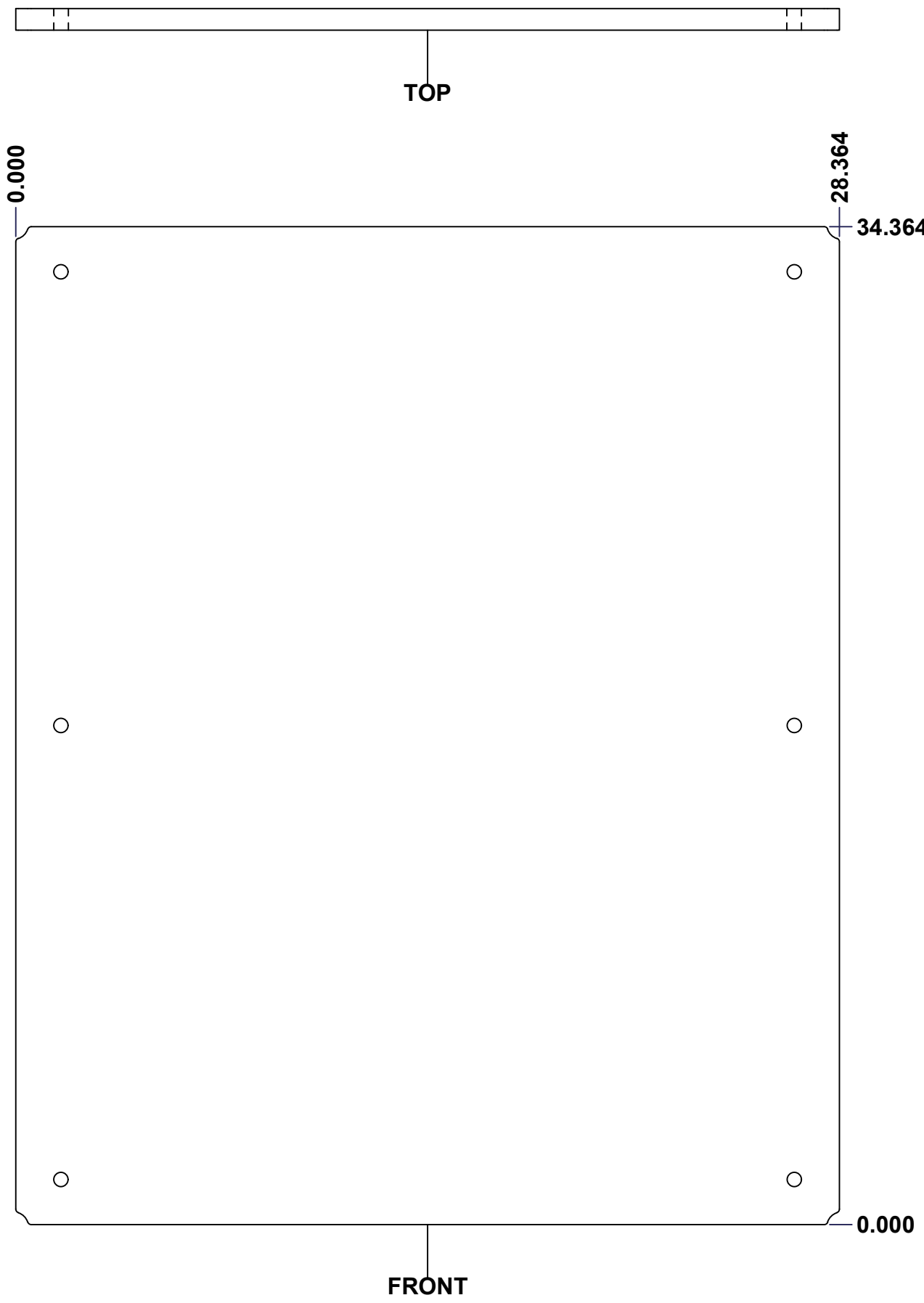

No.	Revisions	Date	By/Par

Isometric View

Tél: (450) 979-4373 Fax: (450) 979-4626 www.exmweb.com		Flatness Aplatissement
		Max 3.0mm
Projection		
Customer Client	Date	
Drawn By Dessiné Par	BoxCad: Patrick Deschenes	Date 23-Jan-07
Material Matière	Polyisocyanurate	
Color Couleur	Aluminum	Finish Fini N/A
Description	Detail Rev.	
5412ESDG 36" x 30" Back Insulation		
Part Number Numéro Pièce	Rev.	11
5412ESDG363008THI-B	0	16

SEE BILL OF MATERIAL ON LAST PAGE

This drawing is confidential and must not be reproduced or used without the consent of EXM

Ce dessin est confidentiel et ne doit pas être reproduit ou utilisé sans le consentement de EXM

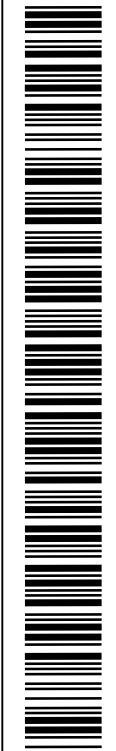
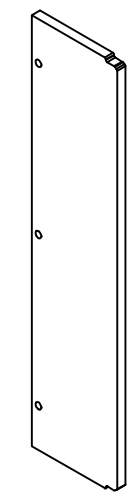
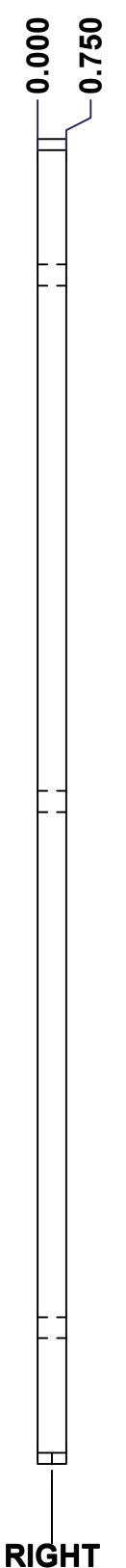
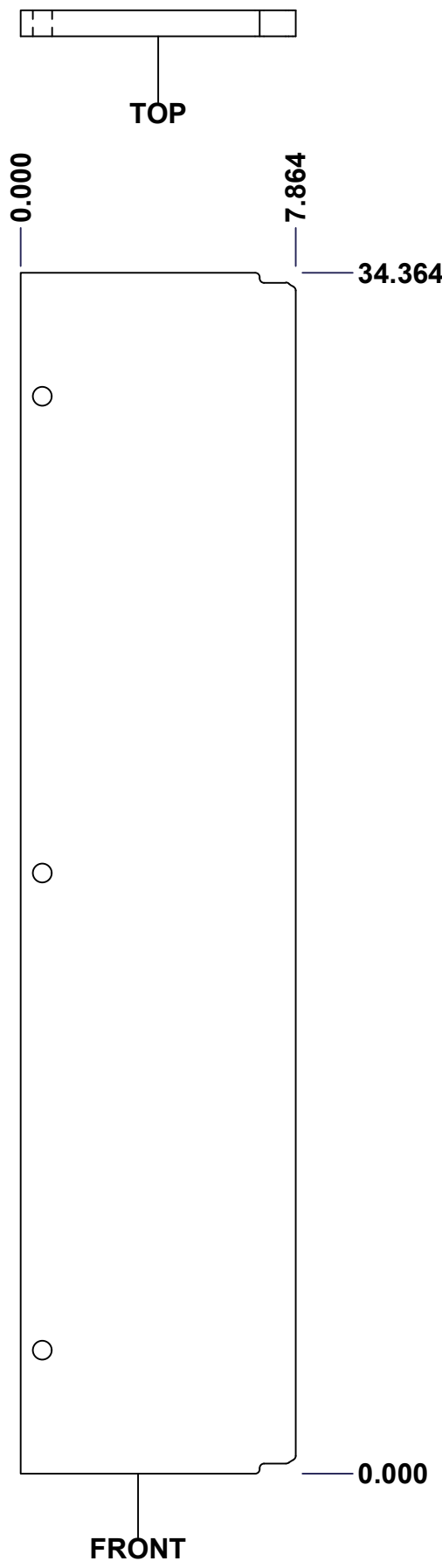

No.	Revisions	Date	By/Par

Isometric View



Tél: (450) 979-4373
 Fax: (450) 979-4626
www.exmweb.com

Flatness
 Aplatissement
 Max 3.0mm
 Projection

Customer Client	Date
Drawn By / Dessiné Par: BoxCad: Patrick Deschenes	Date: 23-Jan-07
Material / Matière: Polyisocyanurate	
Color / Couleur: Aluminum	Finish / Fini: N/A
Description: 5412ESDG 36" x 30" Left Insulation	Detail Rev.
Part Number / Numéro Pièce: 5412ESDG363008THI-LS	Rev. 0
	12 / 16

SEE BILL OF MATERIAL ON LAST PAGE

This drawing is confidential and must not be reproduced or used without the consent of EXM

Ce dessin est confidentiel et ne doit pas être reproduit ou utilisé sans le consentement de EXM

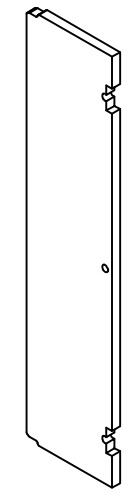
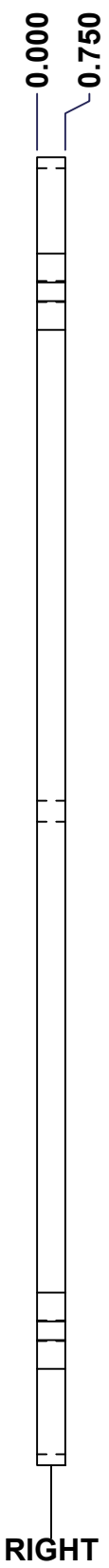
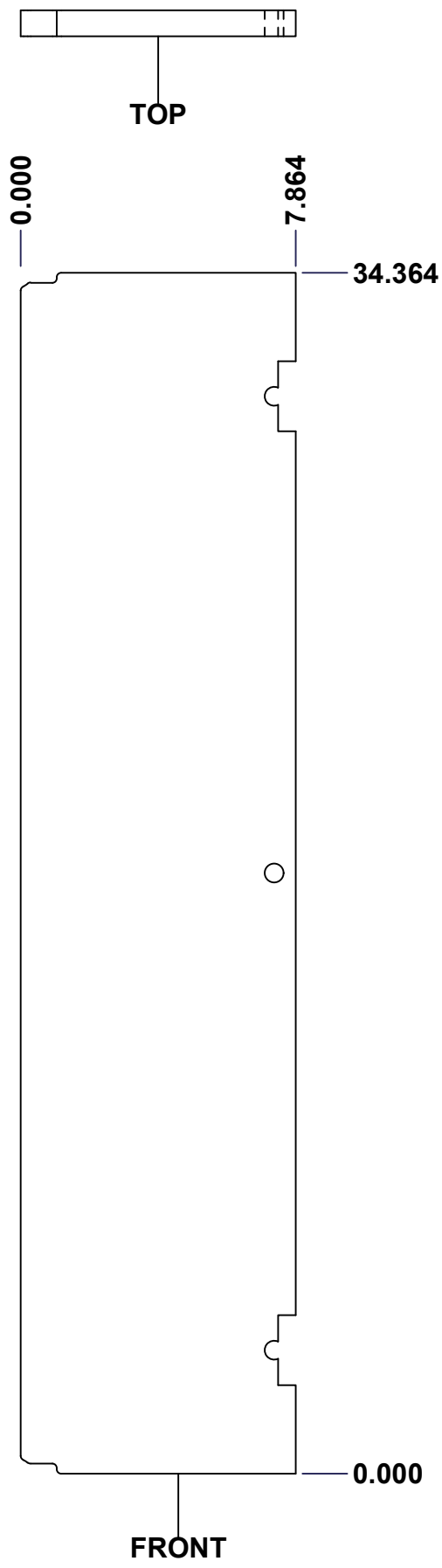

No.	Revisions	Date	By/Par

Isometric View



Tél: (450) 979-4373
 Fax: (450) 979-4626
www.exmweb.com

Flatness
Aplatissement
Max 3.0mm
Projection

Customer Client	Date
Drawn By / Dessiné Par: BoxCad: Patrick Deschenes	Date: 23-Jan-07
Material / Matière: Polyisocyanurate	
Color / Couleur: Aluminum	Finish / Fini: N/A

Description: 5412ESDG 36" x 30" Right Insulation
 Detail Rev.

Part Number / Numéro Pièce: 5412ESDG363008THI-RS	Rev. 0	13 / 16
--	--------	---------

SEE BILL OF MATERIAL ON LAST PAGE

This drawing is confidential and must not be reproduced or used without the consent of EXM

Ce dessin est confidentiel et ne doit pas être reproduit ou utilisé sans le consentement de EXM

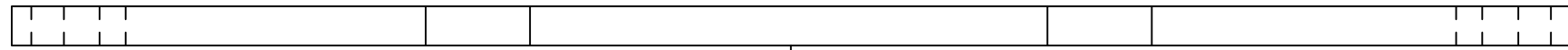

TOP

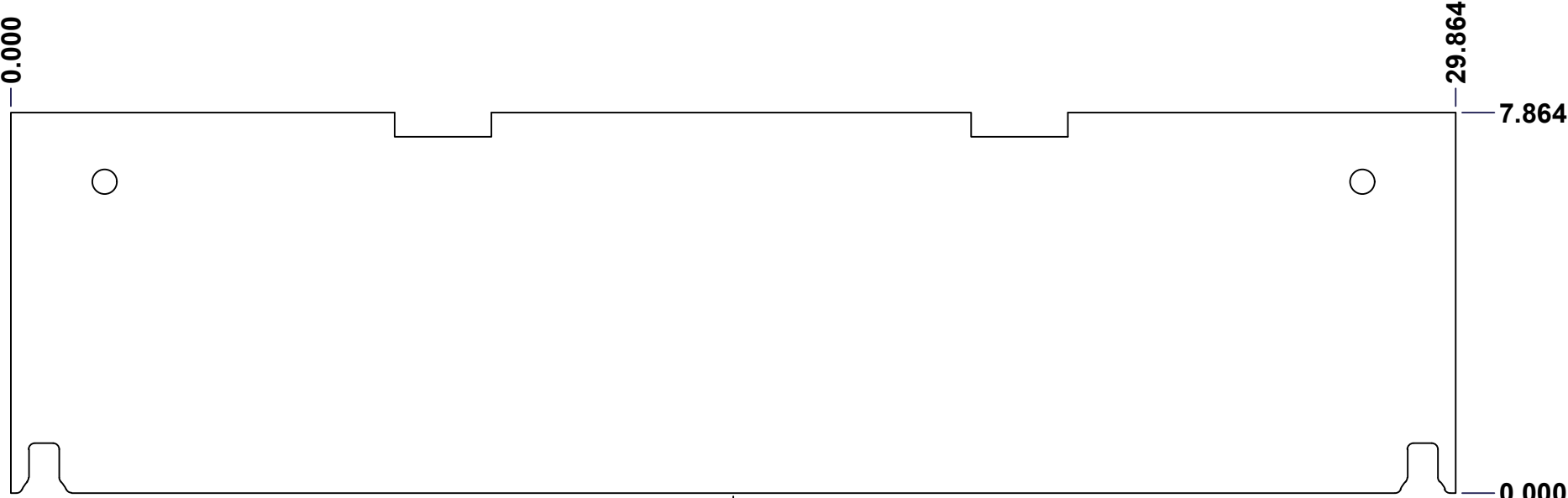

FRONT

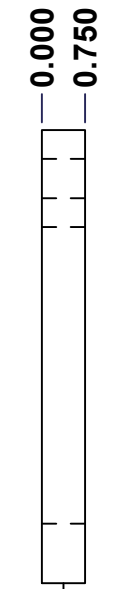

RIGHT

No.	Revisions	Date	By/Par

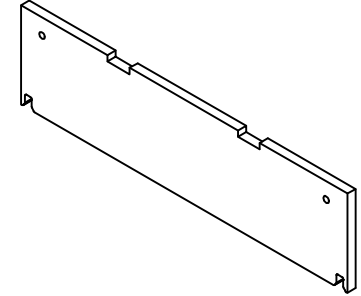

Isometric View



Tél: (450) 979-4373
 Fax: (450) 979-4626
www.exmweb.com

Flatness
Aplatissement
Max 3.0mm
Projection

Customer Client	Date
Drawn By / Dessiné Par: BoxCad: BoxCad	Date: 4/3/2024
Material / Matière: Polyisocyanurate	
Color / Couleur: Aluminum	Finish / Fini: Smooth
Description: 5412ESDG 36" x 30"Top Insulation	Detail Rev.
Part Number / Numéro Pièce: 5412ESDG363008THI-TP	Rev. 14
SEE BILL OF MATERIAL ON LAST PAGE	0

SEE BILL OF MATERIAL ON LAST PAGE

5412ESDG363008THI-TP

Rev. 14
0

This drawing is confidential and must not be reproduced or used without the consent of EXM

Ce dessin est confidentiel et ne doit pas être reproduit ou utilisé sans le consentement de EXM

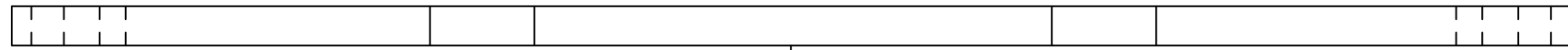

TOP

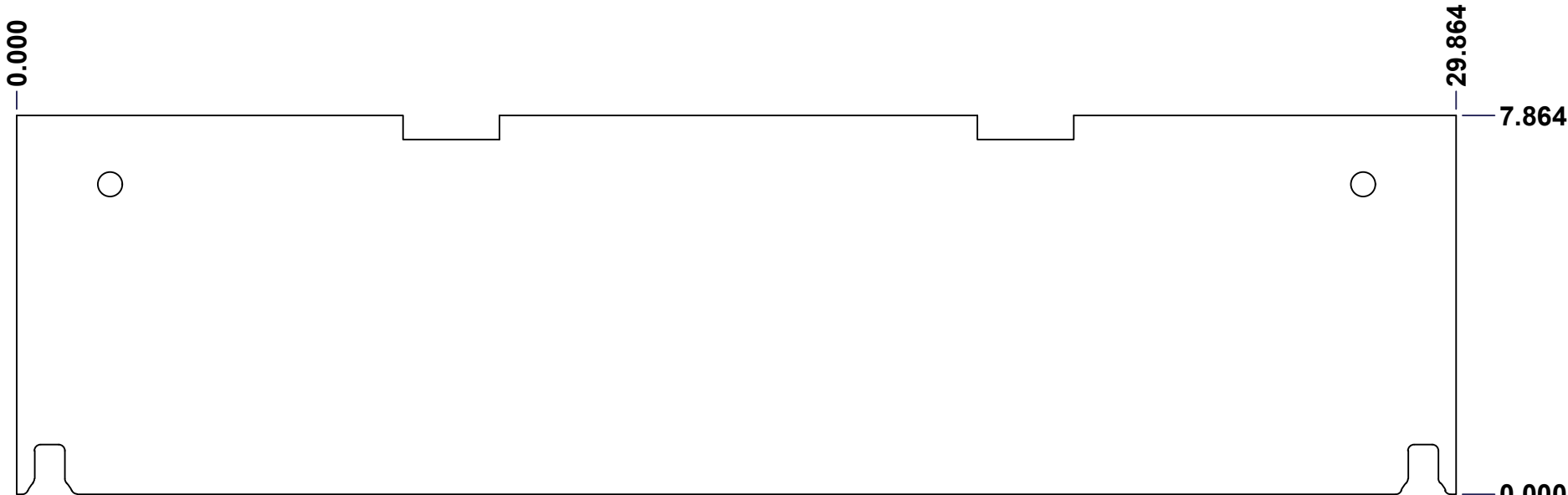

FRONT



RIGHT

No.	Revisions	Date	By/Par

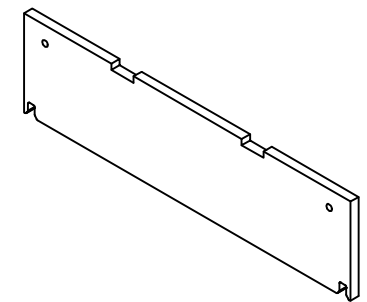

Isometric View



Tél: (450) 979-4373
 Fax: (450) 979-4626
www.exmweb.com

Flatness
Aplatissement
Max 3.0mm
Projection

Customer Client	Date
Drawn By / Dessiné Par: BoxCad: BoxCad	Date: 4/3/2024
Material / Matière: Polyisocyanurate	
Color / Couleur: Aluminum	Finish / Fini: Smooth
Description: 5412ESDG 36" x 30"Bottom Insulation	Detail Rev.
Part Number / Numéro Pièce: 5412ESDG363008THI-BT	Rev. 15
SEE BILL OF MATERIAL ON LAST PAGE	0

SEE BILL OF MATERIAL ON LAST PAGE

5412ESDG363008THI-BT

Rev. 15
0

This drawing is confidential and must not be reproduced or used without the consent of EXM

Ce dessin est confidentiel et ne doit pas être reproduit ou utilisé sans le consentement de EXM

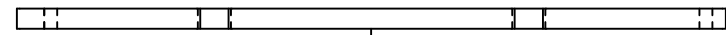

TOP

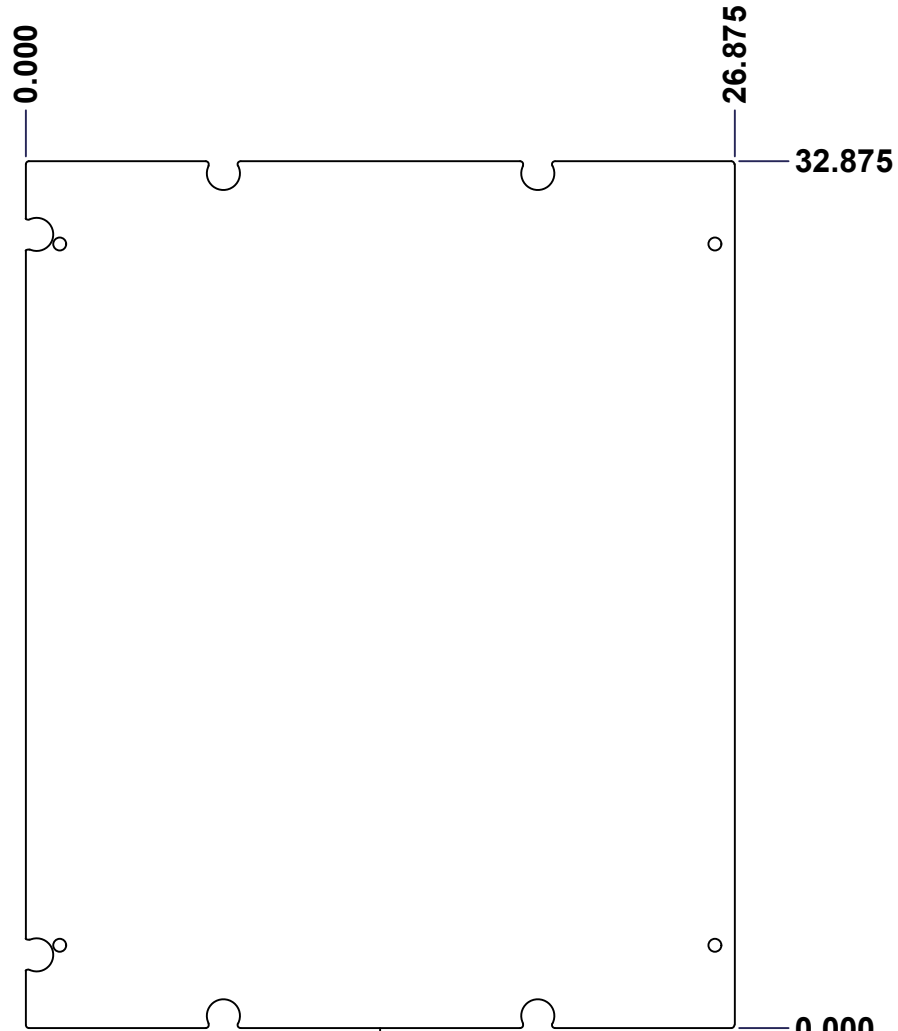

FRONT

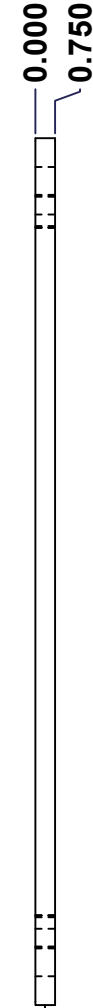

RIGHT

No.	Revisions	Date	By/Par

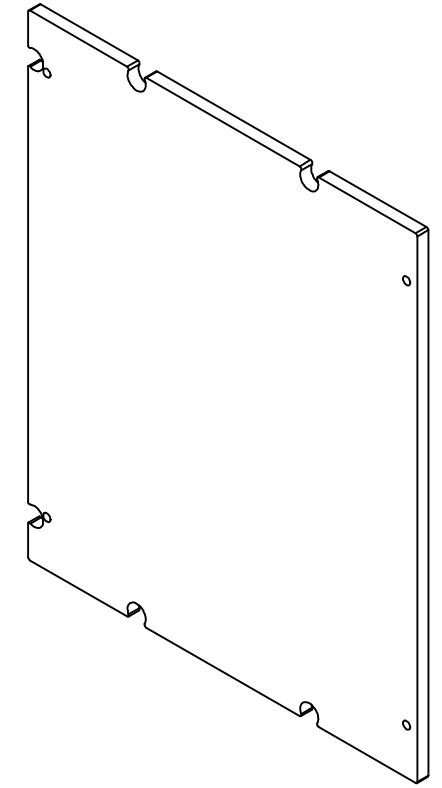

Isometric View



Tél: (450) 979-4373
 Fax: (450) 979-4626
www.exmweb.com

Flatness
Aplatissement

Max 3.0mm

Projection

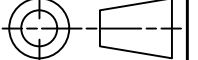

Customer Client	Date
Drawn By Dessiné Par BoxCad: Patrick Deschenes	Date 23-Jan-07
Material Matière Polyisocyanurate	
Color Couleur Aluminum	Finish Fini N/A
Description 5412ESDG 36" x 30" Cover Insulation	Detail Rev.
Part Number Numéro Pièce 5412ESDG363008THI-C	Rev. 16 0

SEE BILL OF MATERIAL ON LAST PAGE

This drawing is confidential and must not be reproduced or used without the consent of EXM

Ce dessin est confidentiel et ne doit pas être reproduit ou utilisé sans le consentement de EXM

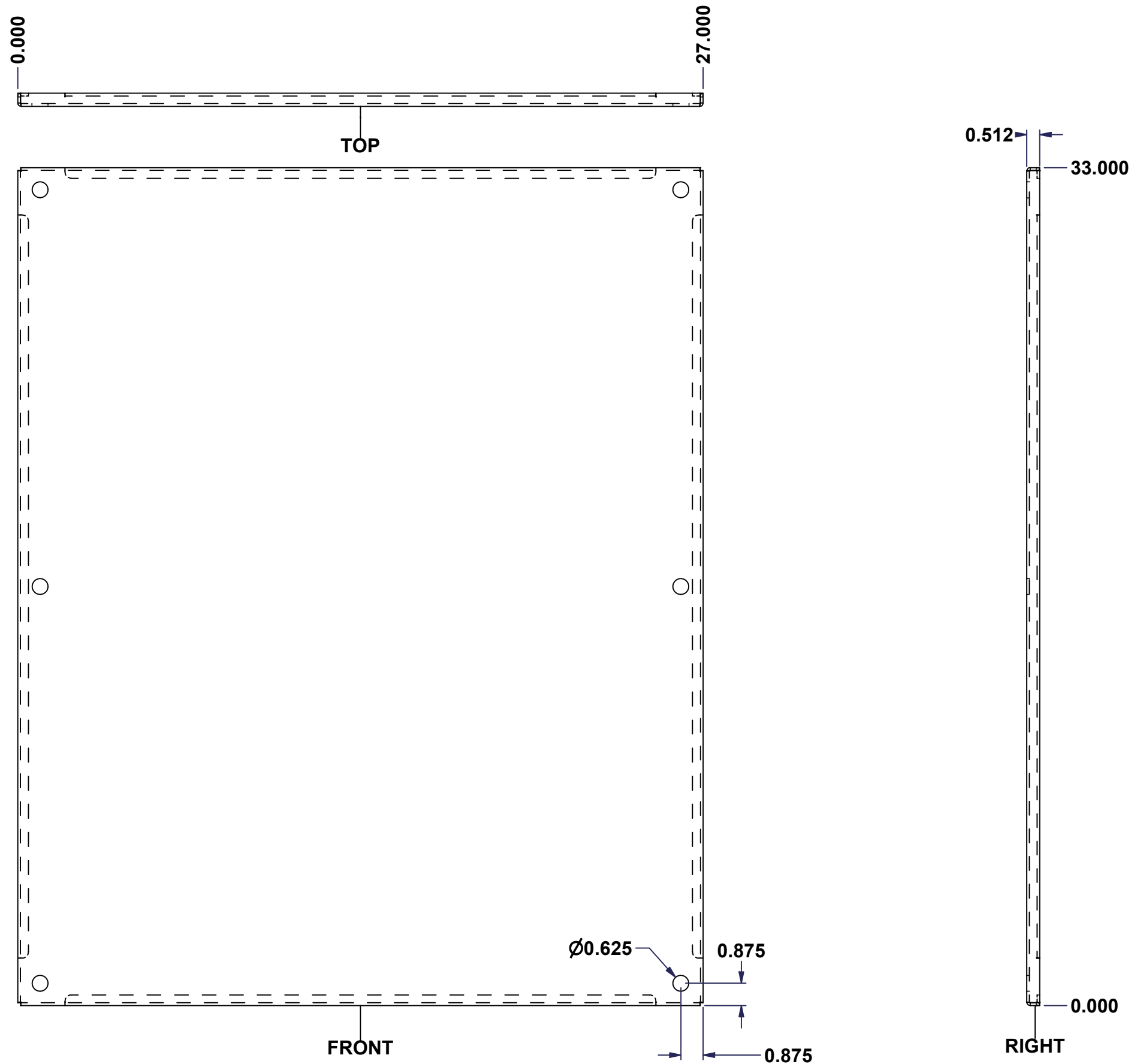

No.	Revisions	Date	By/Par

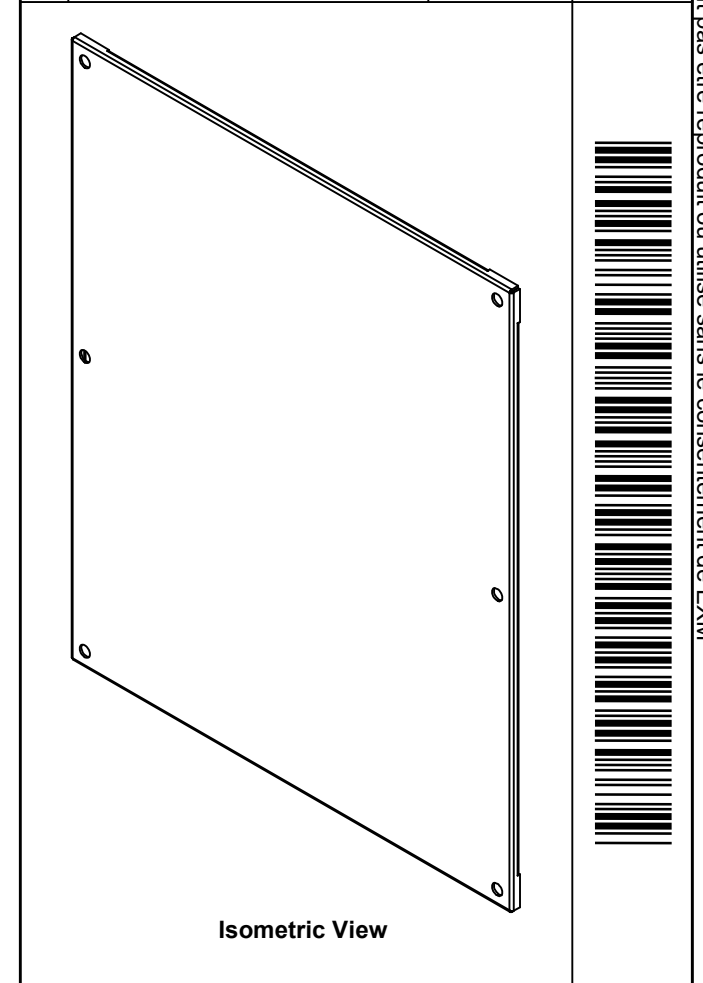

Tél: (450) 979-4373 Fax: (450) 979-4626 www.exmweb.com		Flatness Aplatissement	
		Max 3.0mm	
Customer Client		Date	
Drawn By Dessiné Par: BoxCad: nickz		Date: 01/03/2017	
Material Matière: 12 Ga Galvanized (2.5mm)			
Color Couleur: See Part List		Finish Fini: See Part List	
Description 885SP 36" x 30" Inner Panel Part			Detail Rev.
Part Number Numéro Pièce: 885SP3630G			Rev. 1

Qty	Part Number	Rev	Description	Material	Color	Finish
1	885SP3630G-P	0	885SP 36" x 30" Inner Panel Part	12 Ga Galvanized (2.5mm)	Unpainted	Galvanized

Parts List