

This drawing is confidential and must not be reproduced or used without the consent of EXM

Ce dessin est confidentiel et ne doit pas être reproduit ou utilisé sans le consentement de EXM

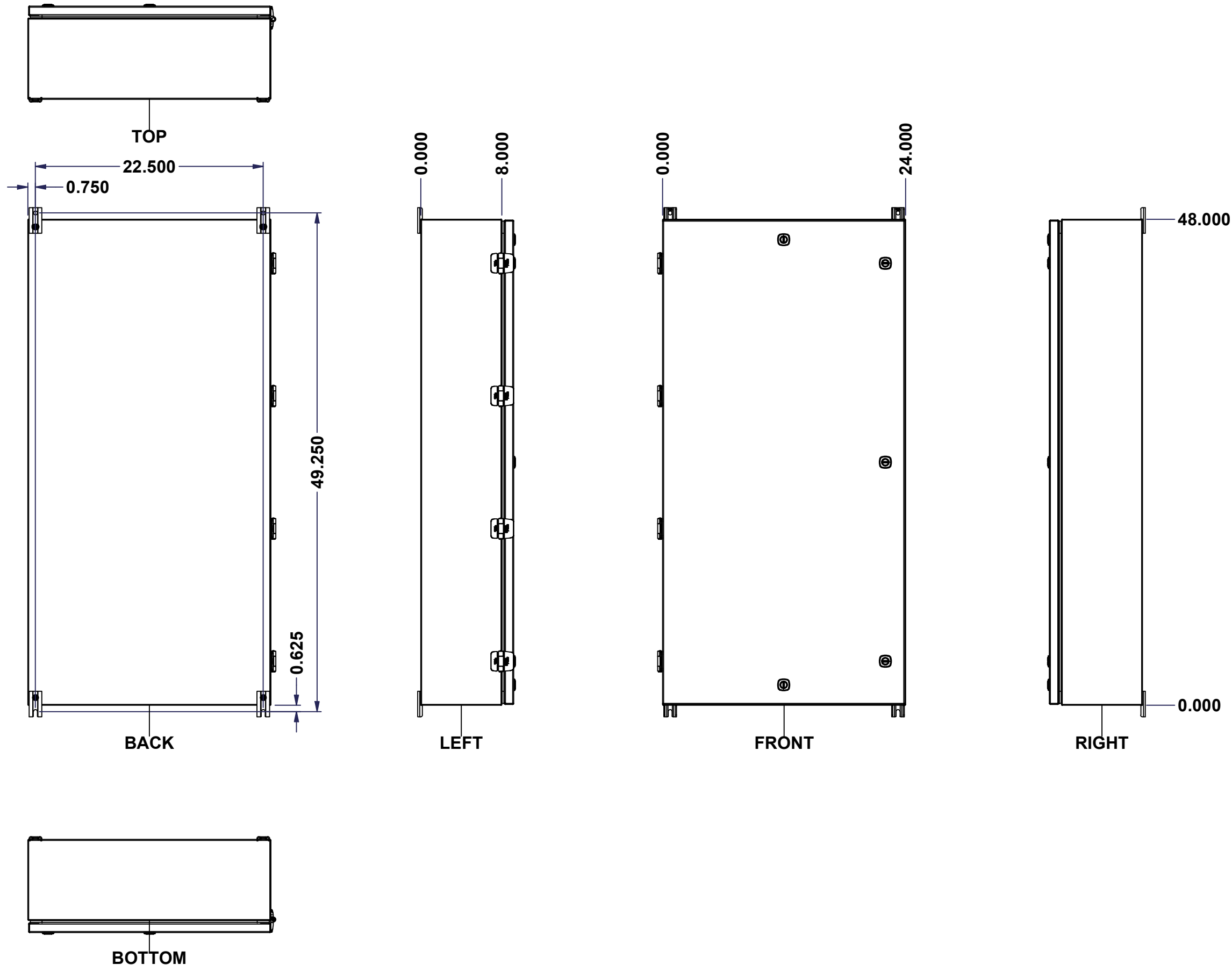

No.	Revisions	Date	By/Par

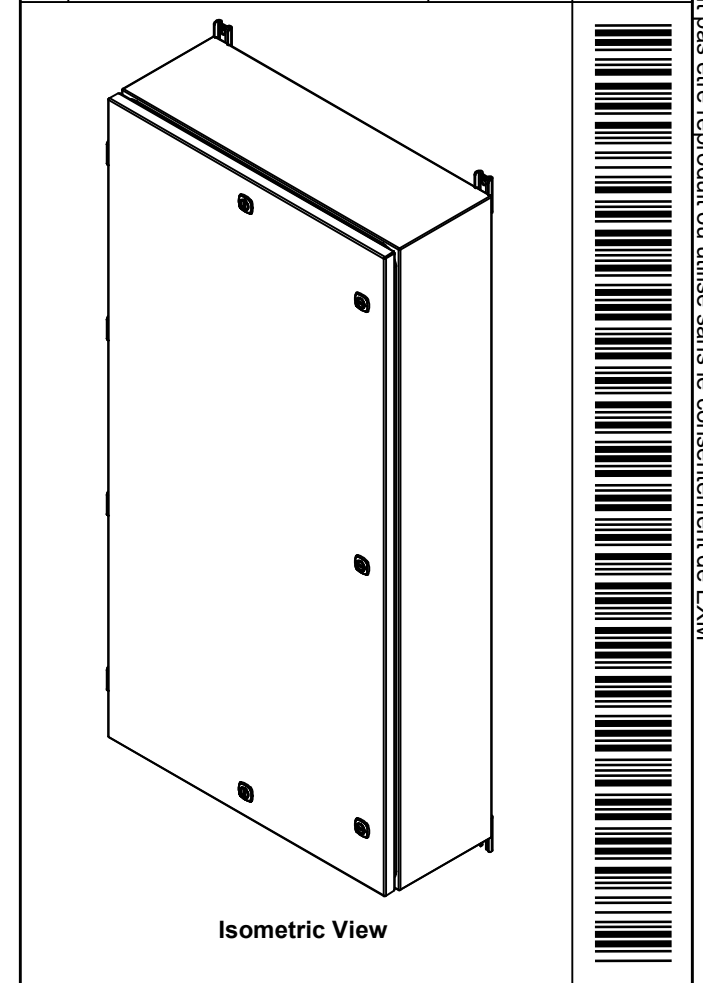

Tél: (450) 979-4373 Fax: (450) 979-4626 www.exmweb.com		Flatness Aplatissement Max 3.0mm Projection
Customer Client	Date	
Drawn By Dessiné Par	BoxCad: BoxCad	Date 02-Jan-25
Material Matière	16 Ga Cold Rolled A1008 CS Type B (1.4mm)	
Color Couleur	Asa-61 Grey	Finish Fini Smooth
Description	Detail Rev.	
5412ESDG 48" x 24" x 8" Assembly		
Part Number Numéro Pièce	Rev. 0	1 / 16
5412ESDG482408TH		

SEE BILL OF MATERIAL ON LAST PAGE

This drawing is confidential and must not be reproduced or used without the consent of EXM

Ce dessin est confidentiel et ne doit pas être reproduit ou utilisé sans le consentement de EXM

NOTE	
ITEM	DESCRIPTION
1	NEMA 4, 12 Enclosure (IP66)
2	C/W Standard ground studs on box and cover
3	C/W Standard door stiffener
4	C/W Standard inner panel (Included)
5	C/W Standard inner panel mounting studs
6	C/W 885 ESMF3_OPEN Sold separately (Installed)
7	C/W 885 ESMF3_CLOSE Sold separately (Installed)
8	C/W R5 Insulation (Installed aluminum visible)

No.	Revisions	Date	By/Par

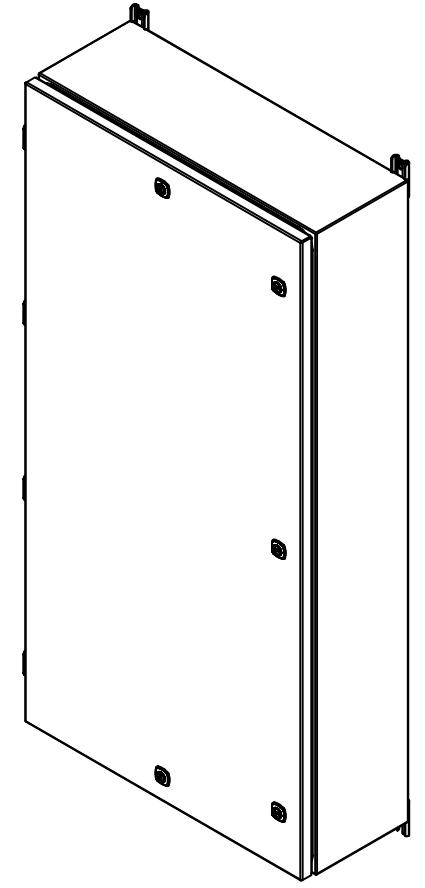

Isometric View



PACKING		
ITEM	QTY	DESCRIPTION
Cardboard sleeve	2	Top and Bottom
Cardboard strip	2	Between back of enclosure and inner panel
Plastic bag	1	To protect cover surface and inside gasket
Cardboard corner	4	To reinforced for the plastic strap tightening
Plastic strap - Black	2	To Squeeze the 2 cardboard sleeve together
Packaging label	3	White label with PN
Plastic strap- Green	2	To secure the enclosure to the wood pallet
Wood Pallet	1	2" deeper and 3" larger than enclosure size

6	STK-Q-00600	2	M12 to M8 Adaptor
1	885SP4824G	0	885SP 48" x 24" Inner Panel Part
1	STK-K-01800	5	5412 ES Accessory Kit
4	STK-Q-10252	0	M6 Stainless Steel Sealing Washer
1	5412ESDG482408THC	0	5412ESDG 48" x 24" Cover
1	5412ESDG482408THB	0	5412ESDG 48" x 24" x 8" Body
4	STK-Q-07220	1	M6 Nylon Insert Lock Nut
Qty	Part Number	Rev	Description
Parts List			

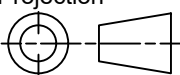
 Tél: (450) 979-4373 Fax: (450) 979-4626 www.exmweb.com	Flatness Aplatissement	Max 3.0mm
	Projection	
Customer Client	Date	
Drawn By Dessiné Par	BoxCad: BoxCad	Date 02-Jan-25
Material Matière	16 Ga Cold Rolled A1008 CS Type B (1.4mm)	
Color Couleur	Asa-61 Grey	Finish Fini Smooth
Description	Detail Rev.	
5412ESDG 48" x 24" x 8" Assembly		
Part Number Numéro Pièce	Rev. 0	2 / 16
5412ESDG482408TH		

This drawing is confidential and must not be reproduced or used without the consent of EXM

Ce dessin est confidentiel et ne doit pas être reproduit ou utilisé sans le consentement de EXM

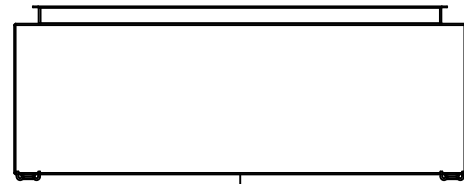

TOP

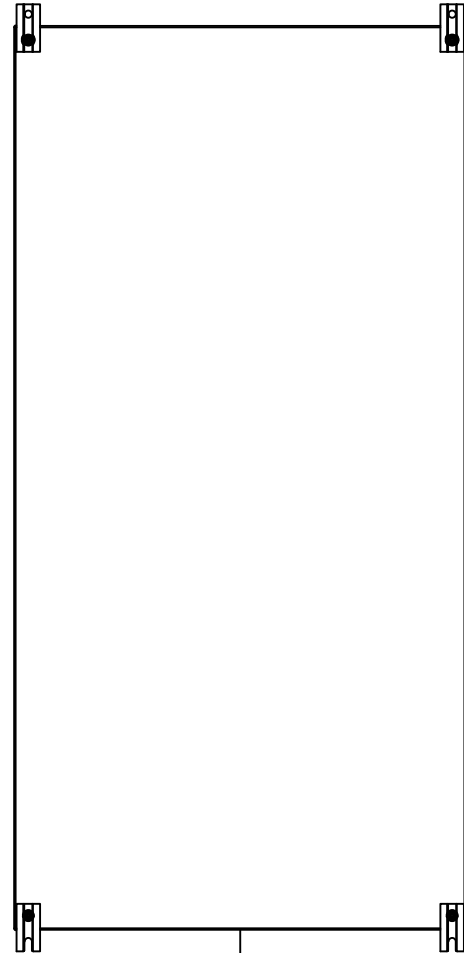

BACK

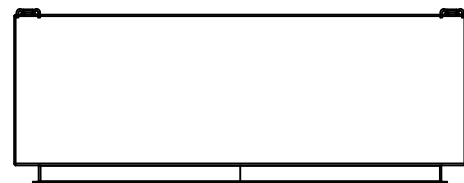

BOTTOM

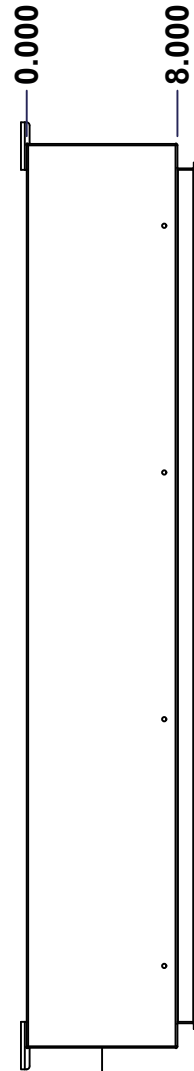

LEFT

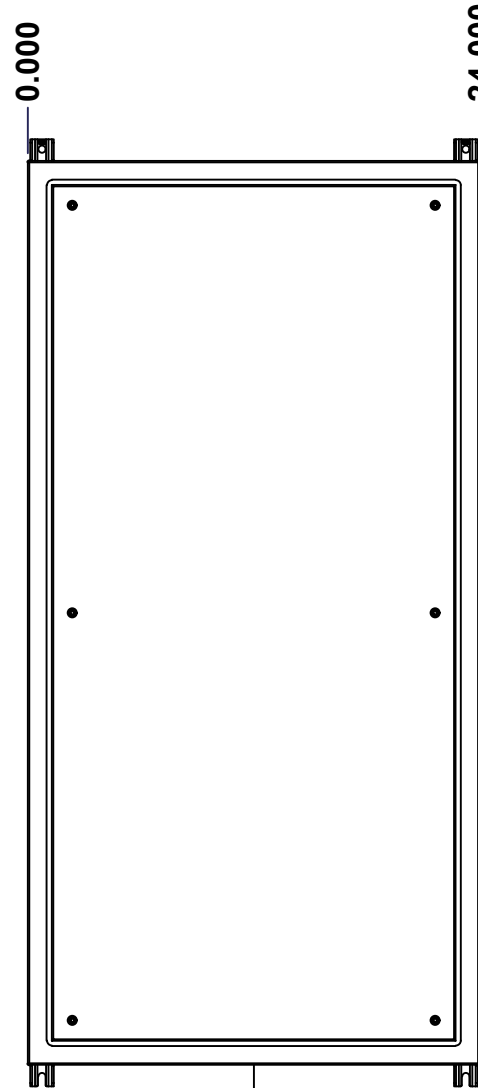

FRONT

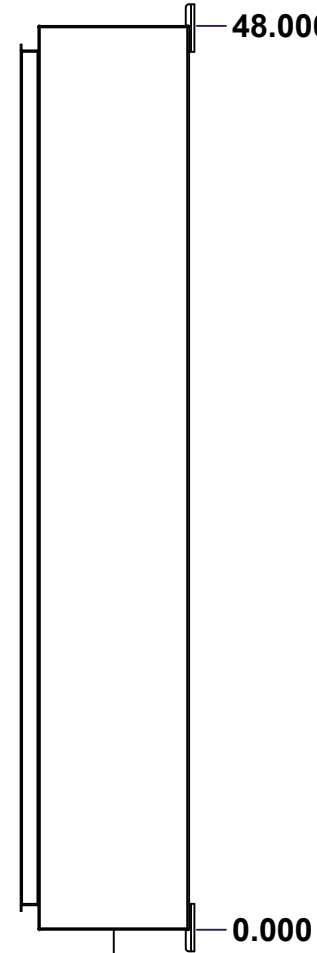

RIGHT

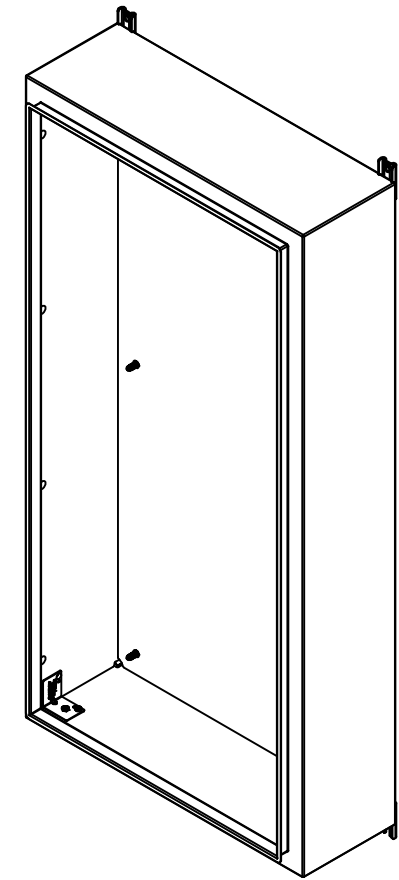

Isometric View

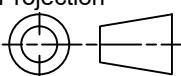

No.	Revisions	Date	By/Par

 Tél: (450) 979-4373 Fax: (450) 979-4626 www.exmweb.com		Flatness Aplatissement Max 3.0mm Projection 
Customer Client	Date	
Drawn By Dessiné Par	BoxCad: BoxCad	Date 02-Jan-25
Material Matière	16 Ga Cold Rolled A1008 CS Type B (1.4mm)	
Color Couleur	Asa-61 Grey	Finish Fini Smooth
Description	Detail Rev.	
5412ESDG 48" x 24" x 8" Body		
Part Number Numéro Pièce	Rev. 0	3 / 16
5412ESDG482408THB		

SEE BILL OF MATERIAL ON LAST PAGE

This drawing is confidential and must not be reproduced or used without the consent of EXM

Ce dessin est confidentiel et ne doit pas être reproduit ou utilisé sans le consentement de EXM

STANDARD FEATURES ARE NOT LISTED IN THIS HOLE TABLE			
HOLE TABLE - TOP VIEW (CUSTOM FEATURE ONLY)			
CUT-OUT	XDIM	YDIM	DESCRIPTION
1	2.000	6.500	INSUL. STUD M6 x 18mm (Inside)
2	22.000	6.500	INSUL. STUD M6 x 18mm (Inside)

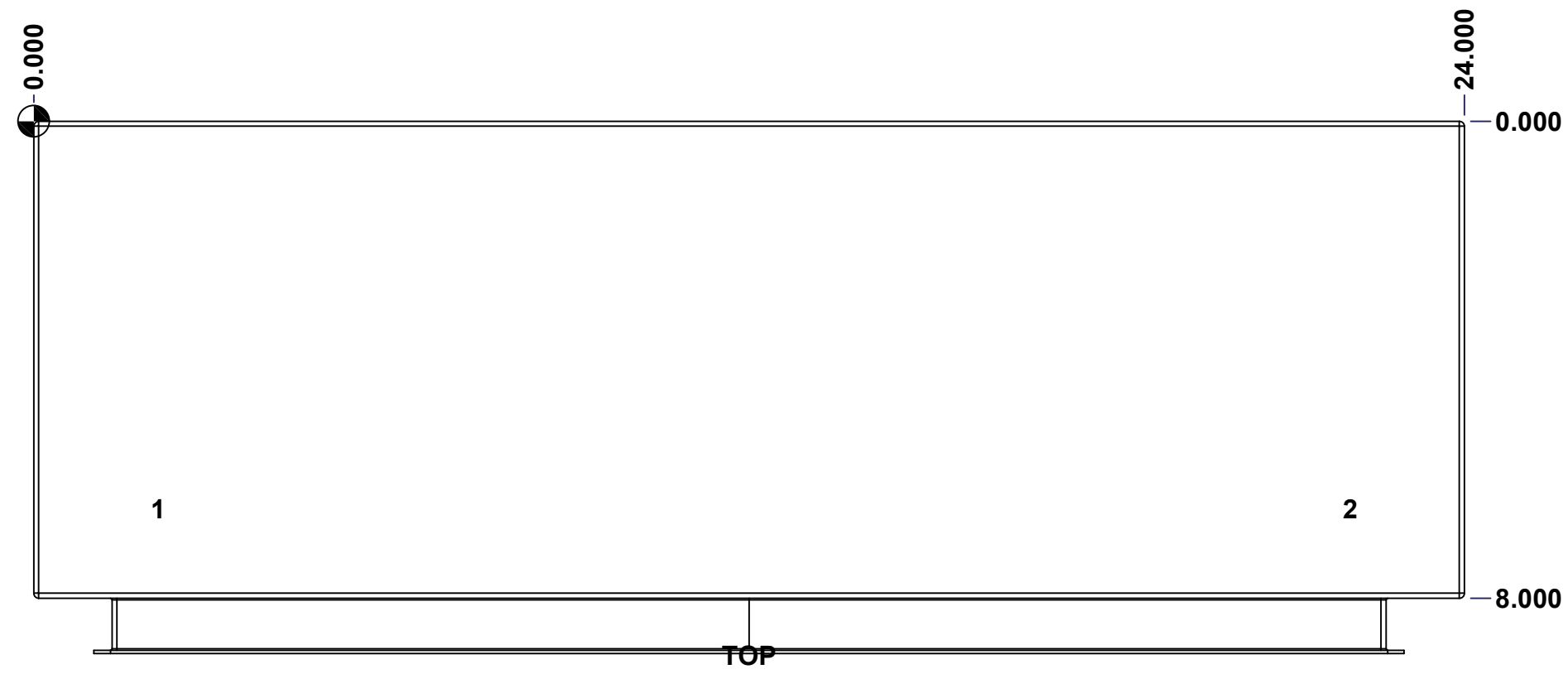

	Description	Status
	5412ESDG 48" x 24" x 8" Body	(NULL)
	Part Number Numéro Pièce	Rev.
	5412ESDG482408THB	0
		4
		16

This drawing is confidential and must not be reproduced or used without the consent of EXM

Ce dessin est confidentiel et ne doit pas être reproduit ou utilisé sans le consentement de EXM

STANDARD FEATURES ARE NOT LISTED IN THIS HOLE TABLE			
HOLE TABLE - BOTTOM VIEW (CUSTOM FEATURE ONLY)			
CUT-OUT	XDIM	YDIM	DESCRIPTION
1	2.000	6.500	INSUL. STUD M6 x 18mm (Inside)
2	22.000	6.500	INSUL. STUD M6 x 18mm (Inside)

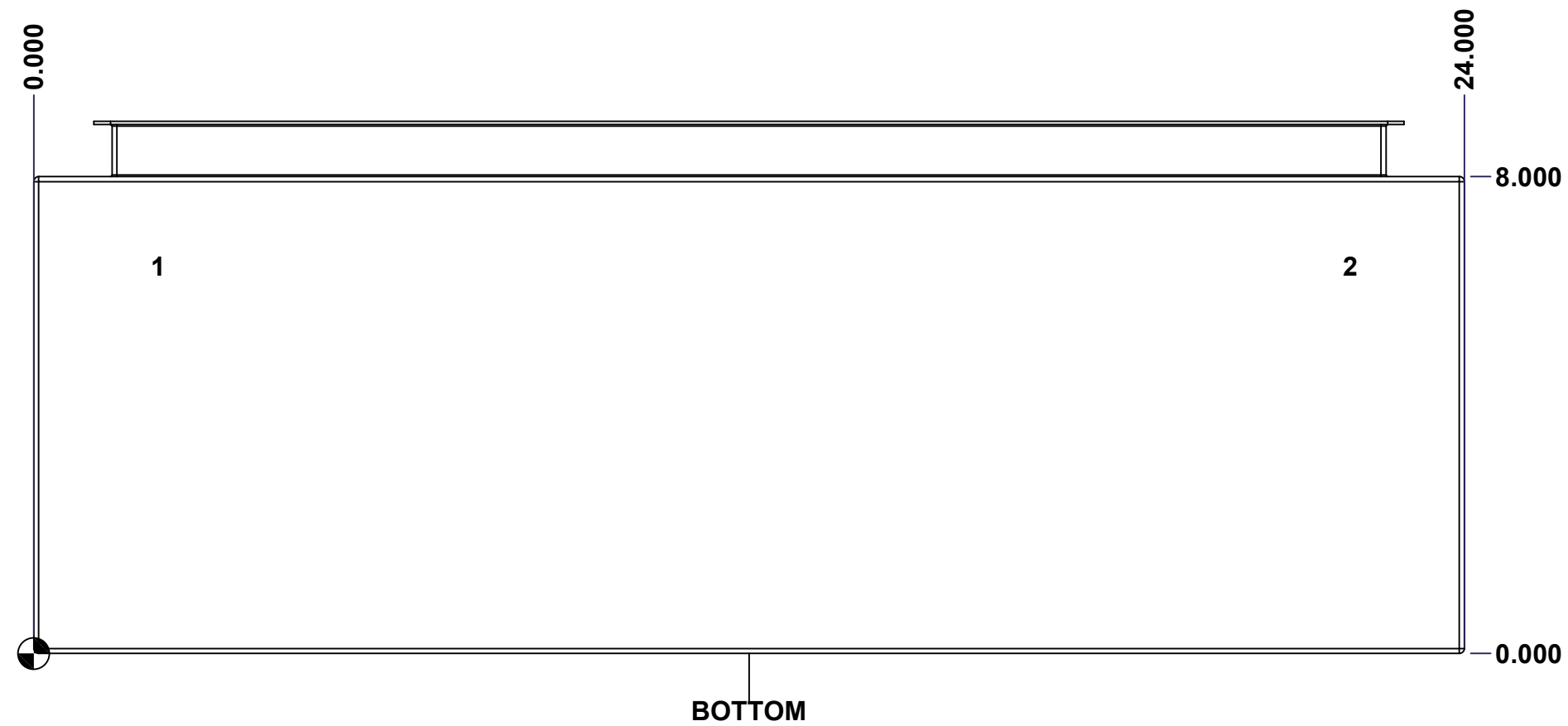

	Description		Status
	5412ESDG 48" x 24" x 8" Body		(NULL)
Part Number Numéro Pièce		Rev.	5
5412ESDG482408THB		0	16

This drawing is confidential and must not be reproduced or used without the consent of EXM

Ce dessin est confidentiel et ne doit pas être reproduit ou utilisé sans le consentement de EXM

STANDARD FEATURES ARE NOT LISTED IN THIS HOLE TABLE

HOLE TABLE - BACK VIEW (CUSTOM FEATURE ONLY)

CUT-OUT	XDIM	YDIM	DESCRIPTION
1	2.375	2.375	IP STUD M8 x 35mm (Inside)
2	2.375	45.625	IP STUD M8 x 35mm (Inside)
3	21.625	45.625	IP STUD M8 x 35mm (Inside)
4	21.625	2.375	IP STUD M8 x 35mm (Inside)
5	2.375	24.000	IP STUD M8 x 35mm (Inside)
6	21.625	24.000	IP STUD M8 x 35mm (Inside)

7	23.250	0.000	FOOT 885 ESMF3_OPEN
8	0.750	0.000	FOOT 885 ESMF3_OPEN
9	23.250	48.000	FOOT 885 ESMF3_CLOSE
10	0.750	48.000	FOOT 885 ESMF3_CLOSE

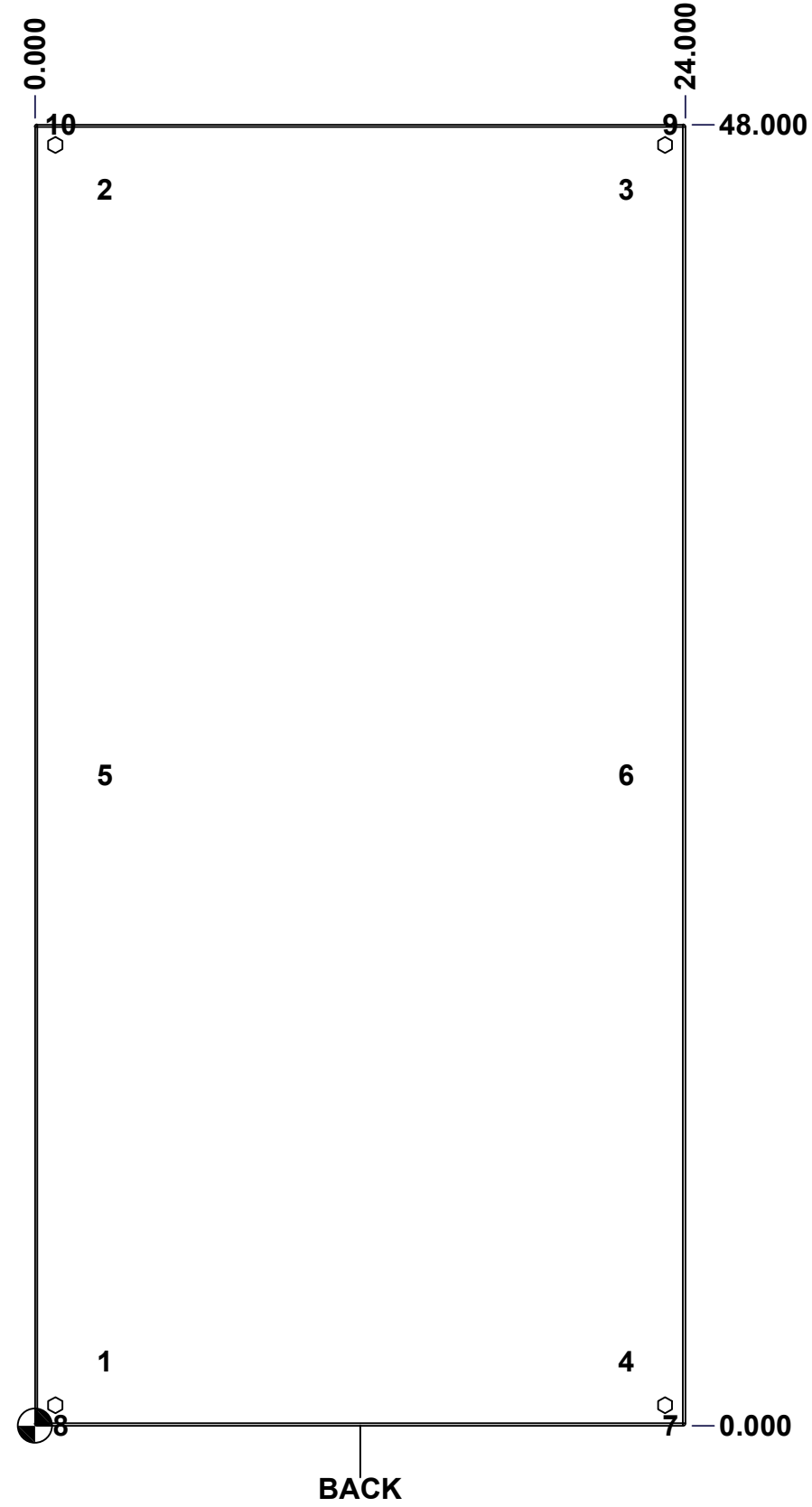

	Description	Status
	5412ESDG 48" x 24" x 8" Body	(NULL)
	Part Number Numéro Pièce	Rev.
	5412ESDG482408THB	0 / 6
		16

This drawing is confidential and must not be reproduced or used without the consent of EXM

Ce dessin est confidentiel et ne doit pas être reproduit ou utilisé sans le consentement de EXM

No.	Revisions	Date	By/Par

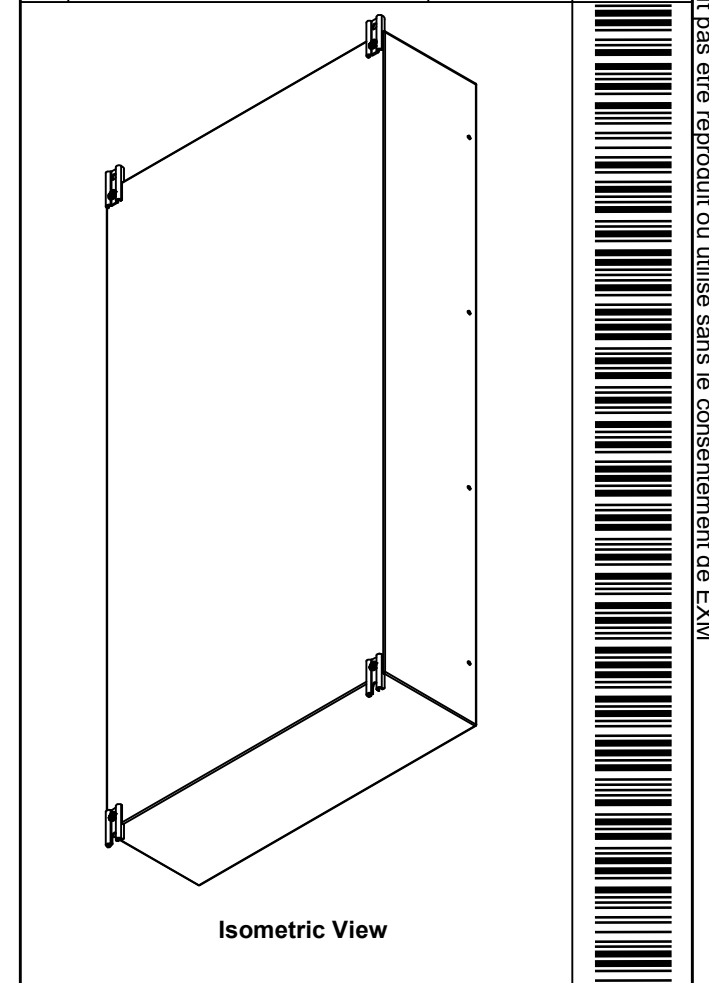

1	885 ESMF3	0	885 ESMF3 Mounting Foot Kit
4	RIVET_NUT_M10_FH_CE	0	Rivet Nut M10 (Low Profile Close End)
1	STK-K-70554	3	5412 ESTH Accessory Kit
1	5412ESDG482408THI-RS	0	5412ESDG 48" x 24" Right Insulation
1	5412ESDG482408THI-LS	0	5412ESDG 48" x 24" Left Insulation
1	5412ESDG482408THI-BT	0	5412ESDG 48" x 24"Bottom Insulation
1	5412ESDG482408THI-TP	0	5412ESDG 48" x 24"Top Insulation
1	5412ESDG482408THI-B	0	5412ESDG 48" x 24" Back Insulation
4	STK-Q-16055	1	M6 x 18mm Stud (No Paint Cap Required)
1	STK-P-02400S	0	Powder Paint (Asa-61 Grey / Smooth)
6	STK-Q-16005	0	Stud M8 x 35mm Steel
1	5412ESDG482408THB-P	0	5412ESDG 48" x 24" x 8" Body Part
Qty	Part Number	Rev	Description
Parts List			

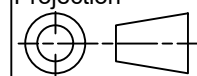
 Tél: (450) 979-4373 Fax: (450) 979-4626 www.exmweb.com		Flatness Aplatissement Max 3.0mm
Projection 		Customer Client
Drawn By Dessiné Par BoxCad: BoxCad		Date 02-Jan-25
Material Matière 16 Ga Cold Rolled A1008 CS Type B (1.4mm)		
Color Couleur Asa-61 Grey	Finish Fini Smooth	
Description 5412ESDG 48" x 24" x 8" Body		Detail Rev.
Part Number Numéro Pièce 5412ESDG482408THB		Rev. 7 0
		16

This drawing is confidential and must not be reproduced or used without the consent of EXM

Ce dessin est confidentiel et ne doit pas être reproduit ou utilisé sans le consentement de EXM

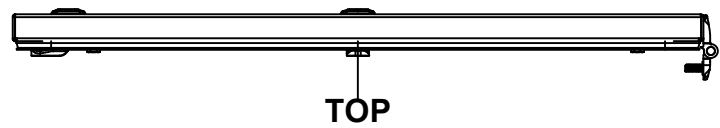

TOP

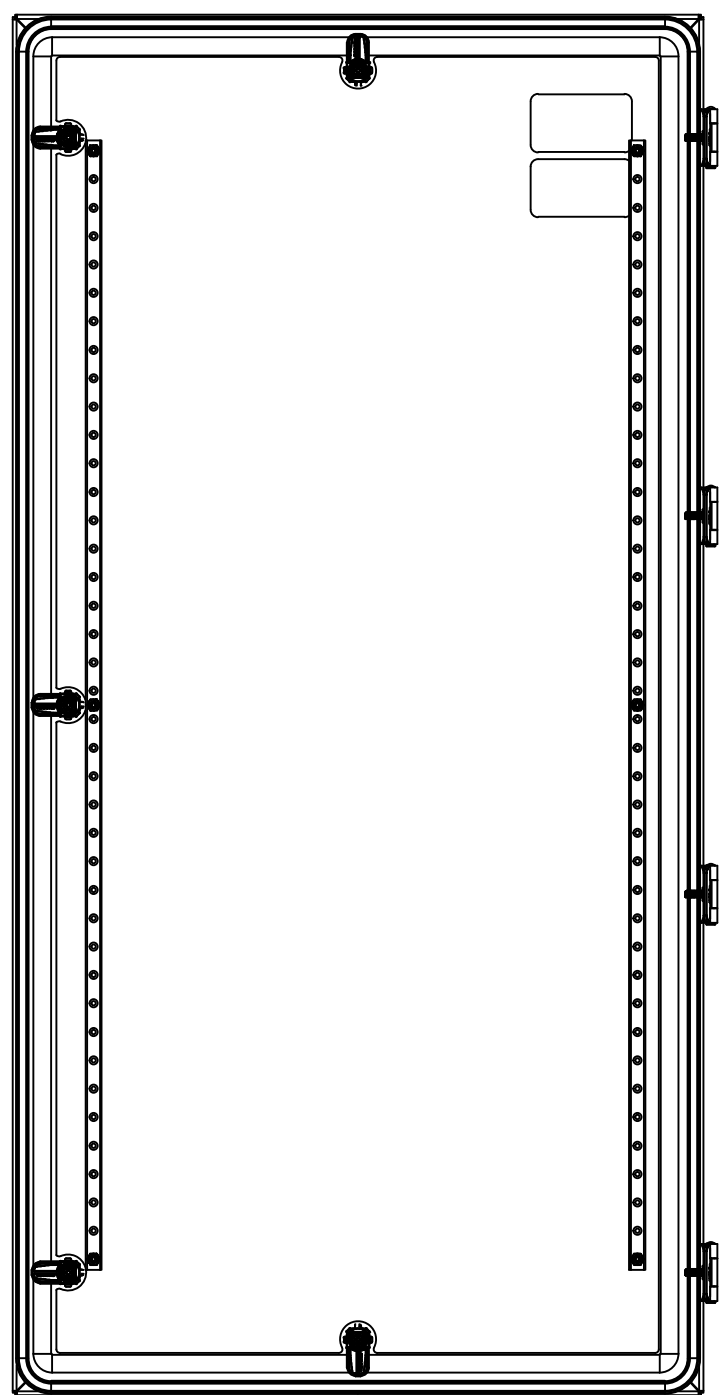

BACK

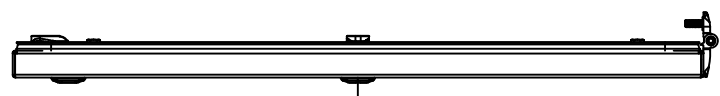

BOTTOM

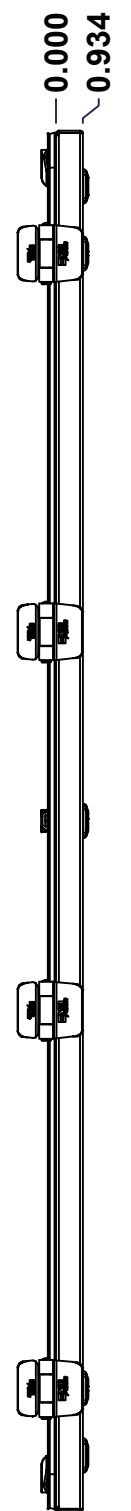

LEFT

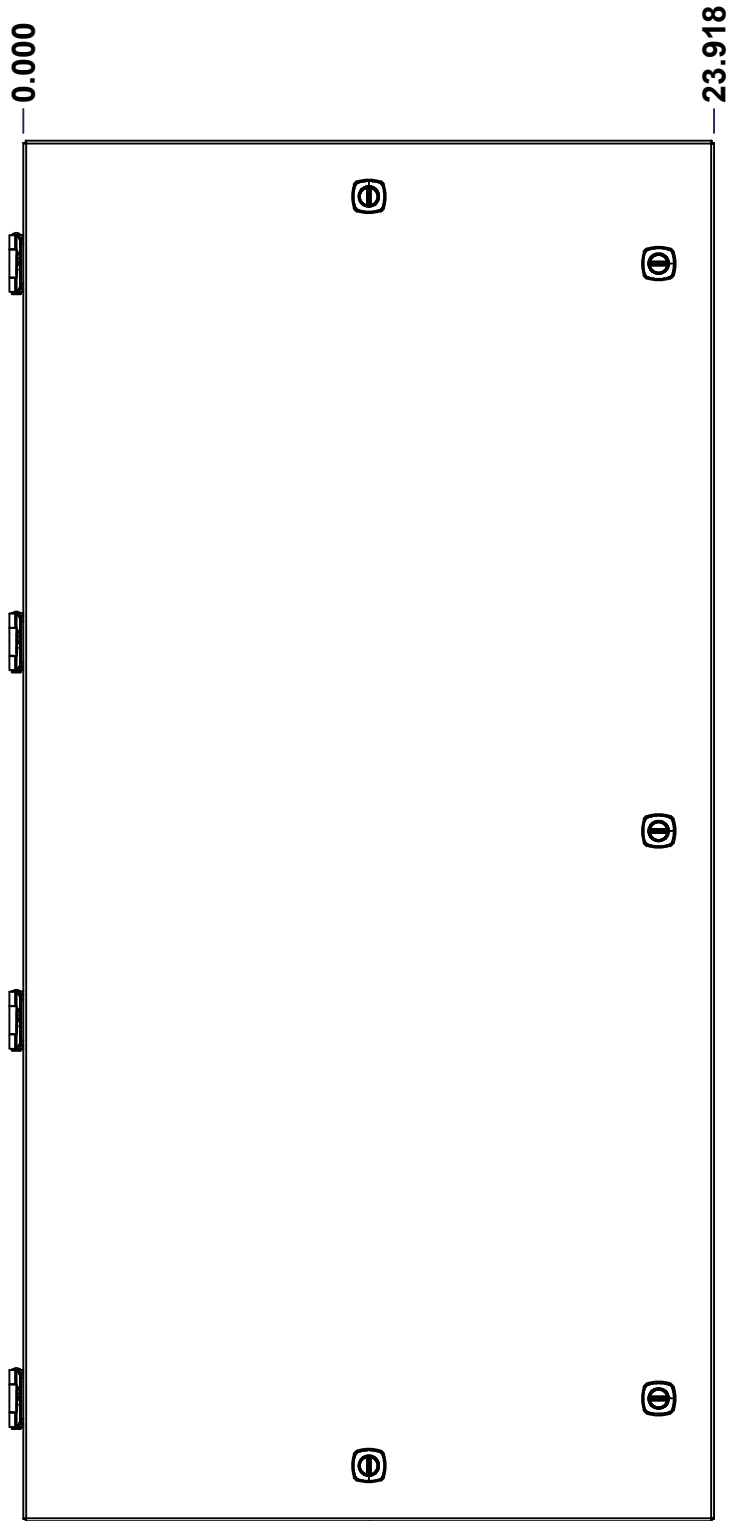

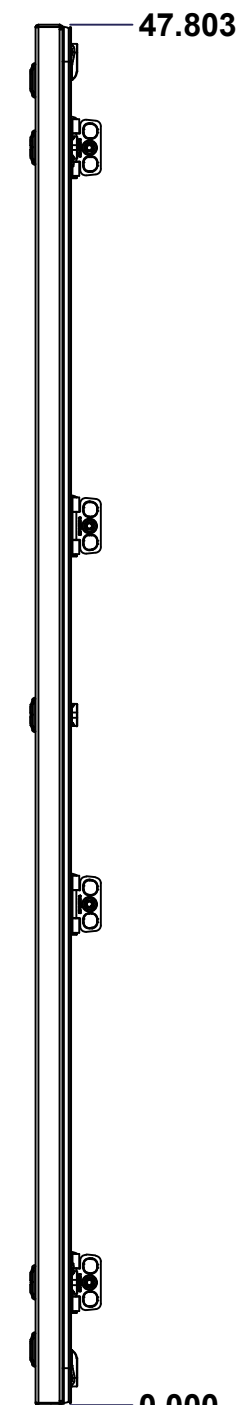

FRONT

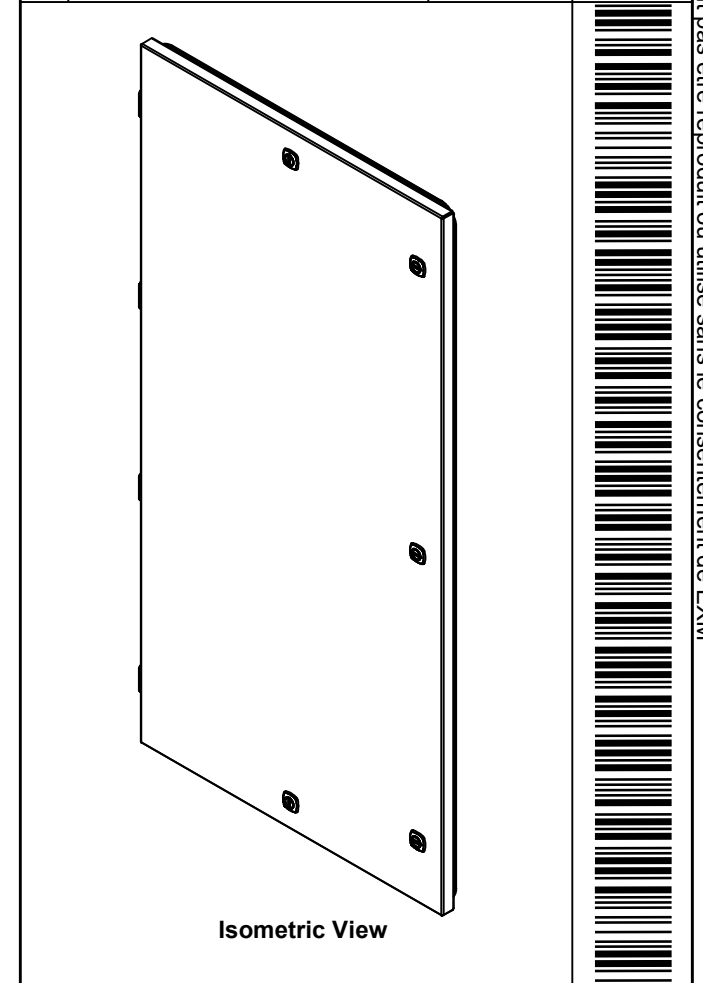

RIGHT

No.	Revisions	Date	By/Par



 Tél: (450) 979-4373 Fax: (450) 979-4626 www.exmweb.com		Flatness Aplatissement
		Max 3.0mm
Customer Client		Date
Drawn By Dessiné Par BoxCad: BoxCad		Date 02-Jan-25
Material Matière 14 Ga Cold Rolled A1008 CS Type B (1.7mm)		
Color Couleur	Asa-61 Grey	Finish Fini Smooth
Description		Detail Rev.
5412ESDG 48" x 24" Cover		
Part Number Numéro Pièce		Rev. 8
5412ESDG482408THC		0

SEE BILL OF MATERIAL ON LAST PAGE

This drawing is confidential and must not be reproduced or used without the consent of EXM

Ce dessin est confidentiel et ne doit pas être reproduit ou utilisé sans le consentement de EXM

STANDARD FEATURES ARE NOT LISTED IN THIS HOLE TABLE

HOLE TABLE - FRONT VIEW (CUSTOM FEATURE ONLY)

CUT-OUT	XDIM	YDIM	DESCRIPTION
1	2.286	4.709	STUD M6 x 18mm (Inside)
2	2.286	43.094	STUD M6 x 18mm (Inside)
3	21.117	43.094	STUD M6 x 18mm (Inside)
4	21.117	4.709	STUD M6 x 18mm (Inside)
5	2.286	23.902	STUD M6 x 18mm (Inside)
6	21.117	23.902	STUD M6 x 18mm (Inside)

7	21.994	43.553	LOCK 880 SCQ4-SL @ 0.0°
8	21.994	23.902	LOCK 880 SCQ4-SL @ 0.0°
9	21.994	4.250	LOCK 880 SCQ4-SL @ 0.0°
10	11.959	45.879	LOCK 880 SCQ4-SL @ 90.0°
11	11.959	1.924	LOCK 880 SCQ4-SL @ 270.0°

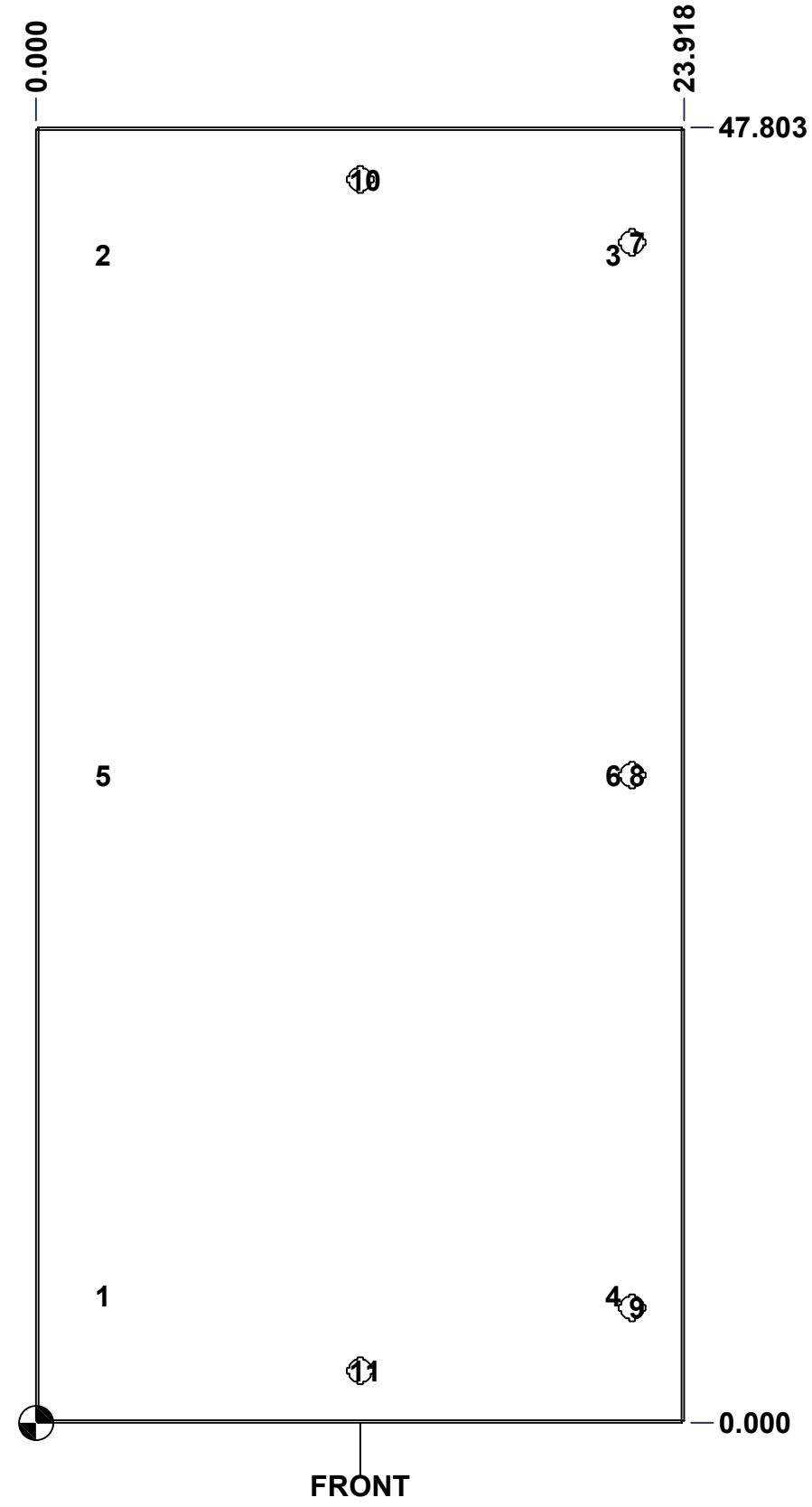

	Description	Status
	5412ESDG 48" x 24" Cover	(NULL)
Part Number Numéro Pièce 5412ESDG482408THC	Rev.	9
	0	16

This drawing is confidential and must not be reproduced or used without the consent of EXM

Ce dessin est confidentiel et ne doit pas être reproduit ou utilisé sans le consentement de EXM

No.	Revisions	Date	By/Par

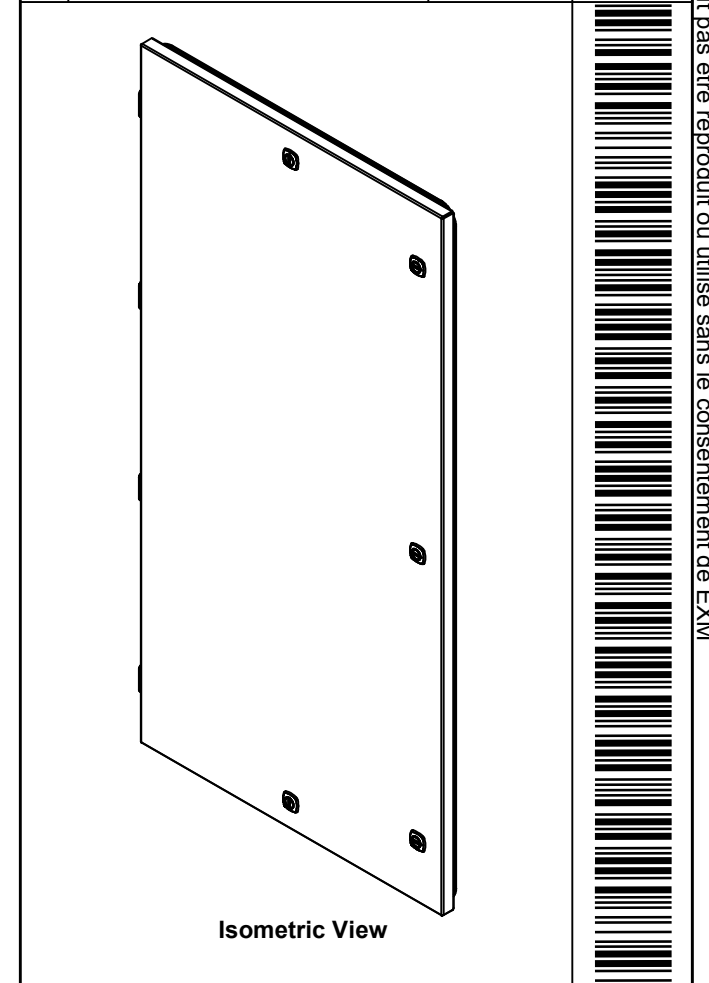

5	STK-K-12500	19	5412 ES 1/4 Turn Lock
2	STK-S-00100	0	3.5" x 2" Silver Milar Flexcon Sticker
6	STK-Q-07250	2	M6 x 16mm Collar Nut
2	STK-Q-46020-42	6	5412 ES Vertical Door Stiffener 42"
1	5412ESDG482408THI-C	0	5412ESDG 48" x 24" Cover Insulation
1	STK-P-02400S	0	Powder Paint (Asa-61 Grey / Smooth)
6	STK-Q-16055	1	M6 x 18mm Stud (No Paint Cap Required)
1	5412ESDG482408THG2	0	5412ESDG 48" x 24" Cover Gasket
1	5412ESDG482408THG	0	5412ESDG 48" x 24" Cover Gasket
1	5412ESDG482408THC-P	0	5412ESDG 48" x 24" Cover Part
4	STK-A-02360	0	External Hinge for Double Gasket
4	STK-Q-07220	1	M6 Nylon Insert Lock Nut
4	STK-Q-10252	0	M6 Stainless Steel Sealing Washer
QTY	Part Number	Rev	Description
Parts List			

 Tél: (450) 979-4373 Fax: (450) 979-4626 www.exmweb.com		Flatness Aplatissement	
		Max 3.0mm	
Customer Client		Date	
Drawn By Dessiné Par		Date 02-Jan-25	
Material Matière		14 Ga Cold Rolled A1008 CS Type B (1.7mm)	
Color Couleur	Asa-61 Grey	Finish Fini	Smooth
Description			Detail Rev.
5412ESDG 48" x 24" Cover			
Part Number Numéro Pièce		Rev.	10
5412ESDG482408THC		0	16

This drawing is confidential and must not be reproduced or used without the consent of EXM

Ce dessin est confidentiel et ne doit pas être reproduit ou utilisé sans le consentement de EXM

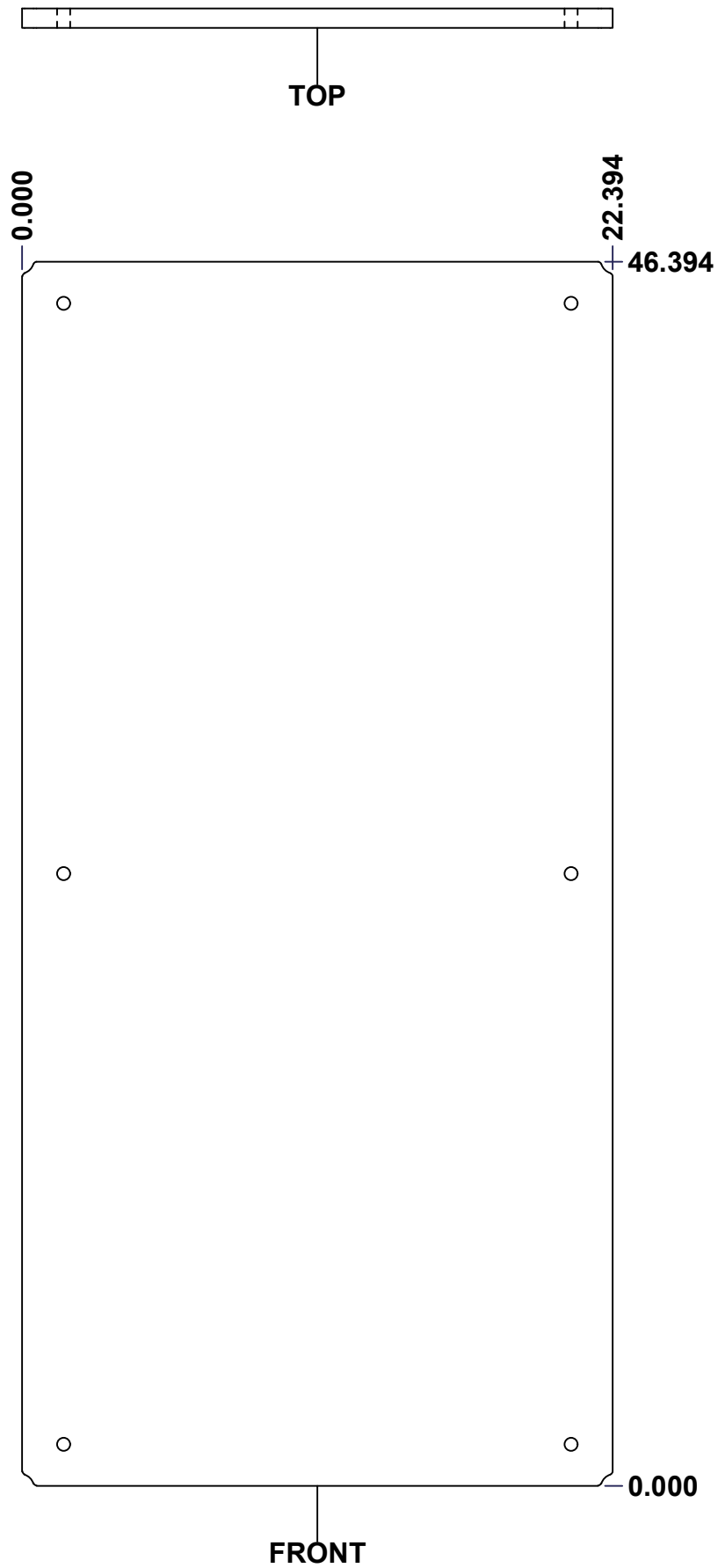

0.000
0.750

No.	Revisions	Date	By/Par

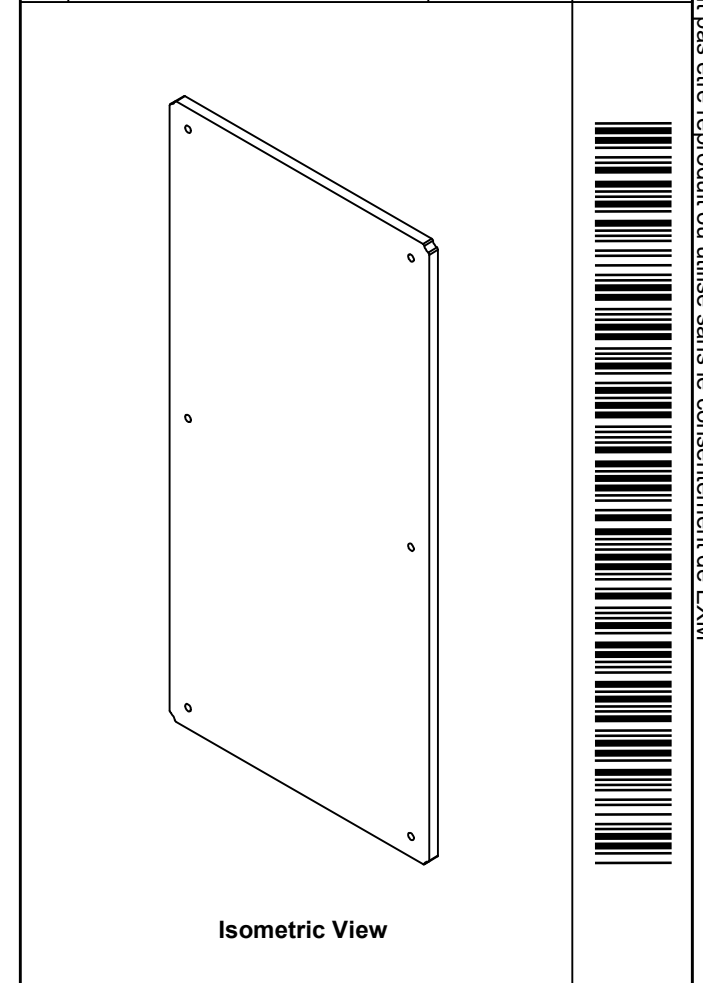

Isometric View



Tél: (450) 979-4373
Fax: (450) 979-4626
www.exmweb.com

Flatness
Aplatissement
Max 3.0mm
Projection

Customer Client	Date
Drawn By / Dessiné Par: BoxCad: Patrick Deschenes	Date: 23-Jan-07
Material / Matière: Polyisocyanurate	
Color / Couleur: Aluminum	Finish / Fini: N/A

Description: 5412ESDG 48" x 24" Back Insulation	Detail Rev.
---	-------------

Part Number / Numéro Pièce: 5412ESDG482408TH-B	Rev. 0	11 / 16
--	--------	---------

SEE BILL OF MATERIAL ON LAST PAGE

This drawing is confidential and must not be reproduced or used without the consent of EXM

Ce dessin est confidentiel et ne doit pas être reproduit ou utilisé sans le consentement de EXM

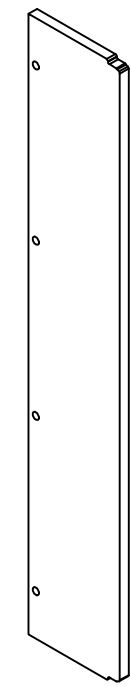
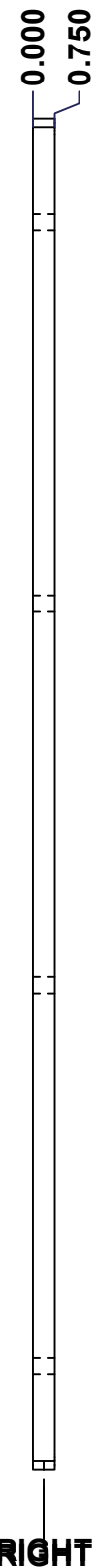
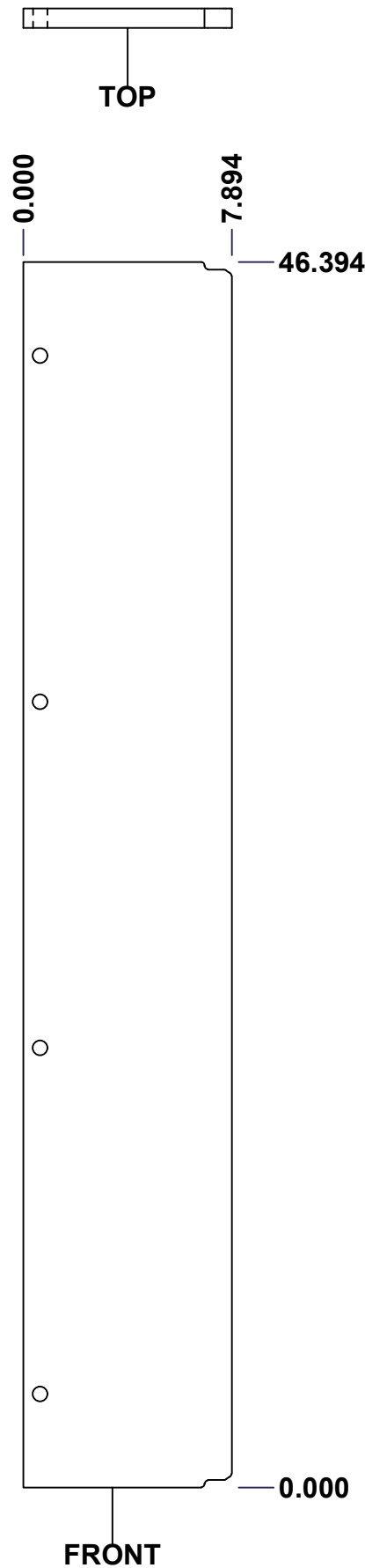

Isometric View

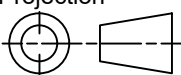

No.	Revisions	Date	By/Par

 Tél: (450) 979-4373 Fax: (450) 979-4626 www.exmweb.com		Flatness Aplatissement Max 3.0mm Projection 
Customer Client	Date	
Drawn By Dessiné Par	BoxCad: Patrick Deschenes	Date 23-Jan-07
Material Matière	Polyisocyanurate	
Color Couleur	Aluminum	Finish Fini N/A
Description 5412ESDG 48" x 24" Left Insulation		Detail Rev.
Part Number Numéro Pièce	Rev. 0	12 / 16

SEE BILL OF MATERIAL ON LAST PAGE

5412ESDG482408THI-LS

This drawing is confidential and must not be reproduced or used without the consent of EXM

Ce dessin est confidentiel et ne doit pas être reproduit ou utilisé sans le consentement de EXM

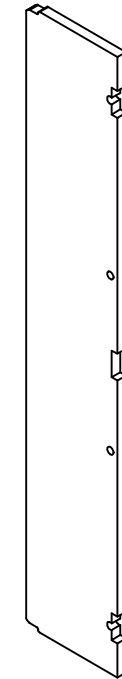
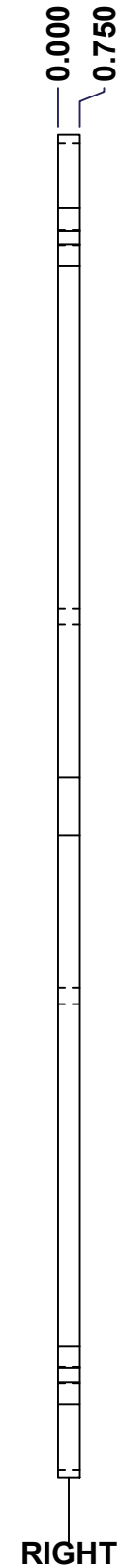
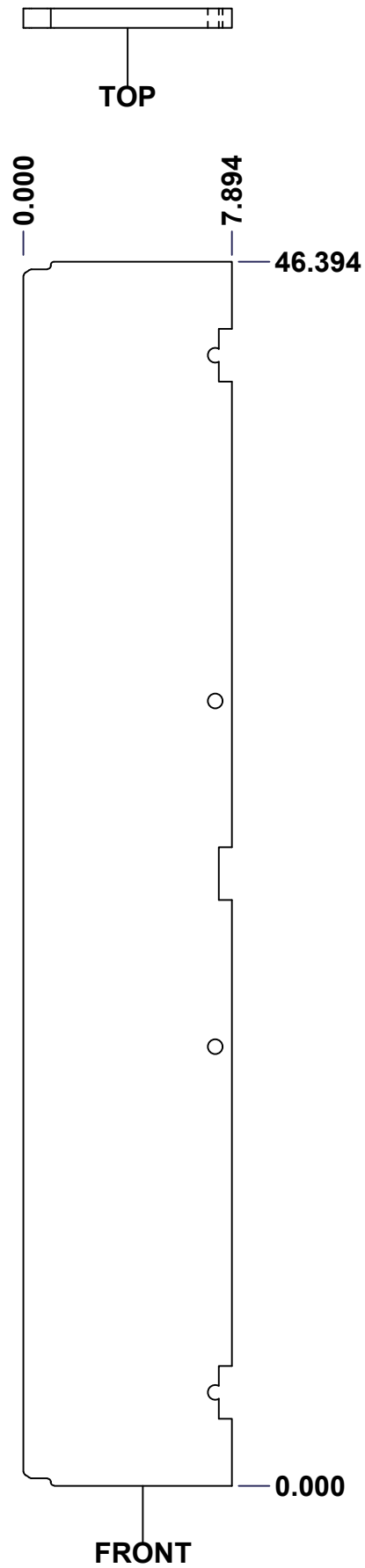

Isometric View

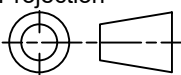

No.	Revisions	Date	By/Par

 Tél: (450) 979-4373 Fax: (450) 979-4626 www.exmweb.com		Flatness Aplatissement Max 3.0mm Projection 
Customer Client	Date	
Drawn By Dessiné Par	BoxCad: Patrick Deschenes	Date 23-Jan-07
Material Matière	Polyisocyanurate	
Color Couleur	Aluminum	Finish Fini N/A
Description	Detail Rev.	
5412ESDG 48" x 24" Right Insulation		
Part Number Numéro Pièce	Rev.	13
5412ESDG482408TH-RS	0	16

SEE BILL OF MATERIAL ON LAST PAGE

This drawing is confidential and must not be reproduced or used without the consent of EXM

Ce dessin est confidentiel et ne doit pas être reproduit ou utilisé sans le consentement de EXM

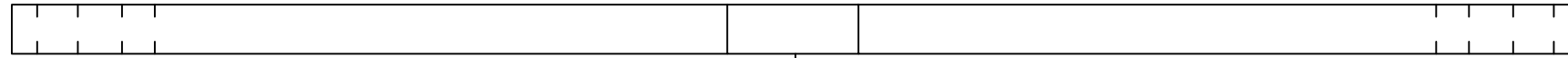

TOP

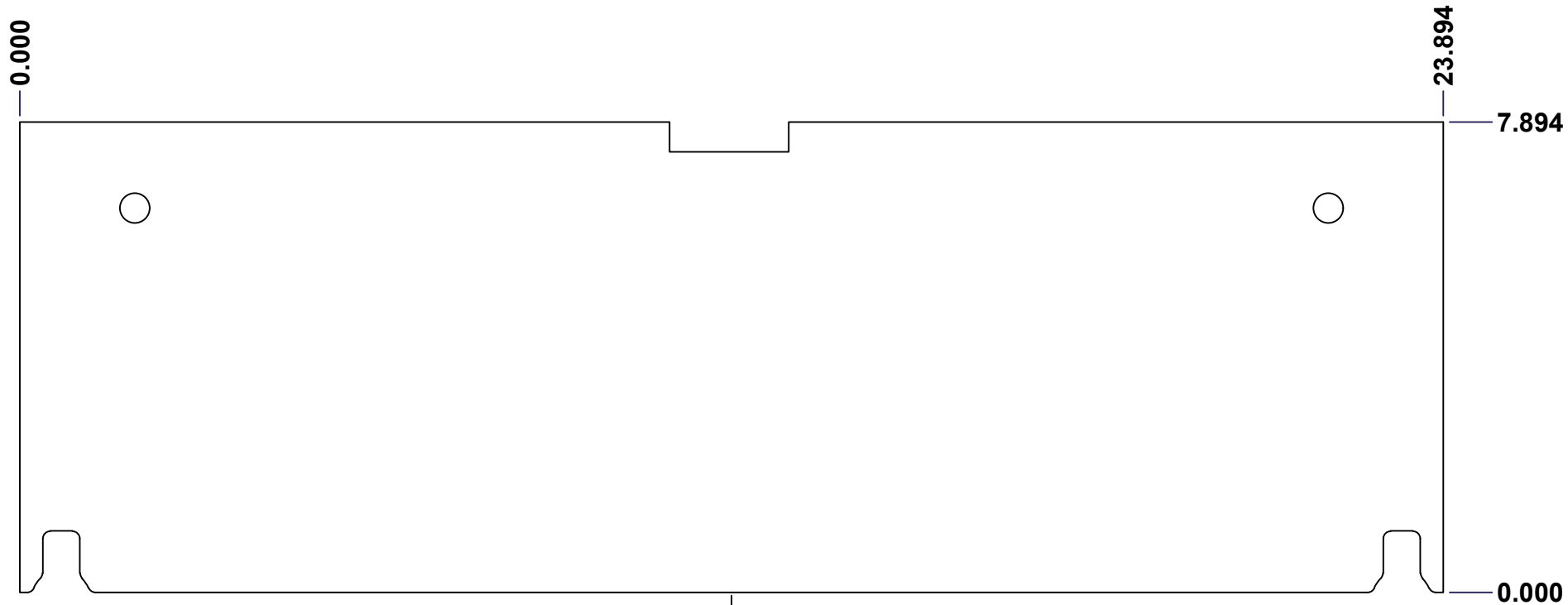

FRONT

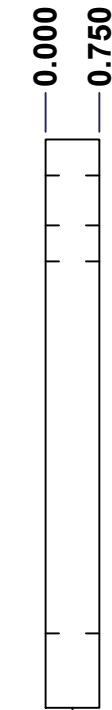

RIGHT

No.	Revisions	Date	By/Par

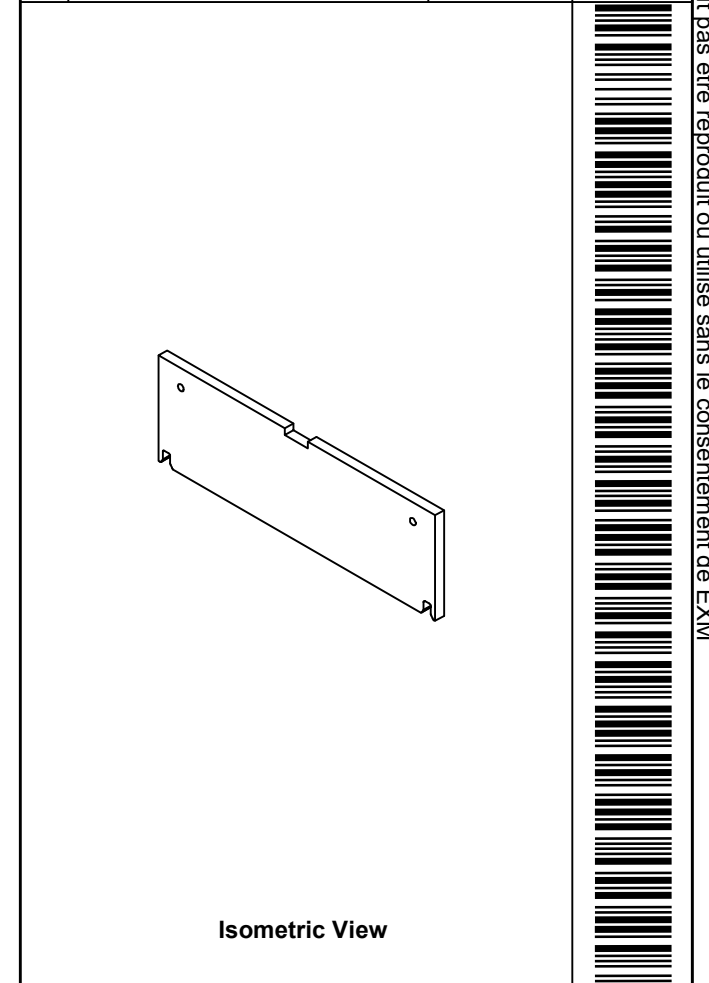

Isometric View

Tél: (450) 979-4373 Fax: (450) 979-4626 www.exmweb.com		Flatness Aplatissement Max 3.0mm Projection
Customer Client	Date	
Drawn By Dessiné Par	BoxCad: BoxCad	Date 4/3/2024
Material Matière	Polyisocyanurate	
Color Couleur	Aluminum	Finish Fini Smooth
Description	Detail Rev.	
5412ESDG 48" x 24"Top Insulation		
Part Number Numéro Pièce	Rev. 0	14 / 16

SEE BILL OF MATERIAL ON LAST PAGE

5412ESDG482408THI-TP

This drawing is confidential and must not be reproduced or used without the consent of EXM

Ce dessin est confidentiel et ne doit pas être reproduit ou utilisé sans le consentement de EXM



TOP

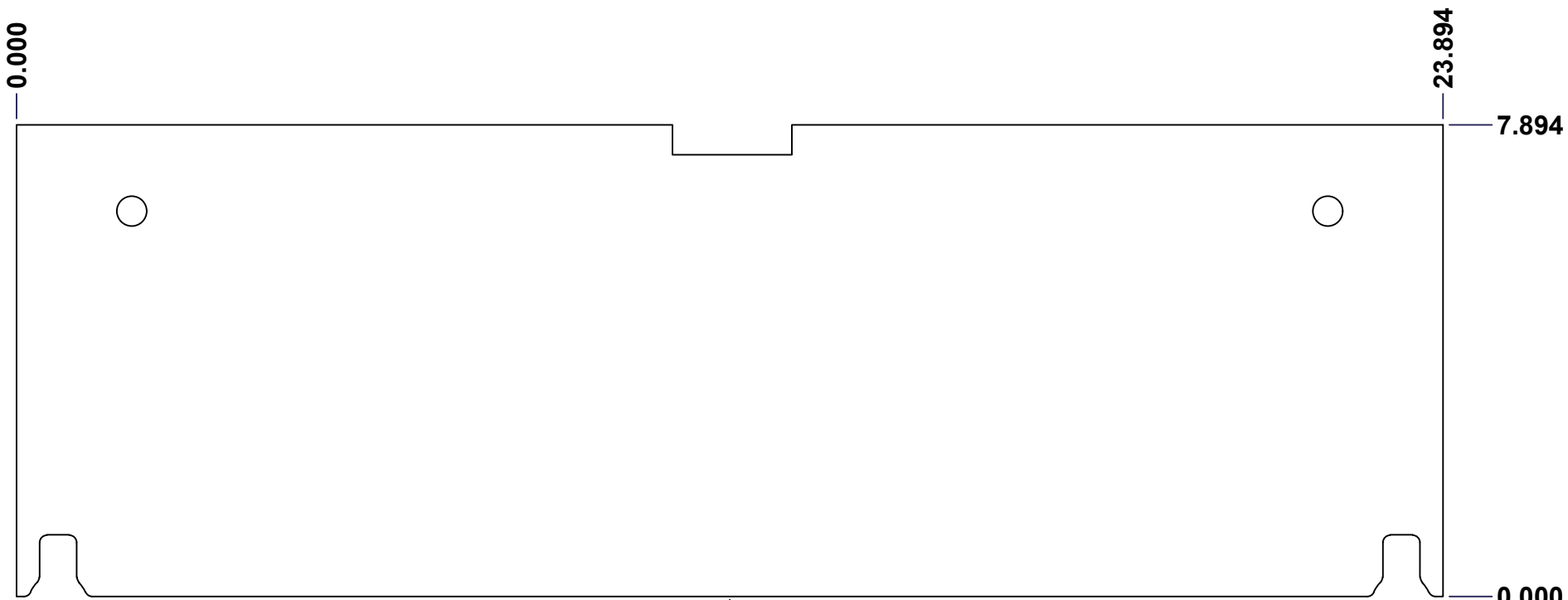

FRONT



RIGHT

No.	Revisions	Date	By/Par

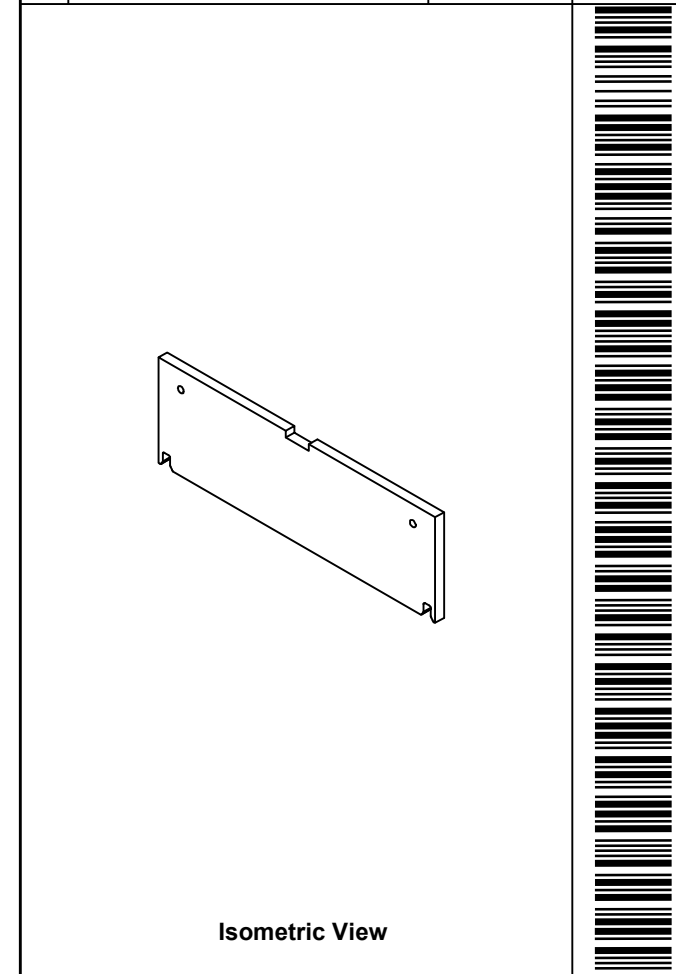

 Tél: (450) 979-4373
 Fax: (450) 979-4626
www.exmweb.com

Flatness / Aplatissement: Max 3.0mm
 Projection: 

Customer Client	Date
Drawn By / Dessiné Par: BoxCad: BoxCad	Date: 4/3/2024

Material / Matière: Polyisocyanurate

Color / Couleur: Aluminum	Finish / Fini: Smooth
---------------------------	-----------------------

Description: 5412ESDG 48" x 24"Bottom Insulation	Detail Rev.
--	-------------

Part Number / Numéro Pièce: 5412ESDG482408THI-BT	Rev. 0	15 / 16
--	--------	---------

SEE BILL OF MATERIAL ON LAST PAGE

This drawing is confidential and must not be reproduced or used without the consent of EXM

Ce dessin est confidentiel et ne doit pas être reproduit ou utilisé sans le consentement de EXM

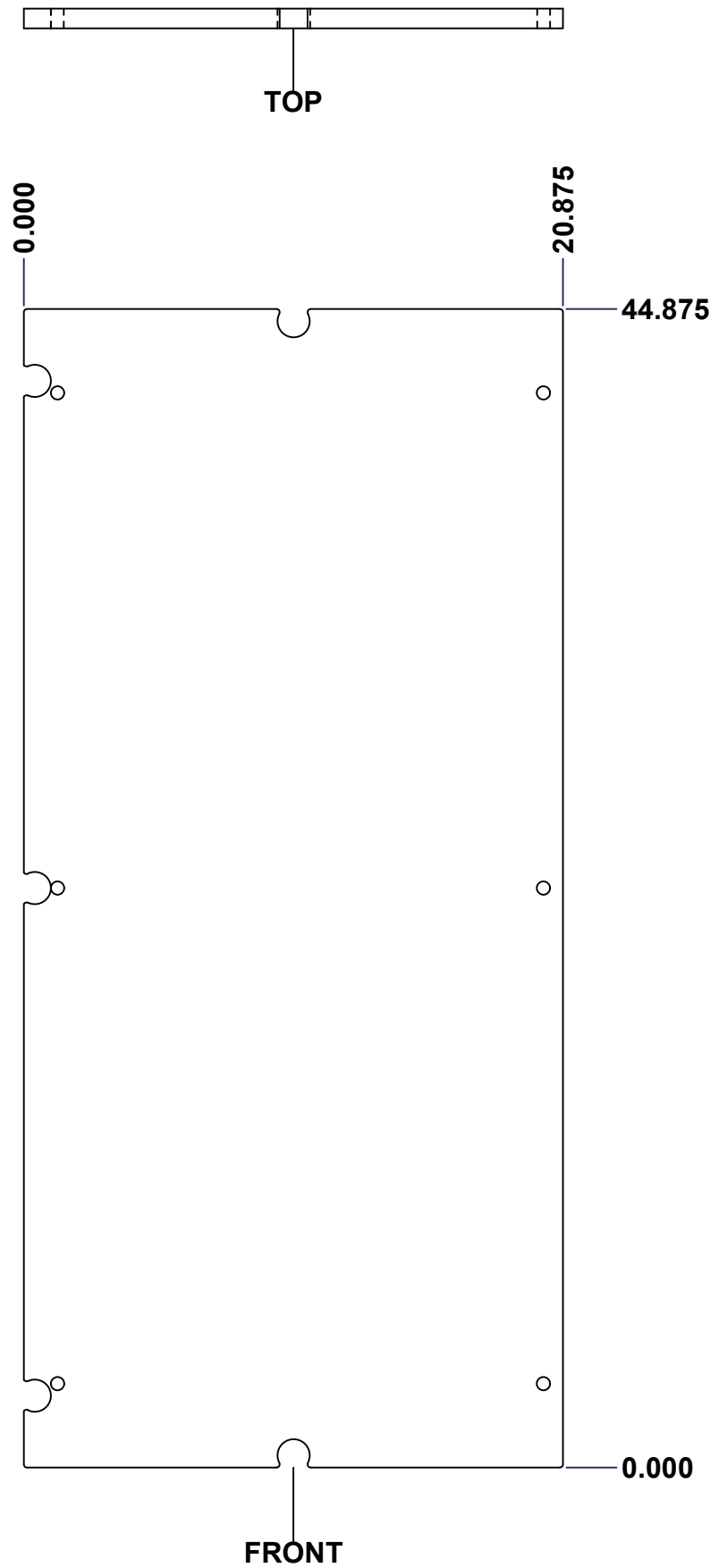

No.	Revisions	Date	By/Par

Isometric View

Tél: (450) 979-4373 Fax: (450) 979-4626 www.exmweb.com		Flatness Aplatissement Max 3.0mm Projection
Customer Client	Date	
Drawn By Dessiné Par	BoxCad: Patrick Deschenes	Date 23-Jan-07
Material Matière	Polyisocyanurate	
Color Couleur	Aluminum	Finish Fini N/A
Description	Detail Rev.	
5412ESDG 48" x 24" Cover Insulation		
Part Number Numéro Pièce	Rev.	16
5412ESDG482408THI-C	0	16

SEE BILL OF MATERIAL ON LAST PAGE

This drawing is confidential and must not be reproduced or used without the consent of EXM

Ce dessin est confidentiel et ne doit pas être reproduit ou utilisé sans le consentement de EXM

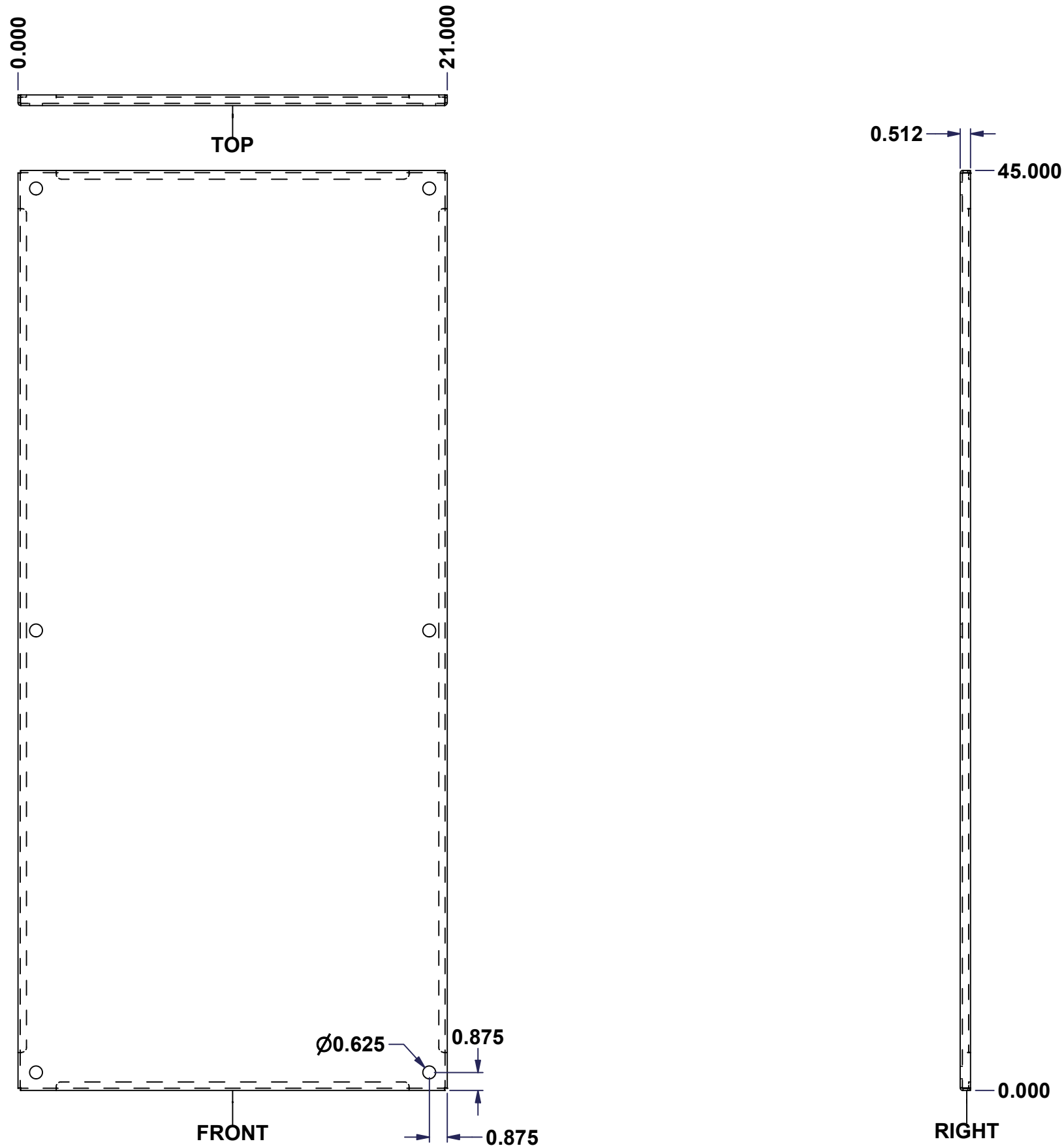

No.	Revisions	Date	By/Par

Isometric View

Tél: (450) 979-4373 Fax: (450) 979-4626 www.exmweb.com		Flatness Aplatissement Max 3.0mm Projection
Customer Client	Date	
Drawn By / Dessiné Par: BoxCad: nickz	Date: 01/03/2017	
Material / Matière: 12 Ga Galvanized (2.5mm)		
Color / Couleur: See Part List	Finish / Fini: See Part List	
Description: 885SP 48" x 24" Inner Panel Part		Detail Rev.
Part Number / Numéro Pièce: 885SP4824G	Rev.:	1

Qty	Part Number	Rev	Description	Material	Color	Finish
1	885SP4824G-P	0	885SP 48" x 24" Inner Panel Part	12 Ga Galvanized (2.5mm)	Unpainted	Galvanized

Parts List