

This drawing is confidential and must not be reproduced or used without the consent of EXM

Ce dessin est confidentiel et ne doit pas être reproduit ou utilisé sans le consentement de EXM

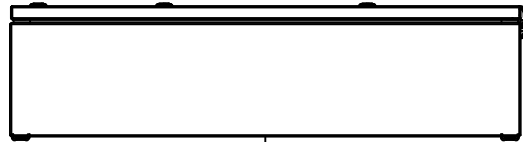

TOP

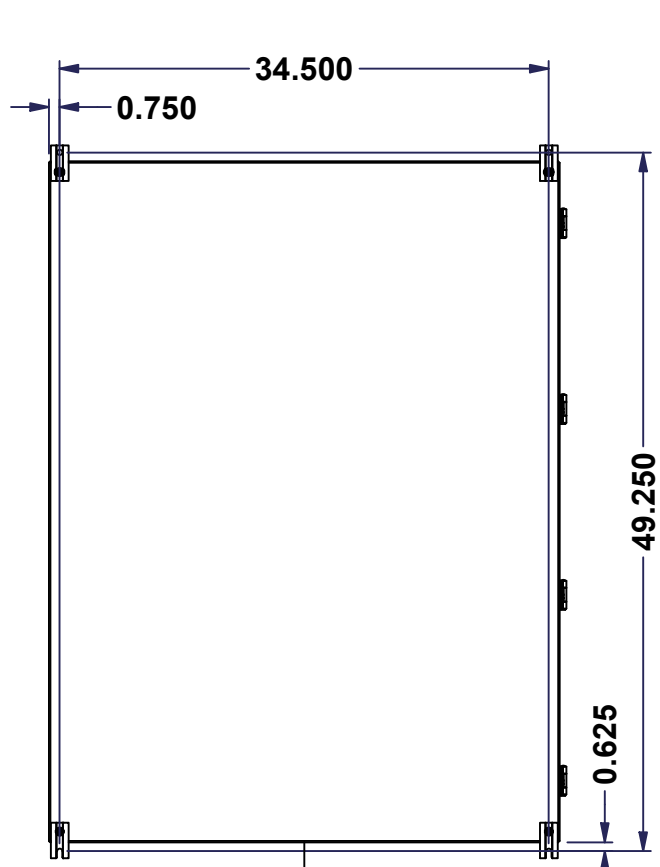

BACK

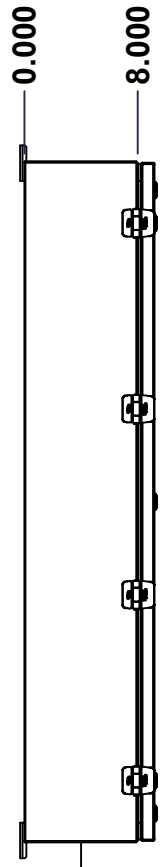

LEFT

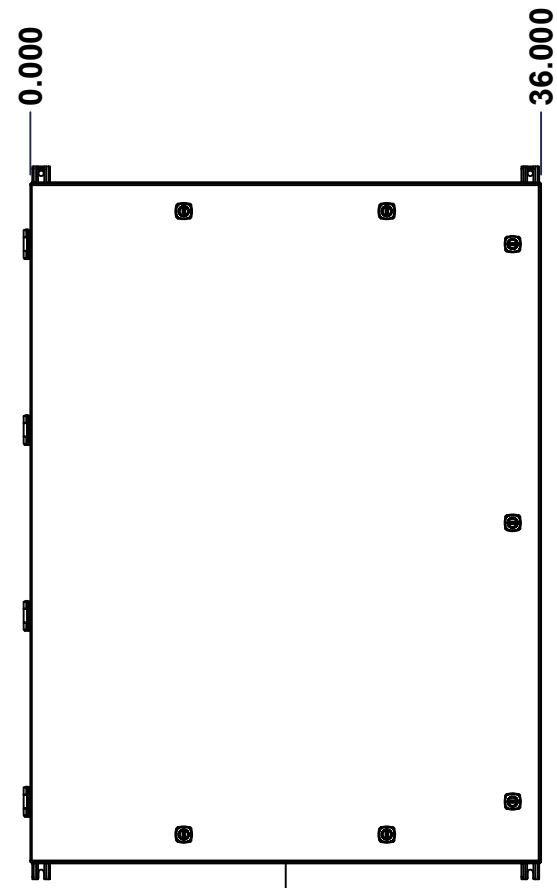

FRONT

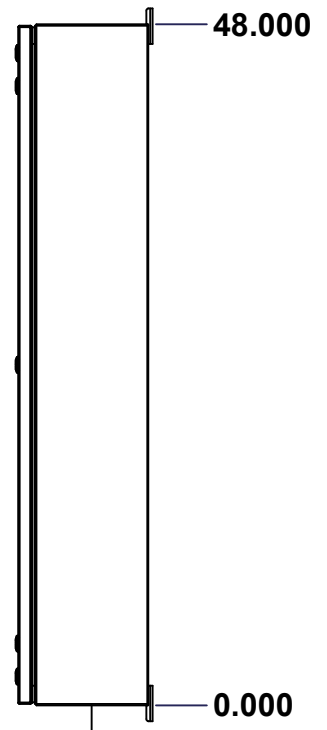

RIGHT

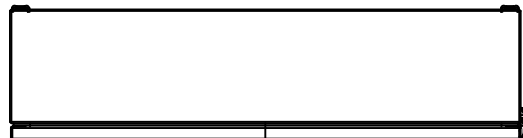

BOTTOM

| No. | Revisions | Date | By/Par |
|-----|-----------|------|--------|
|     |           |      |        |
|     |           |      |        |
|     |           |      |        |
|     |           |      |        |

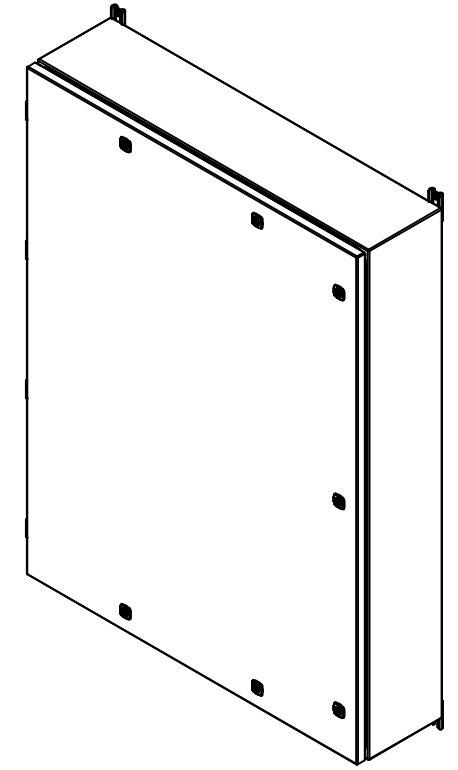

Isometric View



Tél: (450) 979-4373  
 Fax: (450) 979-4626  
[www.exmweb.com](http://www.exmweb.com)

Flatness  
Aplatissement  
Max 3.0mm  
Projection

|   |                 |
|---|-----------------|
| Customer Client   | Date            |
| Drawn By / Dessiné Par: BoxCad: BoxCad                        | Date: 03-Jan-25 |
| Material / Matière: 14 Ga Cold Rolled A1008 CS Type B (1.7mm) |                 |

|                              |                       |
|------------------------------|-----------------------|
| Color / Couleur: Asa-61 Grey | Finish / Fini: Smooth |
|------------------------------|-----------------------|

|   |             |
|---|-------------|
| Description: 5412ESDG 48" x 36" x 8" Assembly | Detail Rev. |
|---|-------------|

|  |        |   |
|--|--------|---|
| Part Number / Numéro Pièce: 5412ESDG483608TH | Rev. 0 | 1 |
|--|--------|---|

SEE BILL OF MATERIAL ON LAST PAGE

This drawing is confidential and must not be reproduced or used without the consent of EXM

Ce dessin est confidentiel et ne doit pas être reproduit ou utilisé sans le consentement de EXM

| NOTE |   |
|------|---|
| ITEM | DESCRIPTION                                     |
| 1    | NEMA 4, 12 Enclosure (IP66)                     |
| 2    | C/W Standard ground studs on box and cover      |
| 3    | C/W Standard door stiffener                     |
| 4    | C/W Standard inner panel (Included)             |
| 5    | C/W Standard inner panel mounting studs         |
| 6    | C/W 885 ESMF3_OPEN Sold separately (Installed)  |
| 7    | C/W 885 ESMF3_CLOSE Sold separately (Installed) |
| 8    | C/W R5 Insulation (Installed aluminum visible)  |

| No. | Revisions | Date | By/Par |
|-----|-----------|------|--------|
|     |           |      |        |
|     |           |      |        |
|     |           |      |        |
|     |           |      |        |
|     |           |      |        |
|     |           |      |        |

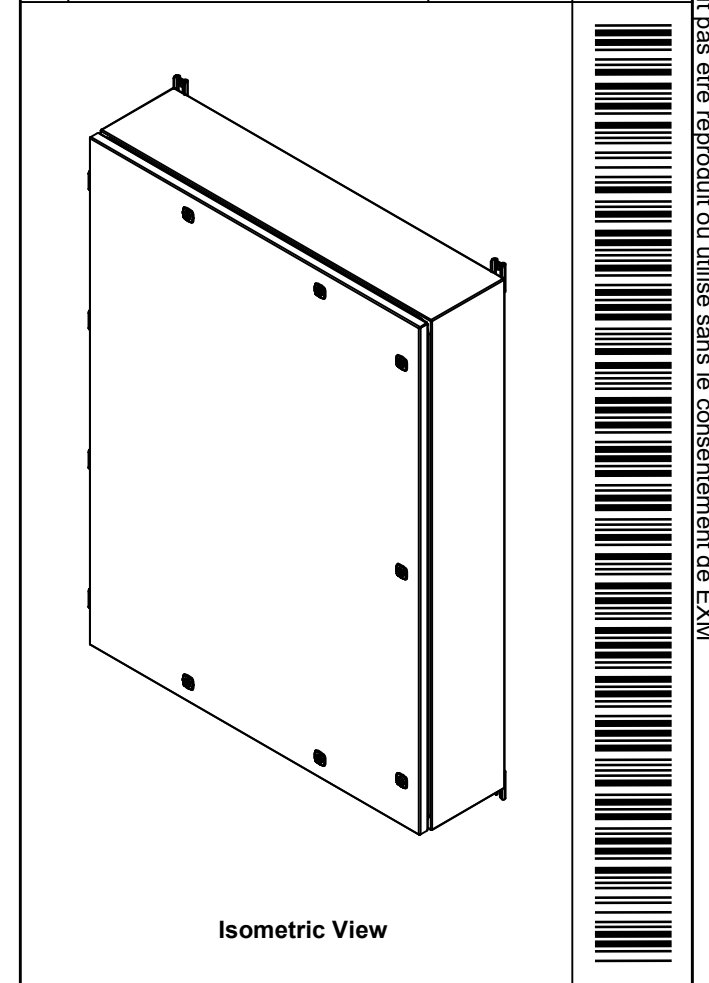

**EXM**  
www.exm.com

Tél: (450) 979-4373  
Fax: (450) 979-4626  
[www.exmweb.com](http://www.exmweb.com)

Flatness  
Aplatissement  
Max 3.0mm

Projection

|   |                |
|---|----------------|
| Customer Client   | Date           |
| Drawn By<br>Dessiné Par BoxCad: BoxCad                        | Date 03-Jan-25 |
| Material<br>Matière 14 Ga Cold Rolled A1008 CS Type B (1.7mm) |                |

|   |                       |
|---|-----------------------|
| Color<br>Couleur Asa-61 Grey                        | Finish<br>Fini Smooth |
| Description<br>5412ESDG 48" x 36" x 8" Assembly     |                       |
| Part Number<br>Numéro Pièce <b>5412ESDG483608TH</b> | Rev. <b>0</b>         |

| PACKING               |     |  |
|-----------------------|-----|--|
| ITEM                  | QTY | DESCRIPTION                                    |
| Cardboard sleeve      | 2   | Top and Bottom                                 |
| Cardboard strip       | 2   | Between back of enclosure and inner panel      |
| Plastic bag           | 1   | To protect cover surface and inside gasket     |
| Cardboard corner      | 4   | To reinforced for the plastic strap tightening |
| Plastic strap - Black | 2   | To Squeeze the 2 cardboard sleeve together     |
| Packaging label       | 3   | White label with PN                            |
| Plastic strap- Green  | 2   | To secure the enclosure to the wood pallet     |
| Wood Pallet           | 1   | 2" deeper and 3" larger than enclosure size    |

| Qty        | Part Number       | Rev | Description                       |
|------------|-------------------|-----|-----------------------------------|
| 8          | STK-Q-00600       | 2   | M12 to M8 Adaptor                 |
| 1          | 885SP4836G        | 0   | 885SP 48" x 36" Inner Panel Part  |
| 1          | STK-K-01800       | 5   | 5412 ES Accessory Kit             |
| 4          | STK-Q-10252       | 0   | M6 Stainless Steel Sealing Washer |
| 1          | 5412ESDG483608THC | 0   | 5412ESDG 48" x 36" Cover          |
| 1          | 5412ESDG483608THB | 0   | 5412ESDG 48" x 36" x 8" Body      |
| 4          | STK-Q-07220       | 1   | M6 Nylon Insert Lock Nut          |
| Parts List |                   |     |                                   |

This drawing is confidential and must not be reproduced or used without the consent of EXM

Ce dessin est confidentiel et ne doit pas être reproduit ou utilisé sans le consentement de EXM

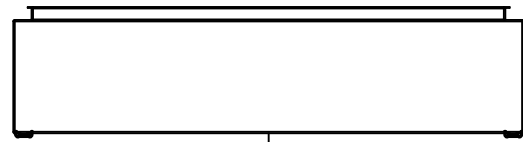

TOP

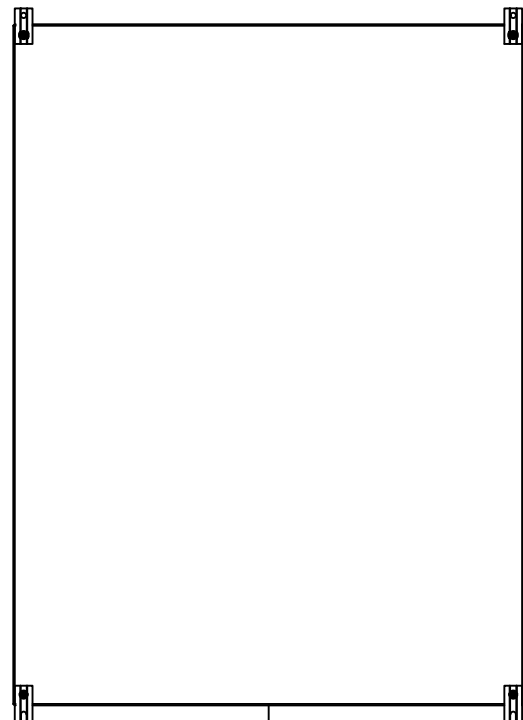

BACK

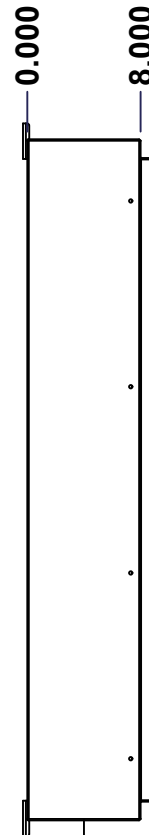

LEFT

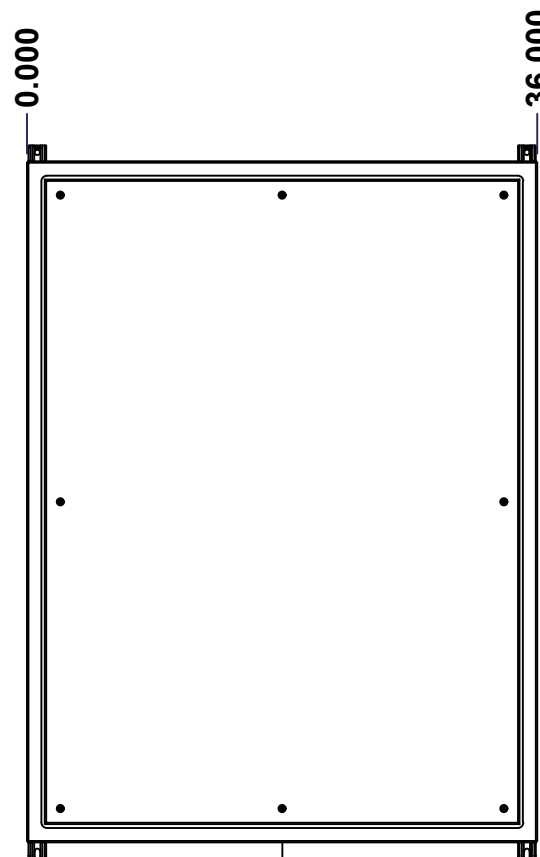

FRONT

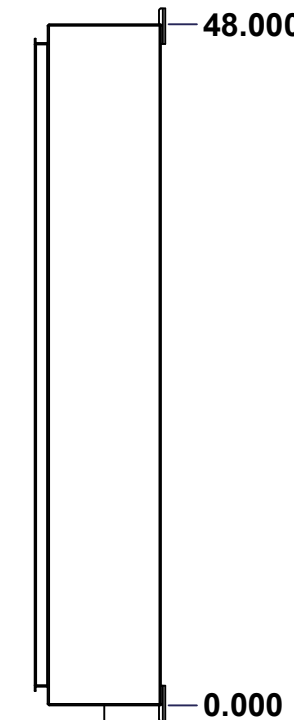

RIGHT

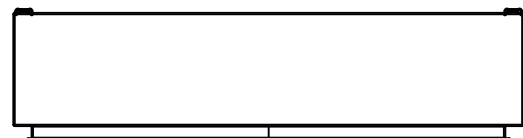

BOTTOM

| No. | Revisions | Date | By/Par |
|-----|-----------|------|--------|
|     |           |      |        |
|     |           |      |        |
|     |           |      |        |
|     |           |      |        |

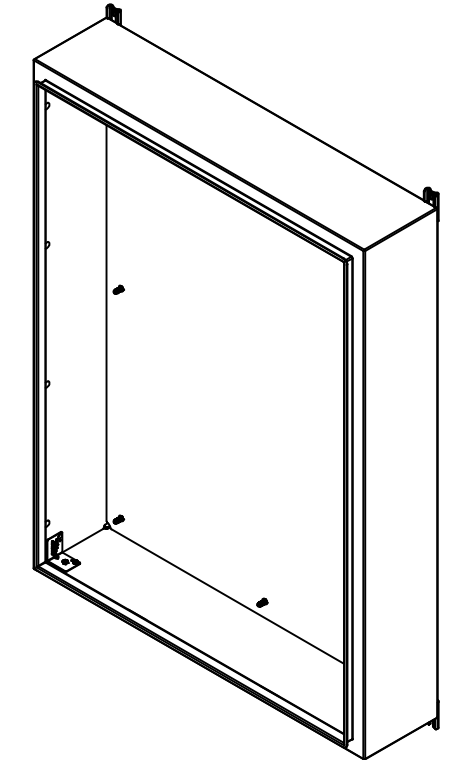

Isometric View

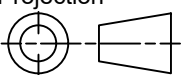

|  |   |   |
|--|---|---|
|  Tél: (450) 979-4373<br>Fax: (450) 979-4626<br><a href="http://www.exmweb.com">www.exmweb.com</a> |   | Flatness<br>Aplatissement<br>Max 3.0mm<br>Projection<br> |
| Customer Client  | Date                                      |   |
| Drawn By<br>Dessiné Par  | BoxCad: BoxCad                            | Date 03-Jan-25  |
| Material<br>Matière  | 14 Ga Cold Rolled A1008 CS Type B (1.7mm) |   |
| Color<br>Couleur   | Asa-61 Grey                               | Finish<br>Fini Smooth   |
| Description<br>5412ESDG 48" x 36" x 8" Body  |   | Detail Rev.   |
| Part Number<br>Numéro Pièce  | Rev. 0                                    | 3<br>16   |

SEE BILL OF MATERIAL ON LAST PAGE

**5412ESDG483608THB**

This drawing is confidential and must not be reproduced or used without the consent of EXM

Ce dessin est confidentiel et ne doit pas être reproduit ou utilisé sans le consentement de EXM

| STANDARD FEATURES ARE NOT LISTED IN THIS HOLE TABLE |        |       |                                |
|---|--------|-------|--------------------------------|
| HOLE TABLE - TOP VIEW (CUSTOM FEATURE ONLY)         |        |       |                                |
| CUT-OUT   | XDIM   | YDIM  | DESCRIPTION                    |
| 1   | 2.000  | 6.500 | INSUL. STUD M6 x 18mm (Inside) |
| 2   | 34.000 | 6.500 | INSUL. STUD M6 x 18mm (Inside) |

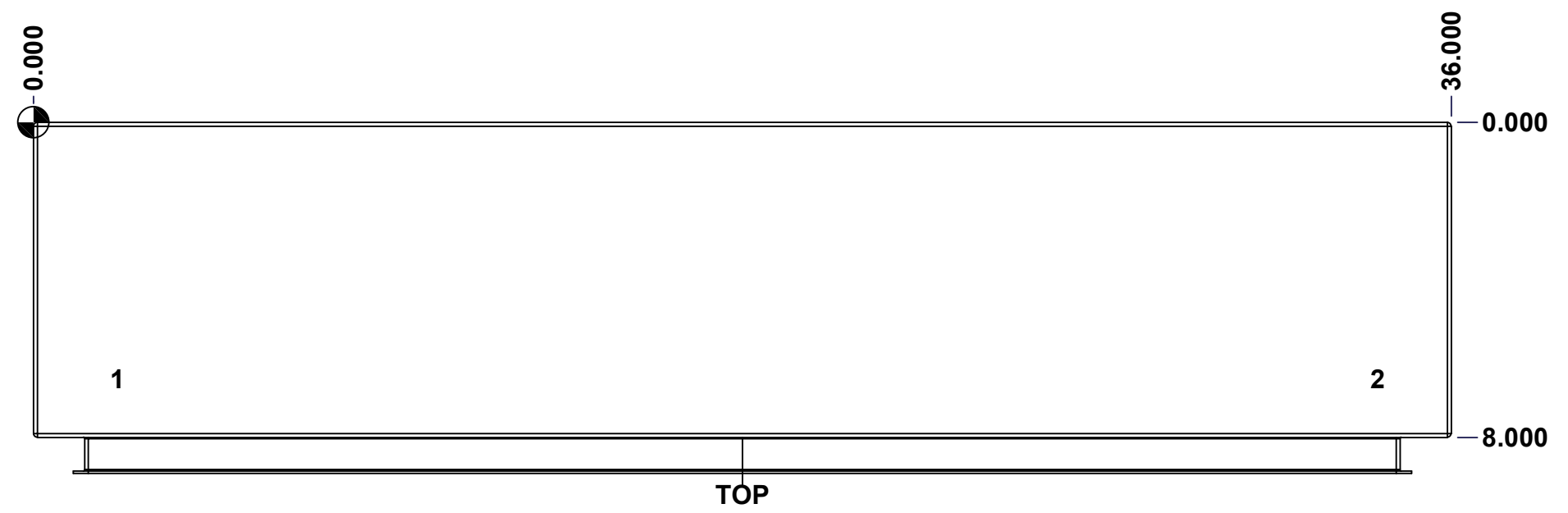

|  |                              |              |
|--|------------------------------|--------------|
|  | Description                  | Status       |
|  | 5412ESDG 48" x 36" x 8" Body | (NULL)       |
|  | Part Number<br>Numéro Pièce  | Rev.         |
|  | <b>5412ESDG483608THB</b>     | <b>0</b> / 4 |
|  |                              | 16           |

This drawing is confidential and must not be reproduced or used without the consent of EXM

Ce dessin est confidentiel et ne doit pas être reproduit ou utilisé sans le consentement de EXM

| <b>STANDARD FEATURES ARE NOT LISTED IN THIS HOLE TABLE</b> |        |       |                                |
|--|--------|-------|--------------------------------|
| <b>HOLE TABLE - BOTTOM VIEW (CUSTOM FEATURE ONLY)</b>      |        |       |                                |
| CUT-OUT  | XDIM   | YDIM  | DESCRIPTION                    |
| 1  | 2.000  | 6.500 | INSUL. STUD M6 x 18mm (Inside) |
| 2  | 34.000 | 6.500 | INSUL. STUD M6 x 18mm (Inside) |

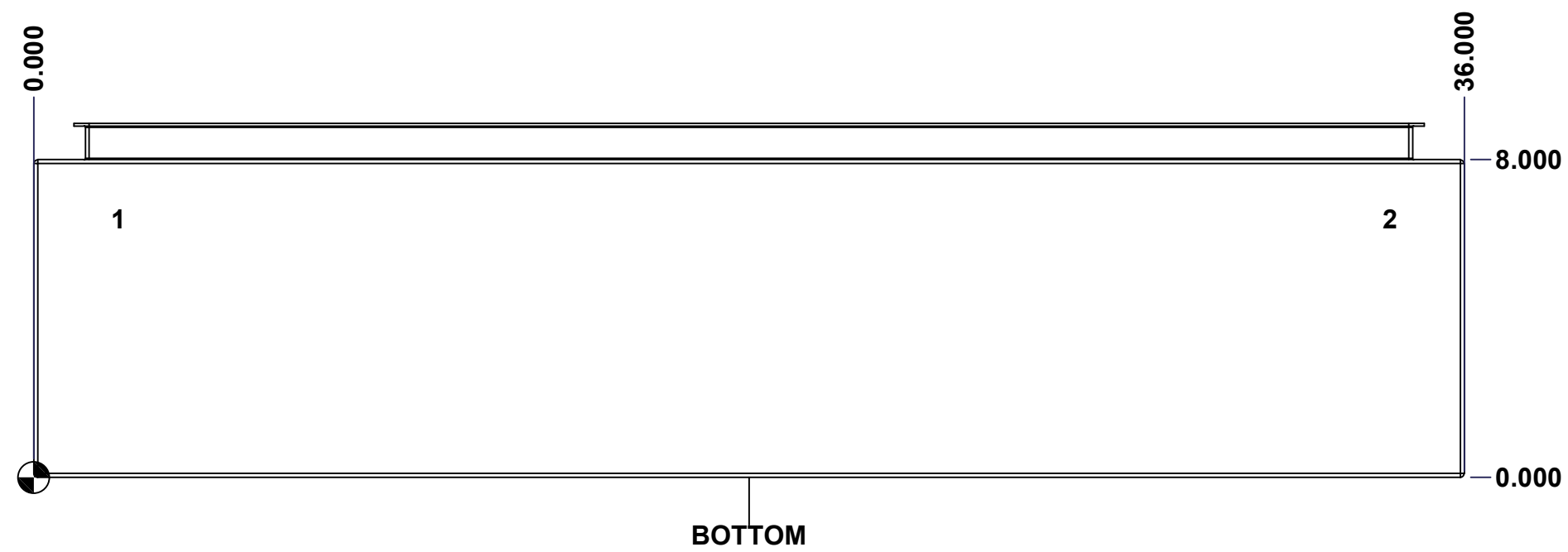

|                             |                              |        |
|-----------------------------|------------------------------|--------|
|                             | Description                  | Status |
|                             | 5412ESDG 48" x 36" x 8" Body | (NULL) |
| Part Number<br>Numéro Pièce | 5412ESDG483608THB            | Rev. 5 |
|                             |                              | 0 / 16 |

This drawing is confidential and must not be reproduced or used without the consent of EXM

Ce dessin est confidentiel et ne doit pas être reproduit ou utilisé sans le consentement de EXM

**STANDARD FEATURES ARE NOT LISTED IN THIS HOLE TABLE**

**HOLE TABLE - BACK VIEW (CUSTOM FEATURE ONLY)**

| CUT-OUT | XDIM   | YDIM   | DESCRIPTION                |
|---------|--------|--------|----------------------------|
| 1       | 2.375  | 2.375  | IP STUD M8 x 35mm (Inside) |
| 2       | 2.375  | 45.625 | IP STUD M8 x 35mm (Inside) |
| 3       | 33.625 | 45.625 | IP STUD M8 x 35mm (Inside) |
| 4       | 33.625 | 2.375  | IP STUD M8 x 35mm (Inside) |
| 5       | 2.375  | 24.000 | IP STUD M8 x 35mm (Inside) |
| 6       | 33.625 | 24.000 | IP STUD M8 x 35mm (Inside) |
| 7       | 18.000 | 2.375  | IP STUD M8 x 35mm (Inside) |
| 8       | 18.000 | 45.625 | IP STUD M8 x 35mm (Inside) |
| -----   |        |        |                            |
| 9       | 35.250 | 0.000  | FOOT 885 ESMF3_OPEN        |
| 10      | 0.750  | 0.000  | FOOT 885 ESMF3_OPEN        |
| 11      | 35.250 | 48.000 | FOOT 885 ESMF3_CLOSE       |
| 12      | 0.750  | 48.000 | FOOT 885 ESMF3_CLOSE       |

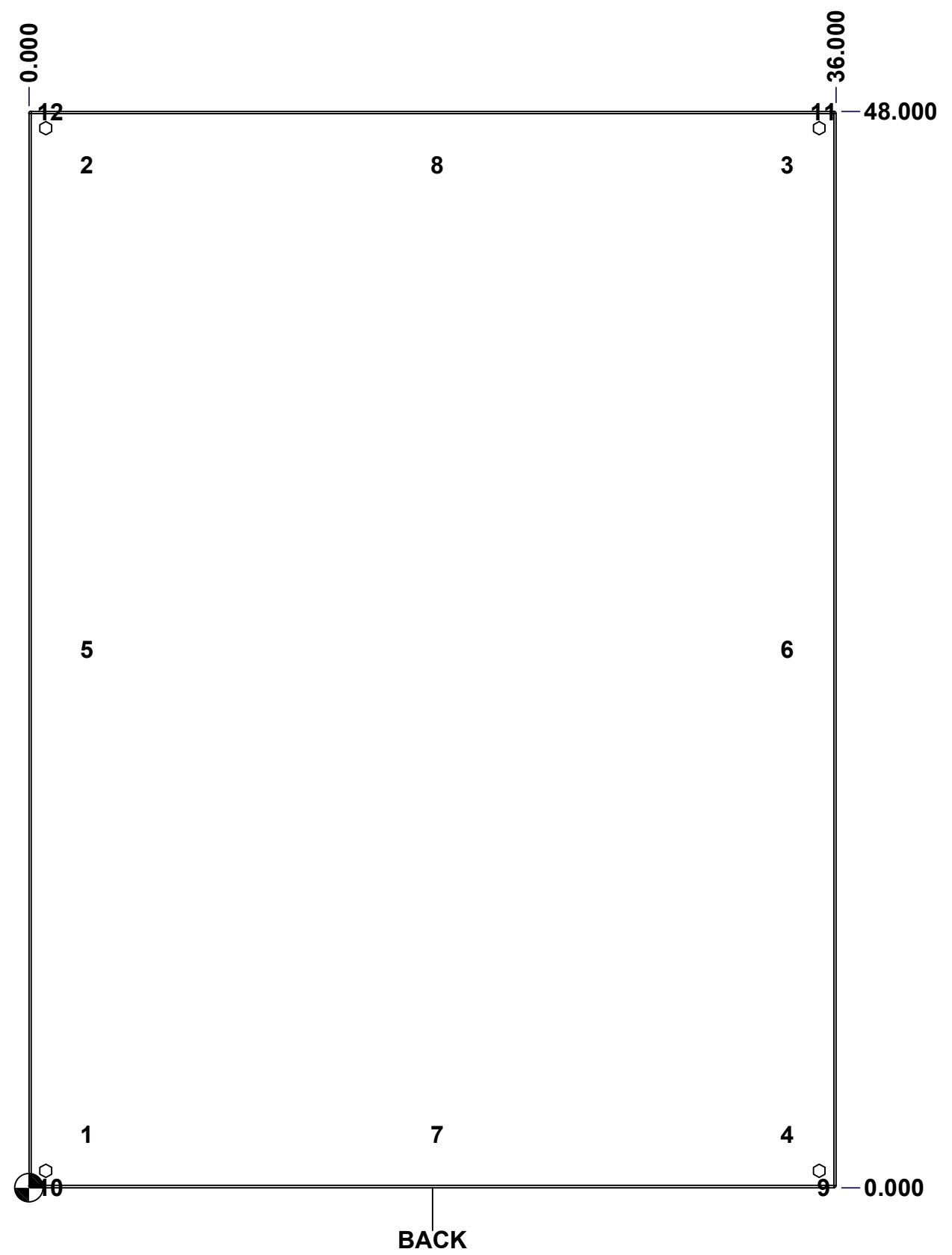

BACK

|   |                              |        |
|---|------------------------------|--------|
|   | Description                  | Status |
|   | 5412ESDG 48" x 36" x 8" Body | (NULL) |
| Part Number<br>Numéro Pièce<br><b>5412ESDG483608THB</b> | Rev.                         | 6      |
|   | <b>0</b>                     | 16     |

This drawing is confidential and must not be reproduced or used without the consent of EXM

Ce dessin est confidentiel et ne doit pas être reproduit ou utilisé sans le consentement de EXM

| No. | Revisions | Date | By/Par |
|-----|-----------|------|--------|
|     |           |      |        |
|     |           |      |        |
|     |           |      |        |
|     |           |      |        |
|     |           |      |        |

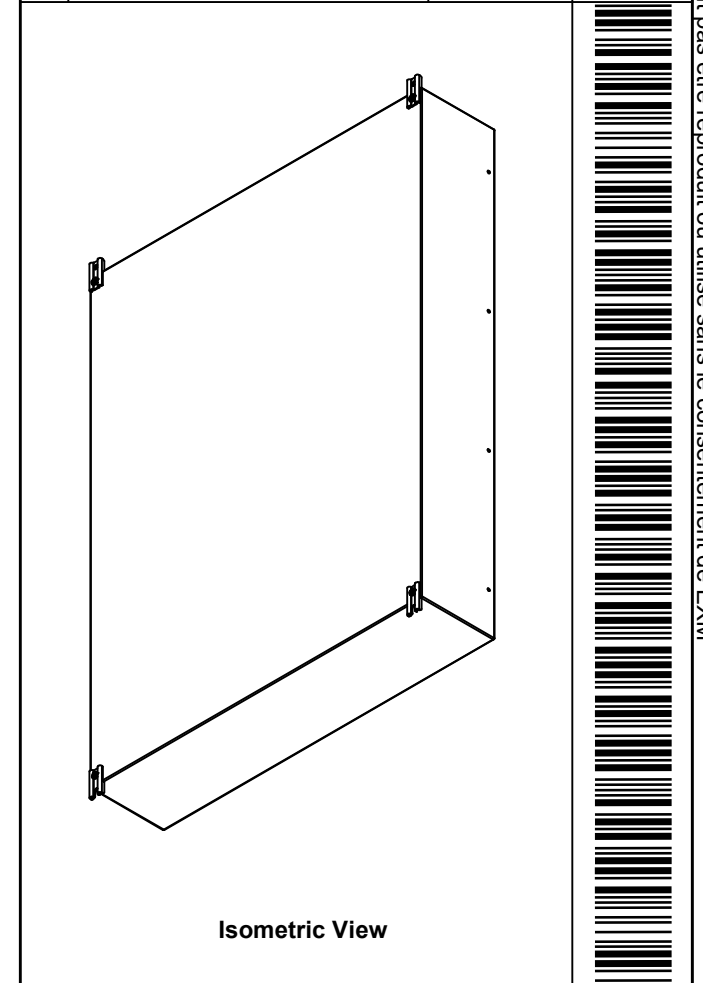

|            |                      |     |  |
|------------|----------------------|-----|--|
| 1          | 885 ESMF3            | 0   | 885 ESMF3 Mounting Foot Kit            |
| 4          | RIVET_NUT_M10_FH_CE  | 0   | Rivet Nut M10 (Low Profile Close End)  |
| 1          | STK-K-70554          | 3   | 5412 ESTH Accessory Kit                |
| 1          | 5412ESDG483608THI-RS | 0   | 5412ESDG 48" x 36" Right Insulation    |
| 1          | 5412ESDG483608THI-LS | 0   | 5412ESDG 48" x 36" Left Insulation     |
| 1          | 5412ESDG483608THI-BT | 0   | 5412ESDG 48" x 36"Bottom Insulation    |
| 1          | 5412ESDG483608THI-TP | 0   | 5412ESDG 48" x 36"Top Insulation       |
| 1          | 5412ESDG483608THI-B  | 0   | 5412ESDG 48" x 36" Back Insulation     |
| 4          | STK-Q-16055          | 1   | M6 x 18mm Stud (No Paint Cap Required) |
| 1          | STK-P-02400S         | 0   | Powder Paint (Asa-61 Grey / Smooth)    |
| 8          | STK-Q-16005          | 0   | Stud M8 x 35mm Steel                   |
| 1          | 5412ESDG483608THB-P  | 0   | 5412ESDG 48" x 36" x 8" Body Part      |
| Qty        | Part Number          | Rev | Description                            |
| Parts List |                      |     |  |

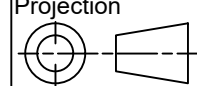
|  |                       |  |
|--|-----------------------|--|
|  Tél: (450) 979-4373<br>Fax: (450) 979-4626<br><a href="http://www.exmweb.com">www.exmweb.com</a> |                       | Flatness<br>Aplatissement<br>Max 3.0mm |
| Projection<br>  |                       | Customer<br>Client                     |
| Drawn By<br>Dessiné Par BoxCad: BoxCad   |                       | Date<br>03-Jan-25                      |
| Material<br>Matière 14 Ga Cold Rolled A1008 CS Type B (1.7mm)  |                       |  |
| Color<br>Couleur Asa-61 Grey   | Finish<br>Fini Smooth |  |
| Description<br>5412ESDG 48" x 36" x 8" Body  |                       | Detail Rev.                            |
| Part Number<br>Numéro Pièce<br><b>5412ESDG483608THB</b>  |                       | Rev. 7<br><b>0</b>                     |
|  |                       | 16                                     |

This drawing is confidential and must not be reproduced or used without the consent of EXM

Ce dessin est confidentiel et ne doit pas être reproduit ou utilisé sans le consentement de EXM

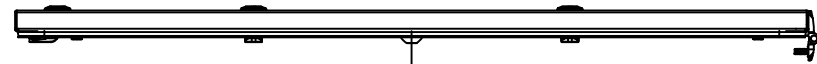

TOP

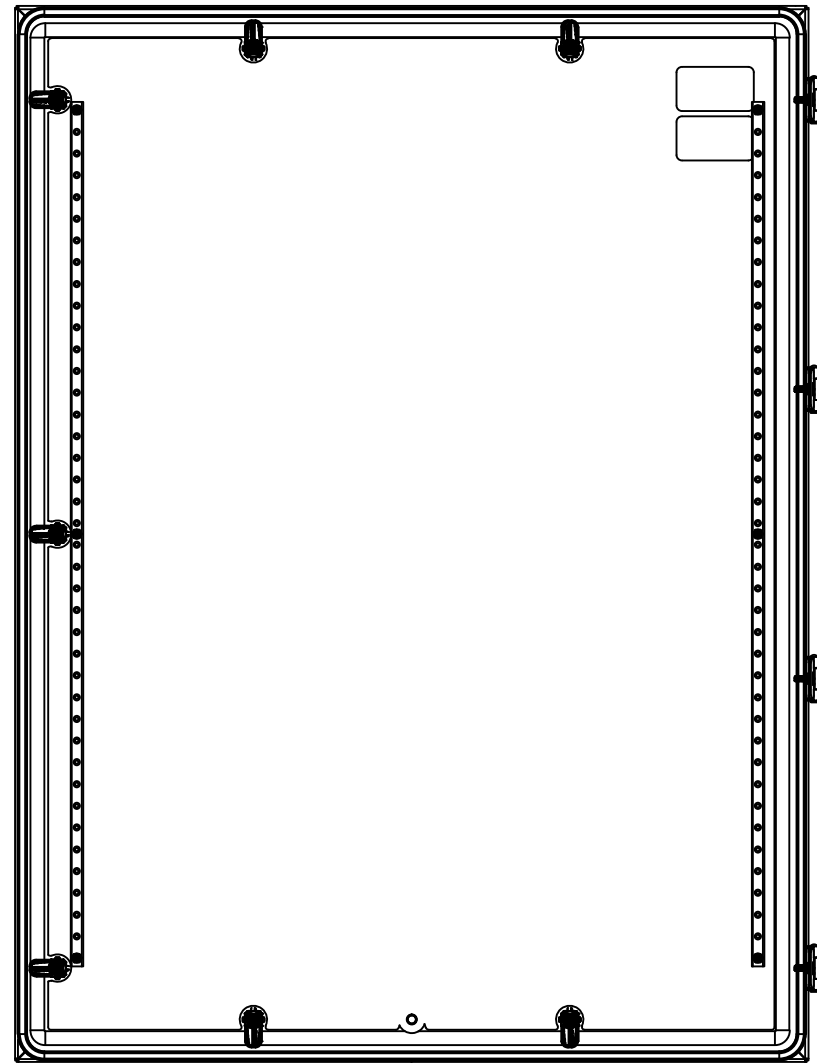

BACK



BOTTOM

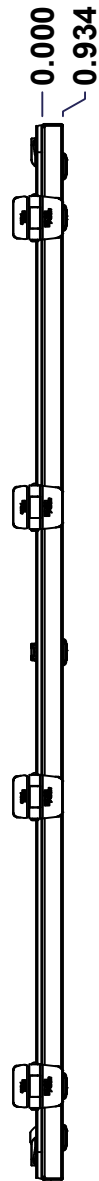

LEFT

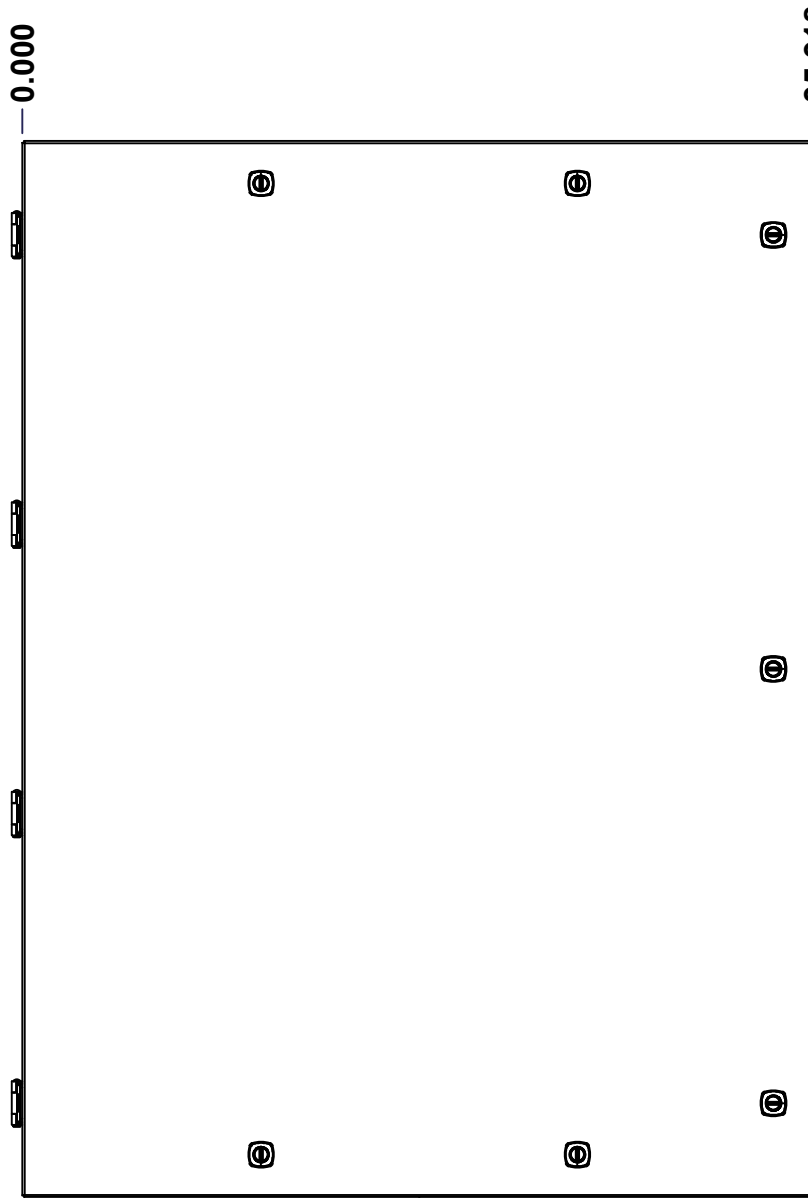

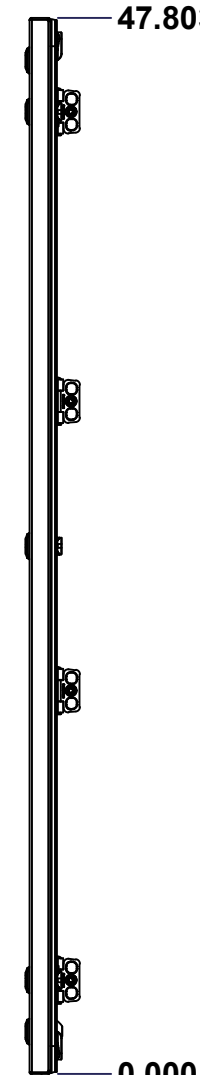

FRONT

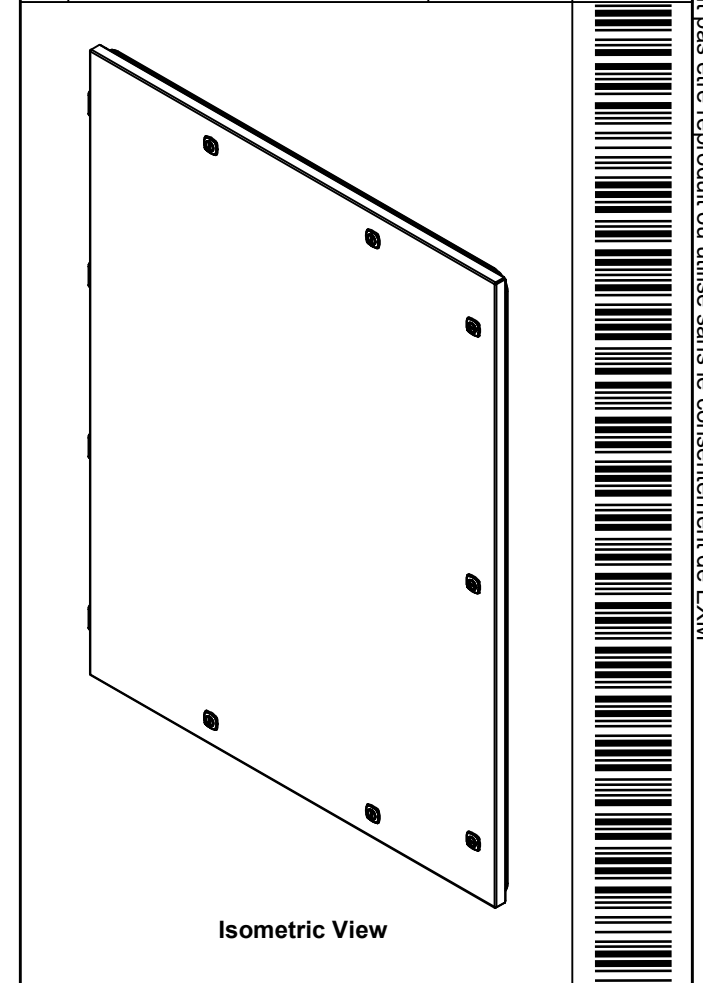

RIGHT

| No. | Revisions | Date | By/Par |
|-----|-----------|------|--------|
|     |           |      |        |
|     |           |      |        |
|     |           |      |        |
|     |           |      |        |
|     |           |      |        |



|  |  |                           |             |
|--|--|---------------------------|-------------|
|  Tél: (450) 979-4373<br>Fax: (450) 979-4626<br><a href="http://www.exmweb.com">www.exmweb.com</a> |  | Flatness<br>Aplatissement |             |
|  |  | Max 3.0mm                 |             |
| Customer<br>Client   |  | Date                      |             |
| Drawn By<br>Dessiné Par BoxCad: BoxCad   |  | Date 03-Jan-25            |             |
| Material<br>Matière 14 Ga Cold Rolled A1008 CS Type B (1.7mm)  |  |                           |             |
| Color<br>Couleur Asa-61 Grey   |  | Finish<br>Fini Smooth     |             |
| Description<br>5412ESDG 48" x 36" Cover  |  |                           | Detail Rev. |
| Part Number<br>Numéro Pièce <b>5412ESDG483608THC</b>   |  | Rev. <b>0</b>             | 8 / 16      |

SEE BILL OF MATERIAL ON LAST PAGE

This drawing is confidential and must not be reproduced or used without the consent of EXM

Ce dessin est confidentiel et ne doit pas être reproduit ou utilisé sans le consentement de EXM

**STANDARD FEATURES ARE NOT LISTED IN THIS HOLE TABLE**

**HOLE TABLE - FRONT VIEW (CUSTOM FEATURE ONLY)**

| CUT-OUT | XDIM   | YDIM   | DESCRIPTION               |
|---------|--------|--------|---------------------------|
| 1       | 2.286  | 4.709  | STUD M6 x 18mm (Inside)   |
| 2       | 2.286  | 43.094 | STUD M6 x 18mm (Inside)   |
| 3       | 33.117 | 43.094 | STUD M6 x 18mm (Inside)   |
| 4       | 33.117 | 4.709  | STUD M6 x 18mm (Inside)   |
| 5       | 2.286  | 23.902 | STUD M6 x 18mm (Inside)   |
| 6       | 33.117 | 23.902 | STUD M6 x 18mm (Inside)   |
| 7       | 17.959 | 1.935  | STUD M6 x 18mm (Inside)   |
| -----   |        |        |                           |
| 8       | 33.994 | 43.553 | LOCK 880 SCQ4-SL @ 0.0°   |
| 9       | 33.994 | 23.902 | LOCK 880 SCQ4-SL @ 0.0°   |
| 10      | 33.994 | 4.250  | LOCK 880 SCQ4-SL @ 0.0°   |
| 11      | 10.800 | 45.879 | LOCK 880 SCQ4-SL @ 90.0°  |
| 12      | 25.118 | 45.879 | LOCK 880 SCQ4-SL @ 90.0°  |
| 13      | 10.800 | 1.924  | LOCK 880 SCQ4-SL @ 270.0° |
| 14      | 25.118 | 1.924  | LOCK 880 SCQ4-SL @ 270.0° |

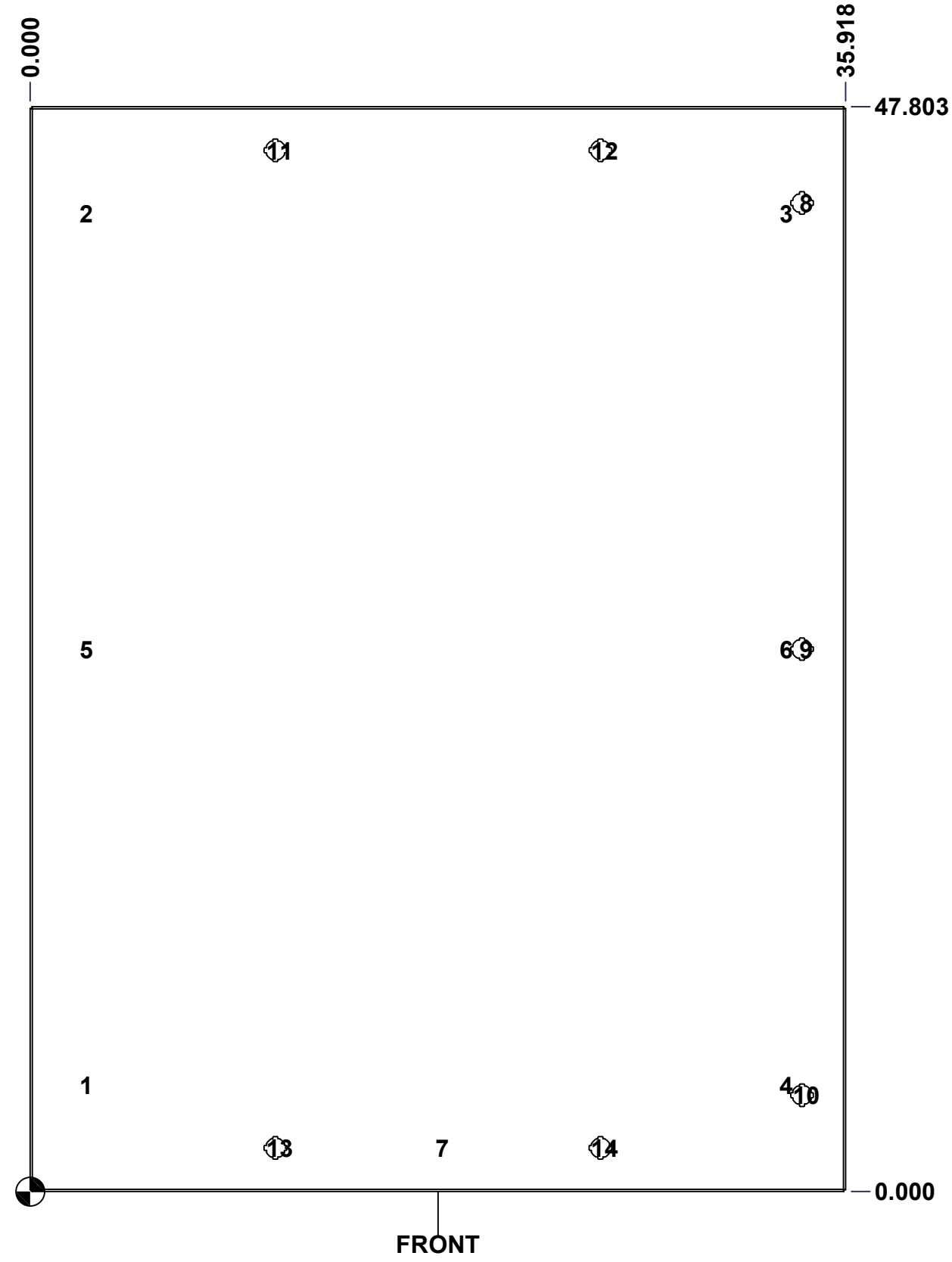

FRONT

|  |                             |              |
|--|-----------------------------|--------------|
|  | Description                 | Status       |
|  | 5412ESDG 48" x 36" Cover    | (NULL)       |
|  | Part Number<br>Numéro Pièce | Rev.         |
|  | <b>5412ESDG483608THC</b>    | <b>0</b> / 9 |
|  |                             | 16           |

This drawing is confidential and must not be reproduced or used without the consent of EXM

Ce dessin est confidentiel et ne doit pas être reproduit ou utilisé sans le consentement de EXM

| No. | Revisions | Date | By/Par |
|-----|-----------|------|--------|
|     |           |      |        |
|     |           |      |        |
|     |           |      |        |
|     |           |      |        |
|     |           |      |        |

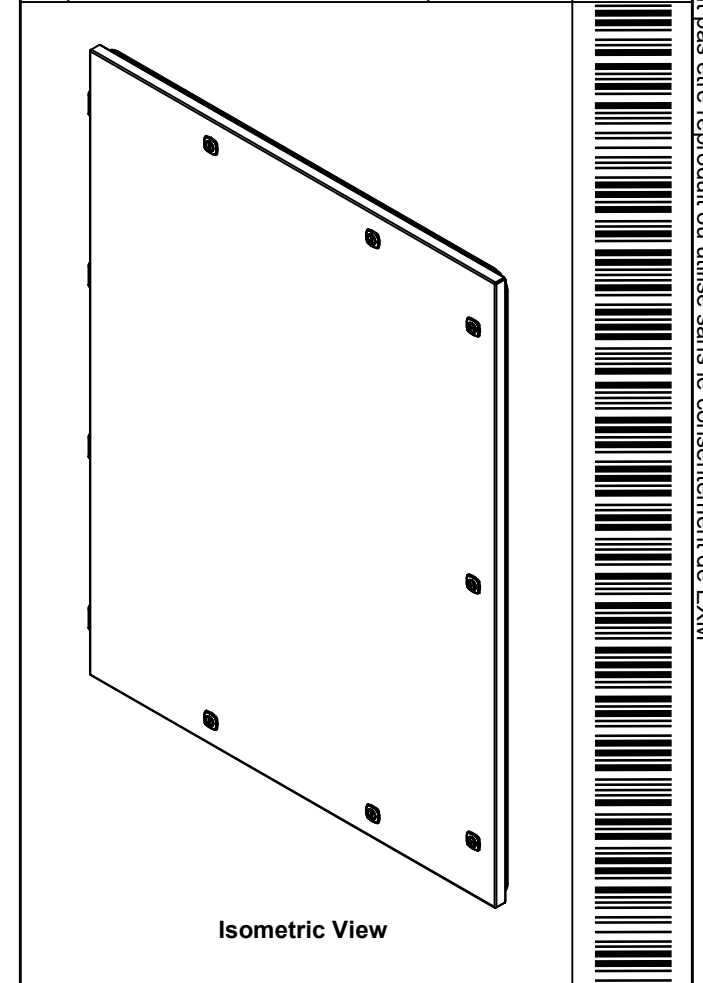

| 7          | STK-K-12500         | 19  | 5412 ES 1/4 Turn Lock                  |
|------------|---------------------|-----|--|
| 2          | STK-S-00100         | 0   | 3.5" x 2" Silver Milar Flexcon Sticker |
| 6          | STK-Q-07250         | 2   | M6 x 16mm Collar Nut                   |
| 2          | STK-Q-46020-42      | 6   | 5412 ES Vertical Door Stiffener 42"    |
| 1          | 5412ESDG483608THI-C | 0   | 5412ESDG 48" x 36" Cover Insulation    |
| 1          | STK-P-02400S        | 0   | Powder Paint (Asa-61 Grey / Smooth)    |
| 1          | STK-Q-46515         | 3   | 5412 ES Door Support with Brass Insert |
| 7          | STK-Q-16055         | 1   | M6 x 18mm Stud (No Paint Cap Required) |
| 1          | 5412ESDG483608THG2  | 0   | 5412ESDG 48" x 36" Cover Gasket        |
| 1          | 5412ESDG483608THG   | 0   | 5412ESDG 48" x 36" Cover Gasket        |
| 1          | 5412ESDG483608THC-P | 0   | 5412ESDG 48" x 36" Cover Part          |
| 4          | STK-A-02360         | 0   | External Hinge for Double Gasket       |
| 4          | STK-Q-07220         | 1   | M6 Nylon Insert Lock Nut               |
| 4          | STK-Q-10252         | 0   | M6 Stainless Steel Sealing Washer      |
| QTY        | Part Number         | Rev | Description                            |
| Parts List |                     |     |  |

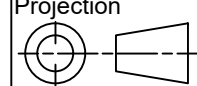
|  |   |   |
|--|---|---|
|  Tél: (450) 979-4373<br>Fax: (450) 979-4626<br><a href="http://www.exmweb.com">www.exmweb.com</a> | Flatness<br>Aplatissement                 | Max 3.0mm   |
|  | Projection                                |  |
| Customer<br>Client   | Date                                      |   |
| Drawn By<br>Dessiné Par  | BoxCad: BoxCad                            | Date 03-Jan-25  |
| Material<br>Matière  | 14 Ga Cold Rolled A1008 CS Type B (1.7mm) |   |
| Color<br>Couleur   | Asa-61 Grey                               | Finish<br>Fini Smooth   |
| Description  | Detail Rev.                               |   |
| 5412ESDG 48" x 36" Cover   |   |   |
| Part Number<br>Numéro Pièce  | Rev. 0                                    | 10 / 16   |
| <b>5412ESDG483608THC</b>   |   |   |

This drawing is confidential and must not be reproduced or used without the consent of EXM

Ce dessin est confidentiel et ne doit pas être reproduit ou utilisé sans le consentement de EXM

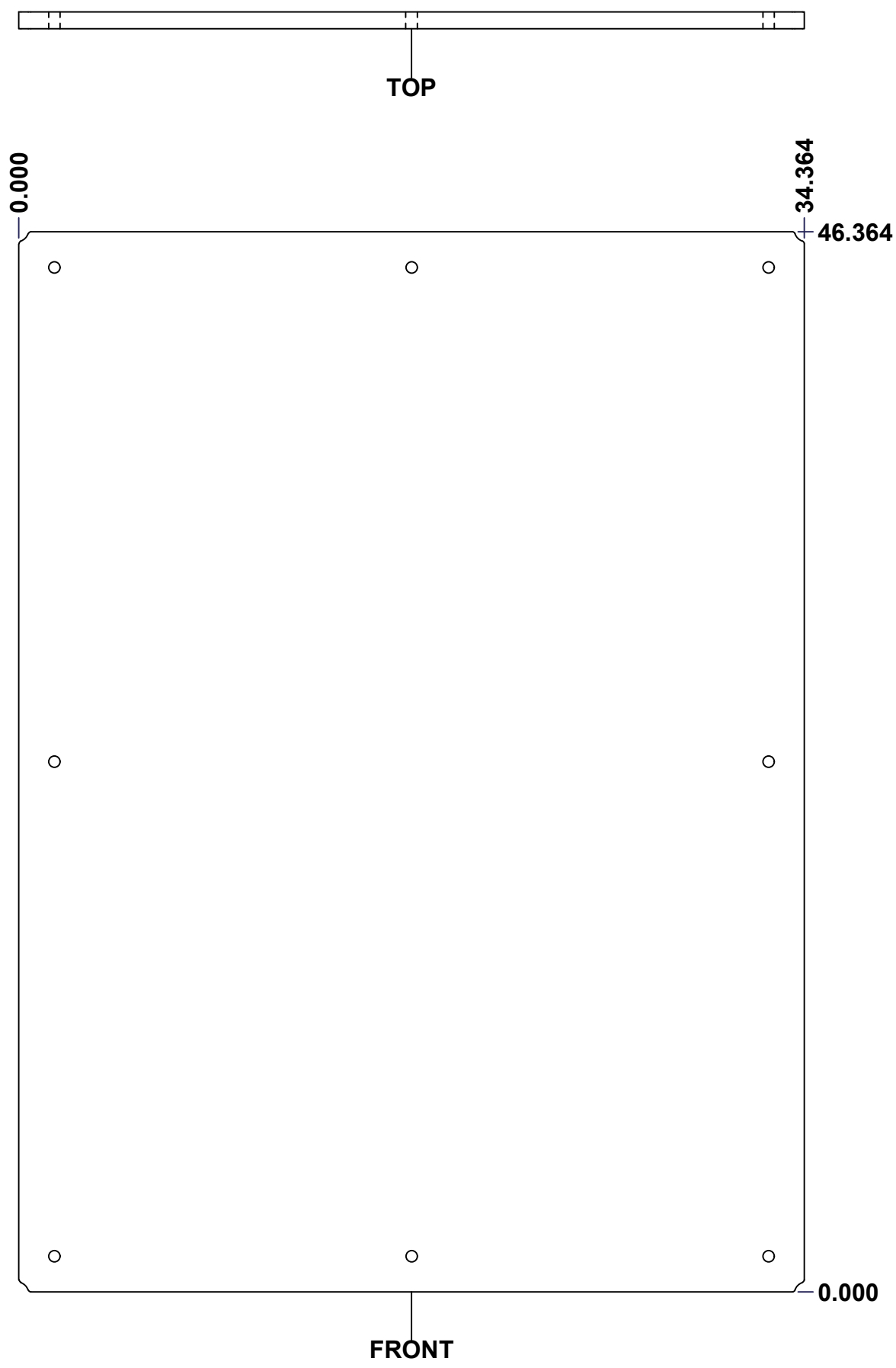

| No. | Revisions | Date | By/Par |
|-----|-----------|------|--------|
|     |           |      |        |
|     |           |      |        |
|     |           |      |        |
|     |           |      |        |

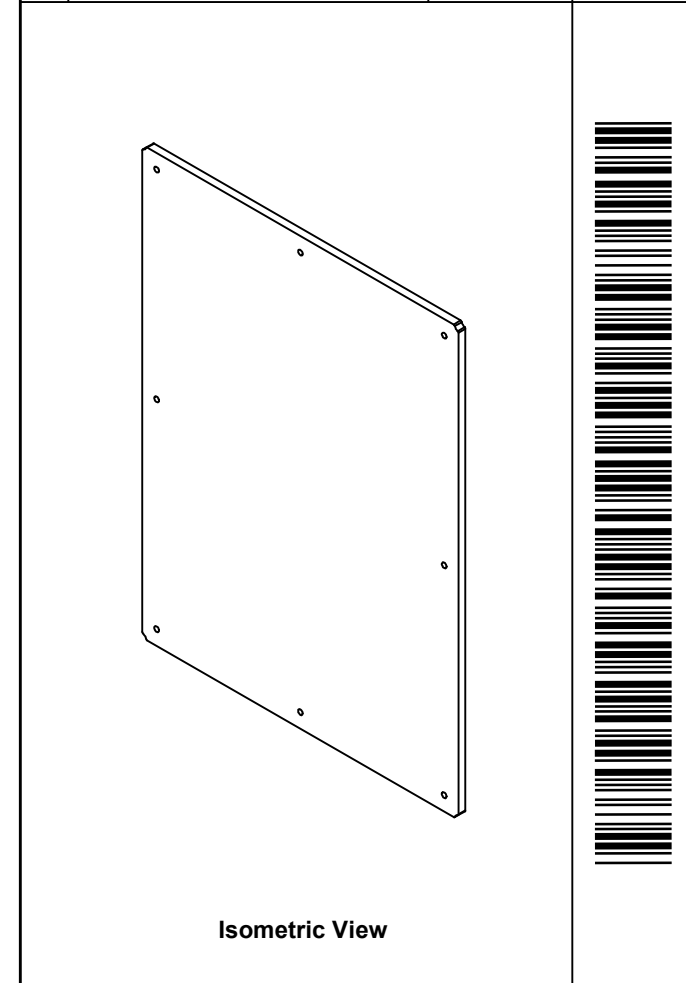

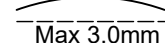
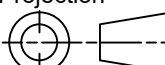
|  |                    |   |
|--|--------------------|---|
|  Tél: (450) 979-4373<br>Fax: (450) 979-4626<br><a href="http://www.exmweb.com">www.exmweb.com</a> |                    | Flatness<br>Aplatissement<br><br>Max 3.0mm |
| Customer Client  |                    | Projection<br>                             |
| Drawn By / Dessiné Par: BoxCad: Patrick Deschenes  |                    | Date: 23-Jan-07   |
| Material / Matière: Polyisocyanurate   |                    |   |
| Color / Couleur: Aluminum  | Finish / Fini: N/A |   |
| Description: 5412ESDG 48" x 36" Back Insulation  |                    | Detail Rev.   |
| Part Number / Numéro Pièce: 5412ESDG483608THI-B  |                    | Rev. 11<br>0 16   |

SEE BILL OF MATERIAL ON LAST PAGE

This drawing is confidential and must not be reproduced or used without the consent of EXM

Ce dessin est confidentiel et ne doit pas être reproduit ou utilisé sans le consentement de EXM

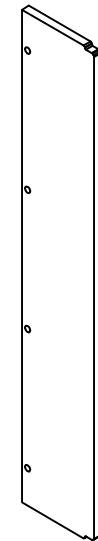
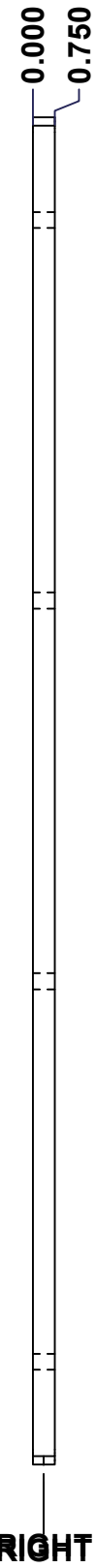
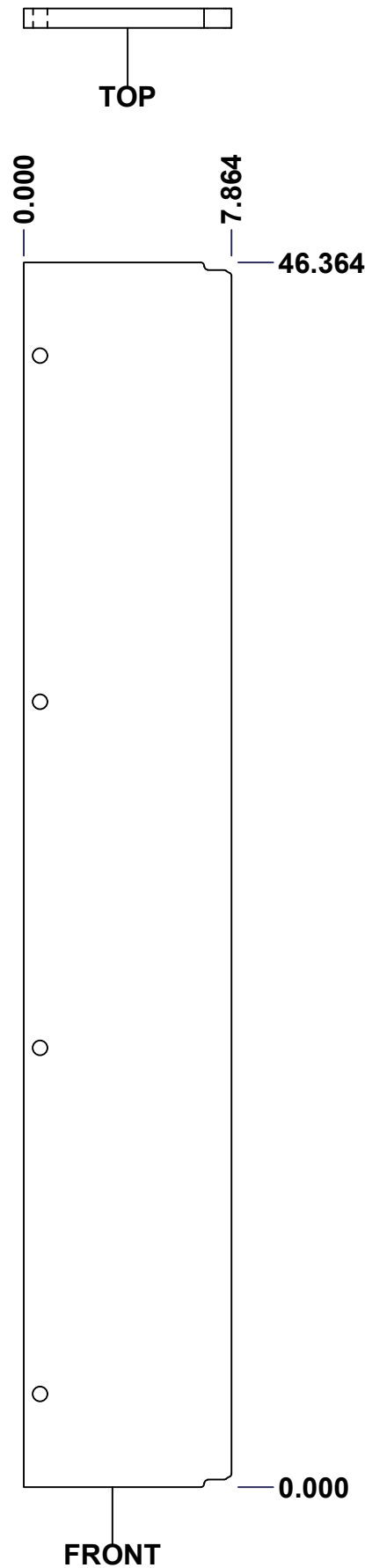

Isometric View

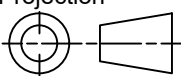

| No. | Revisions | Date | By/Par |
|-----|-----------|------|--------|
|     |           |      |        |
|     |           |      |        |
|     |           |      |        |
|     |           |      |        |
|     |           |      |        |

|  |                           |  |
|--|---------------------------|--|
|  Tél: (450) 979-4373<br>Fax: (450) 979-4626<br><a href="http://www.exmweb.com">www.exmweb.com</a> |                           | Flatness<br>Aplatissement<br>Max 3.0mm |
| Projection<br>  |                           | Date<br>23-Jan-07                      |
| Customer Client  | Date                      |  |
| Drawn By<br>Dessiné Par  | BoxCad: Patrick Deschenes | Date 23-Jan-07                         |
| Material<br>Matière  | Polyisocyanurate          |  |
| Color<br>Couleur   | Aluminum                  | Finish<br>Fini N/A                     |
| Description  | Detail Rev.               |  |
| 5412ESDG 48" x 36" Left Insulation   |                           |  |
| Part Number<br>Numéro Pièce  | Rev. 0                    | 12 / 16                                |
| <b>5412ESDG483608THI-LS</b>  |                           |  |

SEE BILL OF MATERIAL ON LAST PAGE

This drawing is confidential and must not be reproduced or used without the consent of EXM

Ce dessin est confidentiel et ne doit pas être reproduit ou utilisé sans le consentement de EXM

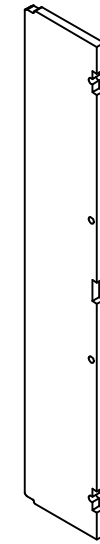
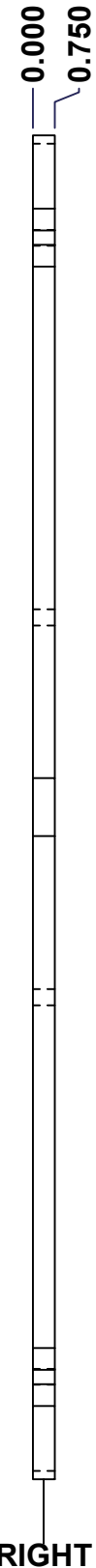
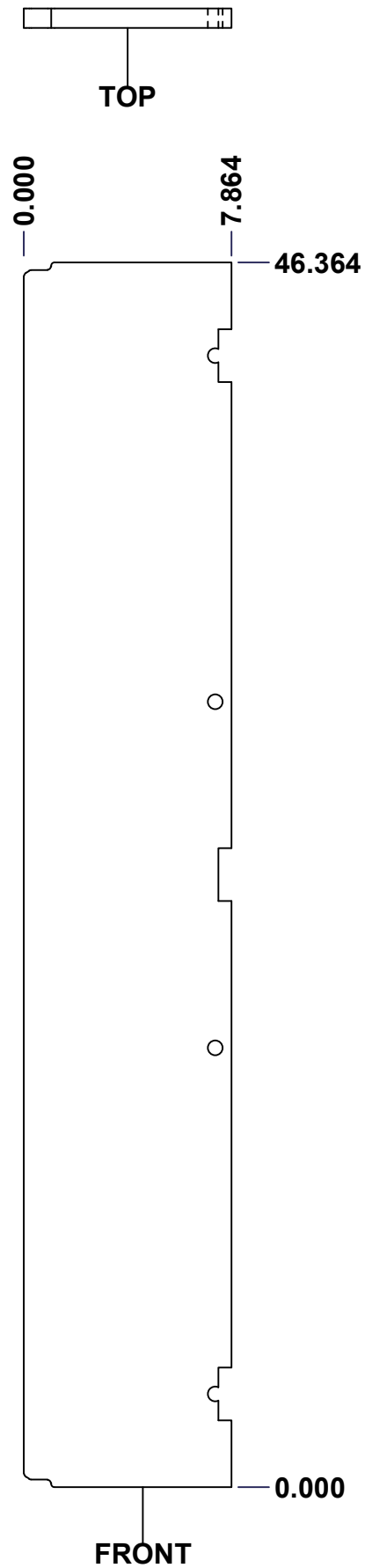

Isometric View



Tél: (450) 979-4373  
 Fax: (450) 979-4626  
[www.exmweb.com](http://www.exmweb.com)

Flatness  
Aplatissement

Max 3.0mm

Projection

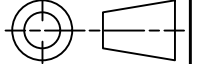

|                         |                  |
|-------------------------|------------------|
| Customer Client         | Date             |
| Drawn By<br>Dessiné Par | Date 23-Jan-07   |
| Material<br>Matière     | Polyisocyanurate |
| Color<br>Couleur        | Aluminum         |
| Finish<br>Fini          | N/A              |

|                                     |             |
|-------------------------------------|-------------|
| Description                         | Detail Rev. |
| 5412ESDG 48" x 36" Right Insulation |             |

|                             |          |    |
|-----------------------------|----------|----|
| Part Number<br>Numéro Pièce | Rev.     | 13 |
| <b>5412ESDG483608TH-RS</b>  | <b>0</b> | 16 |

SEE BILL OF MATERIAL ON LAST PAGE

This drawing is confidential and must not be reproduced or used without the consent of EXM

Ce dessin est confidentiel et ne doit pas être reproduit ou utilisé sans le consentement de EXM

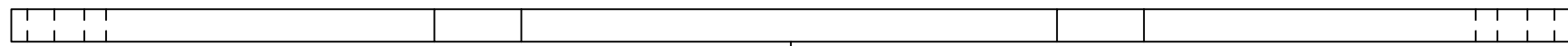

TOP

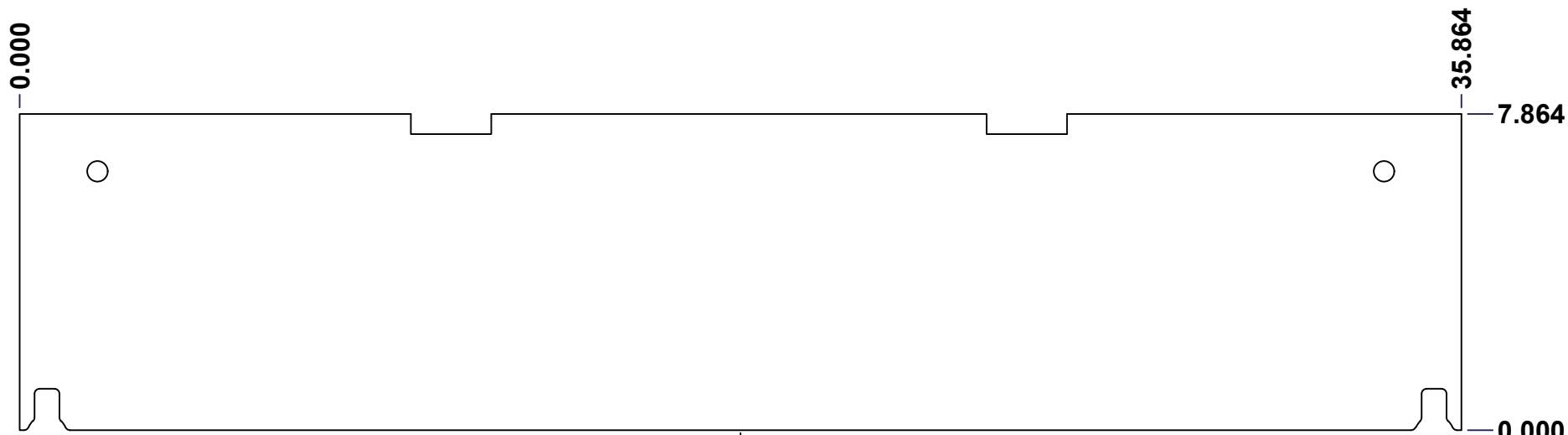

FRONT

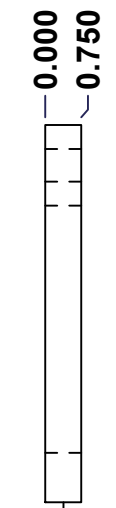

RIGHT

| No. | Revisions | Date | By/Par |
|-----|-----------|------|--------|
|     |           |      |        |
|     |           |      |        |
|     |           |      |        |
|     |           |      |        |
|     |           |      |        |

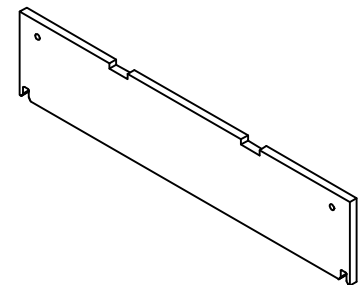

Isometric View



Tél: (450) 979-4373  
 Fax: (450) 979-4626  
[www.exmweb.com](http://www.exmweb.com)

Flatness  
Aplatissement  
Max 3.0mm  
Projection

|  |                       |
|--|-----------------------|
| Customer Client                                  | Date                  |
| Drawn By / Dessiné Par: BoxCad: BoxCad           | Date: 4/3/2024        |
| Material / Matière: Polyisocyanurate             |                       |
| Color / Couleur: Aluminum                        | Finish / Fini: Smooth |
| Description: 5412ESDG 48" x 36"Top Insulation    | Detail Rev.           |
| Part Number / Numéro Pièce: 5412ESDG483608THI-TP | Rev. 0                |

SEE BILL OF MATERIAL ON LAST PAGE

This drawing is confidential and must not be reproduced or used without the consent of EXM

Ce dessin est confidentiel et ne doit pas être reproduit ou utilisé sans le consentement de EXM

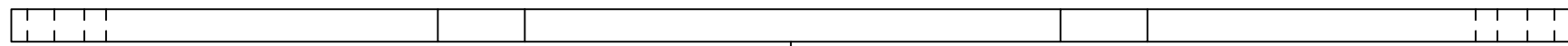

TOP

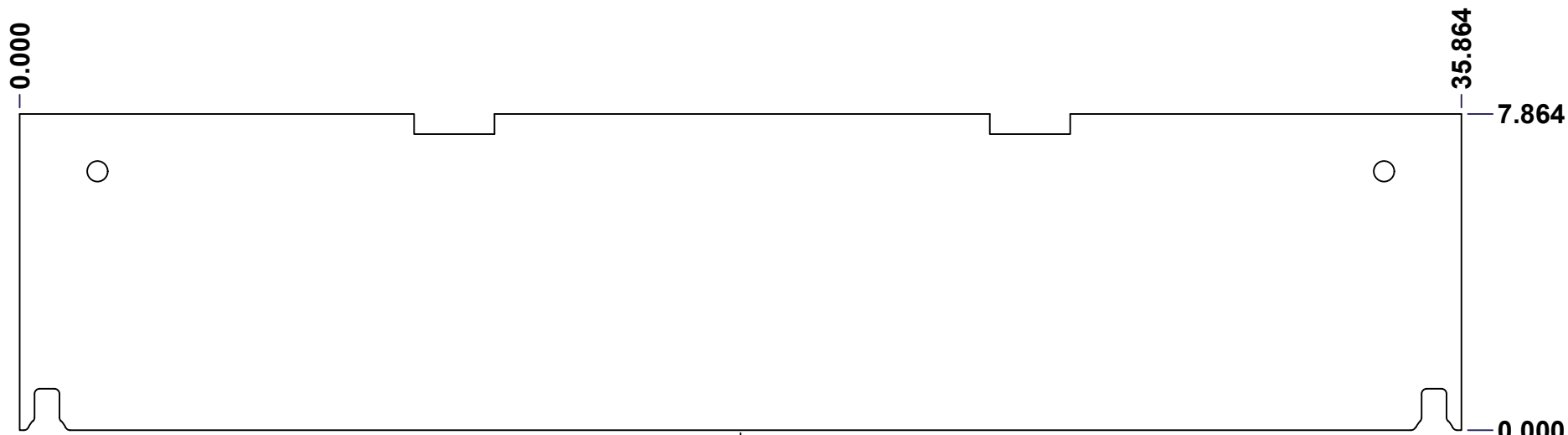

FRONT

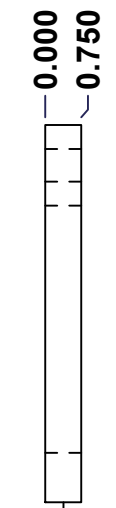

RIGHT

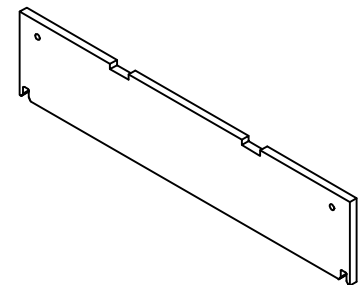

Isometric View

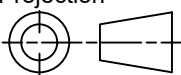

| No. | Revisions | Date | By/Par |
|-----|-----------|------|--------|
|     |           |      |        |
|     |           |      |        |
|     |           |      |        |
|     |           |      |        |
|     |           |      |        |

|  |                  |   |
|--|------------------|---|
|  Tél: (450) 979-4373<br>Fax: (450) 979-4626<br><a href="http://www.exmweb.com">www.exmweb.com</a> |                  | Flatness<br>Aplatissement<br>Max 3.0mm<br>Projection<br> |
| Customer Client  | Date             |   |
| Drawn By<br>Dessiné Par  | BoxCad: BoxCad   | Date 4/3/2024   |
| Material<br>Matière  | Polyisocyanurate |   |
| Color<br>Couleur   | Aluminum         | Finish<br>Fini Smooth   |
| Description  | Detail Rev.      |   |
| 5412ESDG 48" x 36"Bottom Insulation  |                  |   |
| Part Number<br>Numéro Pièce  | Rev. 0           | 15 / 16   |

SEE BILL OF MATERIAL ON LAST PAGE

**5412ESDG483608THI-BT**

This drawing is confidential and must not be reproduced or used without the consent of EXM

Ce dessin est confidentiel et ne doit pas être reproduit ou utilisé sans le consentement de EXM

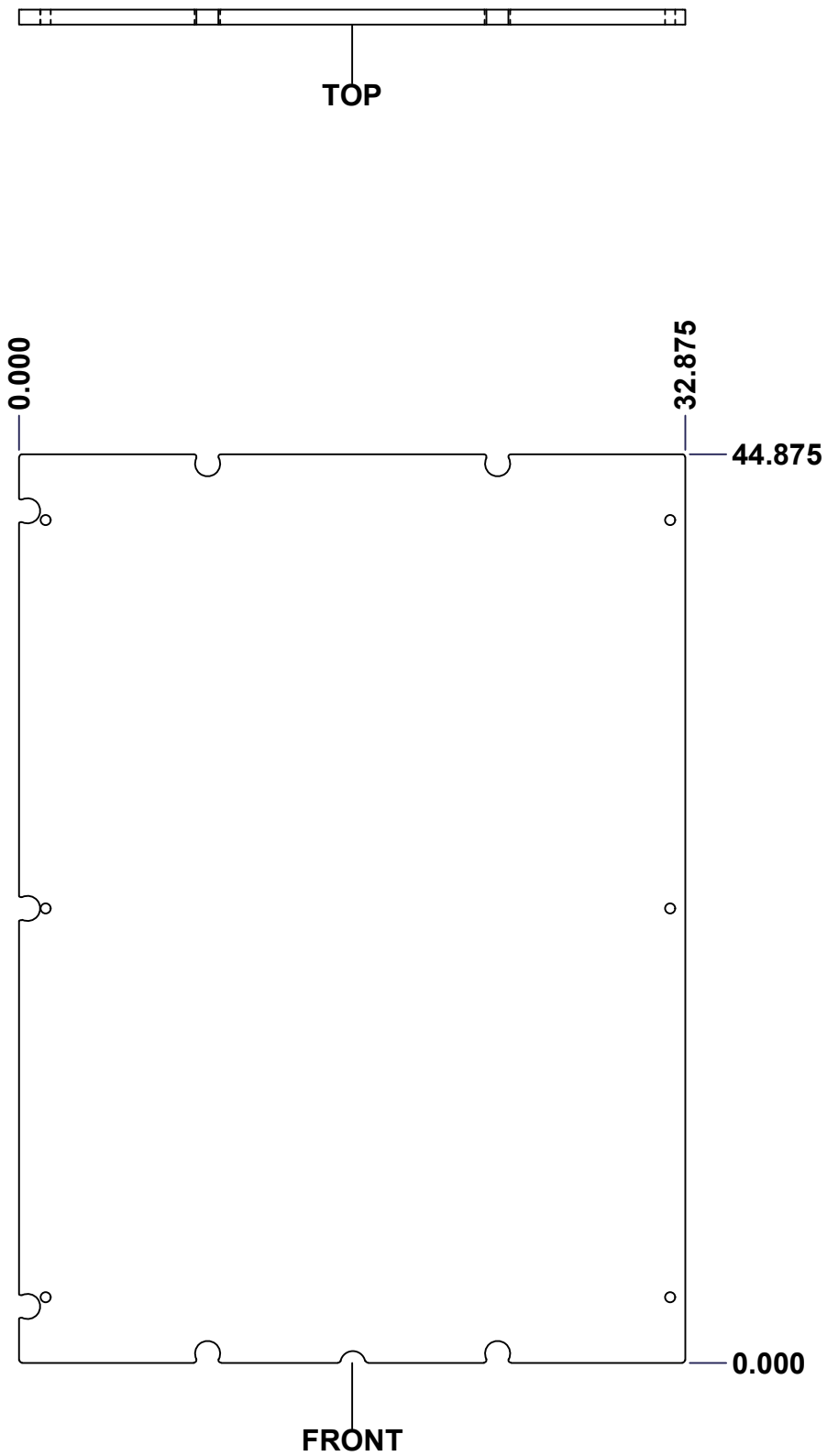

| No. | Revisions | Date | By/Par |
|-----|-----------|------|--------|
|     |           |      |        |
|     |           |      |        |
|     |           |      |        |
|     |           |      |        |
|     |           |      |        |

**Isometric View**

|  |          |                           |             |
|--|----------|---------------------------|-------------|
| Tél: (450) 979-4373<br>Fax: (450) 979-4626<br><a href="http://www.exmweb.com">www.exmweb.com</a> |          | Flatness<br>Aplatissement |             |
|  |          | Max 3.0mm                 |             |
| Customer<br>Client   |          | Date                      |             |
| Drawn By<br>Dessiné Par  |          | Date 23-Jan-07            |             |
| Material<br>Matière  |          | Polyisocyanurate          |             |
| Color<br>Couleur   | Aluminum | Finish<br>Fini            | N/A         |
| Description  |          |                           | Detail Rev. |
| 5412ESDG 48" x 36" Cover Insulation  |          |                           |             |
| Part Number<br>Numéro Pièce  |          | Rev.                      | 16          |
| 5412ESDG483608THI-C  |          | 0                         | 16          |

**SEE BILL OF MATERIAL ON LAST PAGE**

This drawing is confidential and must not be reproduced or used without the consent of EXM

Ce dessin est confidentiel et ne doit pas être reproduit ou utilisé sans le consentement de EXM

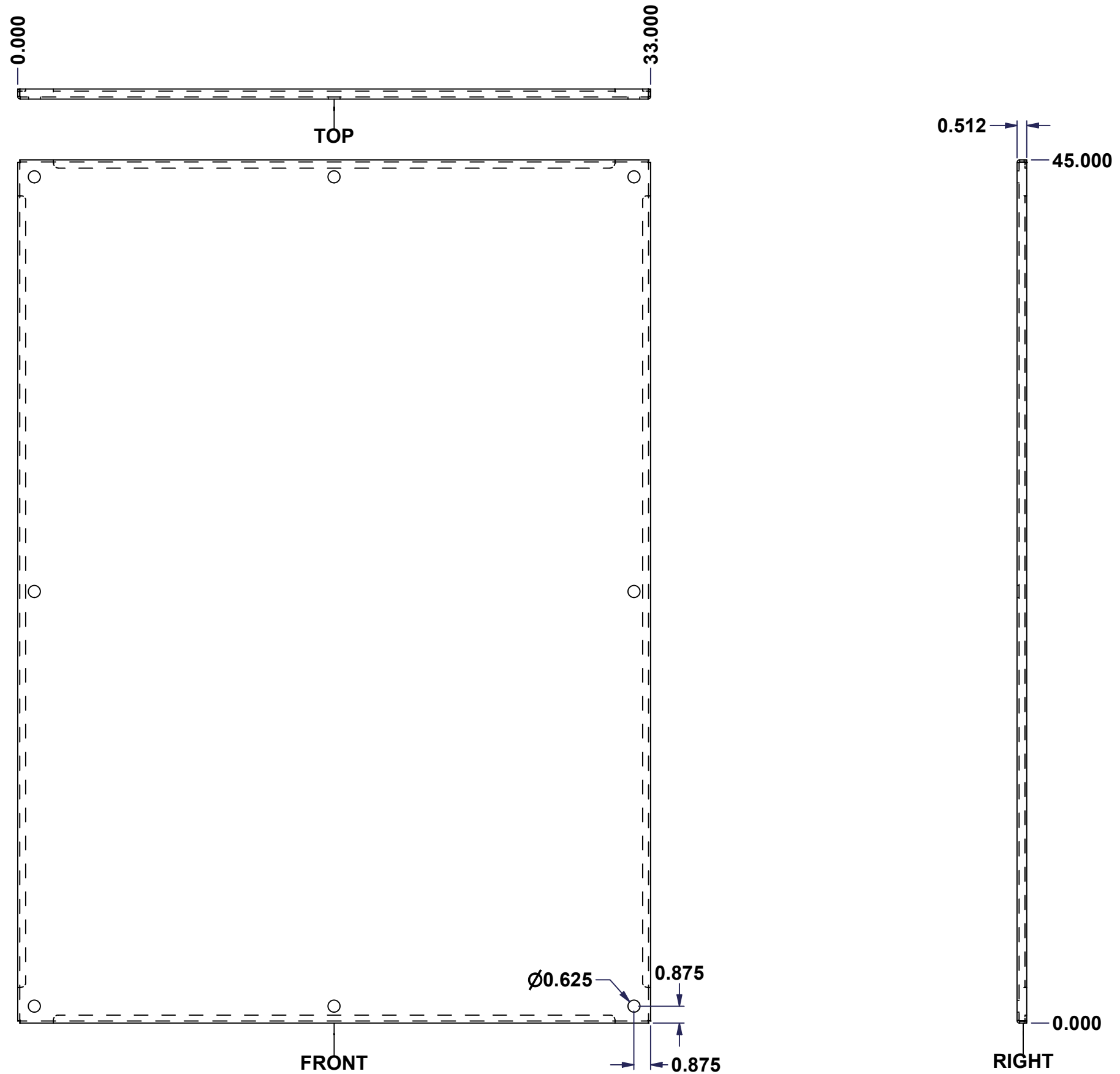

| No. | Revisions | Date | By/Par |
|-----|-----------|------|--------|
|     |           |      |        |
|     |           |      |        |
|     |           |      |        |
|     |           |      |        |
|     |           |      |        |

**Isometric View**

|  |                              |                           |
|--|------------------------------|---------------------------|
| Tél: (450) 979-4373<br>Fax: (450) 979-4626<br><a href="http://www.exmweb.com">www.exmweb.com</a> |                              | Flatness<br>Aplatissement |
|  |                              | Max 3.0mm                 |
| Projection   |                              |                           |
| Customer Client  |                              | Date                      |
| Drawn By / Dessiné Par: BoxCad: nickz  |                              | Date: 01/03/2017          |
| Material / Matière: 12 Ga Galvanized (2.5mm)   |                              |                           |
| Color / Couleur: See Part List   | Finish / Fini: See Part List |                           |
| Description: 885SP 48" x 36" Inner Panel Part  |                              | Detail Rev.               |
| Part Number / Numéro Pièce: <b>885SP4836G</b>  |                              | Rev. 1                    |

| Qty | Part Number  | Rev | Description                      | Material                 | Color     | Finish     |
|-----|--------------|-----|----------------------------------|--------------------------|-----------|------------|
| 1   | 885SP4836G-P | 0   | 885SP 48" x 36" Inner Panel Part | 12 Ga Galvanized (2.5mm) | Unpainted | Galvanized |

Parts List