

This drawing is confidential and must not be reproduced or used without the consent of EXM

Ce dessin est confidentiel et ne doit pas être reproduit ou utilisé sans le consentement de EXM

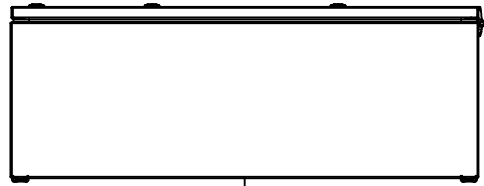

TOP

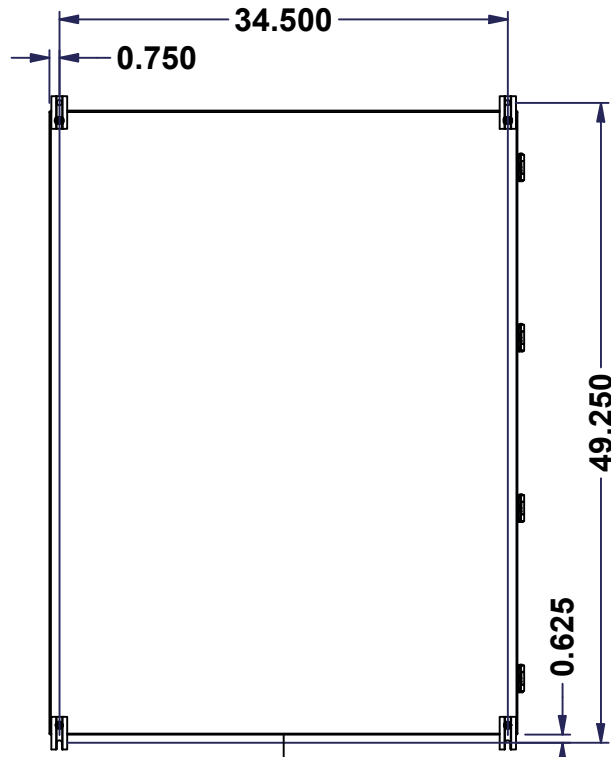

BACK

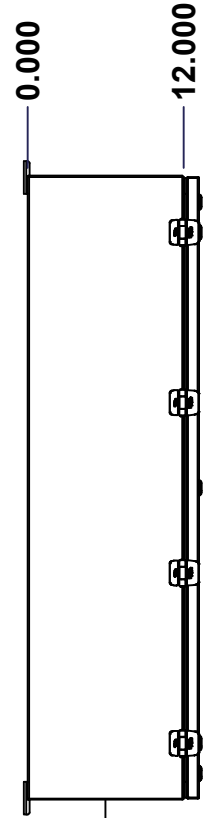

LEFT

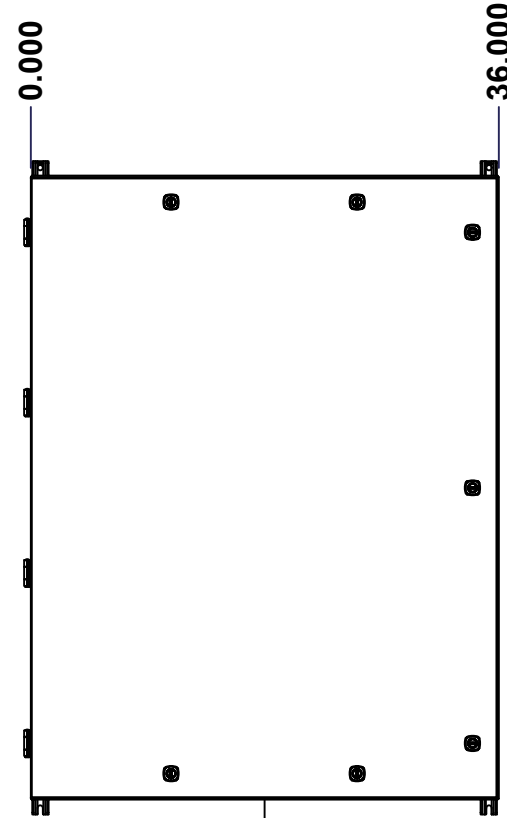

FRONT

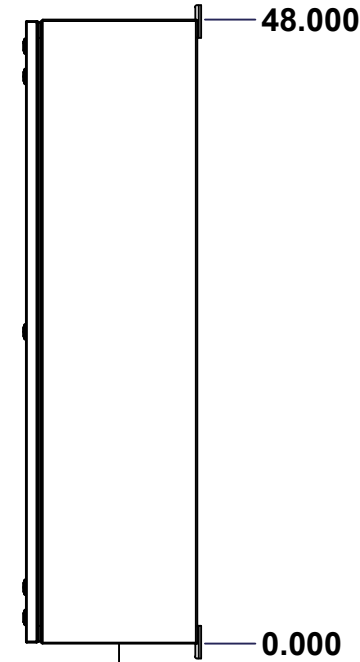

RIGHT

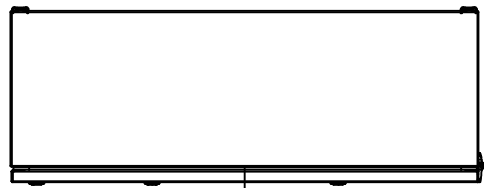

BOTTOM

No.	Revisions	Date	By/Par

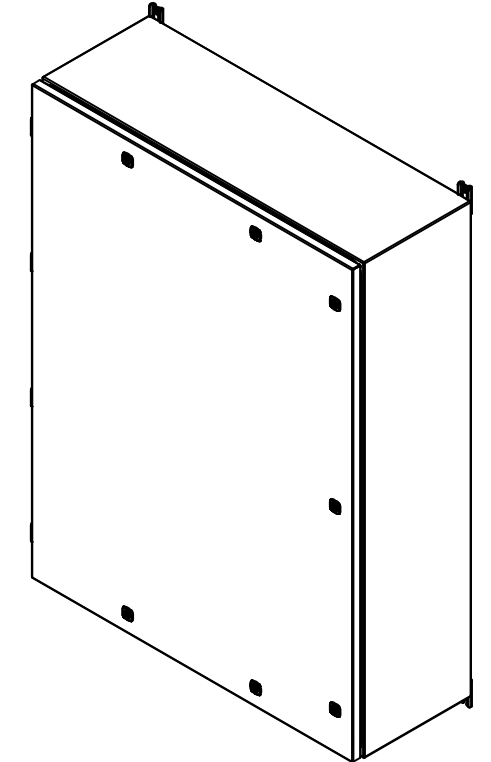

Isometric View



Tél: (450) 979-4373
 Fax: (450) 979-4626
www.exmweb.com

Flatness
Aplatissement

Max 3.0mm

Projection



Customer Client	Date
Drawn By / Dessiné Par: BoxCad: BoxCad	Date: 03-Jan-25
Material / Matière: 14 Ga Cold Rolled A1008 CS Type B (1.7mm)	
Color / Couleur: Asa-61 Grey	Finish / Fini: Smooth

Description: 5412ESDG 48" x 36" x 12" Assembly

Part Number / Numéro Pièce: 5412ESDG483612TH	Rev. 0	1
--	--------	---

SEE BILL OF MATERIAL ON LAST PAGE

This drawing is confidential and must not be reproduced or used without the consent of EXM

Ce dessin est confidentiel et ne doit pas être reproduit ou utilisé sans le consentement de EXM

NOTE	
ITEM	DESCRIPTION
1	NEMA 4, 12 Enclosure (IP66)
2	C/W Standard ground studs on box and cover
3	C/W Standard door stiffener
4	C/W Standard inner panel (Included)
5	C/W Standard inner panel mounting studs
6	C/W 885 ESMF3_OPEN Sold separately (Installed)
7	C/W 885 ESMF3_CLOSE Sold separately (Installed)
8	C/W R5 Insulation (Installed aluminum visible)

No.	Revisions	Date	By/Par

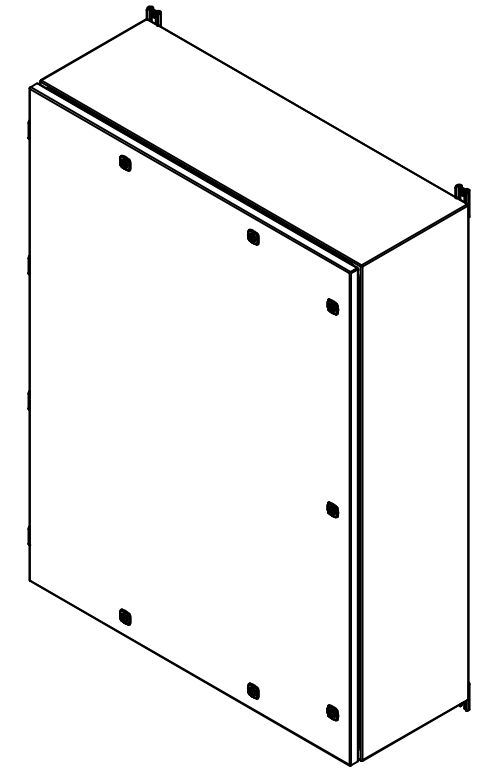

Isometric View



 Tél: (450) 979-4373
 Fax: (450) 979-4626
www.exmweb.com

Flatness
 Aplatissement
 Max 3.0mm
 Projection

Customer Client	Date
Drawn By Dessiné Par BoxCad: BoxCad	Date 03-Jan-25
Material Matière 14 Ga Cold Rolled A1008 CS Type B (1.7mm)	

Color Couleur Asa-61 Grey	Finish Fini Smooth
Description 5412ESDG 48" x 36" x 12" Assembly	
Part Number Numéro Pièce 5412ESDG483612TH	Rev. 0

PACKING		
ITEM	QTY	DESCRIPTION
Cardboard sleeve	2	Top and Bottom
Cardboard strip	2	Between back of enclosure and inner panel
Plastic bag	1	To protect cover surface and inside gasket
Cardboard corner	4	To reinforced for the plastic strap tightening
Plastic strap - Black	2	To Squeeze the 2 cardboard sleeve together
Packaging label	3	White label with PN
Plastic strap- Green	2	To secure the enclosure to the wood pallet
Wood Pallet	1	2" deeper and 3" larger than enclosure size

Qty	Part Number	Rev	Description
8	STK-Q-00600	2	M12 to M8 Adaptor
1	885SP4836G	0	885SP 48" x 36" Inner Panel Part
1	STK-K-01800	5	5412 ES Accessory Kit
4	STK-Q-10252	0	M6 Stainless Steel Sealing Washer
1	5412ESDG483612THC	0	5412ESDG 48" x 36" Cover
1	5412ESDG483612THB	0	5412ESDG 48" x 36" x 12" Body
4	STK-Q-07220	1	M6 Nylon Insert Lock Nut
Parts List			

This drawing is confidential and must not be reproduced or used without the consent of EXM

Ce dessin est confidentiel et ne doit pas être reproduit ou utilisé sans le consentement de EXM

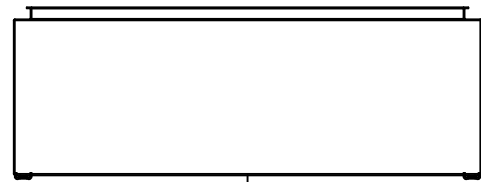

TOP

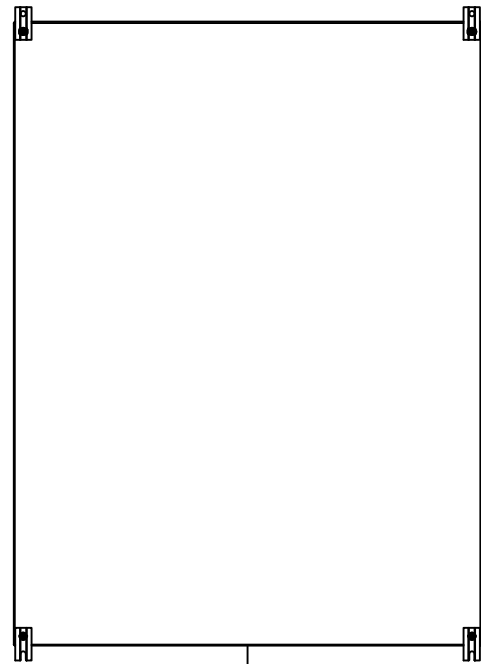

BACK

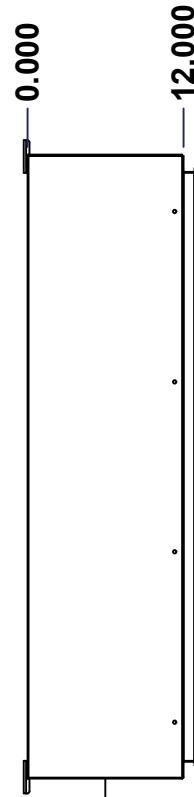

LEFT

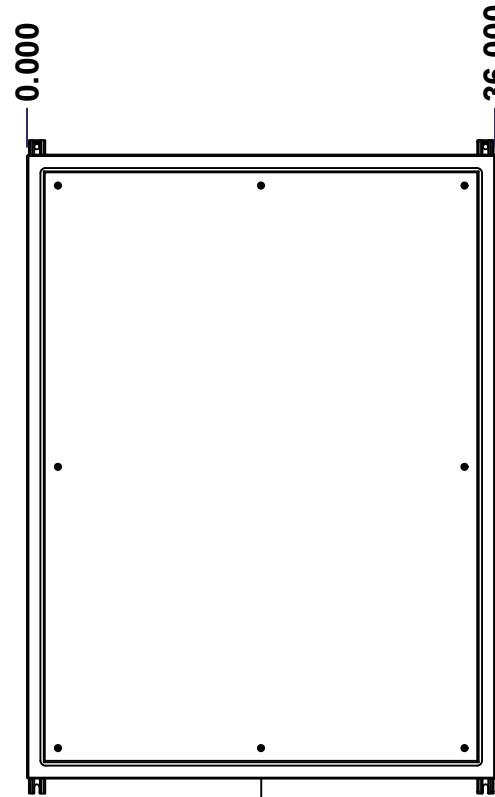

FRONT

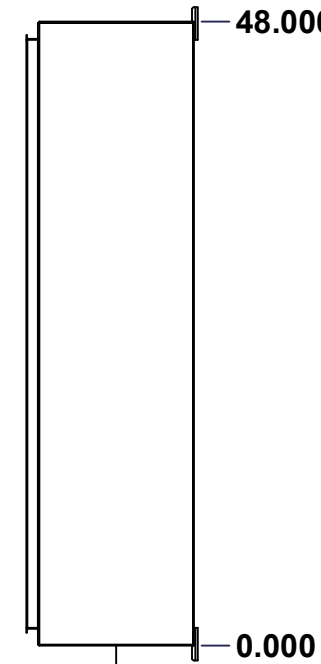

RIGHT

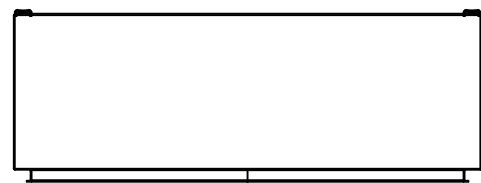

BOTTOM

No.	Revisions	Date	By/Par

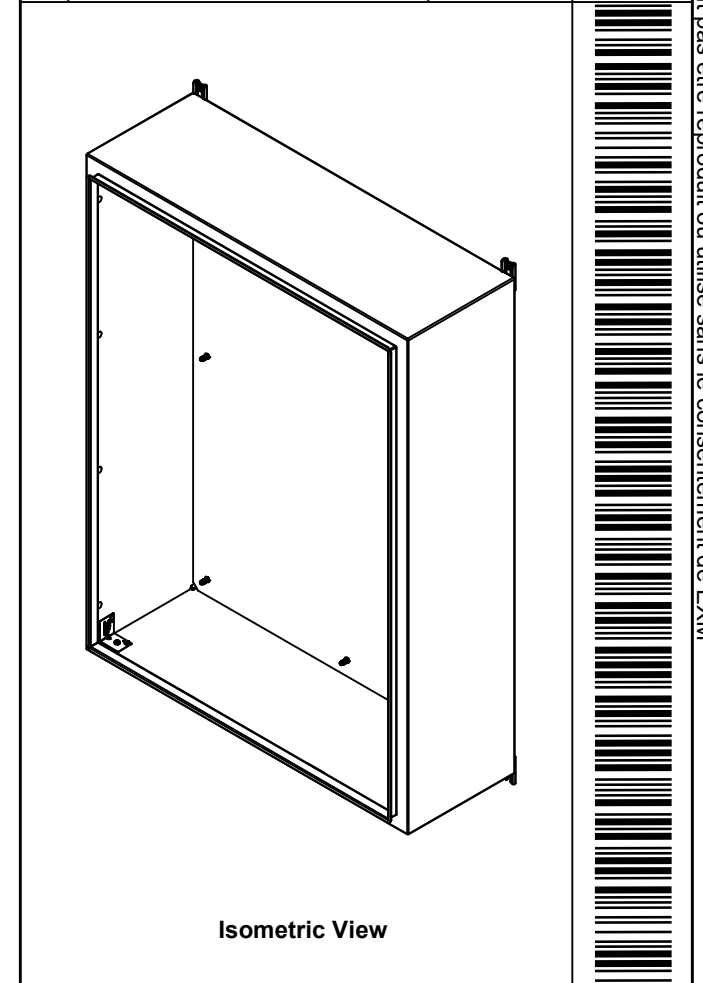

Isometric View

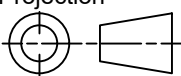
 Tél: (450) 979-4373 Fax: (450) 979-4626 www.exmweb.com		Flatness Aplatissement Max 3.0mm Projection 
Customer Client	Date	
Drawn By Dessiné Par	BoxCad: BoxCad	Date 03-Jan-25
Material Matière	14 Ga Cold Rolled A1008 CS Type B (1.7mm)	
Color Couleur	Asa-61 Grey	Finish Fini Smooth
Description	Detail Rev.	
5412ESDG 48" x 36" x 12" Body		
Part Number Numéro Pièce	Rev. 0	3 / 16

SEE BILL OF MATERIAL ON LAST PAGE

5412ESDG483612THB

This drawing is confidential and must not be reproduced or used without the consent of EXM

Ce dessin est confidentiel et ne doit pas être reproduit ou utilisé sans le consentement de EXM

STANDARD FEATURES ARE NOT LISTED IN THIS HOLE TABLE			
HOLE TABLE - TOP VIEW (CUSTOM FEATURE ONLY)			
CUT-OUT	XDIM	YDIM	DESCRIPTION
1	2.000	10.500	INSUL. STUD M6 x 18mm (Inside)
2	34.000	10.500	INSUL. STUD M6 x 18mm (Inside)

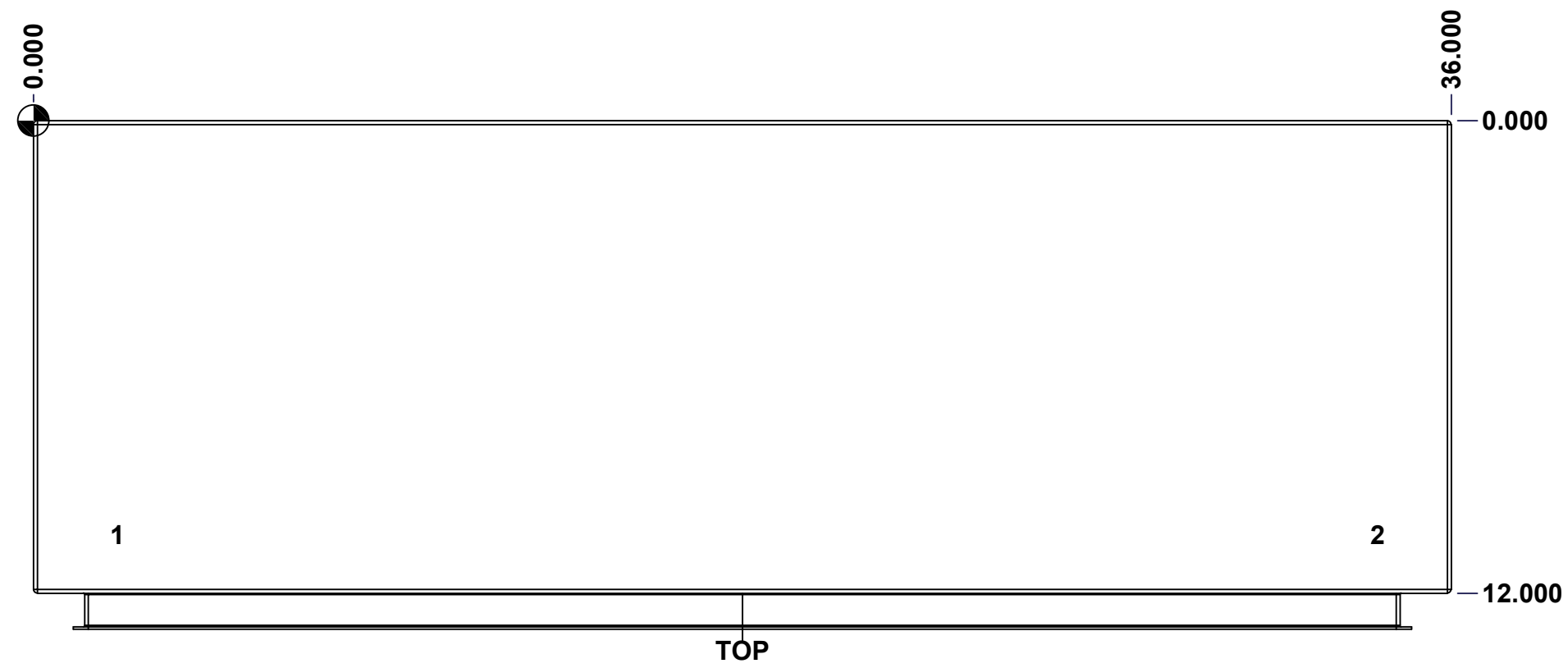

	Description	Status
	5412ESDG 48" x 36" x 12" Body	(NULL)
	Part Number Numéro Pièce	Rev.
	5412ESDG483612THB	0 / 4
		16

This drawing is confidential and must not be reproduced or used without the consent of EXM

Ce dessin est confidentiel et ne doit pas être reproduit ou utilisé sans le consentement de EXM

STANDARD FEATURES ARE NOT LISTED IN THIS HOLE TABLE			
HOLE TABLE - BOTTOM VIEW (CUSTOM FEATURE ONLY)			
CUT-OUT	XDIM	YDIM	DESCRIPTION
1	2.000	10.500	INSUL. STUD M6 x 18mm (Inside)
2	34.000	10.500	INSUL. STUD M6 x 18mm (Inside)

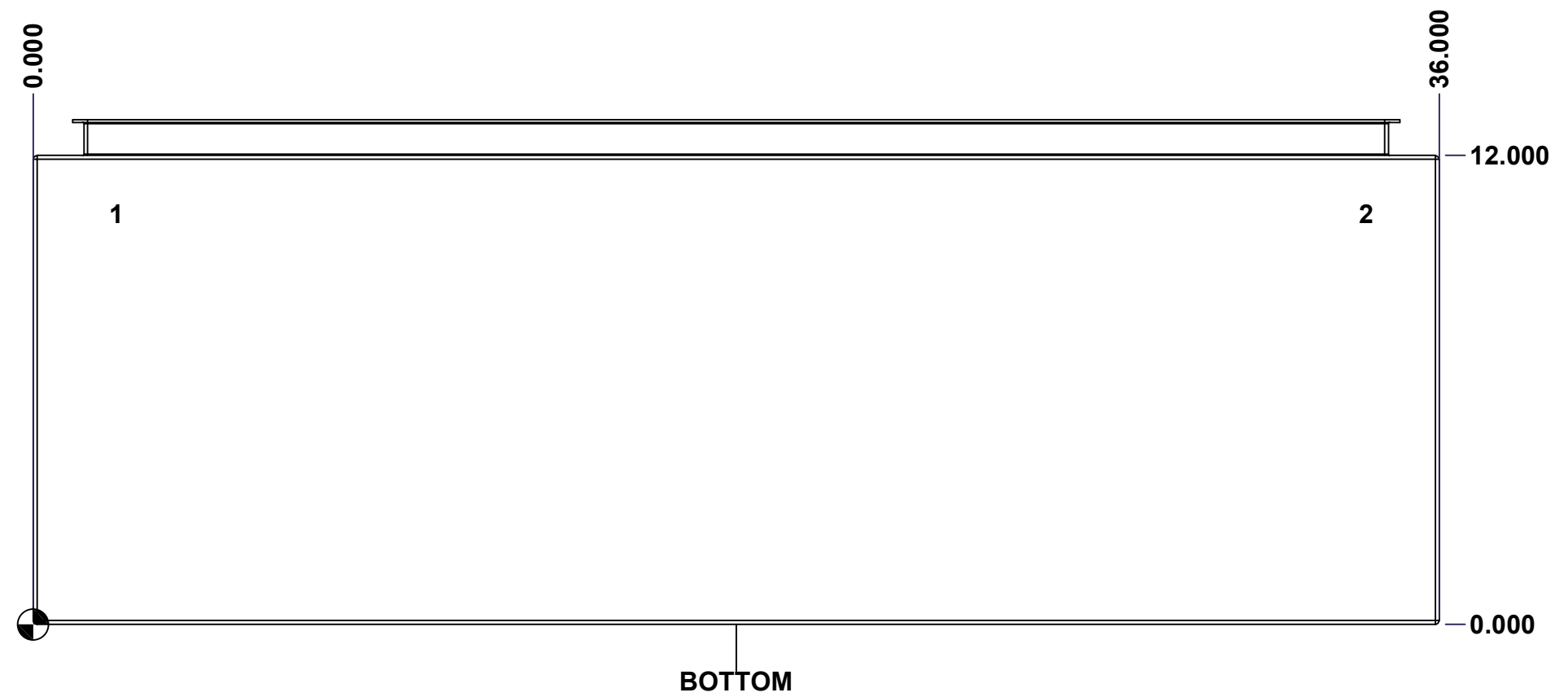

	Description	Status
	5412ESDG 48" x 36" x 12" Body	(NULL)
	Part Number Numéro Pièce	Rev.
	5412ESDG483612THB	0
		5
		16

This drawing is confidential and must not be reproduced or used without the consent of EXM

Ce dessin est confidentiel et ne doit pas être reproduit ou utilisé sans le consentement de EXM

STANDARD FEATURES ARE NOT LISTED IN THIS HOLE TABLE

HOLE TABLE - BACK VIEW (CUSTOM FEATURE ONLY)

CUT-OUT	XDIM	YDIM	DESCRIPTION
1	2.375	2.375	IP STUD M8 x 35mm (Inside)
2	2.375	45.625	IP STUD M8 x 35mm (Inside)
3	33.625	45.625	IP STUD M8 x 35mm (Inside)
4	33.625	2.375	IP STUD M8 x 35mm (Inside)
5	2.375	24.000	IP STUD M8 x 35mm (Inside)
6	33.625	24.000	IP STUD M8 x 35mm (Inside)
7	18.000	2.375	IP STUD M8 x 35mm (Inside)
8	18.000	45.625	IP STUD M8 x 35mm (Inside)

9	35.250	0.000	FOOT 885 ESMF3_OPEN
10	0.750	0.000	FOOT 885 ESMF3_OPEN
11	35.250	48.000	FOOT 885 ESMF3_CLOSE
12	0.750	48.000	FOOT 885 ESMF3_CLOSE

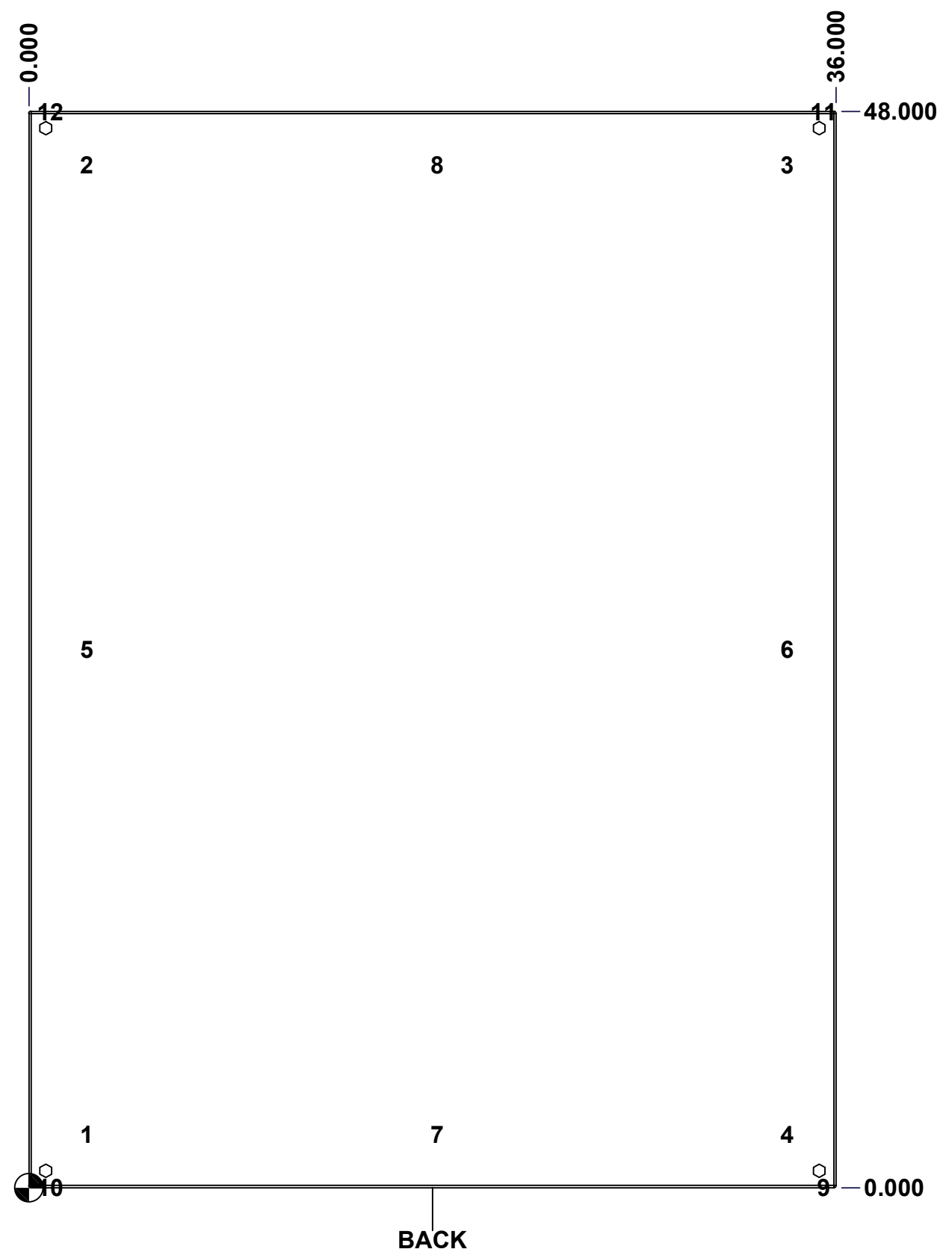

	Description	Status
	5412ESDG 48" x 36" x 12" Body	(NULL)
Part Number Numéro Pièce 5412ESDG483612THB	Rev.	6
	0	16

This drawing is confidential and must not be reproduced or used without the consent of EXM

Ce dessin est confidentiel et ne doit pas être reproduit ou utilisé sans le consentement de EXM

No.	Revisions	Date	By/Par

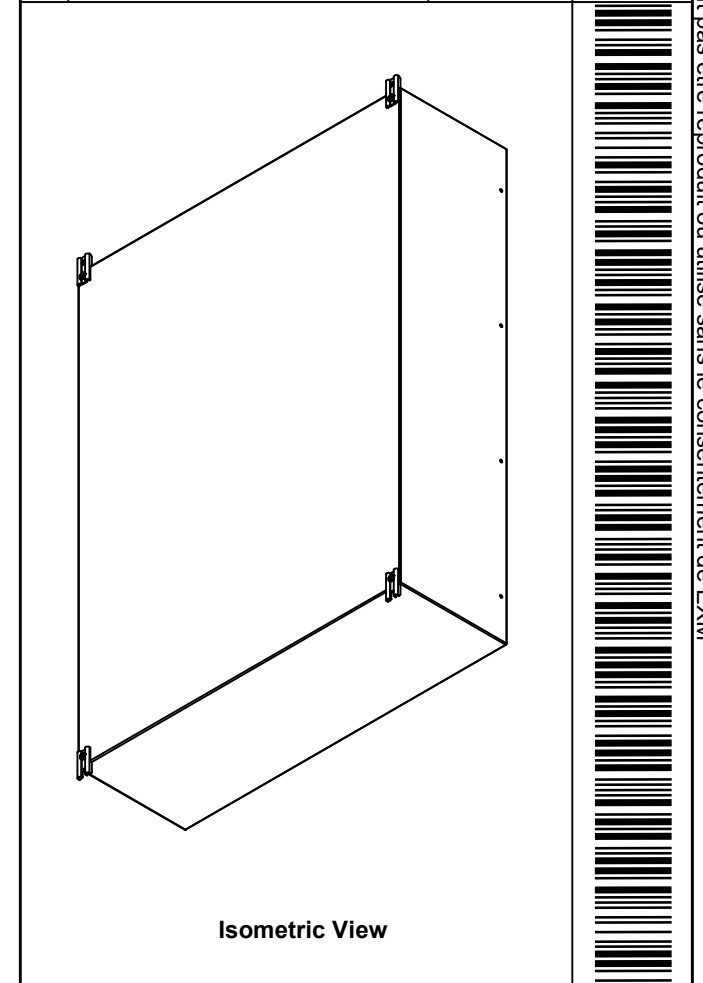

1	885 ESMF3	0	885 ESMF3 Mounting Foot Kit
4	RIVET_NUT_M10_FH_CE	0	Rivet Nut M10 (Low Profile Close End)
1	STK-K-70554	3	5412 ESTH Accessory Kit
1	5412ESDG483612THI-RS	0	5412ESDG 48" x 36" Right Insulation
1	5412ESDG483612THI-LS	0	5412ESDG 48" x 36" Left Insulation
1	5412ESDG483612THI-BT	0	5412ESDG 48" x 36" Bottom Insulation
1	5412ESDG483612THI-TP	0	5412ESDG 48" x 36" Top Insulation
1	5412ESDG483612THI-B	0	5412ESDG 48" x 36" Back Insulation
4	STK-Q-16055	1	M6 x 18mm Stud (No Paint Cap Required)
1	STK-P-02400S	0	Powder Paint (Asa-61 Grey / Smooth)
8	STK-Q-16005	0	Stud M8 x 35mm Steel
1	5412ESDG483612THB-P	0	5412ESDG 48" x 36" x 12" Body Part
Qty	Part Number	Rev	Description
Parts List			

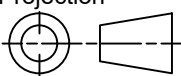
 Tél: (450) 979-4373 Fax: (450) 979-4626 www.exmweb.com		Flatness Aplatissement Max 3.0mm
Projection 		Customer Client
Drawn By Dessiné Par BoxCad: BoxCad		Date 03-Jan-25
Material Matière 14 Ga Cold Rolled A1008 CS Type B (1.7mm)		
Color Couleur Asa-61 Grey	Finish Fini Smooth	
Description 5412ESDG 48" x 36" x 12" Body		Detail Rev.
Part Number Numéro Pièce 5412ESDG483612THB		Rev. 7 0
		16

This drawing is confidential and must not be reproduced or used without the consent of EXM

Ce dessin est confidentiel et ne doit pas être reproduit ou utilisé sans le consentement de EXM

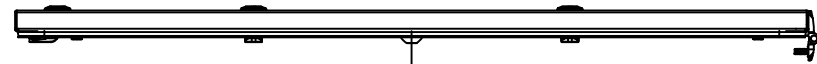

TOP

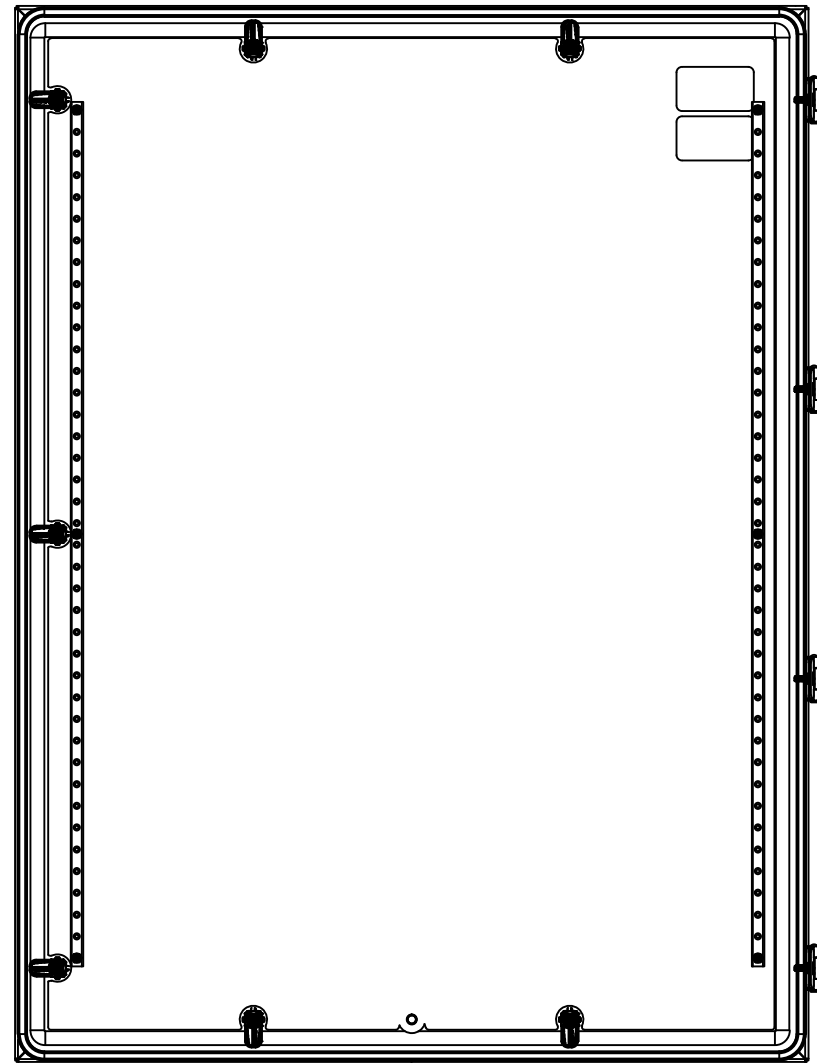

BACK



BOTTOM

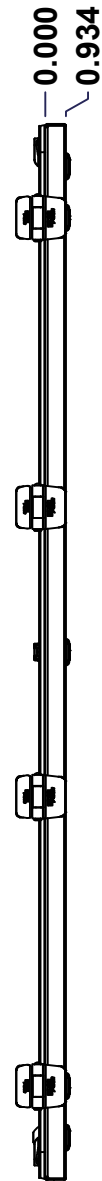

LEFT

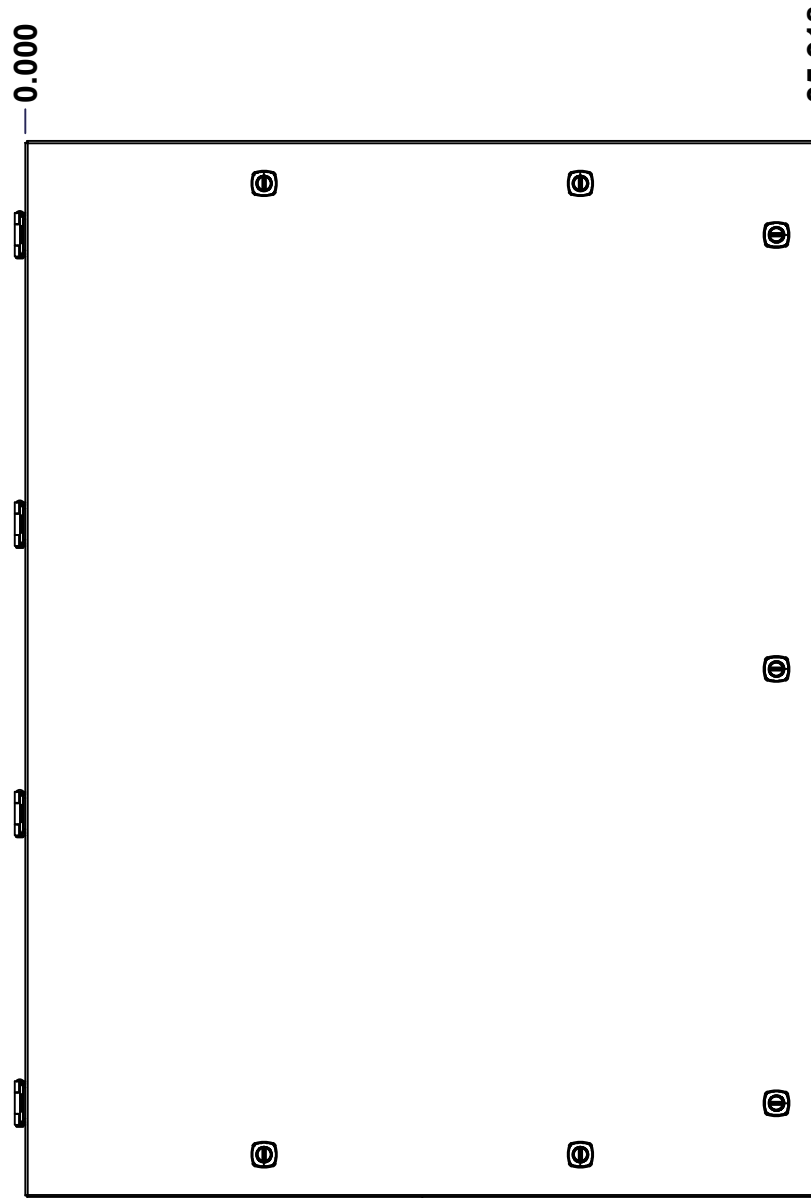

FRONT

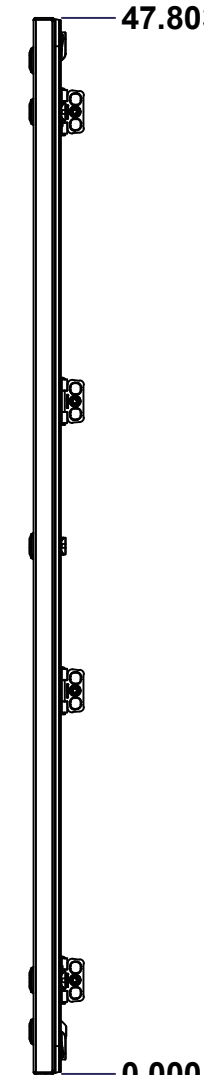

RIGHT

No.	Revisions	Date	By/Par

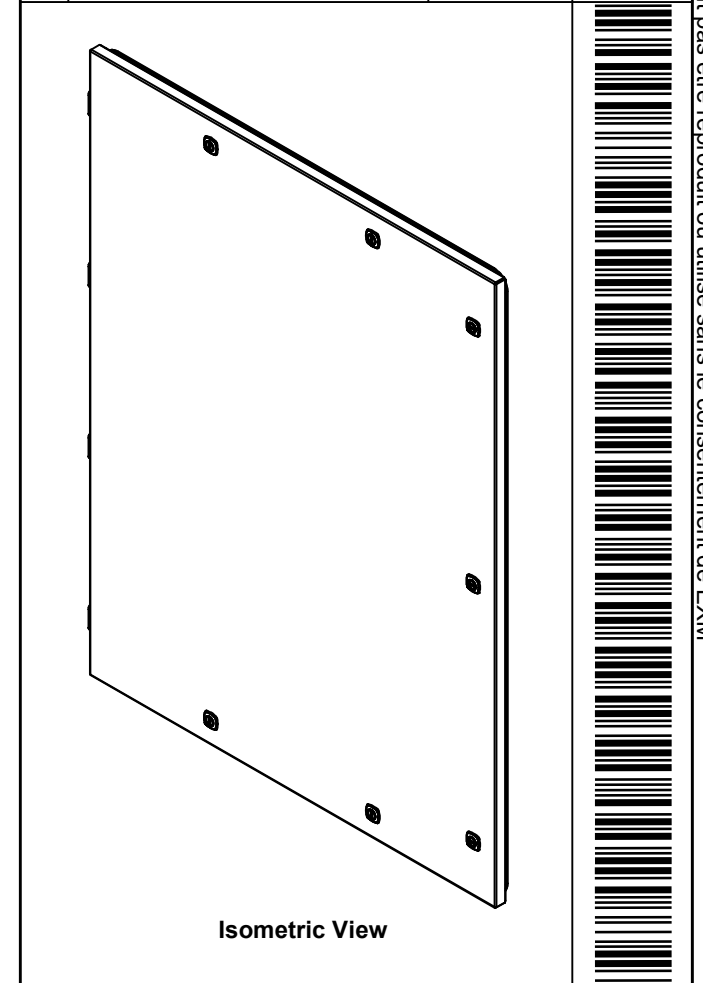

Isometric View

 Tél: (450) 979-4373 Fax: (450) 979-4626 www.exmweb.com		Flatness Aplatissement
		Max 3.0mm
Customer Client		Date
Drawn By / Dessiné Par: BoxCad: BoxCad		Date: 03-Jan-25
Material / Matière: 14 Ga Cold Rolled A1008 CS Type B (1.7mm)		
Color / Couleur: Asa-61 Grey	Finish / Fini: Smooth	
Description: 5412ESDG 48" x 36" Cover		Detail Rev.
Part Number / Numéro Pièce: 5412ESDG483612THC		Rev. 8
SEE BILL OF MATERIAL ON LAST PAGE		0 / 16

This drawing is confidential and must not be reproduced or used without the consent of EXM

Ce dessin est confidentiel et ne doit pas être reproduit ou utilisé sans le consentement de EXM

STANDARD FEATURES ARE NOT LISTED IN THIS HOLE TABLE

HOLE TABLE - FRONT VIEW (CUSTOM FEATURE ONLY)

CUT-OUT	XDIM	YDIM	DESCRIPTION
1	2.286	4.709	STUD M6 x 18mm (Inside)
2	2.286	43.094	STUD M6 x 18mm (Inside)
3	33.117	43.094	STUD M6 x 18mm (Inside)
4	33.117	4.709	STUD M6 x 18mm (Inside)
5	2.286	23.902	STUD M6 x 18mm (Inside)
6	33.117	23.902	STUD M6 x 18mm (Inside)
7	17.959	1.935	STUD M6 x 18mm (Inside)

8	33.994	43.553	LOCK 880 SCQ4-SL @ 0.0°
9	33.994	23.902	LOCK 880 SCQ4-SL @ 0.0°
10	33.994	4.250	LOCK 880 SCQ4-SL @ 0.0°
11	10.800	45.879	LOCK 880 SCQ4-SL @ 90.0°
12	25.118	45.879	LOCK 880 SCQ4-SL @ 90.0°
13	10.800	1.924	LOCK 880 SCQ4-SL @ 270.0°
14	25.118	1.924	LOCK 880 SCQ4-SL @ 270.0°

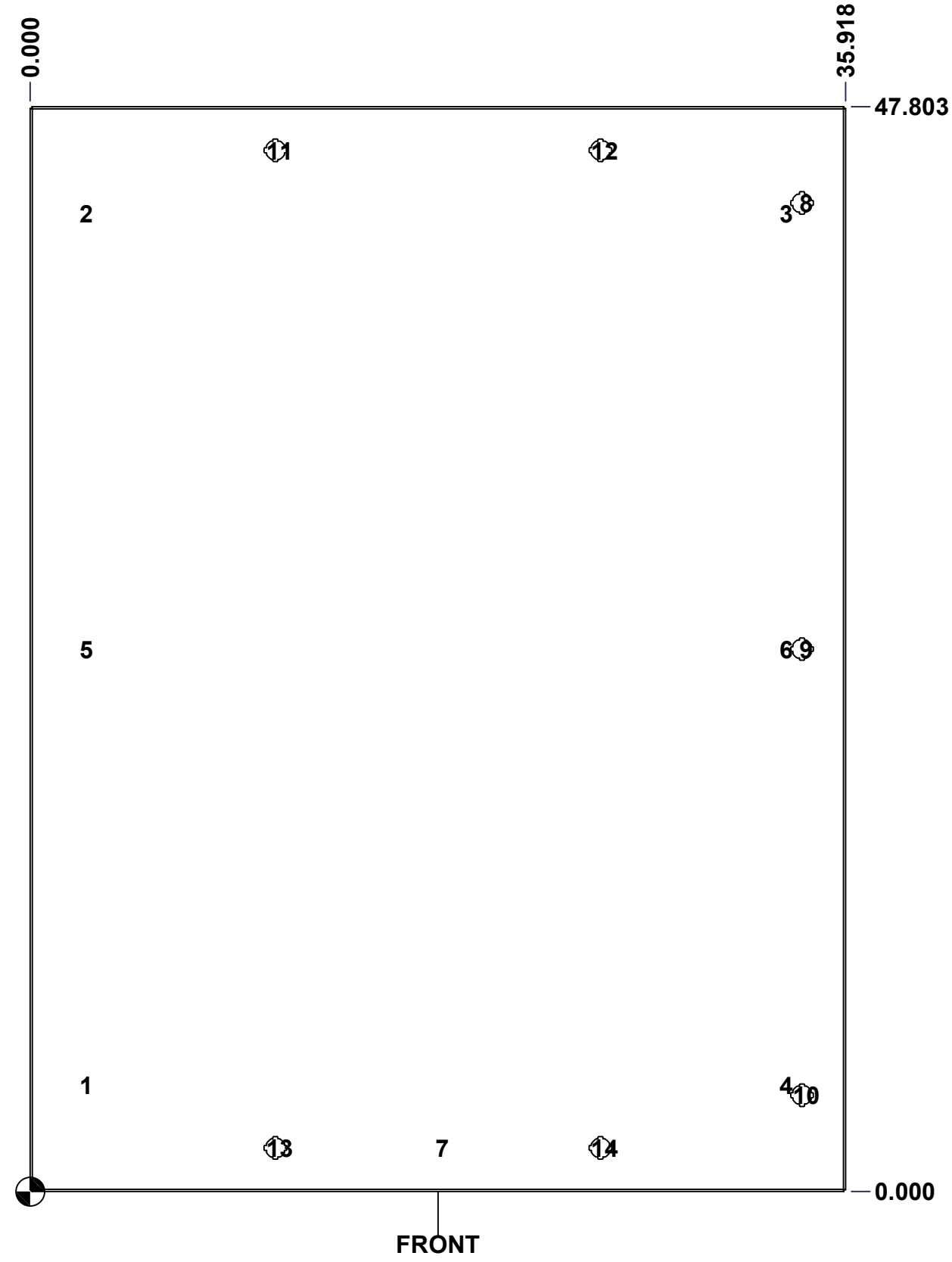

	Description	Status
	5412ESDG 48" x 36" Cover	(NULL)
Part Number Numéro Pièce 5412ESDG483612THC	Rev.	9
	0	16

This drawing is confidential and must not be reproduced or used without the consent of EXM

Ce dessin est confidentiel et ne doit pas être reproduit ou utilisé sans le consentement de EXM

No.	Revisions	Date	By/Par

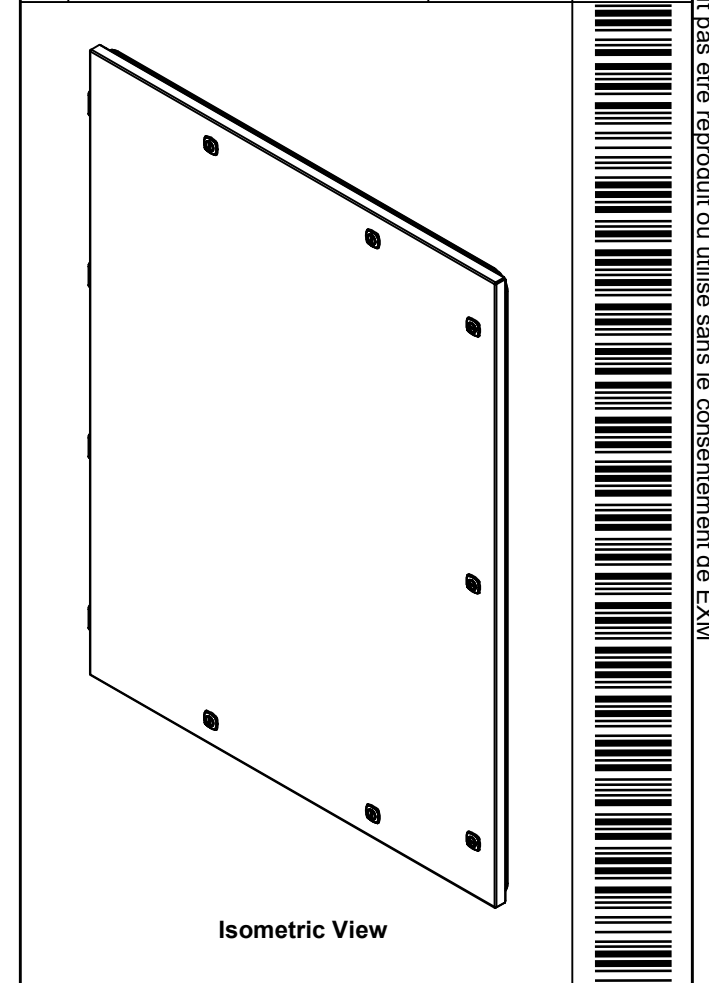

7	STK-K-12500	19	5412 ES 1/4 Turn Lock
2	STK-S-00100	0	3.5" x 2" Silver Milar Flexcon Sticker
6	STK-Q-07250	2	M6 x 16mm Collar Nut
2	STK-Q-46020-42	6	5412 ES Vertical Door Stiffener 42"
1	5412ESDG483612THI-C	0	5412ESDG 48" x 36" Cover Insulation
1	STK-P-02400S	0	Powder Paint (Asa-61 Grey / Smooth)
1	STK-Q-46515	3	5412 ES Door Support with Brass Insert
7	STK-Q-16055	1	M6 x 18mm Stud (No Paint Cap Required)
1	5412ESDG483612THG2	0	5412ESDG 48" x 36" Cover Gasket
1	5412ESDG483612THG	0	5412ESDG 48" x 36" Cover Gasket
1	5412ESDG483612THC-P	0	5412ESDG 48" x 36" Cover Part
4	STK-A-02360	0	External Hinge for Double Gasket
4	STK-Q-07220	1	M6 Nylon Insert Lock Nut
4	STK-Q-10252	0	M6 Stainless Steel Sealing Washer

QTY	Part Number	Rev	Description
Parts List			

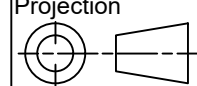
 Tél: (450) 979-4373 Fax: (450) 979-4626 www.exmweb.com	Flatness Aplatissement	Max 3.0mm
	Projection	
Customer Client	Date	
Drawn By Dessiné Par	BoxCad: BoxCad	Date 03-Jan-25
Material Matière	14 Ga Cold Rolled A1008 CS Type B (1.7mm)	
Color Couleur	Asa-61 Grey	Finish Fini Smooth
Description	Detail Rev.	
5412ESDG 48" x 36" Cover		
Part Number Numéro Pièce	Rev. 0	10 / 16
5412ESDG483612THC		

This drawing is confidential and must not be reproduced or used without the consent of EXM

Ce dessin est confidentiel et ne doit pas être reproduit ou utilisé sans le consentement de EXM

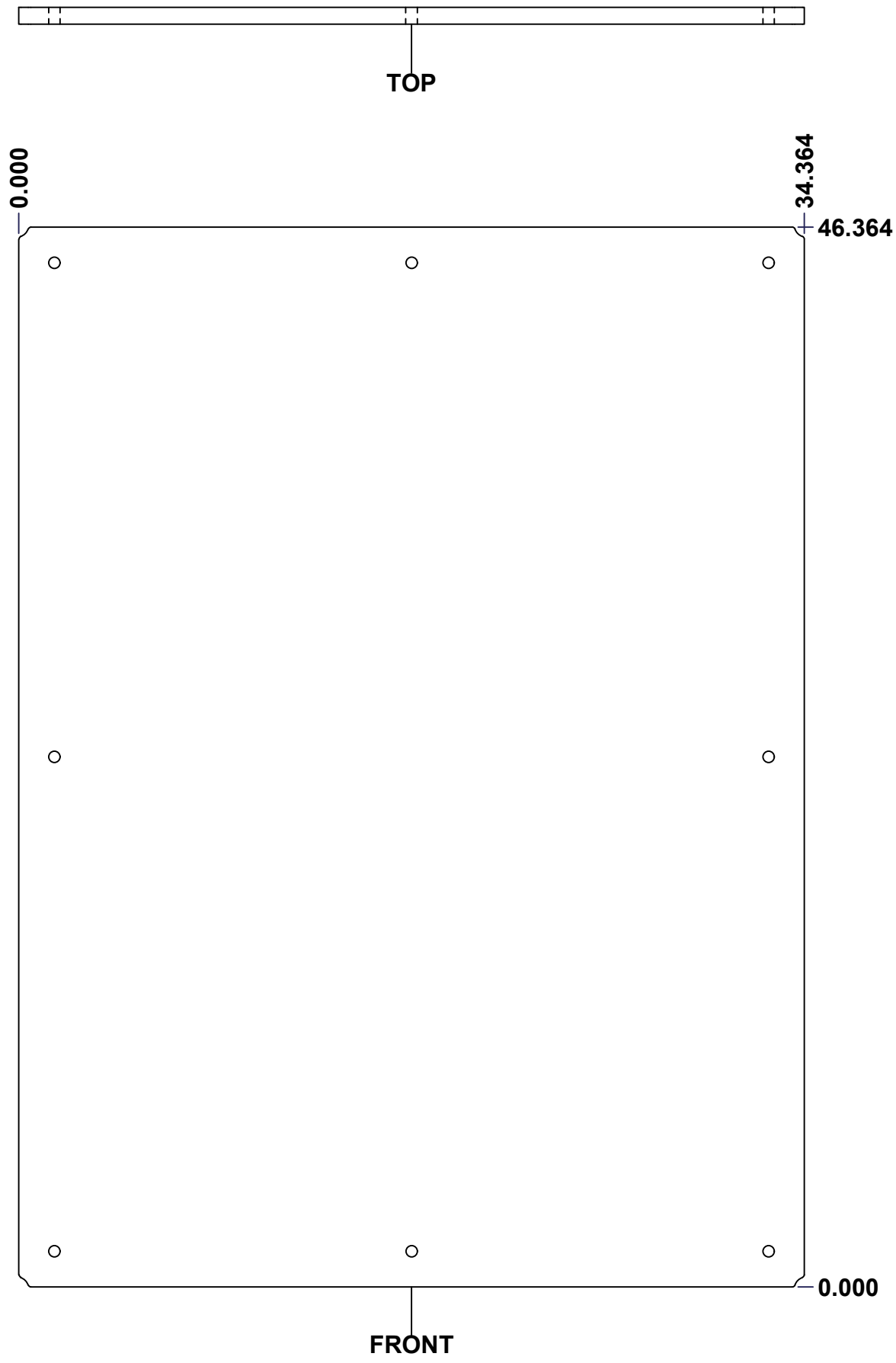

No.	Revisions	Date	By/Par

Isometric View

Tél: (450) 979-4373 Fax: (450) 979-4626 www.exmweb.com		Flatness Aplatissement	
		Max 3.0mm	
Projection		Date	
Customer Client	BoxCad: Patrick Deschenes	Date	23-Jan-07
Drawn By Dessiné Par	Material Matière		Polyisocyanurate
Color Couleur	Aluminum	Finish Fini	N/A
Description		Detail Rev.	
5412ESDG 48" x 36" Back Insulation			
Part Number Numéro Pièce	Rev.	11	16
5412ESDG483612THI-B	0		

SEE BILL OF MATERIAL ON LAST PAGE

This drawing is confidential and must not be reproduced or used without the consent of EXM

Ce dessin est confidentiel et ne doit pas être reproduit ou utilisé sans le consentement de EXM

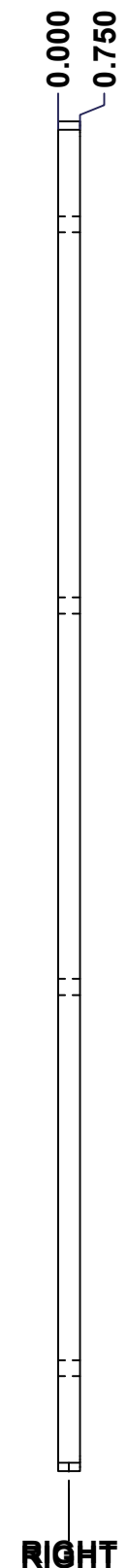
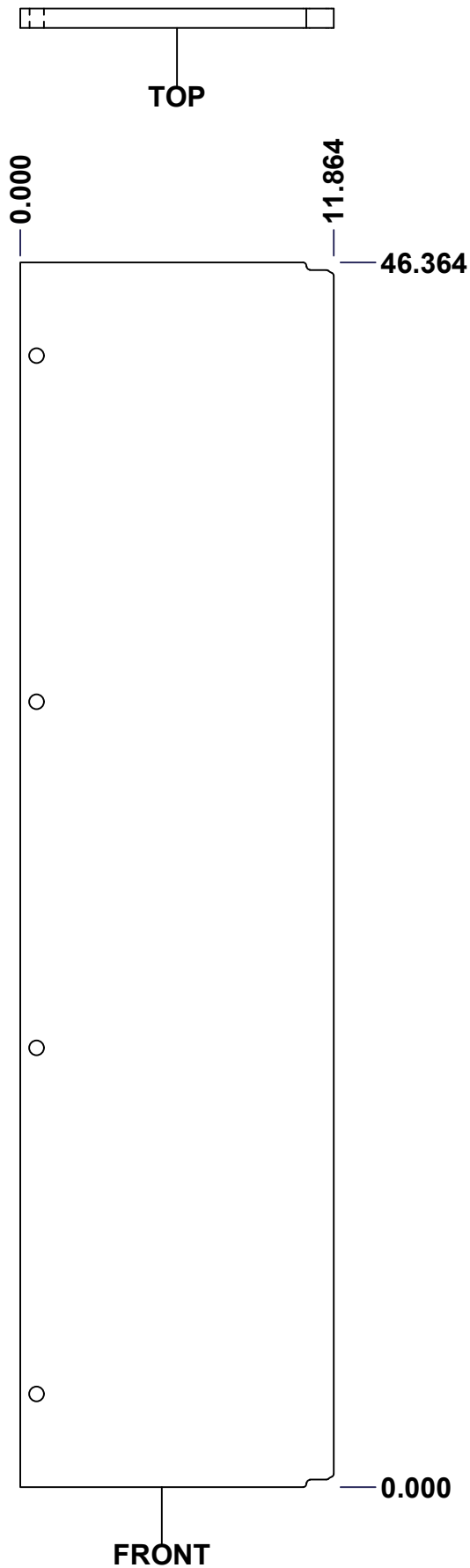

No.	Revisions	Date	By/Par

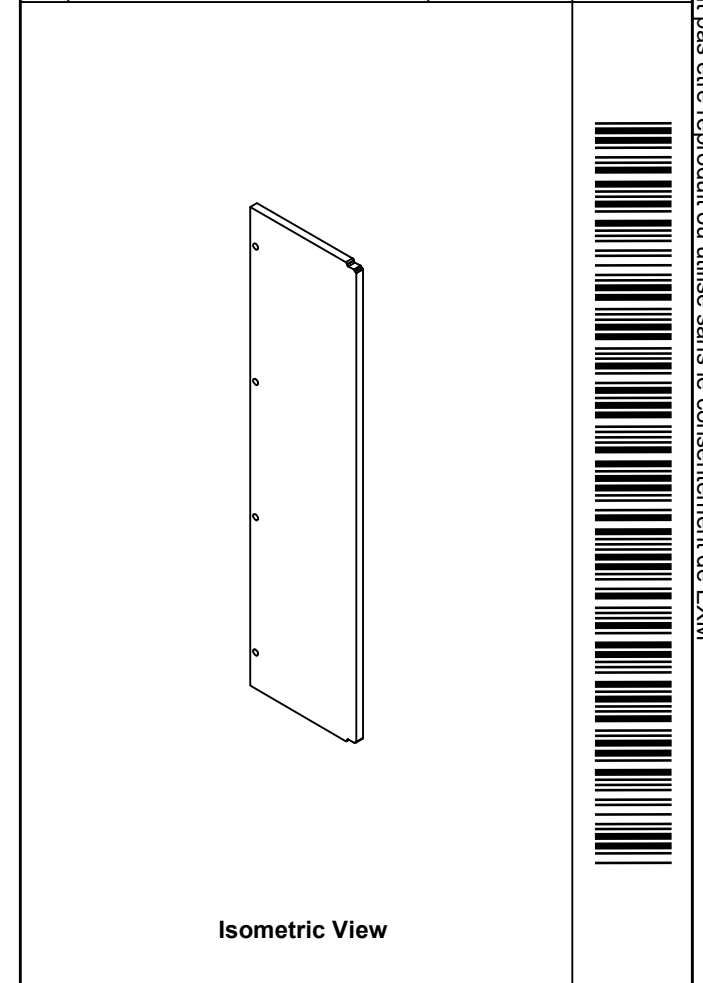

 Tél: (450) 979-4373 Fax: (450) 979-4626 www.exmweb.com		Flatness Aplatissement	
		Max 3.0mm	
Customer Client		Date	
Drawn By Dessiné Par		Date 23-Jan-07	
Material Matière		Polyisocyanurate	
Color Couleur	Aluminum	Finish Fini	N/A
Description			Detail Rev.
5412ESDG 48" x 36" Left Insulation			
Part Number Numéro Pièce		Rev.	12
5412ESDG483612THI-LS		0	16

SEE BILL OF MATERIAL ON LAST PAGE

This drawing is confidential and must not be reproduced or used without the consent of EXM

Ce dessin est confidentiel et ne doit pas être reproduit ou utilisé sans le consentement de EXM

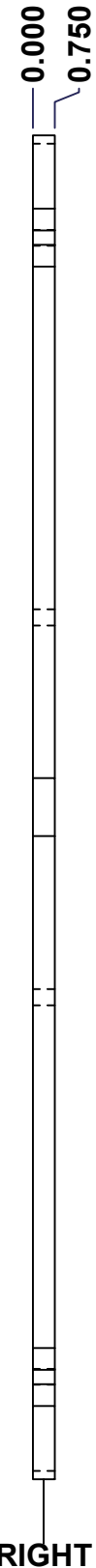
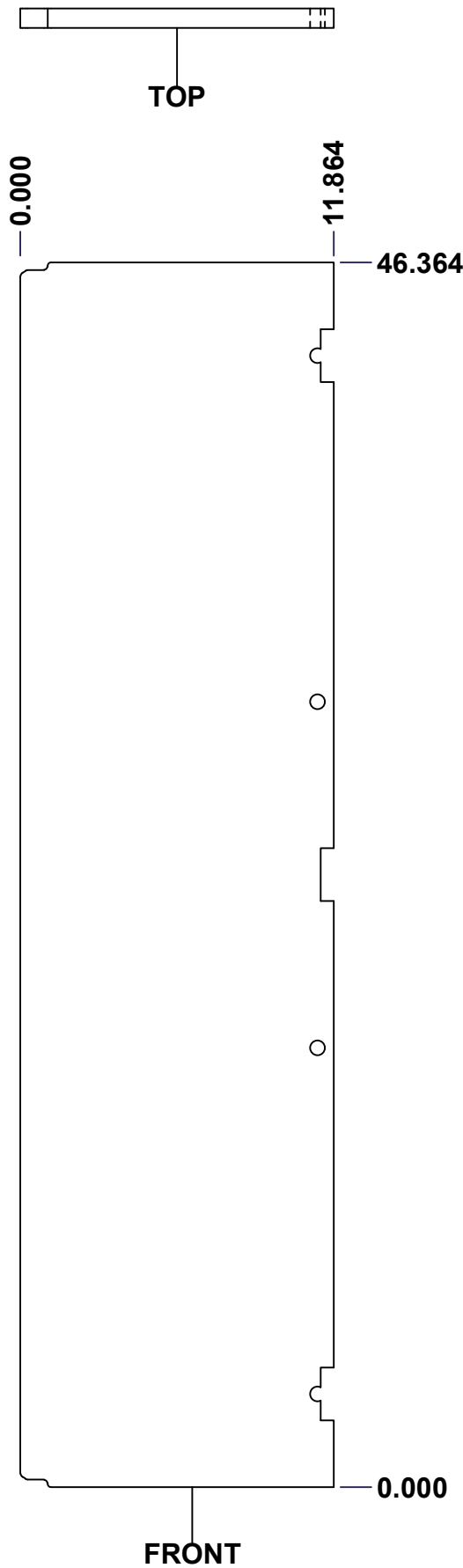

No.	Revisions	Date	By/Par

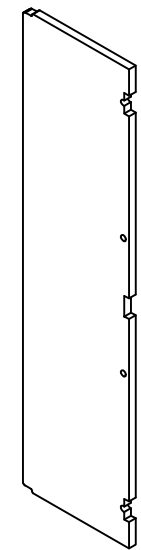

Isometric View



Tél: (450) 979-4373
 Fax: (450) 979-4626
www.exmweb.com

Flatness
 Aplatissement
 Max 3.0mm
 Projection

Customer Client	Date
Drawn By / Dessiné Par: BoxCad: Patrick Deschenes	Date: 23-Jan-07
Material / Matière: Polyisocyanurate	
Color / Couleur: Aluminum	Finish / Fini: N/A

Description: 5412ESDG 48" x 36" Right Insulation
 Detail Rev.

Part Number / Numéro Pièce: 5412ESDG483612THI-RS	Rev. 0	13 / 16
--	--------	---------

SEE BILL OF MATERIAL ON LAST PAGE

This drawing is confidential and must not be reproduced or used without the consent of EXM

Ce dessin est confidentiel et ne doit pas être reproduit ou utilisé sans le consentement de EXM

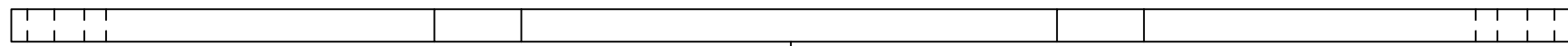

TOP



FRONT

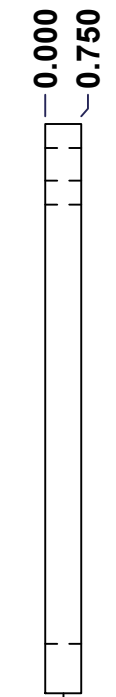

RIGHT

No.	Revisions	Date	By/Par

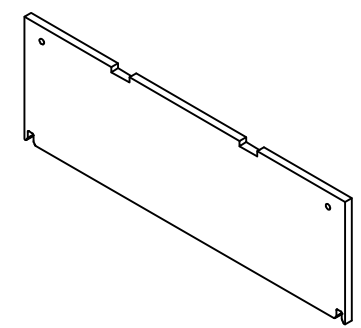

Isometric View



Tél: (450) 979-4373
 Fax: (450) 979-4626
www.exmweb.com

Flatness
Aplatissement
Max 3.0mm
Projection

Customer Client	Date
Drawn By / Dessiné Par: BoxCad: BoxCad	Date: 4/3/2024
Material / Matière: Polyisocyanurate	
Color / Couleur: Aluminum	Finish / Fini: Smooth
Description: 5412ESDG 48" x 36"Top Insulation	Detail Rev.
Part Number / Numéro Pièce: 5412ESDG483612THI-TP	Rev. 0

SEE BILL OF MATERIAL ON LAST PAGE

This drawing is confidential and must not be reproduced or used without the consent of EXM

Ce dessin est confidentiel et ne doit pas être reproduit ou utilisé sans le consentement de EXM

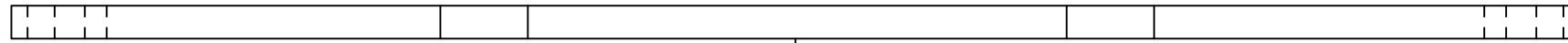

TOP

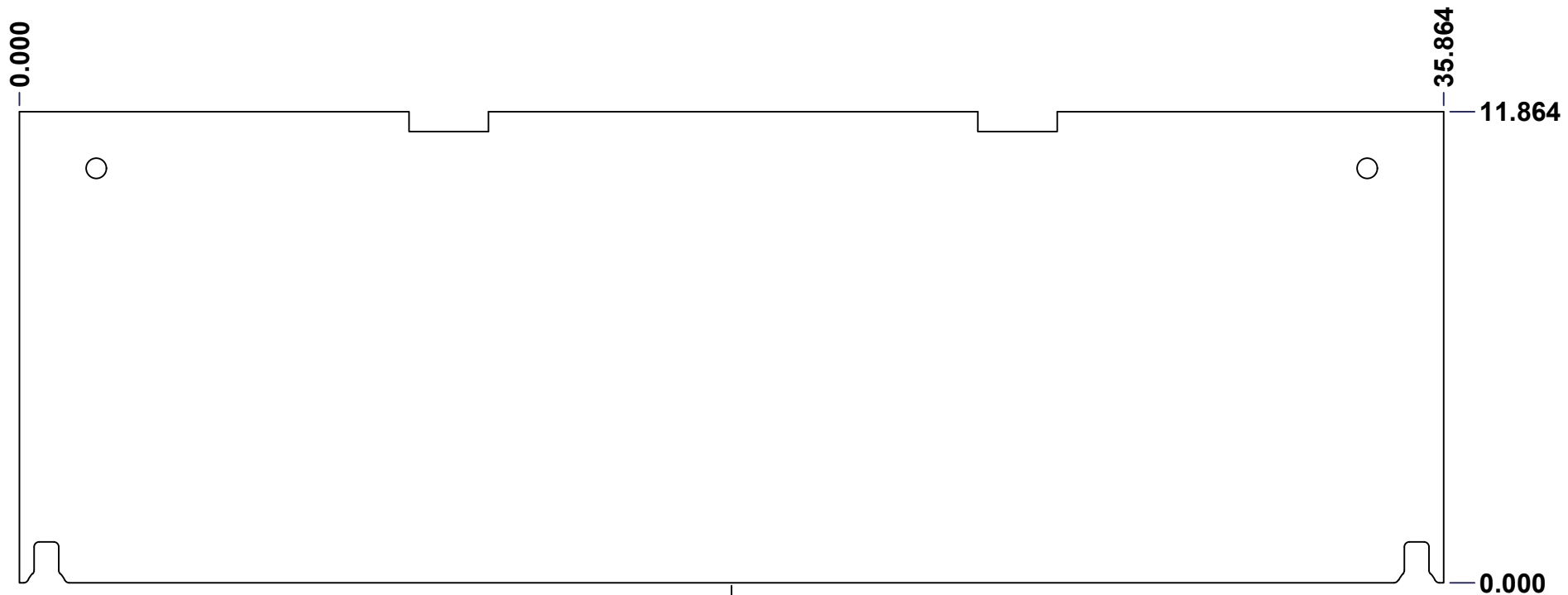

FRONT

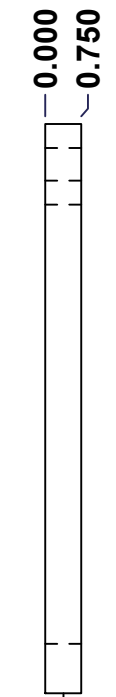

RIGHT

No.	Revisions	Date	By/Par

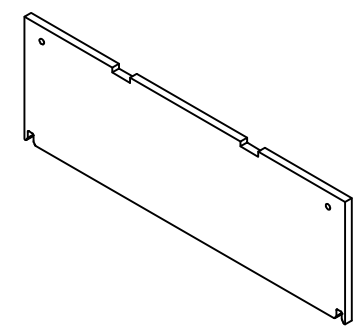

Isometric View



Tél: (450) 979-4373
 Fax: (450) 979-4626
www.exmweb.com

Flatness
Aplatissement
Max 3.0mm
Projection

Customer Client	Date
Drawn By Dessiné Par BoxCad: BoxCad	Date 4/3/2024
Material Matière Polyisocyanurate	
Color Couleur Aluminum	Finish Fini Smooth
Description 5412ESDG 48" x 36"Bottom Insulation	Detail Rev.
Part Number Numéro Pièce 5412ESDG483612THI-BT	Rev. 15 0

SEE BILL OF MATERIAL ON LAST PAGE

This drawing is confidential and must not be reproduced or used without the consent of EXM

Ce dessin est confidentiel et ne doit pas être reproduit ou utilisé sans le consentement de EXM

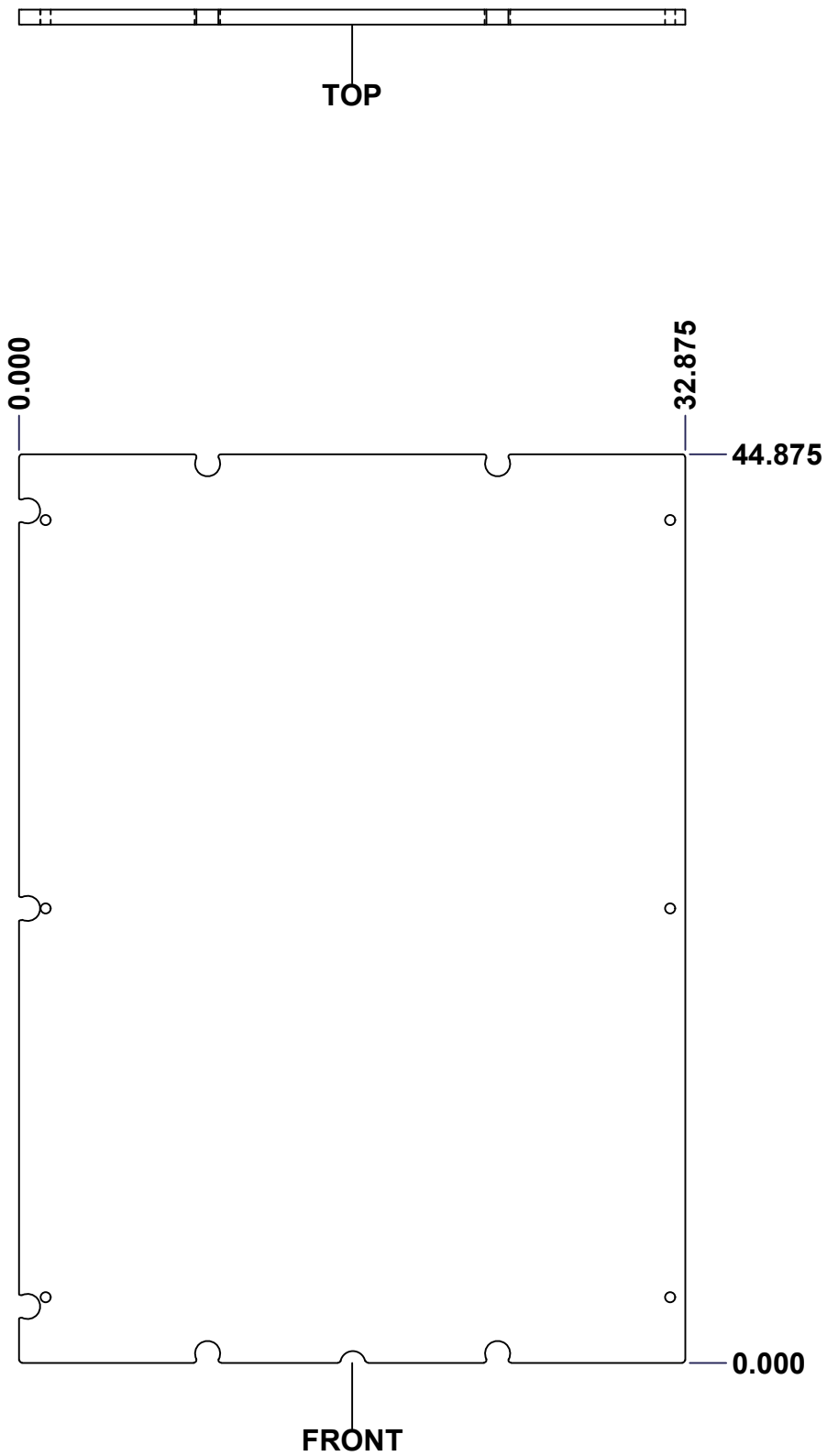

No.	Revisions	Date	By/Par

Isometric View

Tél: (450) 979-4373 Fax: (450) 979-4626 www.exmweb.com		Flatness Aplatissement
		Max 3.0mm
Customer Client		Date
Drawn By Dessiné Par BoxCad: Patrick Deschenes		Date 23-Jan-07
Material Matière Polyisocyanurate		
Color Couleur Aluminum	Finish Fini N/A	
Description 5412ESDG 48" x 36" Cover Insulation		Detail Rev.
Part Number Numéro Pièce 5412ESDG483612THI-C	Rev. 0	16 / 16

SEE BILL OF MATERIAL ON LAST PAGE

This drawing is confidential and must not be reproduced or used without the consent of EXM

Ce dessin est confidentiel et ne doit pas être reproduit ou utilisé sans le consentement de EXM

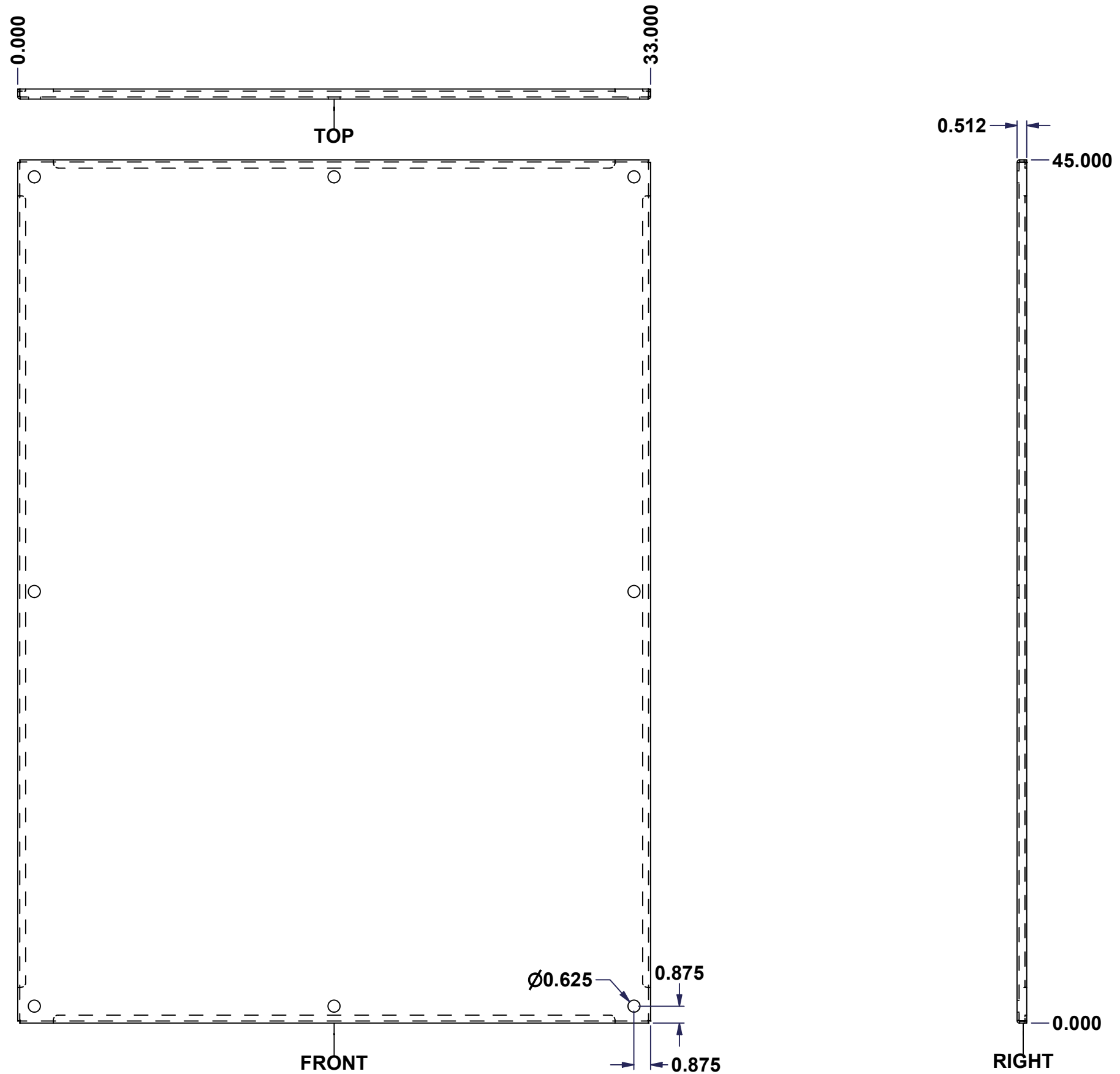

No.	Revisions	Date	By/Par

Isometric View

Tél: (450) 979-4373 Fax: (450) 979-4626 www.exmweb.com		Flatness Aplatissement
		Max 3.0mm
Projection		Date
Customer Client	BoxCad: nickz	Date 01/03/2017
Material Matière	12 Ga Galvanized (2.5mm)	
Color Couleur	See Part List	Finish Fini See Part List
Description		Detail Rev.
885SP 48" x 36" Inner Panel Part		
Part Number Numéro Pièce	885SP4836G	Rev. 1
		0

Qty	Part Number	Rev	Description	Material	Color	Finish
1	885SP4836G-P	0	885SP 48" x 36" Inner Panel Part	12 Ga Galvanized (2.5mm)	Unpainted	Galvanized

Parts List