

This drawing is confidential and must not be reproduced or used without the consent of EXM

Ce dessin est confidentiel et ne doit pas être reproduit ou utilisé sans le consentement de EXM

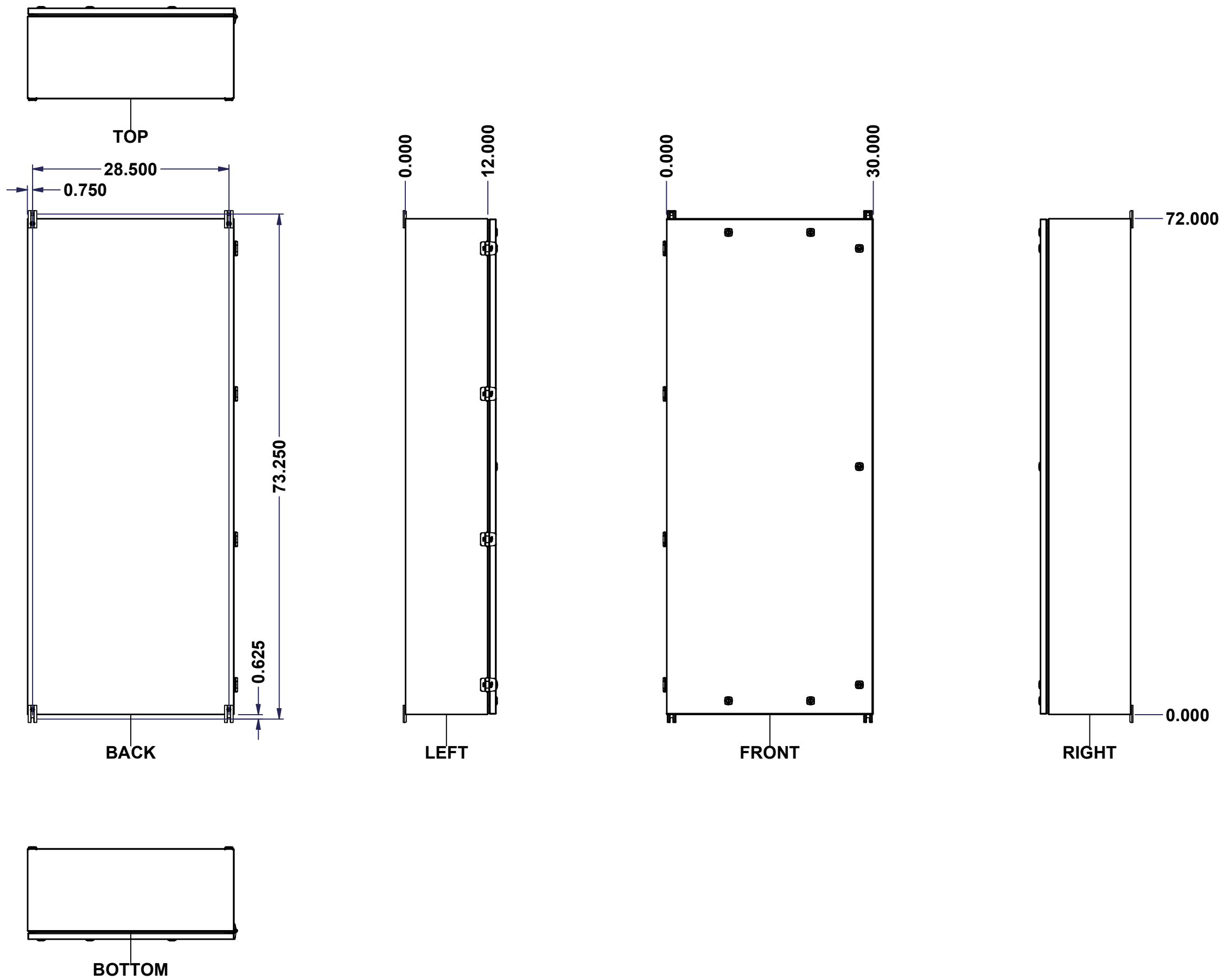

No.	Revisions	Date	By/Par

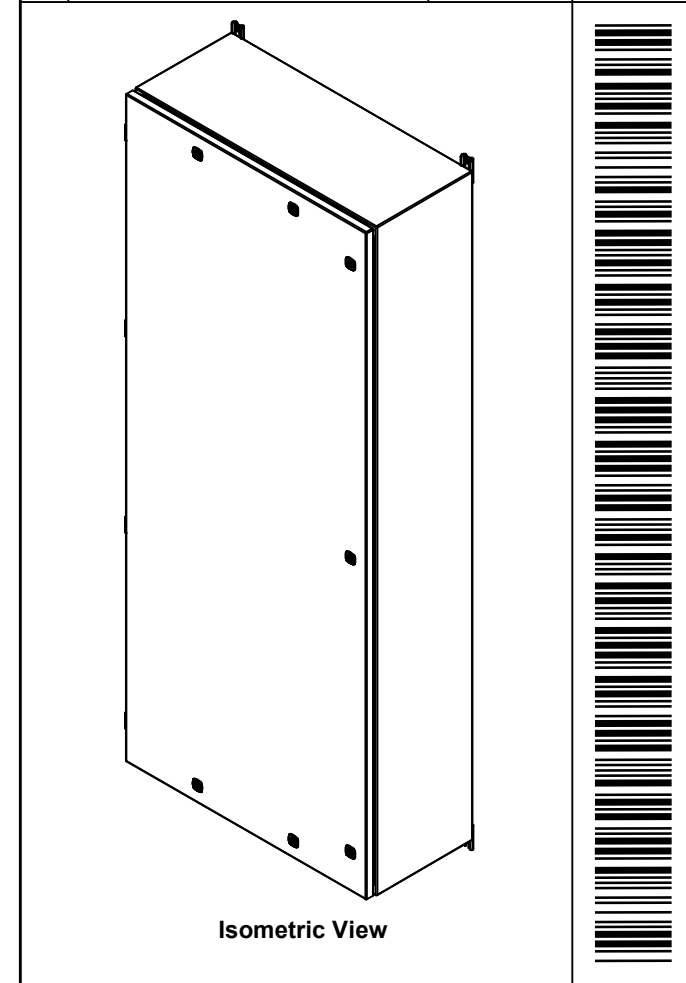

Tél: (450) 979-4373 Fax: (450) 979-4626 <a href="http://www.exmweb.com">www.exmweb.com</a>		Flatness Aplatissement	
		Max 3.0mm	
Customer Client		Date	
Drawn By Dessiné Par BoxCad: BoxCad		Date 03-Jan-25	
Material Matière 14 Ga Cold Rolled A1008 CS Type B (1.7mm)			
Color Couleur Asa-61 Grey		Finish Fini Smooth	
Description 5412ESDG 72" x 30" x 12" Assembly			Detail Rev.
Part Number Numéro Pièce <b>5412ESDG723012TH</b>		Rev. <b>0</b>	1 / 16

SEE BILL OF MATERIAL ON LAST PAGE

This drawing is confidential and must not be reproduced or used without the consent of EXM

Ce dessin est confidentiel et ne doit pas être reproduit ou utilisé sans le consentement de EXM

NOTE	
ITEM	DESCRIPTION
1	NEMA 4, 12 Enclosure (IP66)
2	C/W Standard ground studs on box and cover
3	C/W Standard door stiffener
4	C/W Standard inner panel (Included)
5	C/W Standard inner panel mounting studs
6	C/W 885 ESMF3_OPEN Sold separately (Installed)
7	C/W 885 ESMF3_CLOSE Sold separately (Installed)
8	C/W R5 Insulation (Installed aluminum visible)

No.	Revisions	Date	By/Par

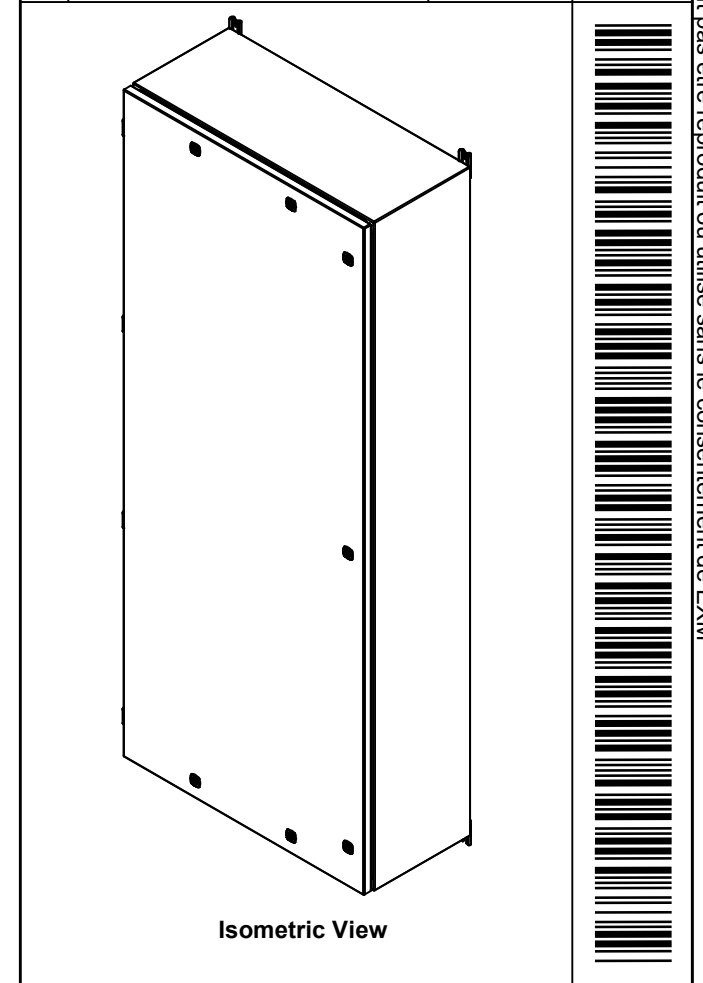

PACKING		
ITEM	QTY	DESCRIPTION
Cardboard sleeve	2	Top and Bottom
Cardboard strip	2	Between back of enclosure and inner panel
Plastic bag	1	To protect cover surface and inside gasket
Cardboard corner	4	To reinforced for the plastic strap tightening
Plastic strap - Black	2	To Squeeze the 2 cardboard sleeve together
Packaging label	3	White label with PN
Plastic strap- Green	2	To secure the enclosure to the wood pallet
Wood Pallet	1	2" deeper and 3" larger than enclosure size

6	STK-Q-00600	2	M12 to M8 Adaptor
1	885SP7230G	0	885SP 72" x 30" Inner Panel Part
1	STK-K-01800	5	5412 ES Accessory Kit
4	STK-Q-10252	0	M6 Stainless Steel Sealing Washer
1	5412ESDG723012THC	0	5412ESDG 72" x 30" Cover
1	5412ESDG723012THB	0	5412ESDG 72" x 30" x 12" Body
4	STK-Q-07220	1	M6 Nylon Insert Lock Nut
Qty	Part Number	Rev	Description
Parts List			

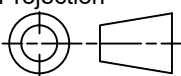
 Tél: (450) 979-4373 Fax: (450) 979-4626 <a href="http://www.exmweb.com">www.exmweb.com</a>		Flatness Aplatissement Max 3.0mm Projection 
Customer Client	Date	
Drawn By Dessiné Par	BoxCad: BoxCad	Date 03-Jan-25
Material Matière	14 Ga Cold Rolled A1008 CS Type B (1.7mm)	
Color Couleur	Asa-61 Grey	Finish Fini Smooth
Description		Detail Rev.
5412ESDG 72" x 30" x 12" Assembly		
Part Number Numéro Pièce	Rev.	2
<b>5412ESDG723012TH</b>	<b>0</b>	16

This drawing is confidential and must not be reproduced or used without the consent of EXM

Ce dessin est confidentiel et ne doit pas être reproduit ou utilisé sans le consentement de EXM

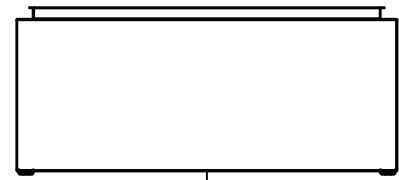

TOP

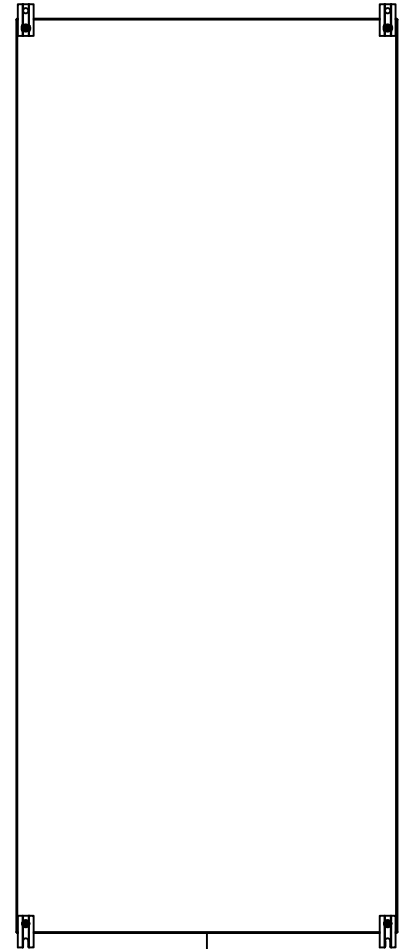

BACK

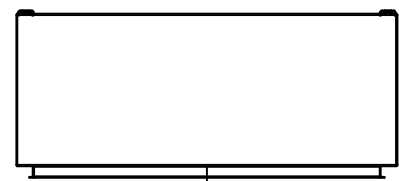

BOTTOM

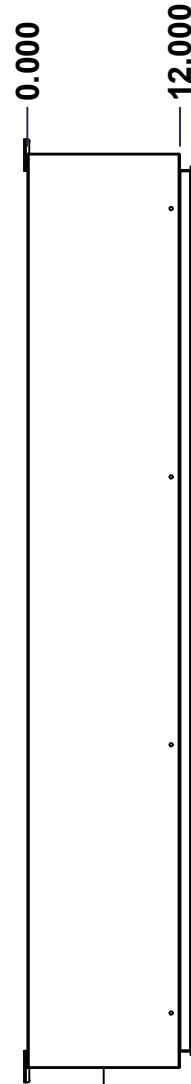

LEFT

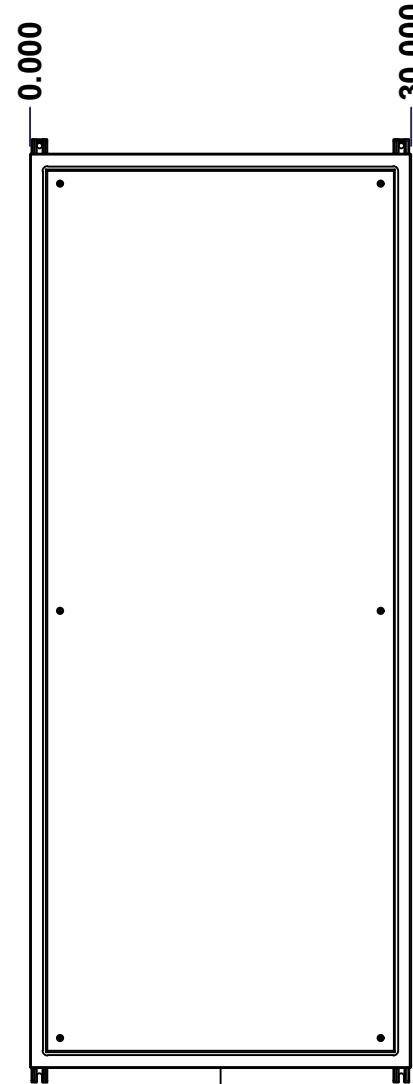

FRONT

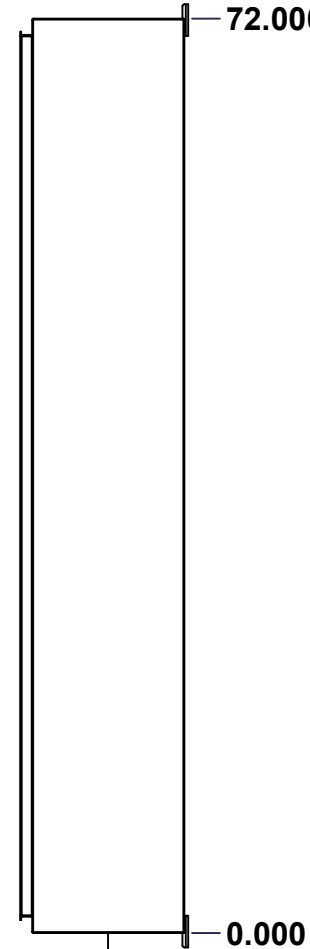

RIGHT

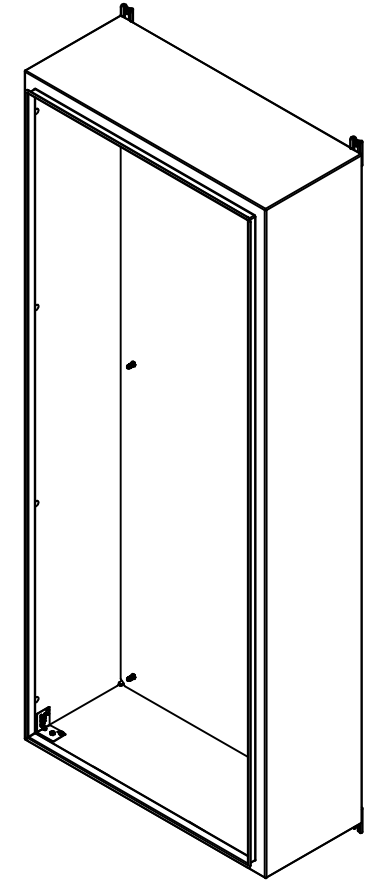

Isometric View

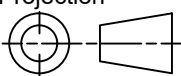

No.	Revisions	Date	By/Par

 Tél: (450) 979-4373 Fax: (450) 979-4626 <a href="http://www.exmweb.com">www.exmweb.com</a>		Flatness Aplatissement Max 3.0mm Projection 
Customer Client	Date	
Drawn By Dessiné Par	BoxCad: BoxCad	Date 03-Jan-25
Material Matière	14 Ga Cold Rolled A1008 CS Type B (1.7mm)	
Color Couleur	Asa-61 Grey	Finish Fini Smooth
Description	Detail Rev.	
5412ESDG 72" x 30" x 12" Body		
Part Number Numéro Pièce	Rev. 0	3 / 16
<b>5412ESDG723012THB</b>		

SEE BILL OF MATERIAL ON LAST PAGE

This drawing is confidential and must not be reproduced or used without the consent of EXM

Ce dessin est confidentiel et ne doit pas être reproduit ou utilisé sans le consentement de EXM

<b>STANDARD FEATURES ARE NOT LISTED IN THIS HOLE TABLE</b>			
<b>HOLE TABLE - TOP VIEW (CUSTOM FEATURE ONLY)</b>			
CUT-OUT	XDIM	YDIM	DESCRIPTION
1	2.000	10.500	INSUL. STUD M6 x 18mm (Inside)
2	28.000	10.500	INSUL. STUD M6 x 18mm (Inside)

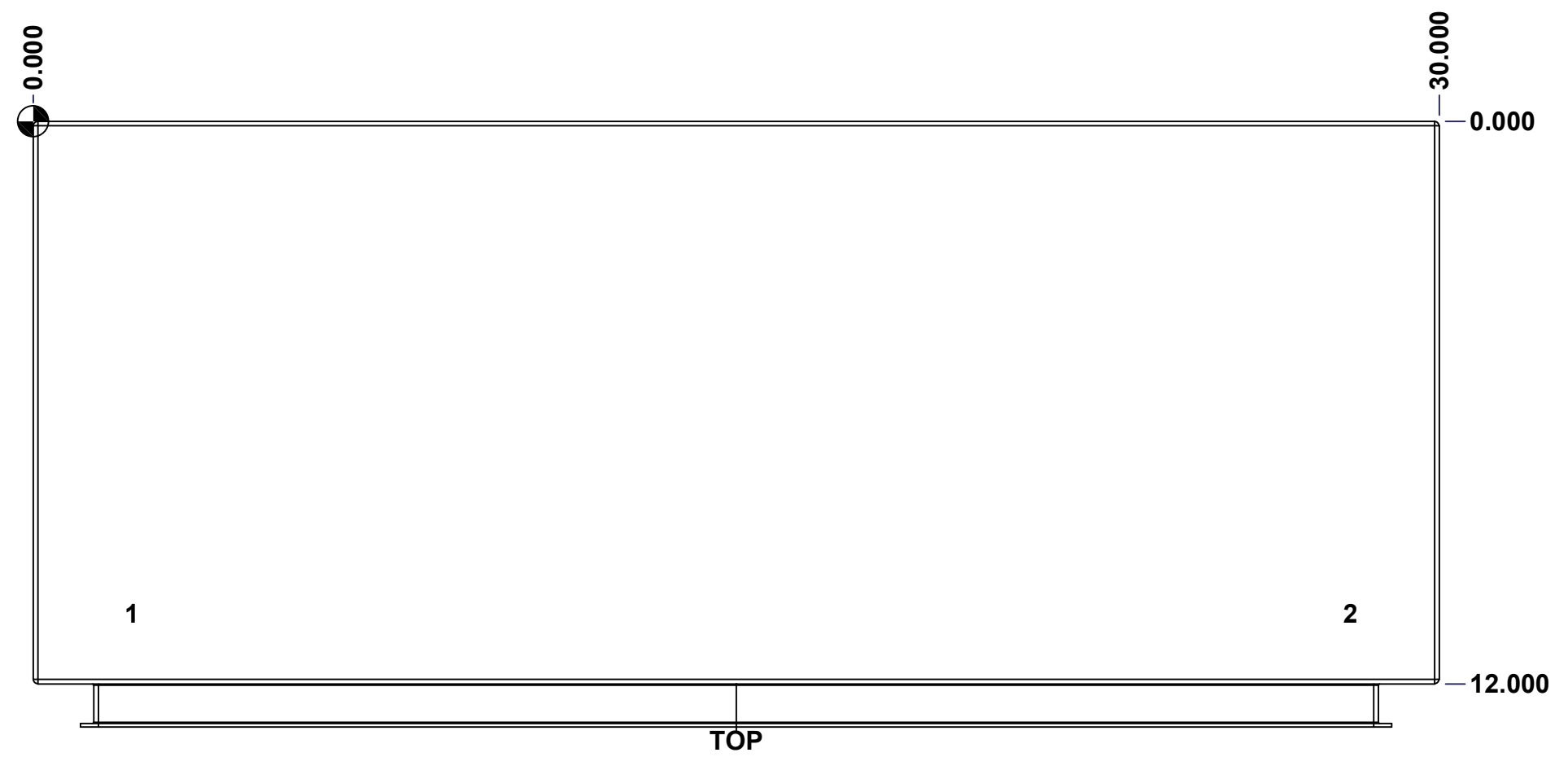

	Description	Status
	5412ESDG 72" x 30" x 12" Body	(NULL)
Part Number Numéro Pièce <b>5412ESDG723012THB</b>	Rev.	4
	<b>0</b>	16

This drawing is confidential and must not be reproduced or used without the consent of EXM

Ce dessin est confidentiel et ne doit pas être reproduit ou utilisé sans le consentement de EXM

<b>STANDARD FEATURES ARE NOT LISTED IN THIS HOLE TABLE</b>			
<b>HOLE TABLE - BOTTOM VIEW (CUSTOM FEATURE ONLY)</b>			
CUT-OUT	XDIM	YDIM	DESCRIPTION
1	2.000	10.500	INSUL. STUD M6 x 18mm (Inside)
2	28.000	10.500	INSUL. STUD M6 x 18mm (Inside)



	Description		Status
	5412ESDG 72" x 30" x 12" Body		(NULL)
Part Number Numéro Pièce		Rev.	5
<b>5412ESDG723012THB</b>		<b>0</b>	16

This drawing is confidential and must not be reproduced or used without the consent of EXM

Ce dessin est confidentiel et ne doit pas être reproduit ou utilisé sans le consentement de EXM

**STANDARD FEATURES ARE NOT LISTED IN THIS HOLE TABLE**

**HOLE TABLE - BACK VIEW (CUSTOM FEATURE ONLY)**

CUT-OUT	XDIM	YDIM	DESCRIPTION
1	2.375	2.375	IP STUD M8 x 35mm (Inside)
2	2.375	69.625	IP STUD M8 x 35mm (Inside)
3	27.625	69.625	IP STUD M8 x 35mm (Inside)
4	27.625	2.375	IP STUD M8 x 35mm (Inside)
5	2.375	36.000	IP STUD M8 x 35mm (Inside)
6	27.625	36.000	IP STUD M8 x 35mm (Inside)
-----			
7	29.250	0.000	FOOT 885 ESMF3_OPEN
8	0.750	0.000	FOOT 885 ESMF3_OPEN
9	29.250	72.000	FOOT 885 ESMF3_CLOSE
10	0.750	72.000	FOOT 885 ESMF3_CLOSE

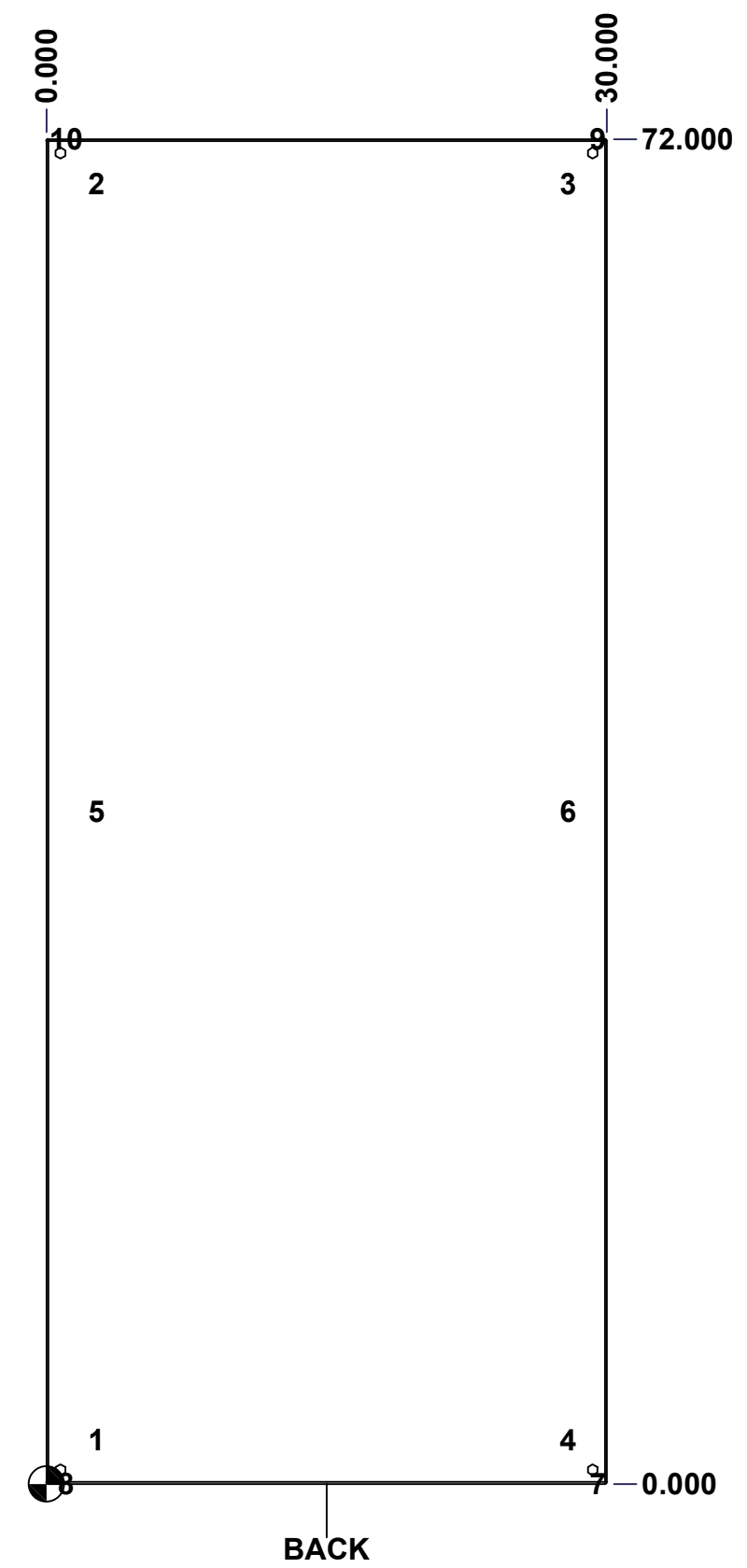

	Description	Status
	5412ESDG 72" x 30" x 12" Body	(NULL)
	Part Number Numéro Pièce	Rev.
	<b>5412ESDG723012THB</b>	<b>0</b> / 6
		16

This drawing is confidential and must not be reproduced or used without the consent of EXM

Ce dessin est confidentiel et ne doit pas être reproduit ou utilisé sans le consentement de EXM

No.	Revisions	Date	By/Par

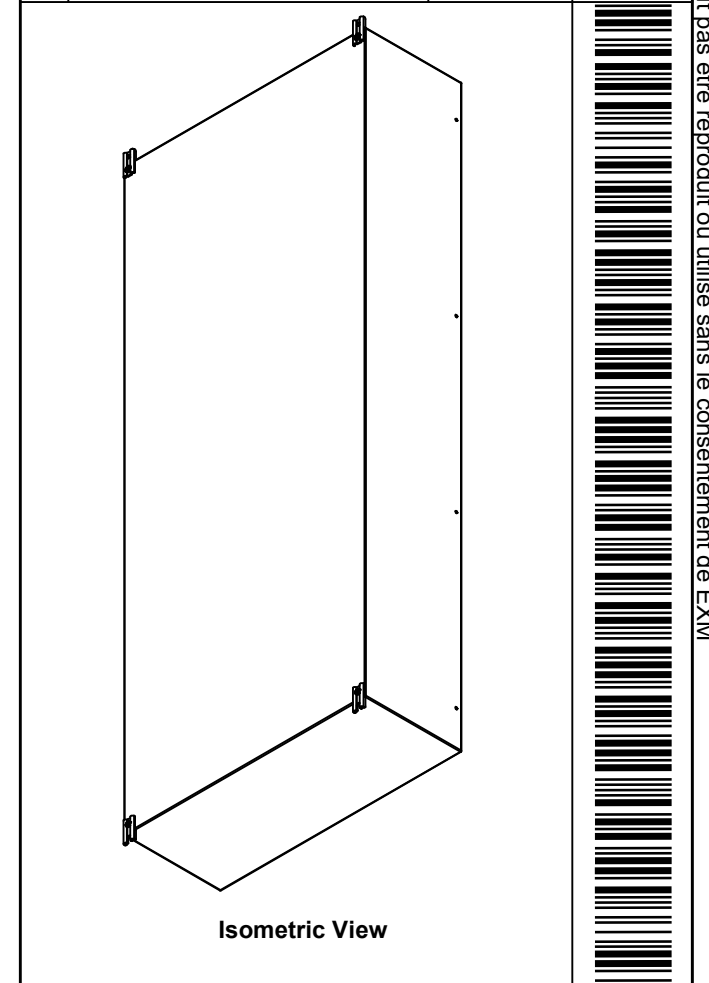

1	885 ESMF3	0	885 ESMF3 Mounting Foot Kit
4	RIVET_NUT_M10_FH_CE	0	Rivet Nut M10 (Low Profile Close End)
1	STK-K-70554	3	5412 ESTH Accessory Kit
1	5412ESDG723012THI-RS	0	5412ESDG 72" x 30" Right Insulation
1	5412ESDG723012THI-LS	0	5412ESDG 72" x 30" Left Insulation
1	5412ESDG723012THI-BT	0	5412ESDG 72" x 30" Bottom Insulation
1	5412ESDG723012THI-TP	0	5412ESDG 72" x 30" Top Insulation
1	5412ESDG723012THI-B	0	5412ESDG 72" x 30" Back Insulation
4	STK-Q-16055	1	M6 x 18mm Stud (No Paint Cap Required)
1	STK-P-02400S	0	Powder Paint (Asa-61 Grey / Smooth)
6	STK-Q-16005	0	Stud M8 x 35mm Steel
1	5412ESDG723012THB-P	0	5412ESDG 72" x 30" x 12" Body Part
Qty	Part Number	Rev	Description
Parts List			

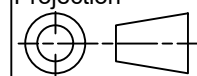
 Tél: (450) 979-4373 Fax: (450) 979-4626 <a href="http://www.exmweb.com">www.exmweb.com</a>		Flatness Aplatissement Max 3.0mm
Projection 		Customer Client
Drawn By Dessiné Par BoxCad: BoxCad		Date 03-Jan-25
Material Matière 14 Ga Cold Rolled A1008 CS Type B (1.7mm)		
Color Couleur Asa-61 Grey	Finish Fini Smooth	
Description 5412ESDG 72" x 30" x 12" Body		Detail Rev.
Part Number Numéro Pièce <b>5412ESDG723012THB</b>		Rev. 7 <b>0</b>
		16

This drawing is confidential and must not be reproduced or used without the consent of EXM

Ce dessin est confidentiel et ne doit pas être reproduit ou utilisé sans le consentement de EXM

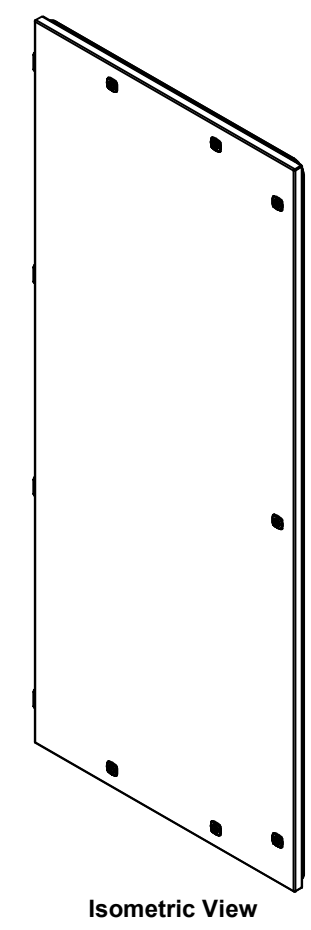
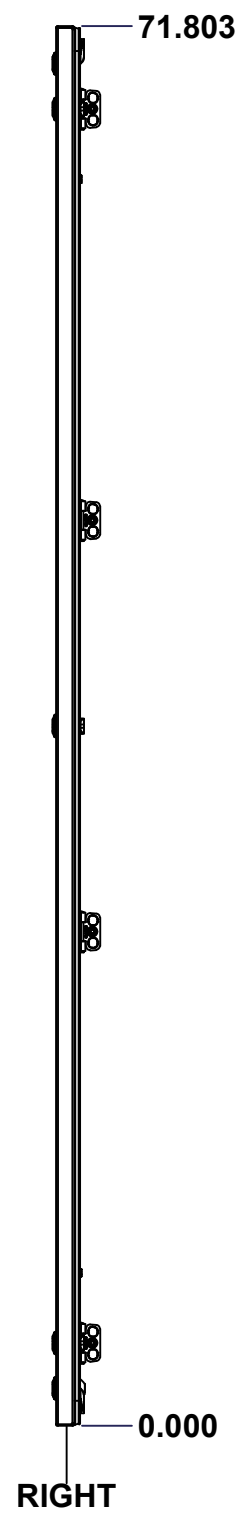
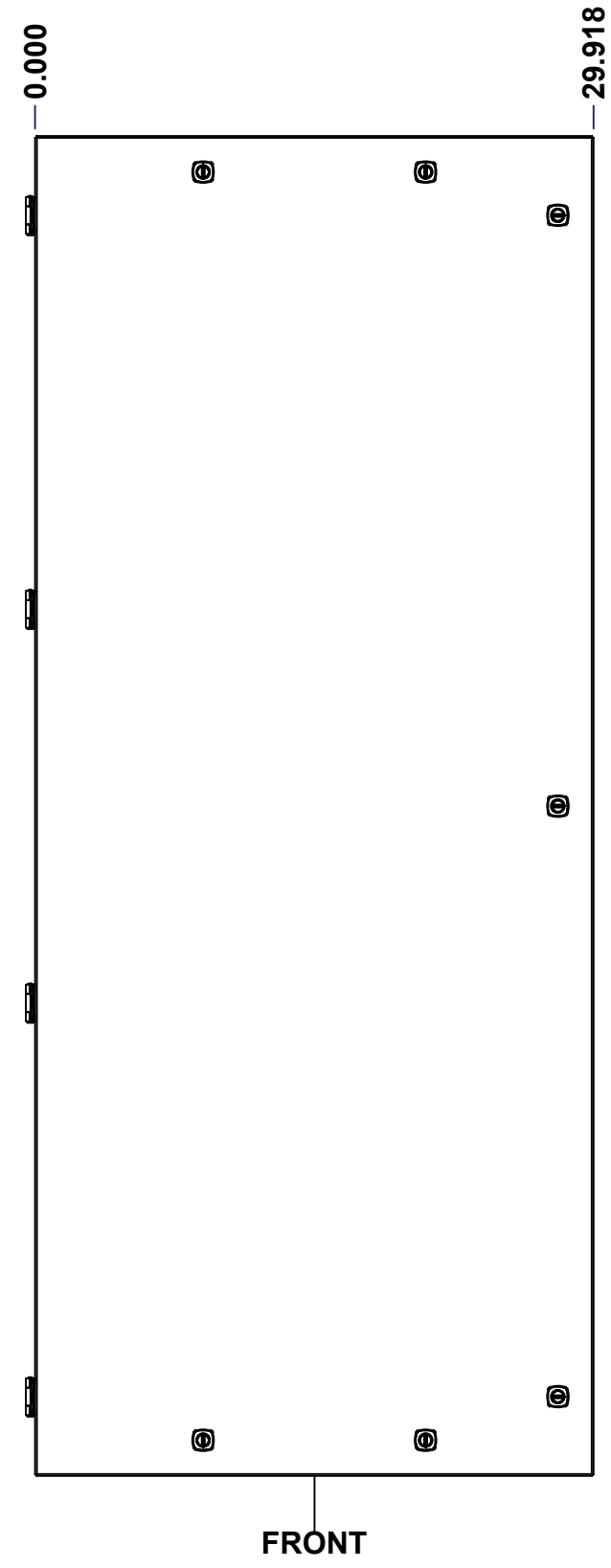
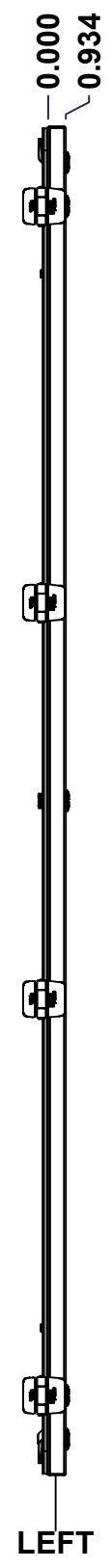
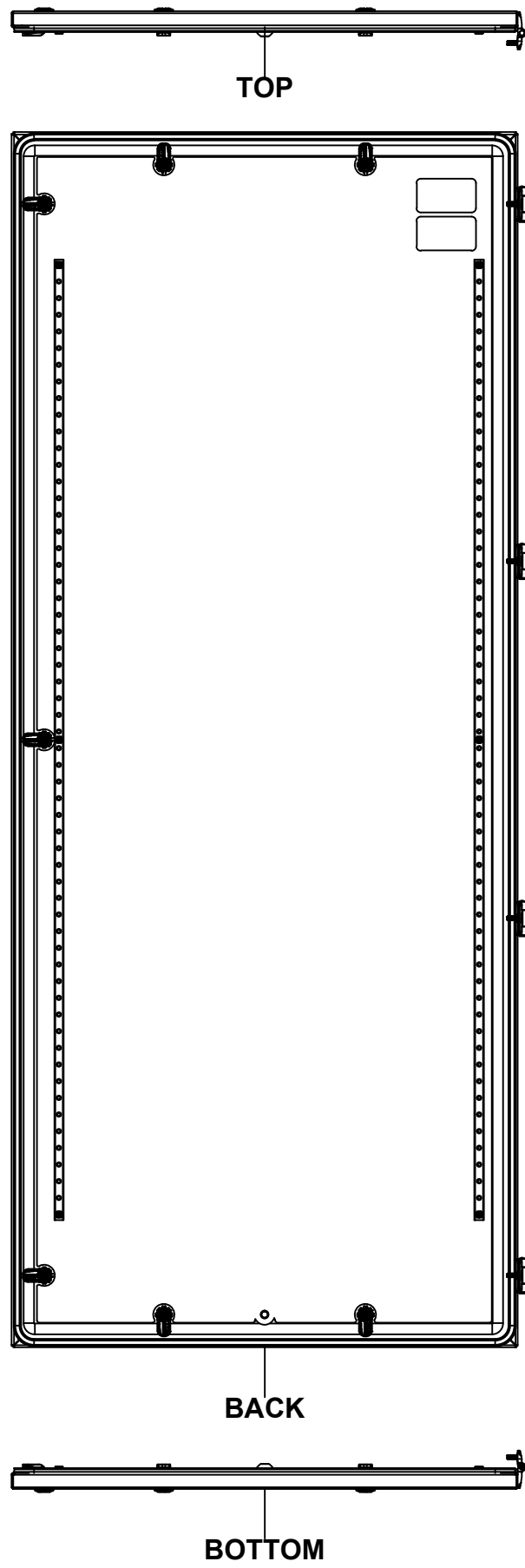

No.	Revisions	Date	By/Par

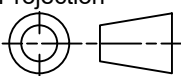
 Tél: (450) 979-4373 Fax: (450) 979-4626 <a href="http://www.exmweb.com">www.exmweb.com</a>		Flatness Aplatissement Max 3.0mm Projection 
Customer Client	Date	
Drawn By Dessiné Par	BoxCad: BoxCad	Date 03-Jan-25
Material Matière	14 Ga Cold Rolled A1008 CS Type B (1.7mm)	
Color Couleur	Asa-61 Grey	Finish Fini Smooth
Description 5412ESDG 72" x 30" Cover		Detail Rev.
Part Number Numéro Pièce	Rev. 0	8 / 16

SEE BILL OF MATERIAL ON LAST PAGE

**5412ESDG723012THC**

This drawing is confidential and must not be reproduced or used without the consent of EXM

Ce dessin est confidentiel et ne doit pas être reproduit ou utilisé sans le consentement de EXM

**STANDARD FEATURES ARE NOT LISTED IN THIS HOLE TABLE**

**HOLE TABLE - FRONT VIEW (CUSTOM FEATURE ONLY)**

CUT-OUT	XDIM	YDIM	DESCRIPTION
1	2.286	7.850	STUD M6 x 18mm (Inside)
2	2.286	63.953	STUD M6 x 18mm (Inside)
3	27.117	63.953	STUD M6 x 18mm (Inside)
4	27.117	7.850	STUD M6 x 18mm (Inside)
5	2.286	35.902	STUD M6 x 18mm (Inside)
6	27.117	35.902	STUD M6 x 18mm (Inside)
7	14.959	1.935	STUD M6 x 18mm (Inside)
-----			
8	27.994	67.553	LOCK 880 SCQ4-SL @ 0.0°
9	27.994	35.902	LOCK 880 SCQ4-SL @ 0.0°
10	27.994	4.250	LOCK 880 SCQ4-SL @ 0.0°
11	9.000	69.879	LOCK 880 SCQ4-SL @ 90.0°
12	20.918	69.879	LOCK 880 SCQ4-SL @ 90.0°
13	9.000	1.924	LOCK 880 SCQ4-SL @ 270.0°
14	20.918	1.924	LOCK 880 SCQ4-SL @ 270.0°

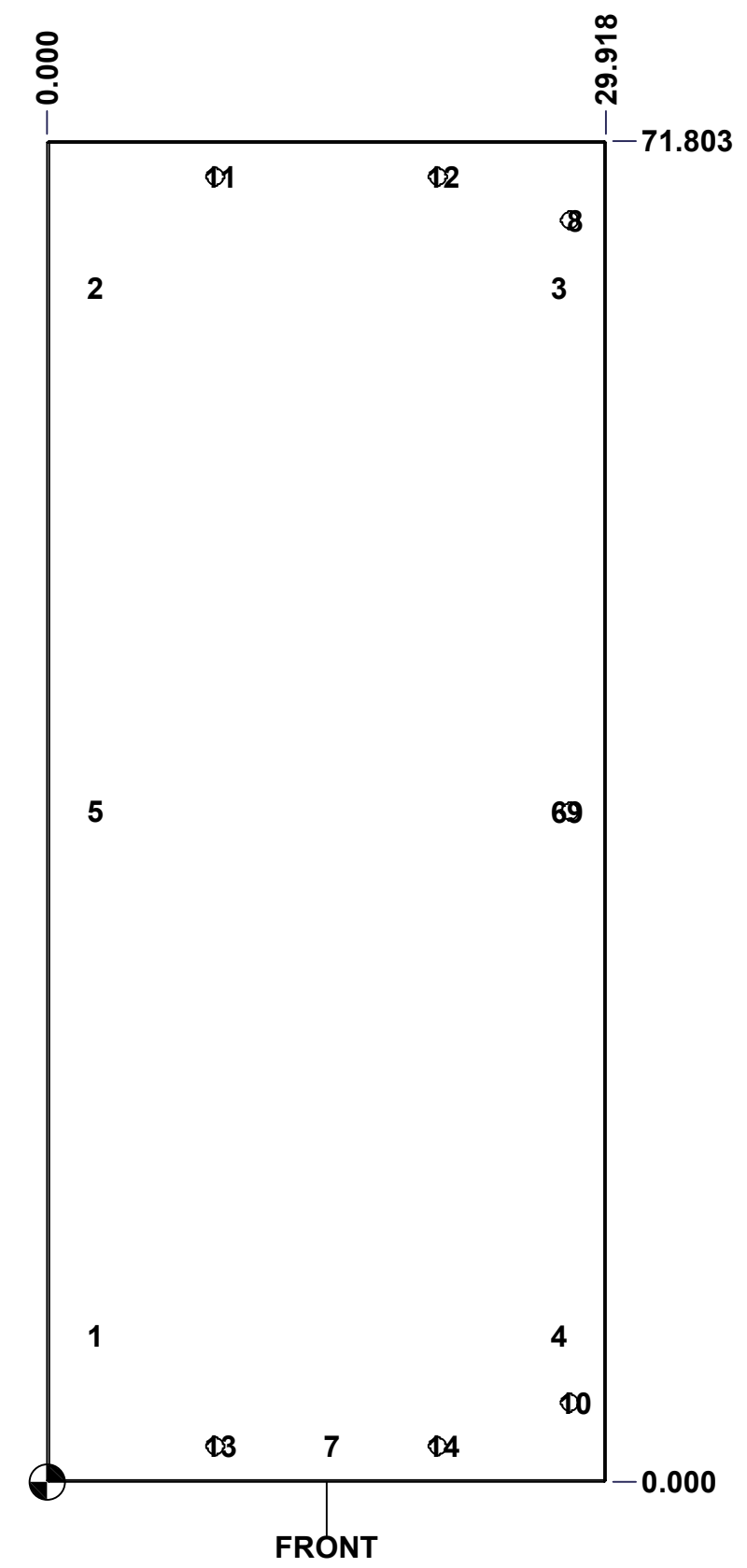

	Description	Status
	5412ESDG 72" x 30" Cover	(NULL)
Part Number Numéro Pièce <b>5412ESDG723012THC</b>	Rev.	9
	<b>0</b>	16

This drawing is confidential and must not be reproduced or used without the consent of EXM

Ce dessin est confidentiel et ne doit pas être reproduit ou utilisé sans le consentement de EXM

No.	Revisions	Date	By/Par

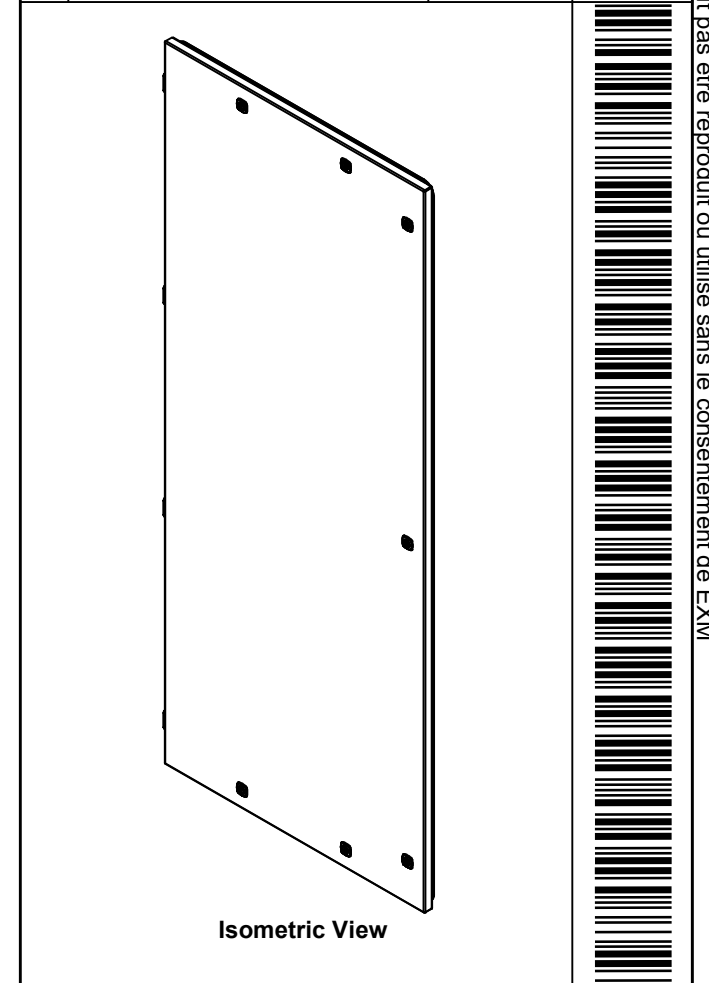

7	STK-K-12500	19	5412 ES 1/4 Turn Lock
2	STK-S-00100	0	3.5" x 2" Silver Milar Flexcon Sticker
6	STK-Q-07250	2	M6 x 16mm Collar Nut
2	STK-Q-46020-60	5	5412 ES Vertical Door Stiffener 60"
1	5412ESDG723012THI-C	0	5412ESDG 72" x 30" Cover Insulation
1	STK-P-02400S	0	Powder Paint (Asa-61 Grey / Smooth)
1	STK-Q-46515	3	5412 ES Door Support with Brass Insert
7	STK-Q-16055	1	M6 x 18mm Stud (No Paint Cap Required)
1	5412ESDG723012THG2	0	5412ESDG 72" x 30" Cover Gasket
1	5412ESDG723012THG	0	5412ESDG 72" x 30" Cover Gasket
1	5412ESDG723012THC-P	0	5412ESDG 72" x 30" Cover Part
4	STK-A-02360	0	External Hinge for Double Gasket
4	STK-Q-07220	1	M6 Nylon Insert Lock Nut
4	STK-Q-10252	0	M6 Stainless Steel Sealing Washer

QTY	Part Number	Rev	Description
Parts List			

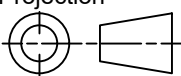
 Tél: (450) 979-4373 Fax: (450) 979-4626 <a href="http://www.exmweb.com">www.exmweb.com</a>	Flatness Aplatissement	Max 3.0mm
	Projection	
Customer Client	Date	
Drawn By Dessiné Par	BoxCad: BoxCad	Date 03-Jan-25
Material Matière	14 Ga Cold Rolled A1008 CS Type B (1.7mm)	
Color Couleur	Asa-61 Grey	Finish Fini Smooth
Description	Detail Rev.	
5412ESDG 72" x 30" Cover		
Part Number Numéro Pièce	Rev. 0	10 / 16
<b>5412ESDG723012THC</b>		

This drawing is confidential and must not be reproduced or used without the consent of EXM

Ce dessin est confidentiel et ne doit pas être reproduit ou utilisé sans le consentement de EXM

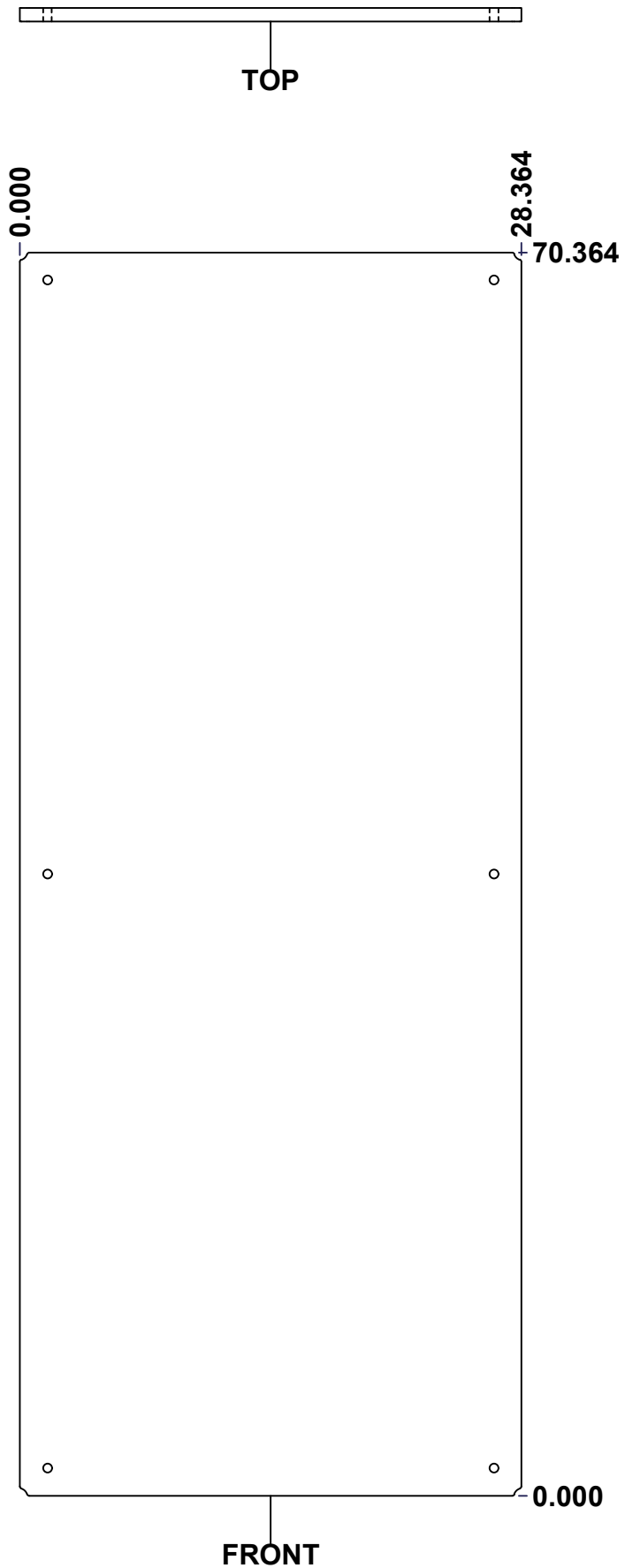

No.	Revisions	Date	By/Par

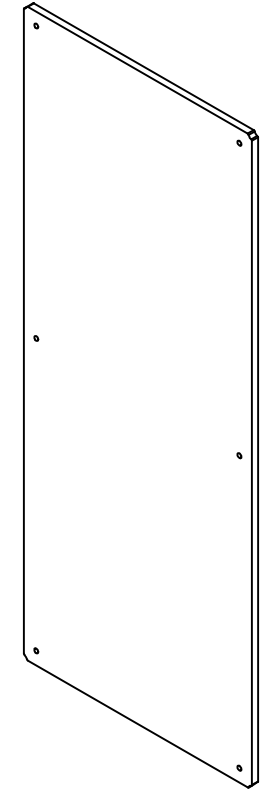

Isometric View

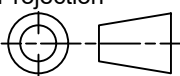

 Tél: (450) 979-4373 Fax: (450) 979-4626 <a href="http://www.exmweb.com">www.exmweb.com</a>	Flatness Aplatissement	Max 3.0mm
	Projection	
Customer Client	Date	
Drawn By Dessiné Par	BoxCad: Patrick Deschenes	Date 23-Jan-07
Material Matière	Polyisocyanurate	
Color Couleur	Aluminum	Finish Fini N/A
Description	Detail Rev.	
5412ESDG 72" x 30" Back Insulation		
Part Number Numéro Pièce	Rev.	11
5412ESDG723012TH-B	0	16

SEE BILL OF MATERIAL ON LAST PAGE

This drawing is confidential and must not be reproduced or used without the consent of EXM

Ce dessin est confidentiel et ne doit pas être reproduit ou utilisé sans le consentement de EXM

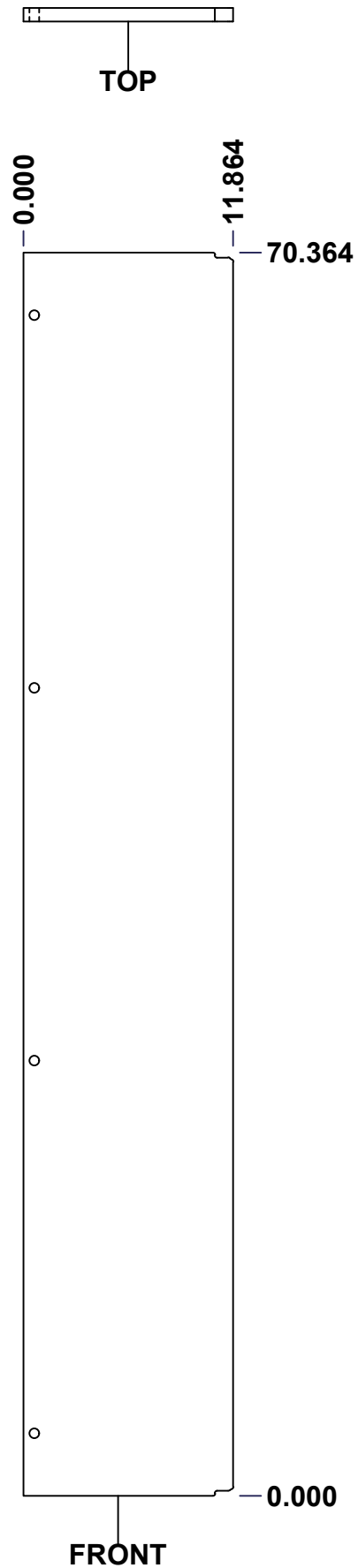

No.	Revisions	Date	By/Par

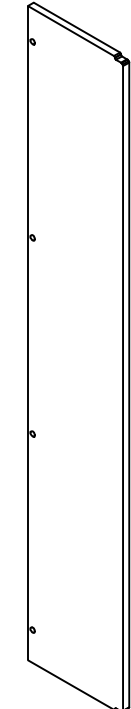

Isometric View

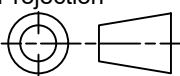

 Tél: (450) 979-4373 Fax: (450) 979-4626 <a href="http://www.exmweb.com">www.exmweb.com</a>	Flatness Aplatissement	Max 3.0mm
	Projection	
Customer Client	Date	
Drawn By Dessiné Par	BoxCad: Patrick Deschenes	Date 23-Jan-07
Material Matière	Polyisocyanurate	
Color Couleur	Aluminum	Finish Fini N/A
Description	Detail Rev.	
5412ESDG 72" x 30" Left Insulation		
Part Number Numéro Pièce	Rev. 0	12 / 16
<b>5412ESDG723012THI-LS</b>		

SEE BILL OF MATERIAL ON LAST PAGE

This drawing is confidential and must not be reproduced or used without the consent of EXM

Ce dessin est confidentiel et ne doit pas être reproduit ou utilisé sans le consentement de EXM

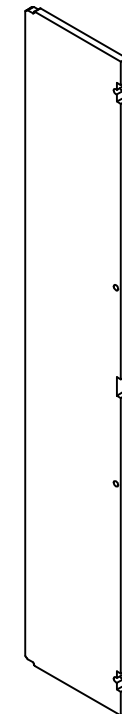
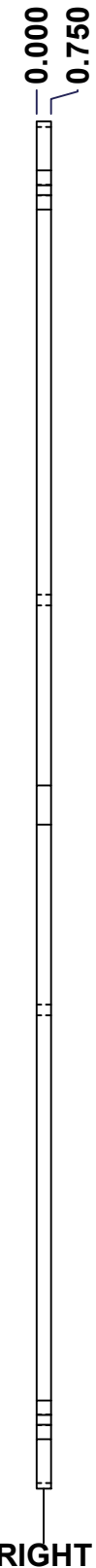
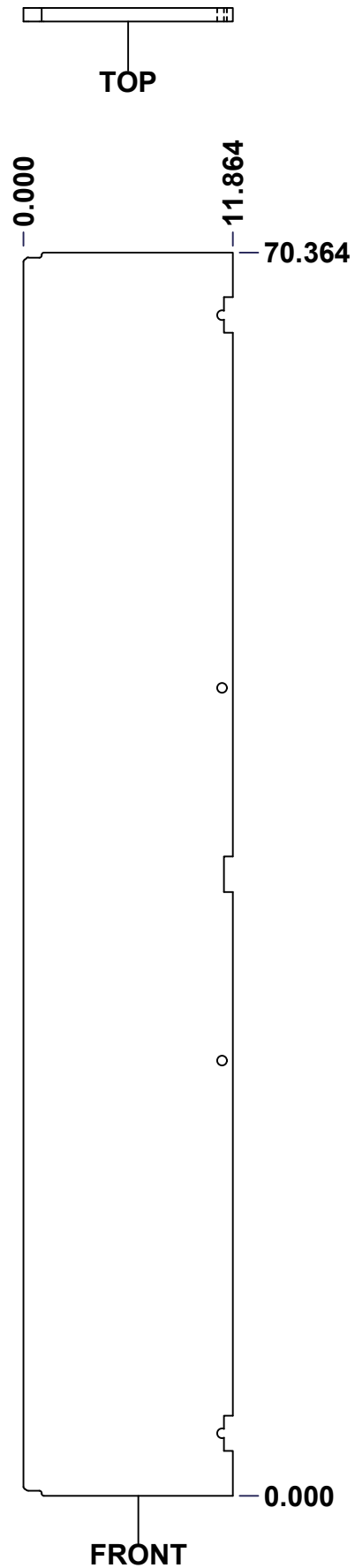

Isometric View



Tél: (450) 979-4373  
 Fax: (450) 979-4626  
[www.exmweb.com](http://www.exmweb.com)

Flatness  
Aplatissement

Max 3.0mm

Projection

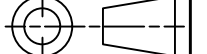

Customer Client	Date
Drawn By Dessiné Par BoxCad: Patrick Deschenes	Date 23-Jan-07
Material Matière Polyisocyanurate	
Color Couleur Aluminum	Finish Fini N/A
Description 5412ESDG 72" x 30" Right Insulation	Detail Rev.
Part Number Numéro Pièce 5412ESDG723012THI-RS	Rev. 13 0 16

SEE BILL OF MATERIAL ON LAST PAGE

This drawing is confidential and must not be reproduced or used without the consent of EXM

Ce dessin est confidentiel et ne doit pas être reproduit ou utilisé sans le consentement de EXM

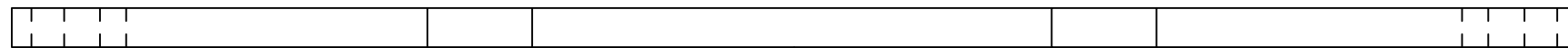

TOP

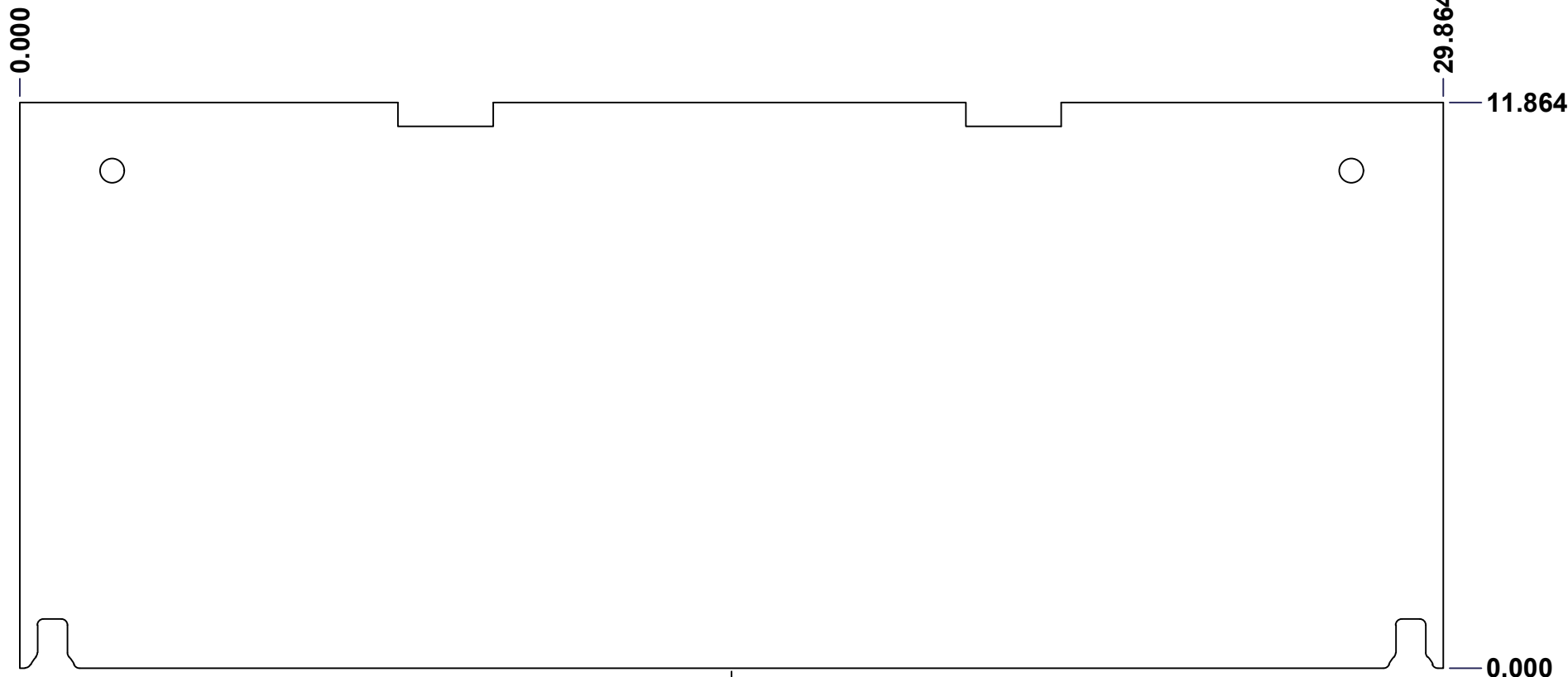

FRONT



RIGHT

No.	Revisions	Date	By/Par

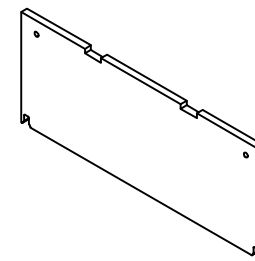

Isometric View



Tél: (450) 979-4373  
 Fax: (450) 979-4626  
[www.exmweb.com](http://www.exmweb.com)

Flatness  
Aplatissement

Max 3.0mm

Projection

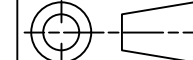

Customer Client	Date
Drawn By Dessiné Par BoxCad: BoxCad	Date 4/3/2024
Material Matière Polyisocyanurate	
Color Couleur Aluminum	Finish Fini Smooth
Description 5412ESDG 72" x 30"Top Insulation	Detail Rev.
Part Number Numéro Pièce <b>5412ESDG723012THI-TP</b>	Rev. <b>0</b>

14
16

SEE BILL OF MATERIAL ON LAST PAGE

This drawing is confidential and must not be reproduced or used without the consent of EXM

Ce dessin est confidentiel et ne doit pas être reproduit ou utilisé sans le consentement de EXM

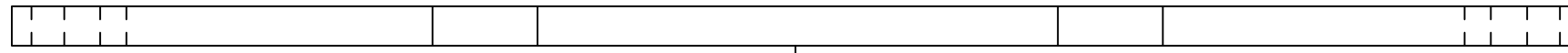

TOP

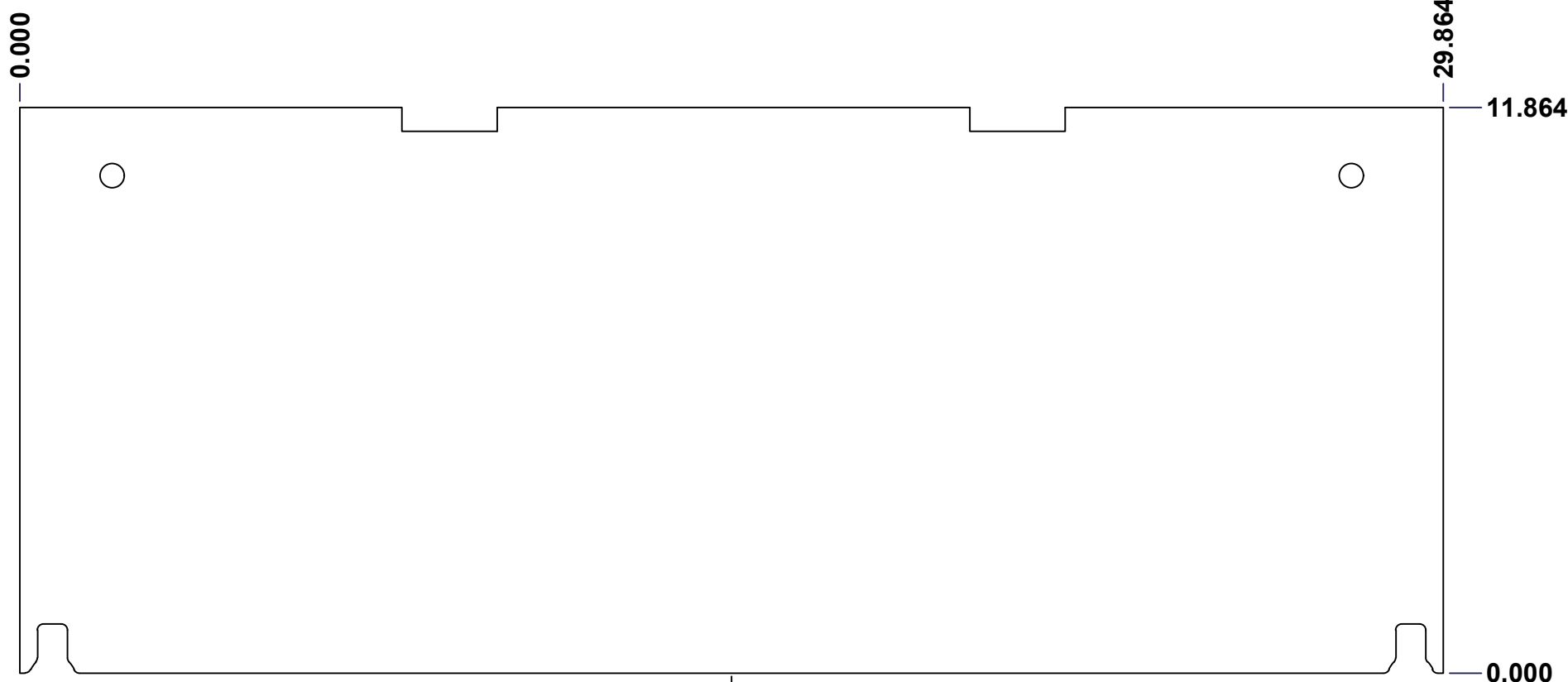

FRONT

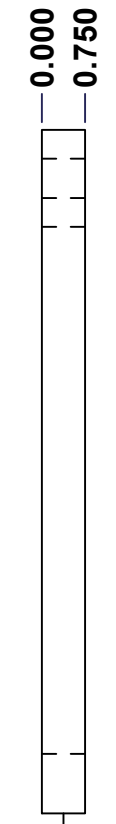

RIGHT

No.	Revisions	Date	By/Par

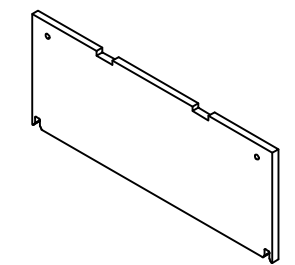

Isometric View

**EXM**  
exm

Tél: (450) 979-4373  
Fax: (450) 979-4626  
[www.exmweb.com](http://www.exmweb.com)

Flatness  
Aplatissement  
Max 3.0mm

Projection

Customer Client	Date
Drawn By Dessiné Par BoxCad: BoxCad	Date 4/3/2024

Material Matière Polyisocyanurate

Color Couleur Aluminum	Finish Fini Smooth
------------------------	--------------------

Description 5412ESDG 72" x 30"Bottom Insulation	Detail Rev.
--	-------------

Part Number Numéro Pièce	Rev. 0	15	16
-----------------------------	--------	----	----

SEE BILL OF MATERIAL ON LAST PAGE

**5412ESDG723012THI-BT**

This drawing is confidential and must not be reproduced or used without the consent of EXM

Ce dessin est confidentiel et ne doit pas être reproduit ou utilisé sans le consentement de EXM

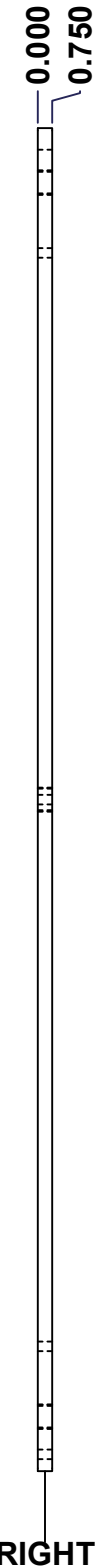
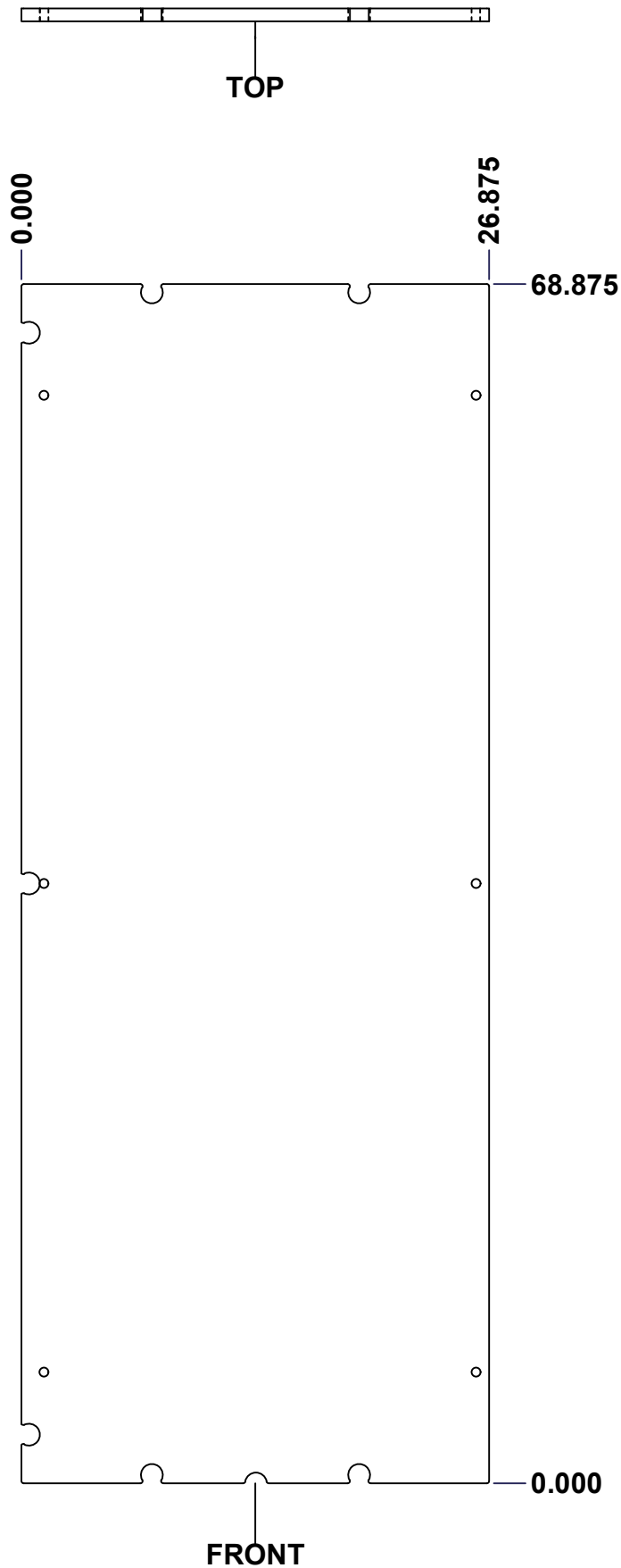

No.	Revisions	Date	By/Par

**Isometric View**

<p>Tél: (450) 979-4373 Fax: (450) 979-4626 <a href="http://www.exmweb.com">www.exmweb.com</a></p>		Flatness Aplatissement
		Max 3.0mm
		Projection
Customer Client		Date
Drawn By Dessiné Par	BoxCad: Patrick Deschenes	Date 23-Jan-07
Material Matière	Polyisocyanurate	
Color Couleur	Aluminum	Finish Fini N/A
Description		Detail Rev.
5412ESDG 72" x 30" Cover Insulation		
Part Number Numéro Pièce	Rev.	16
<b>5412ESDG723012THI-C</b>	<b>0</b>	16

**SEE BILL OF MATERIAL ON LAST PAGE**

This drawing is confidential and must not be reproduced or used without the consent of EXM

Ce dessin est confidentiel et ne doit pas être reproduit ou utilisé sans le consentement de EXM

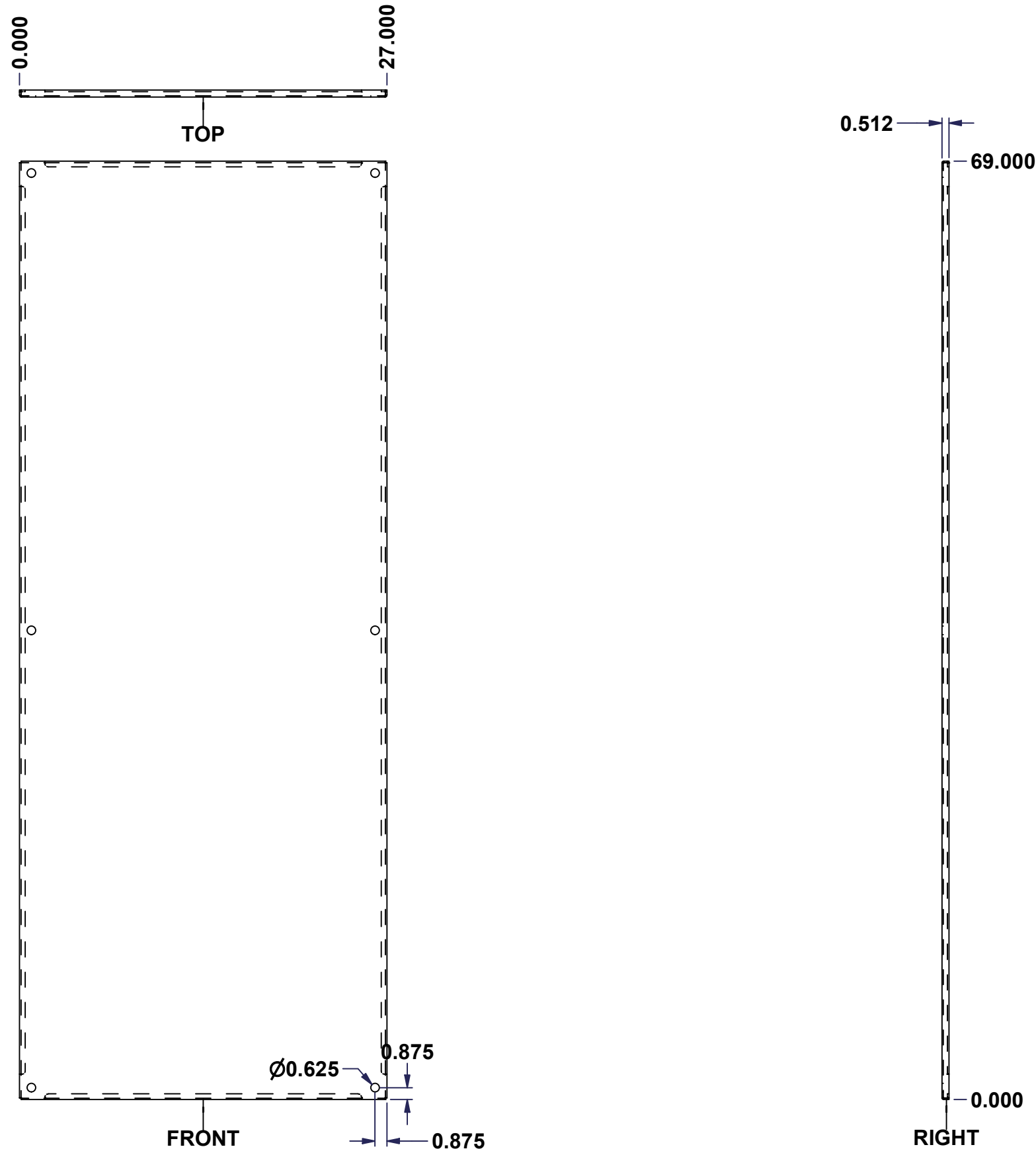

No.	Revisions	Date	By/Par

Isometric View

		Flatness Aplatissement Max 3.0mm	
Tél: (450) 979-4373 Fax: (450) 979-4626 <a href="http://www.exmweb.com">www.exmweb.com</a>		Projection 	
Customer Client		Date	
Drawn By / Dessiné Par: BoxCad: nickz		Date: 01/03/2017	
Material / Matière: 12 Ga Galvanized (2.5mm)			
Color / Couleur: See Part List		Finish / Fini: See Part List	
Description: 885SP 72" x 30" Inner Panel Part			Detail Rev.
Part Number / Numéro Pièce: <b>885SP7230G</b>			Rev. 1

Qty	Part Number	Rev	Description	Material	Color	Finish
1	885SP7230G-P	0	885SP 72" x 30" Inner Panel Part	12 Ga Galvanized (2.5mm)	Unpainted	Galvanized

Parts List