

This drawing is confidential and must not be reproduced or used without the consent of EXM

Ce dessin est confidentiel et ne doit pas être reproduit ou utilisé sans le consentement de EXM

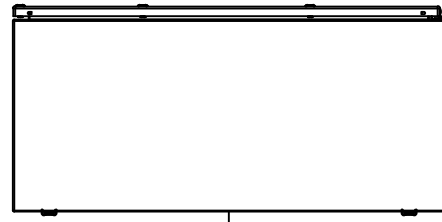

TOP

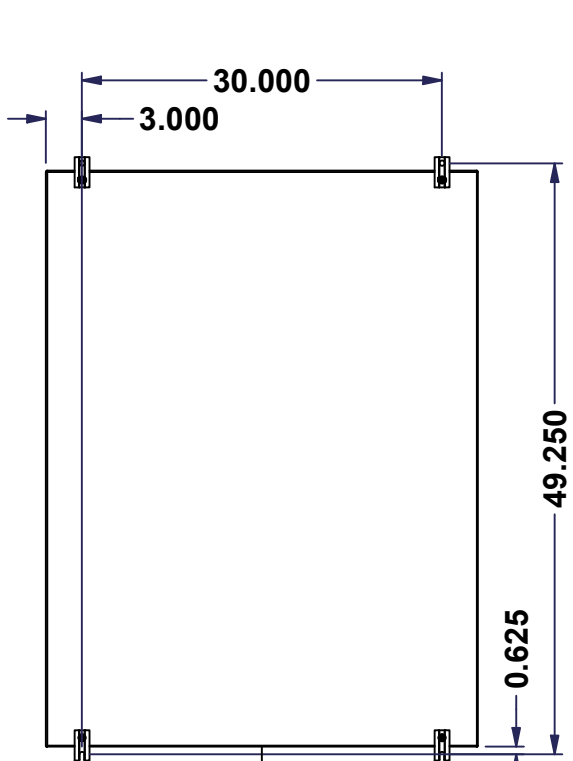

BACK

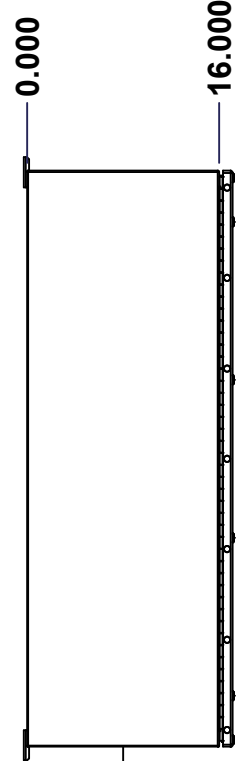

LEFT

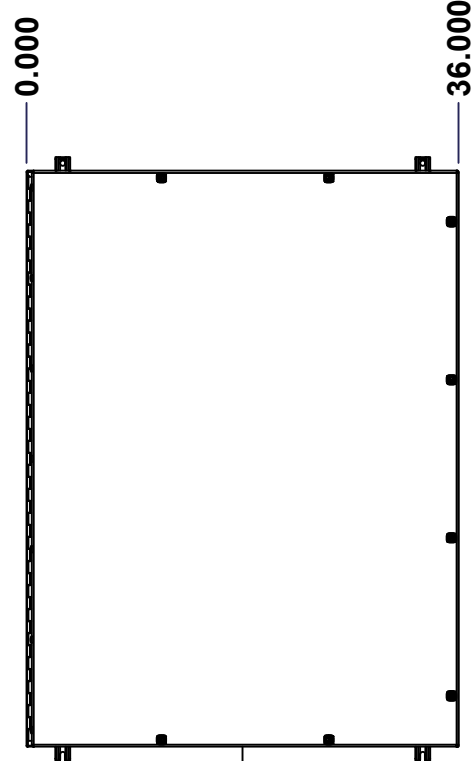

FRONT

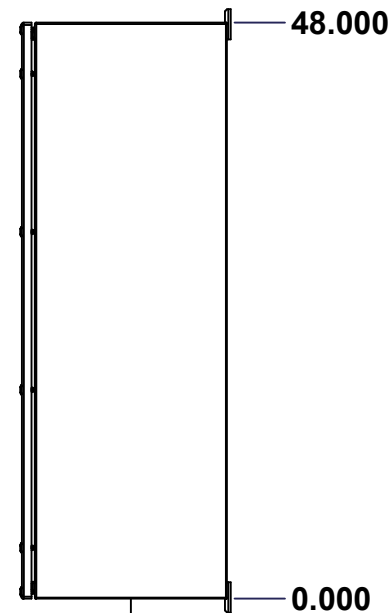

RIGHT



BOTTOM

No.	Revisions	Date	By/Par

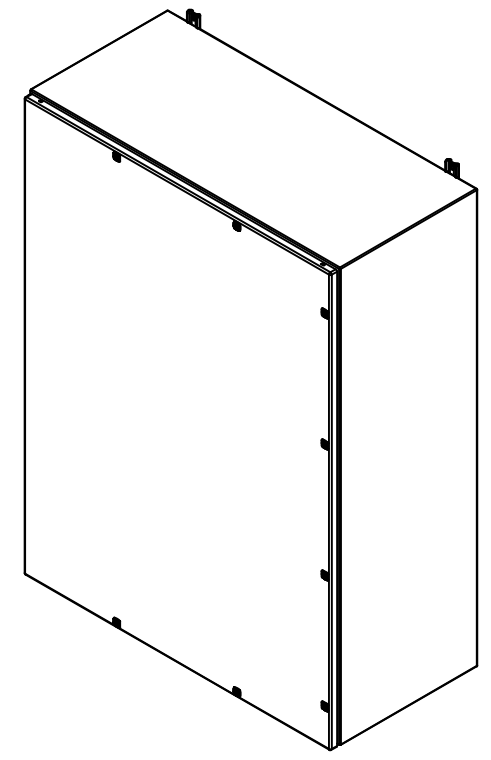

Isometric View



Tél: (450) 979-4373
 Fax: (450) 979-4626
www.exmweb.com

Flatness
Aplatissement
Max 3.0mm
Projection

Customer Client	Date
Drawn By / Dessiné Par: BoxCad: BoxCad	Date: 09-Feb-25
Material / Matière: 14 Ga Cold Rolled A1008 CS Type B (1.7mm)	

Color / Couleur: Asa-61 Grey	Finish / Fini: Smooth
------------------------------	-----------------------

Description: 5412ESEL 48" x 36" x 16" Assembly	Detail Rev.
--	-------------

Part Number / Numéro Pièce: 5412ESEL483616TH	Rev. 0	1
--	--------	---

SEE BILL OF MATERIAL ON LAST PAGE

This drawing is confidential and must not be reproduced or used without the consent of EXM

Ce dessin est confidentiel et ne doit pas être reproduit ou utilisé sans le consentement de EXM

NOTE	
ITEM	DESCRIPTION
1	NEMA 4, 12 Enclosure (IP66)
2	C/W Standard ground studs on box and cover
3	C/W Standard door stiffener
4	C/W Standard inner panel (Included)
5	C/W Standard inner panel mounting studs
6	C/W 885 ESMF3_OPEN Sold separately (Installed)
7	C/W 885 ESMF3_CLOSE Sold separately (Installed)
8	C/W R5 Insulation (Installed aluminum visible)

No.	Revisions	Date	By/Par

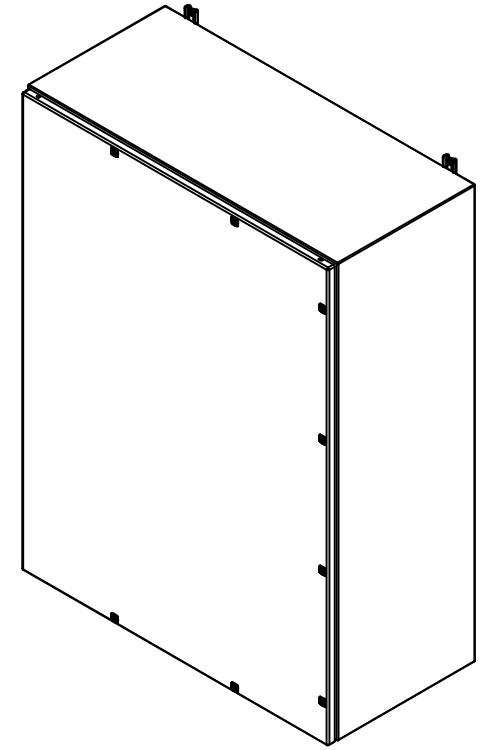

Isometric View



PACKING		
ITEM	QTY	DESCRIPTION
Cardboard sleeve	2	Top and Bottom
Cardboard strip	2	Between back of enclosure and inner panel
Plastic bag	1	To protect cover surface and inside gasket
Cardboard corner	4	To reinforced for the plastic strap tightening
Plastic strap - Black	2	To Squeeze 2 cardboard sleeve together
Packaging label	3	White label with PN
Plastic strap- Green	2	To secure the enclosure to the wood pallet
Wood Pallet	1	2" deeper and 3" larger than enclosure size

Qty	Part Number	Rev	Description
8	STK-Q-00600	2	M12 to M8 Adaptor
1	885SP4836G	0	885SP 48" x 36" Inner Panel Part
1	STK-K-01800	5	5412 ES Accessory Kit
7	RIVET_NUT_M6_FH_CE	0	Rivet Nut M6 (Low Profile Close End)
1	5412ESEL483616THC	0	5412ESEL 48" x 36" Cover
1	5412ESEL483616THB	0	5412ESEL 48" x 36" x 16" Body
7	STK-Q-04050-14	5	M6 x 14mm Hexagon Socket Head Machine Screw with Nyseal
Parts List			

<p>Tél: (450) 979-4373 Fax: (450) 979-4626 www.exmweb.com</p>	Flatness Aplatissement	Max 3.0mm
	Projection	
Customer Client	Date	
Drawn By Dessiné Par	BoxCad: BoxCad	Date 09-Feb-25
Material Matière	14 Ga Cold Rolled A1008 CS Type B (1.7mm)	
Color Couleur	Asa-61 Grey	Finish Fini Smooth
Description	Detail Rev.	
5412ESEL 48" x 36" x 16" Assembly		
Part Number Numéro Pièce	Rev. 0	2 / 16
5412ESEL483616TH		

This drawing is confidential and must not be reproduced or used without the consent of EXM

Ce dessin est confidentiel et ne doit pas être reproduit ou utilisé sans le consentement de EXM

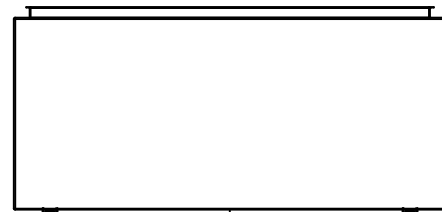

TOP



BACK

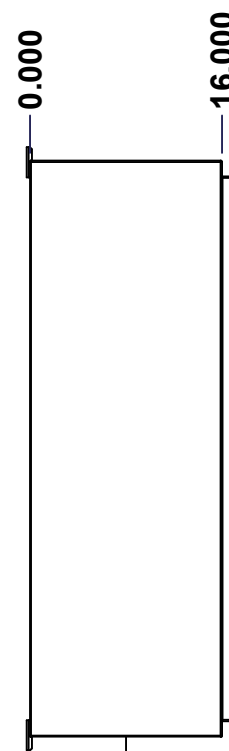

LEFT

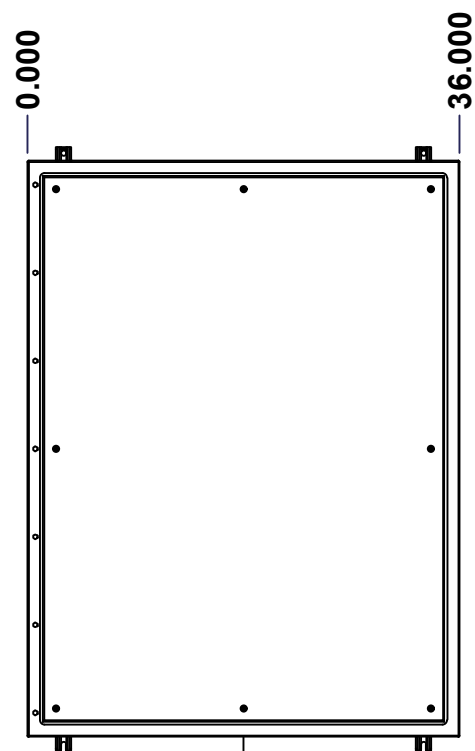

FRONT

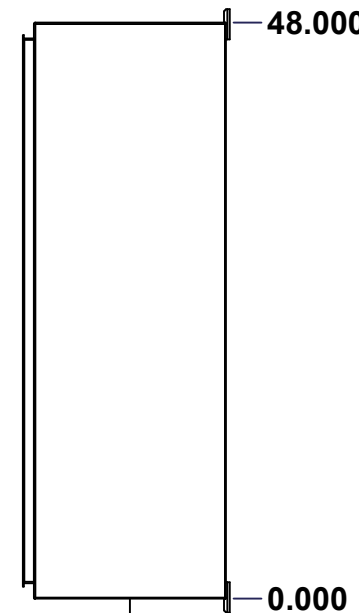

RIGHT

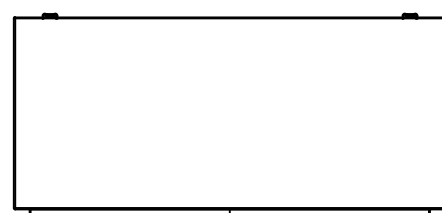

BOTTOM

No.	Revisions	Date	By/Par

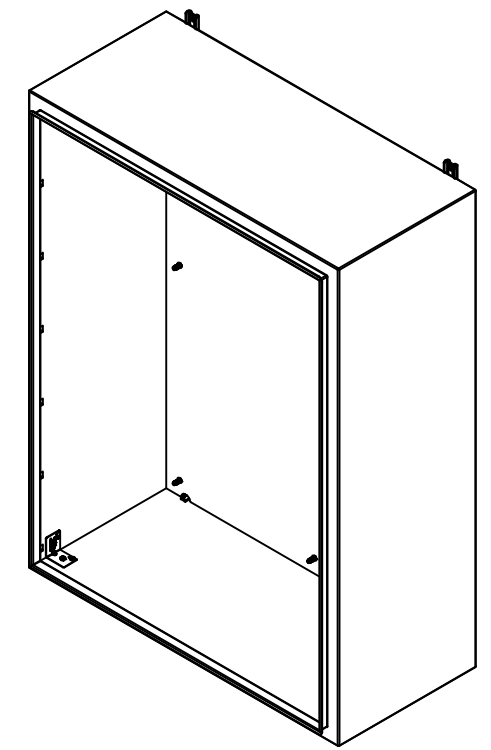

Isometric View



Tél: (450) 979-4373
 Fax: (450) 979-4626
www.exmweb.com

Flatness
Aplatissement
Max 3.0mm
Projection

Customer Client	Date
Drawn By / Dessiné Par: BoxCad: BoxCad	Date: 09-Feb-25
Material / Matière: 14 Ga Cold Rolled A1008 CS Type B (1.7mm)	

Color / Couleur: Asa-61 Grey	Finish / Fini: Smooth
------------------------------	-----------------------

Description: 5412ESEL 48" x 36" x 16" Body	Detail Rev.
--	-------------

Part Number / Numéro Pièce: 5412ESEL483616THB	Rev. 0	3
---	--------	---

SEE BILL OF MATERIAL ON LAST PAGE

This drawing is confidential and must not be reproduced or used without the consent of EXM

Ce dessin est confidentiel et ne doit pas être reproduit ou utilisé sans le consentement de EXM

STANDARD FEATURES ARE NOT LISTED IN THIS HOLE TABLE			
HOLE TABLE - TOP VIEW (CUSTOM FEATURE ONLY)			
CUT-OUT	XDIM	YDIM	DESCRIPTION
1	2.000	14.000	INSUL. STUD M6 x 18mm (Inside)
2	34.000	14.000	INSUL. STUD M6 x 18mm (Inside)

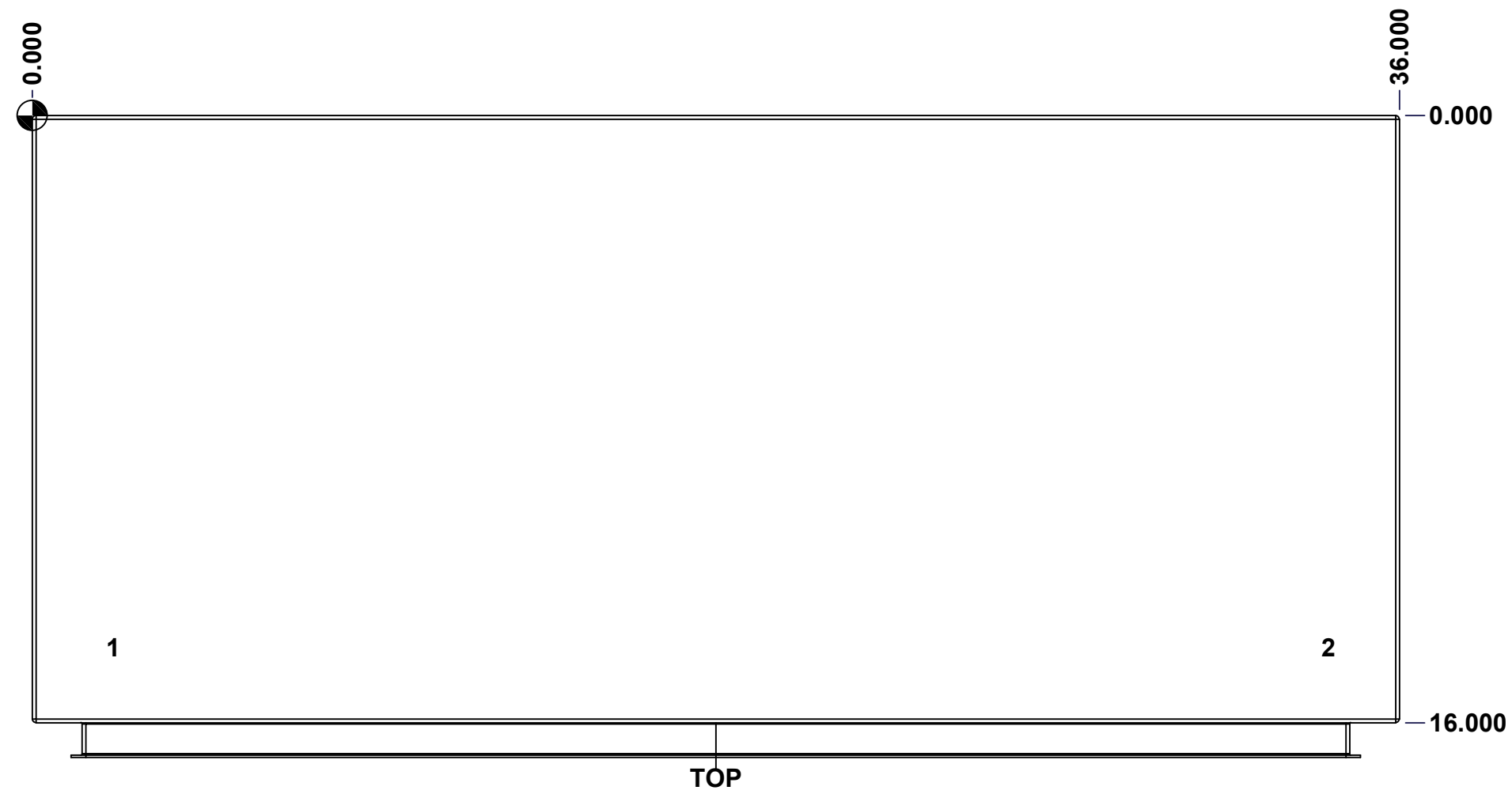

	Description	Status
	5412ESEL 48" x 36" x 16" Body	(NULL)
	Part Number Numéro Pièce	Rev.
	5412ESEL483616THB	0 / 4
		16

This drawing is confidential and must not be reproduced or used without the consent of EXM

Ce dessin est confidentiel et ne doit pas être reproduit ou utilisé sans le consentement de EXM

STANDARD FEATURES ARE NOT LISTED IN THIS HOLE TABLE			
HOLE TABLE - BOTTOM VIEW (CUSTOM FEATURE ONLY)			
CUT-OUT	XDIM	YDIM	DESCRIPTION
1	2.000	14.000	INSUL. STUD M6 x 18mm (Inside)
2	34.000	14.000	INSUL. STUD M6 x 18mm (Inside)

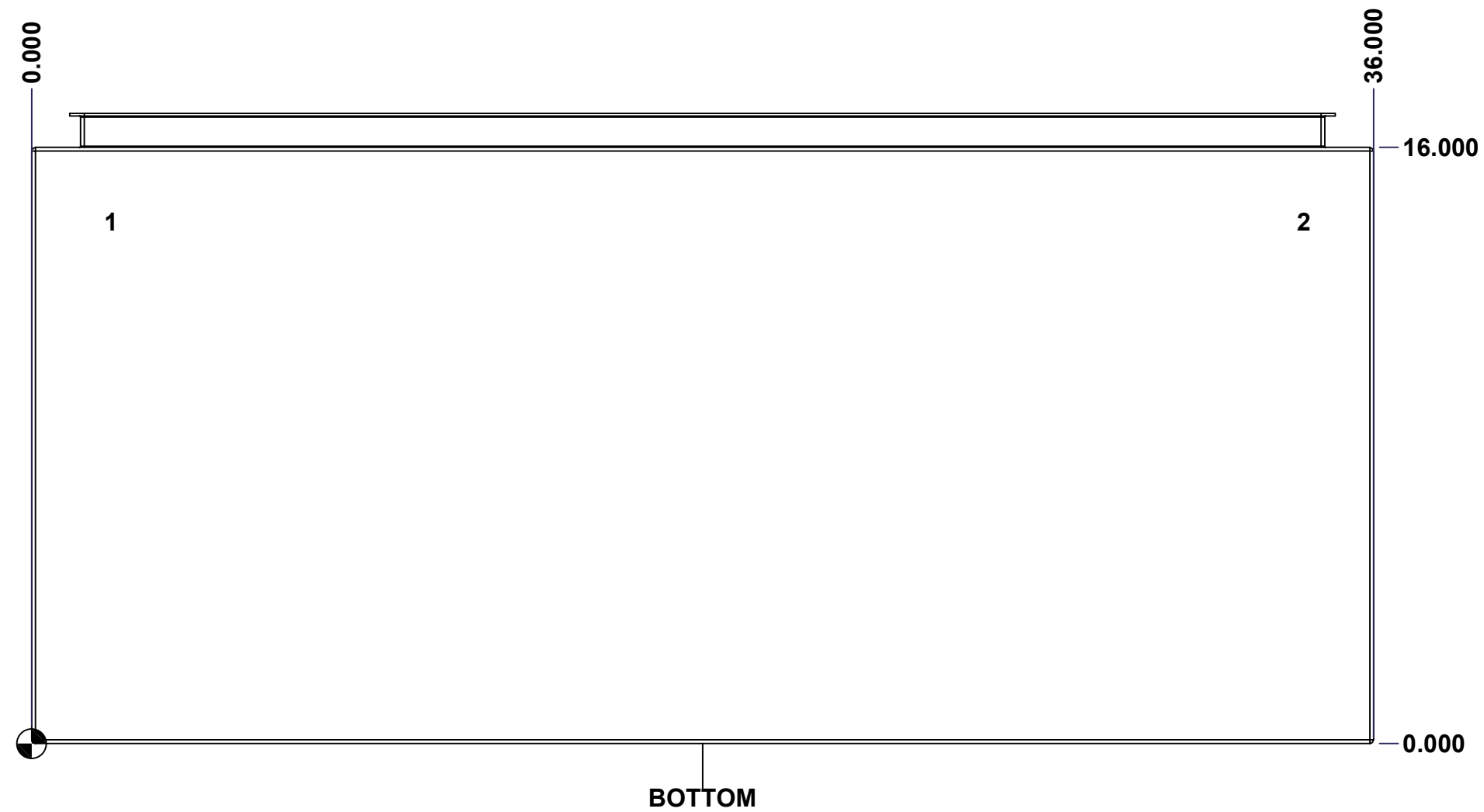

	Description	Status
	5412ESEL 48" x 36" x 16" Body	(NULL)
Part Number Numéro Pièce	5412ESEL483616THB	Rev. 5
		0
		16

This drawing is confidential and must not be reproduced or used without the consent of EXM

Ce dessin est confidentiel et ne doit pas être reproduit ou utilisé sans le consentement de EXM

STANDARD FEATURES ARE NOT LISTED IN THIS HOLE TABLE

HOLE TABLE - BACK VIEW (CUSTOM FEATURE ONLY)

CUT-OUT	XDIM	YDIM	DESCRIPTION
1	2.375	2.375	IP STUD M8 x 35mm (Inside)
2	2.375	45.625	IP STUD M8 x 35mm (Inside)
3	33.625	45.625	IP STUD M8 x 35mm (Inside)
4	33.625	2.375	IP STUD M8 x 35mm (Inside)
5	2.375	24.000	IP STUD M8 x 35mm (Inside)
6	33.625	24.000	IP STUD M8 x 35mm (Inside)
7	18.000	2.375	IP STUD M8 x 35mm (Inside)
8	18.000	45.625	IP STUD M8 x 35mm (Inside)

9	3.000	0.000	FOOT 885 ESMF3_OPEN
10	33.000	48.000	FOOT 885 ESMF3_CLOSE
11	3.000	48.000	FOOT 885 ESMF3_CLOSE
12	33.000	0.000	FOOT 885 ESMF3_OPEN

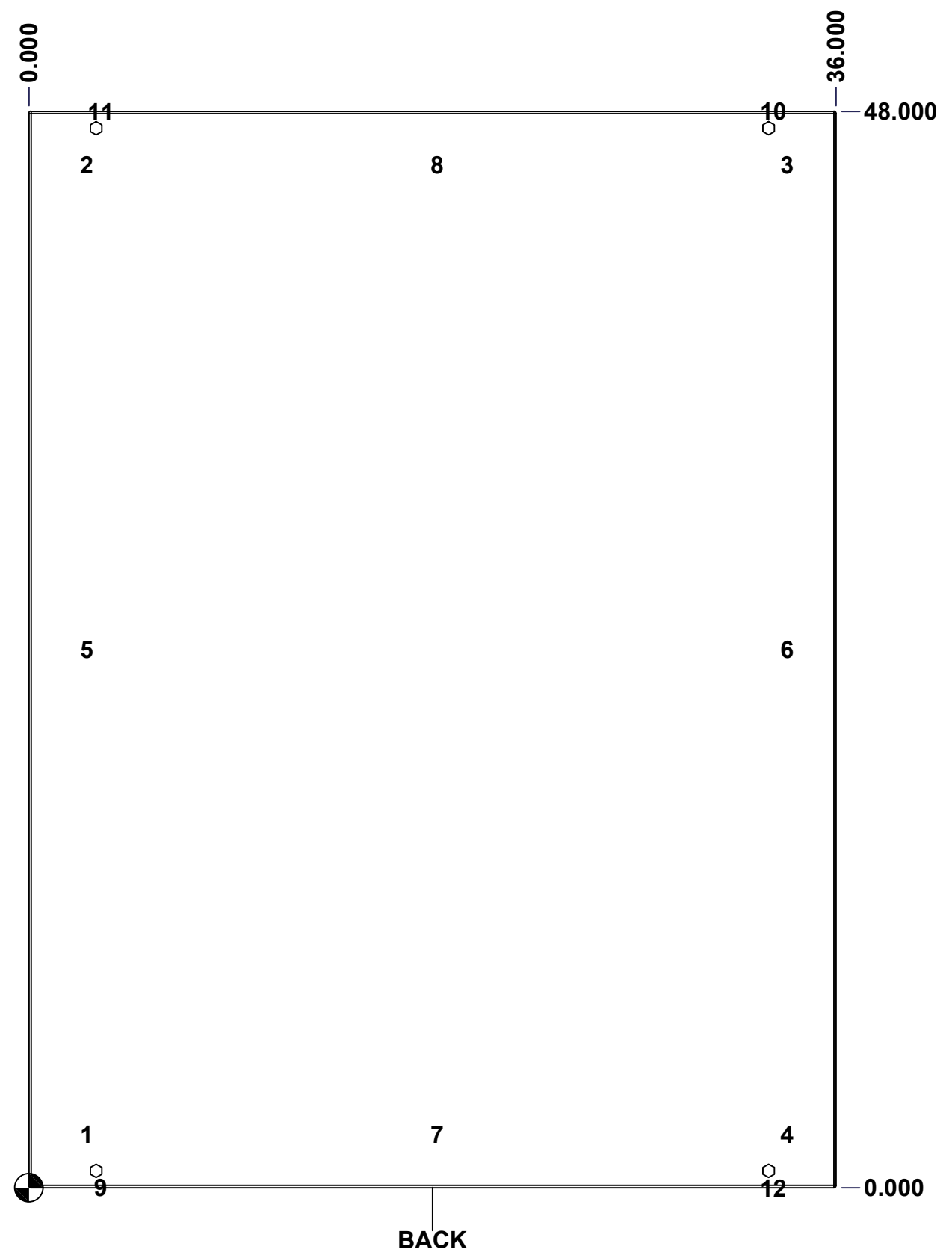

	Description	Status
	5412ESEL 48" x 36" x 16" Body	(NULL)
	Part Number Numéro Pièce	Rev.
	5412ESEL483616THB	0 / 6
		16

This drawing is confidential and must not be reproduced or used without the consent of EXM

Ce dessin est confidentiel et ne doit pas être reproduit ou utilisé sans le consentement de EXM

No.	Revisions	Date	By/Par

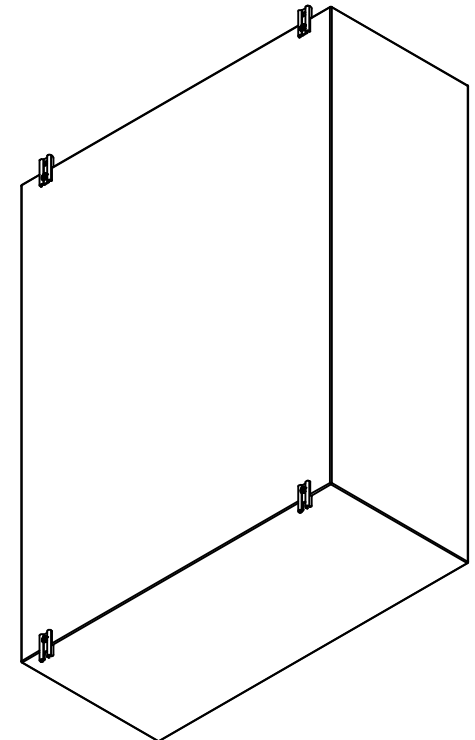

Isometric View



1	885 ESMF3	0	885 ESMF3 Mounting Foot Kit
4	RIVET_NUT_M10_FH_CE	0	Rivet Nut M10 (Low Profile Close End)
1	STK-K-70554	3	5412 ESTH Accessory Kit
1	5412ESEL483616THI-RS	0	5412ESEL 48" x 36" Right Insulation
1	5412ESEL483616THI-LS	0	5412ESEL 48" x 36" Left Insulation
1	5412ESEL483616THI-BT	0	5412ESEL 48" x 36"Bottom Insulation
1	5412ESEL483616THI-TP	0	5412ESEL 48" x 36"Top Insulation
1	5412ESEL483616THI-B	0	5412ESEL 48" x 36" Back Insulation
4	STK-Q-16055	1	M6 x 18mm Stud (No Paint Cap Required)
1	STK-P-02400S	0	Powder Paint (Asa-61 Grey / Smooth)
8	STK-Q-16005	0	Stud M8 x 35mm Steel
1	5412ESEL483616THB-P	0	5412ESEL 48" x 36" x 16" Body Part

Qty	Part Number	Rev	Description
Parts List			

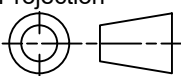
 Tél: (450) 979-4373 Fax: (450) 979-4626 www.exmweb.com		Flatness Aplatissement Max 3.0mm
Projection 		Customer Client
Drawn By Dessiné Par BoxCad: BoxCad		Date 09-Feb-25
Material Matière 14 Ga Cold Rolled A1008 CS Type B (1.7mm)		
Color Couleur Asa-61 Grey	Finish Fini Smooth	
Description 5412ESEL 48" x 36" x 16" Body		Detail Rev.
Part Number Numéro Pièce 5412ESEL483616THB		Rev. 7 0

This drawing is confidential and must not be reproduced or used without the consent of EXM

Ce dessin est confidentiel et ne doit pas être reproduit ou utilisé sans le consentement de EXM

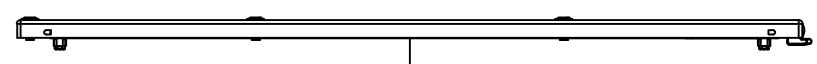

TOP

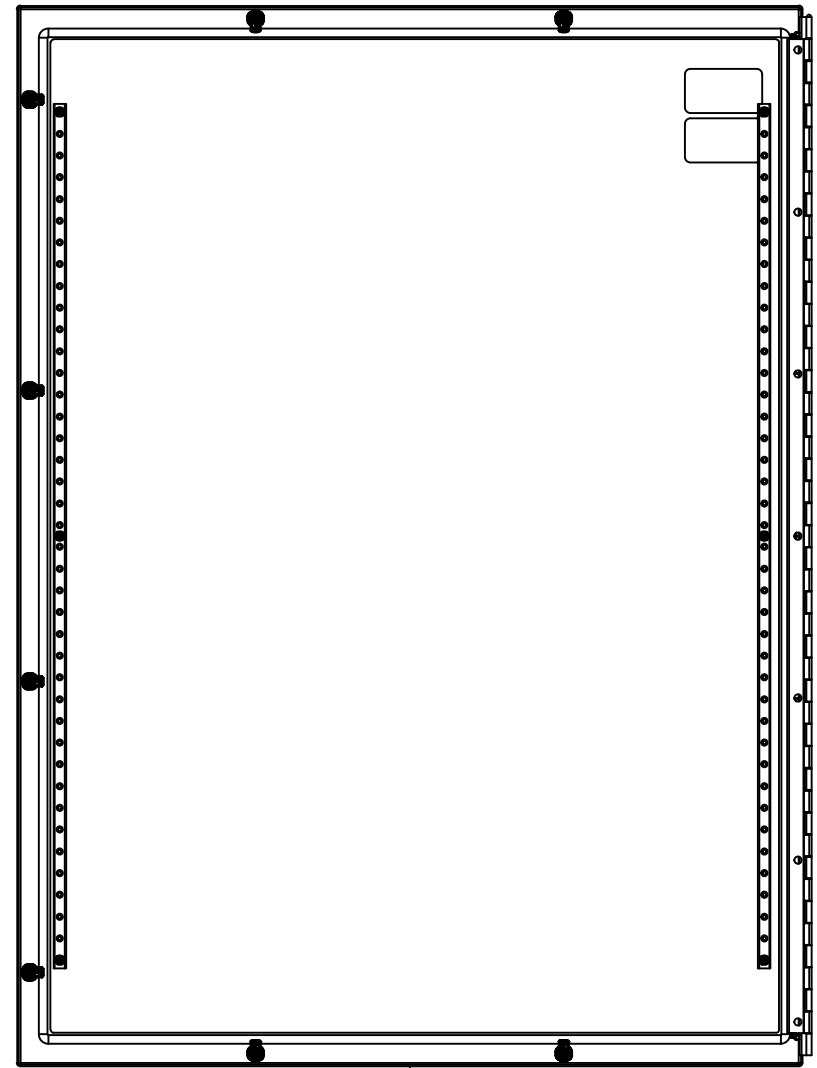

BACK

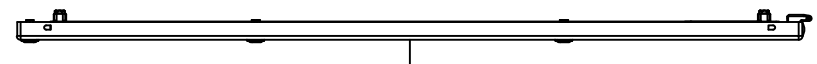

BOTTOM

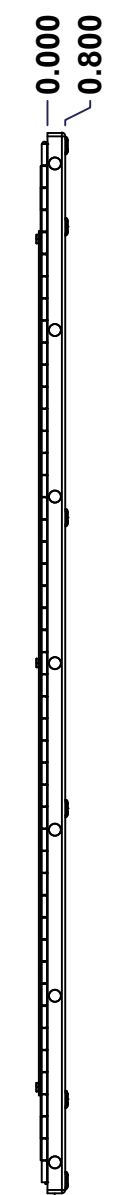

LEFT

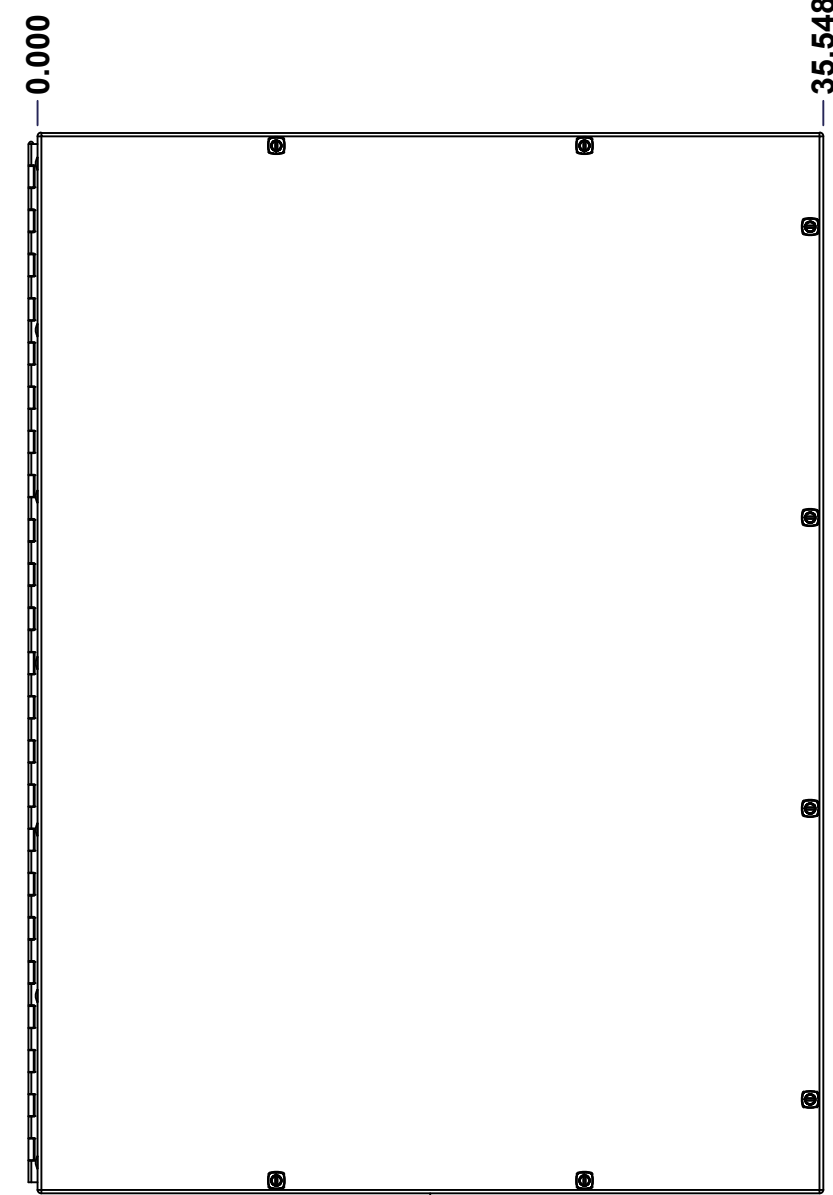

FRONT

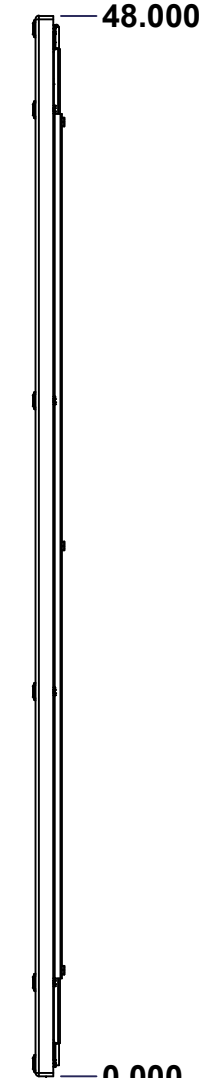

RIGHT

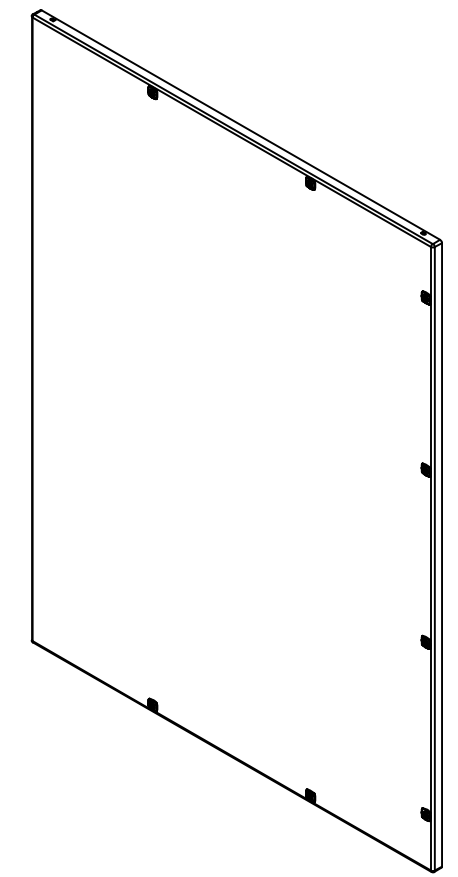

Isometric View

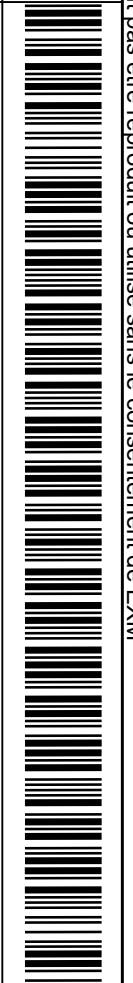

No.	Revisions	Date	By/Par

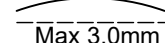
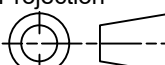
 Tél: (450) 979-4373 Fax: (450) 979-4626 www.exmweb.com		Flatness Aplatissement  Max 3.0mm Projection 
Customer Client	Date	
Drawn By Dessiné Par	BoxCad: BoxCad	Date 09-Feb-25
Material Matière	14 Ga Cold Rolled A1008 CS Type B (1.7mm)	
Color Couleur	Asa-61 Grey	Finish Fini Smooth
Description 5412ESEL 48" x 36" Cover		Detail Rev.
Part Number Numéro Pièce	Rev. 0	8 / 16

SEE BILL OF MATERIAL ON LAST PAGE

5412ESEL483616THC

This drawing is confidential and must not be reproduced or used without the consent of EXM

Ce dessin est confidentiel et ne doit pas être reproduit ou utilisé sans le consentement de EXM

STANDARD FEATURES ARE NOT LISTED IN THIS HOLE TABLE

HOLE TABLE - FRONT VIEW (CUSTOM FEATURE ONLY)

CUT-OUT	XDIM	YDIM	DESCRIPTION
1	1.729	4.807	STUD M6 x 18mm (Inside)
2	1.729	43.193	STUD M6 x 18mm (Inside)
3	1.729	24.000	STUD M6 x 18mm (Inside)
4	33.609	4.807	STUD M6 x 18mm (Inside)
5	33.609	43.193	STUD M6 x 18mm (Inside)
6	33.609	24.000	STUD M6 x 18mm (Inside)

7	34.968	43.750	LOCK 880 SCQ5-SL @ 180.0°
8	34.968	17.417	LOCK 880 SCQ5-SL @ 180.0°
9	34.968	30.583	LOCK 880 SCQ5-SL @ 180.0°
10	10.800	47.420	LOCK 880 SCQ5-SL @ 270.0°
11	24.748	47.420	LOCK 880 SCQ5-SL @ 270.0°
12	10.800	0.580	LOCK 880 SCQ5-SL @ 90.0°
13	24.748	0.580	LOCK 880 SCQ5-SL @ 90.0°
14	34.968	4.250	LOCK 880 SCQ5-SL @ 180.0°

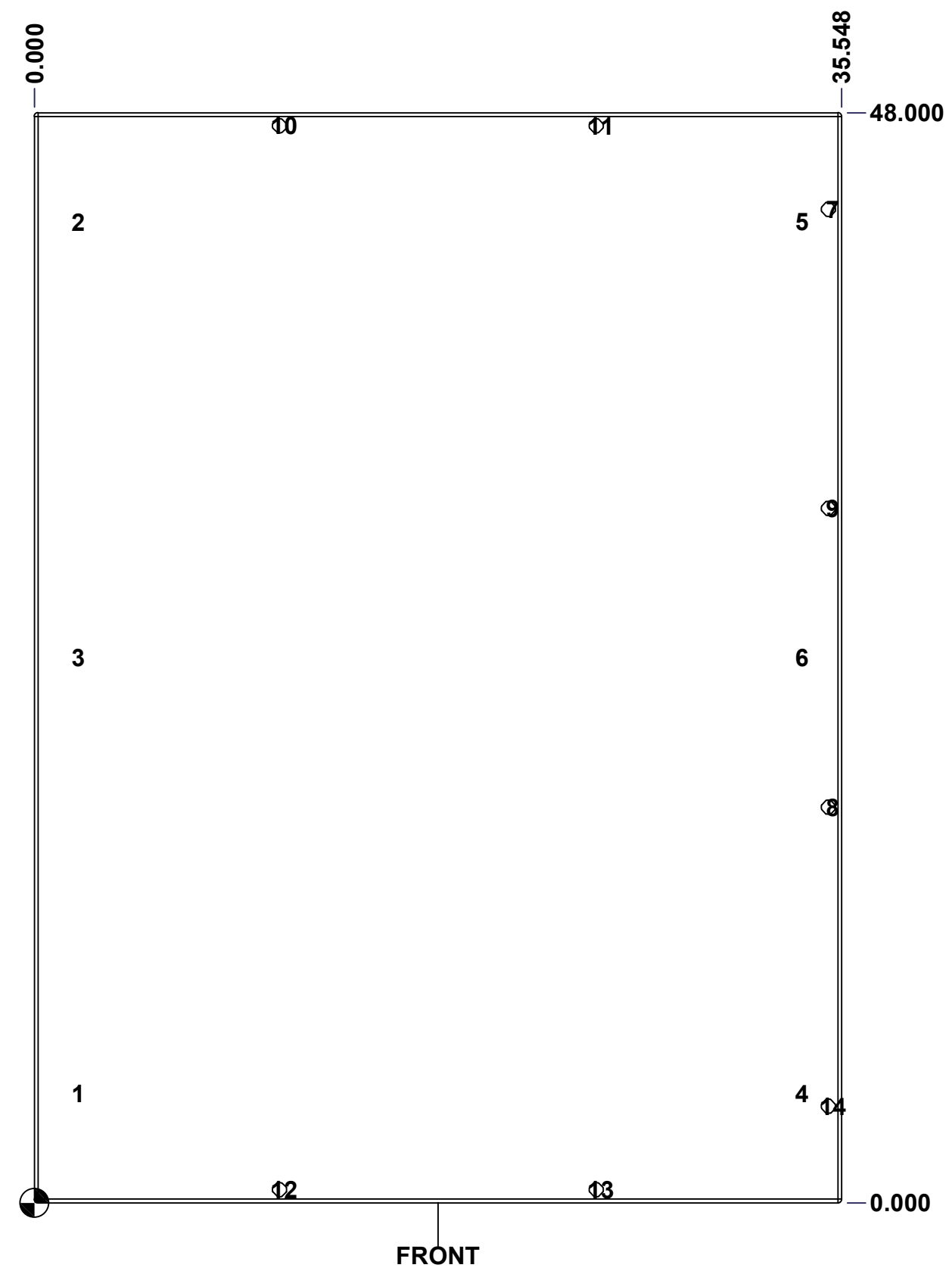

	Description	Status
	5412ESEL 48" x 36" Cover	(NULL)
	Part Number	Rev.
	Numéro Pièce 5412ESEL483616THC	0 / 9
		16

This drawing is confidential and must not be reproduced or used without the consent of EXM

Ce dessin est confidentiel et ne doit pas être reproduit ou utilisé sans le consentement de EXM

No.	Revisions	Date	By/Par

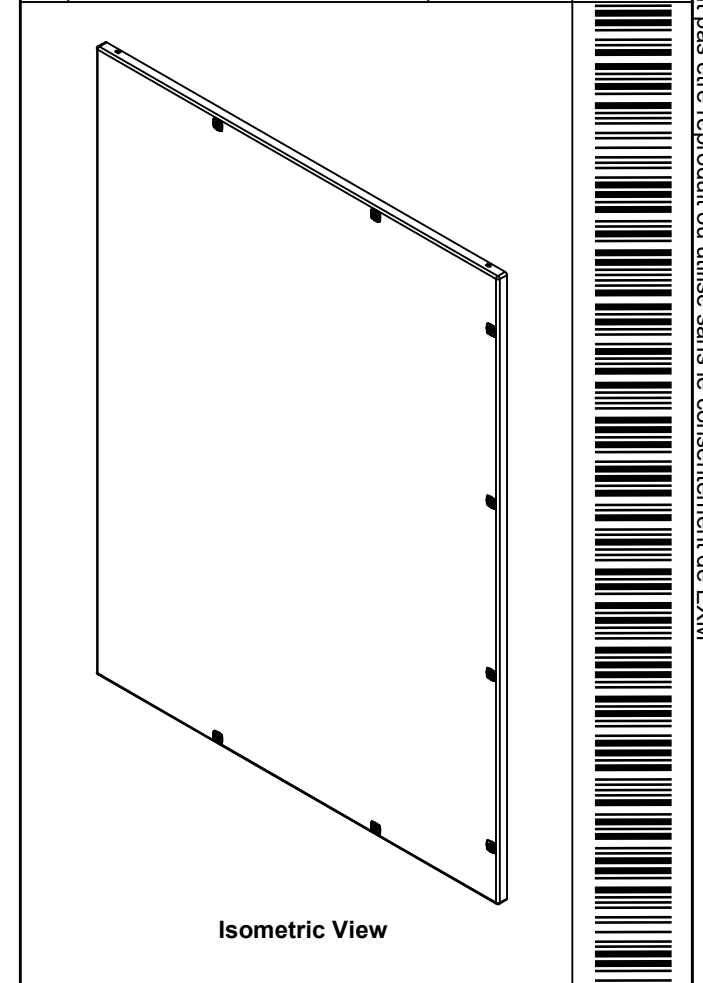

2	STK-S-00100	0	3.5" x 2" Silver Milar Flexcon Sticker
6	STK-Q-07250	2	M6 x 16mm Collar Nut
2	STK-Q-46020-42	6	5412 ES Vertical Door Stiffener 42"
1	5412ESEL483616THI-C	0	5412ESEL 48" x 36" Cover Insulation
1	STK-P-02400S	0	Powder Paint (Asa-61 Grey / Smooth)
6	STK-Q-16055	1	M6 x 18mm Stud (No Paint Cap Required)
7	STK-Q-00260	1	M6 x 13mm Carriage Bolt
1	5412ESEL483616THHP-P	0	Piano Hinge Pin (Length= 47.181")
1	5412ESEL483616THH1-P	0	5412ESEL 48" x 36" Piano Hinge Part
1	5412ESEL483616THH2-P	0	5412ESEL 48" x 36" Piano Hinge Part
1	5412ESEL483616THG	0	5412ESEL 48" x 36" Cover Gasket Part
1	5412ESEL483616THC-P	0	5412ESEL 48" x 36" Cover Part
8	880 SCQ5-SL		5412 ESEL 1/4 Turn Lock
7	STK-Q-07225	0	M6 Stainless Steel Nylon Insert Lock Nut
QTY	Part Number	Rev	Description
Parts List			

Tél: (450) 979-4373 Fax: (450) 979-4626 www.exmweb.com	Flatness Aplatissement	Max 3.0mm
	Projection	
Customer Client	Date	
Drawn By Dessiné Par	BoxCad: BoxCad	Date 09-Feb-25
Material Matière	14 Ga Cold Rolled A1008 CS Type B (1.7mm)	
Color Couleur	Asa-61 Grey	Finish Fini Smooth
Description	Detail Rev.	
5412ESEL 48" x 36" Cover		
Part Number Numéro Pièce	Rev. 0	10 / 16
5412ESEL483616THC		

This drawing is confidential and must not be reproduced or used without the consent of EXM

Ce dessin est confidentiel et ne doit pas être reproduit ou utilisé sans le consentement de EXM

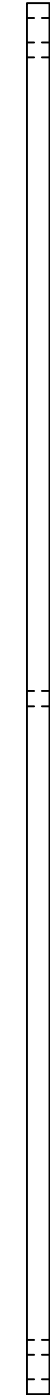
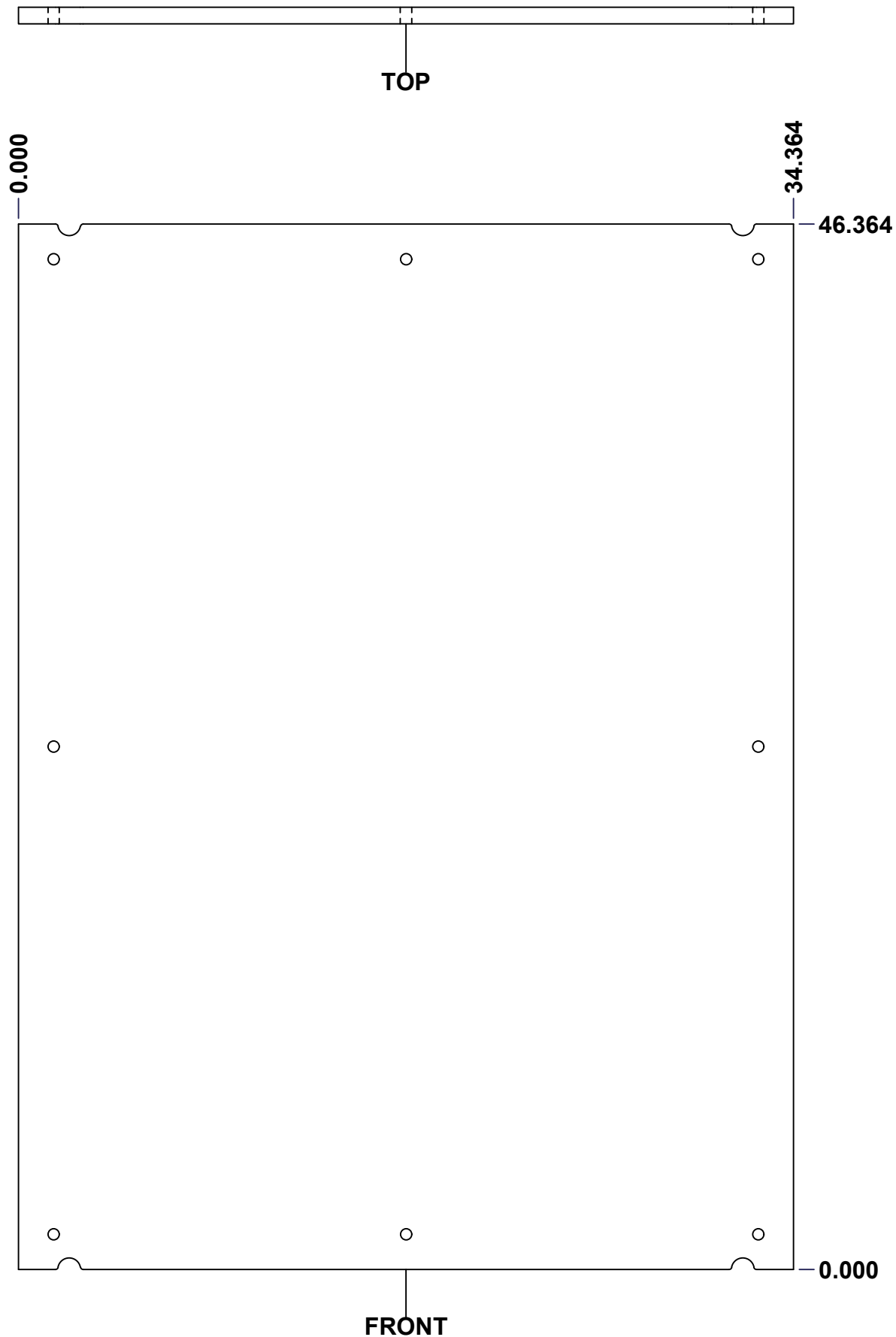

No.	Revisions	Date	By/Par

Isometric View

<p>Tél: (450) 979-4373 Fax: (450) 979-4626 www.exmweb.com</p>		Flatness Aplatissement
		Max 3.0mm
Projection		
Customer Client	Date	
Drawn By Dessiné Par	BoxCad: Patrick Deschenes	Date 23-Jan-07
Material Matière	Polyisocyanurate	
Color Couleur	Aluminum	Finish Fini N/A
Description		Detail Rev.
5412ESEL 48" x 36" Back Insulation		
Part Number Numéro Pièce	Rev.	11
5412ESEL483616THI-B	0	16

SEE BILL OF MATERIAL ON LAST PAGE

This drawing is confidential and must not be reproduced or used without the consent of EXM

Ce dessin est confidentiel et ne doit pas être reproduit ou utilisé sans le consentement de EXM

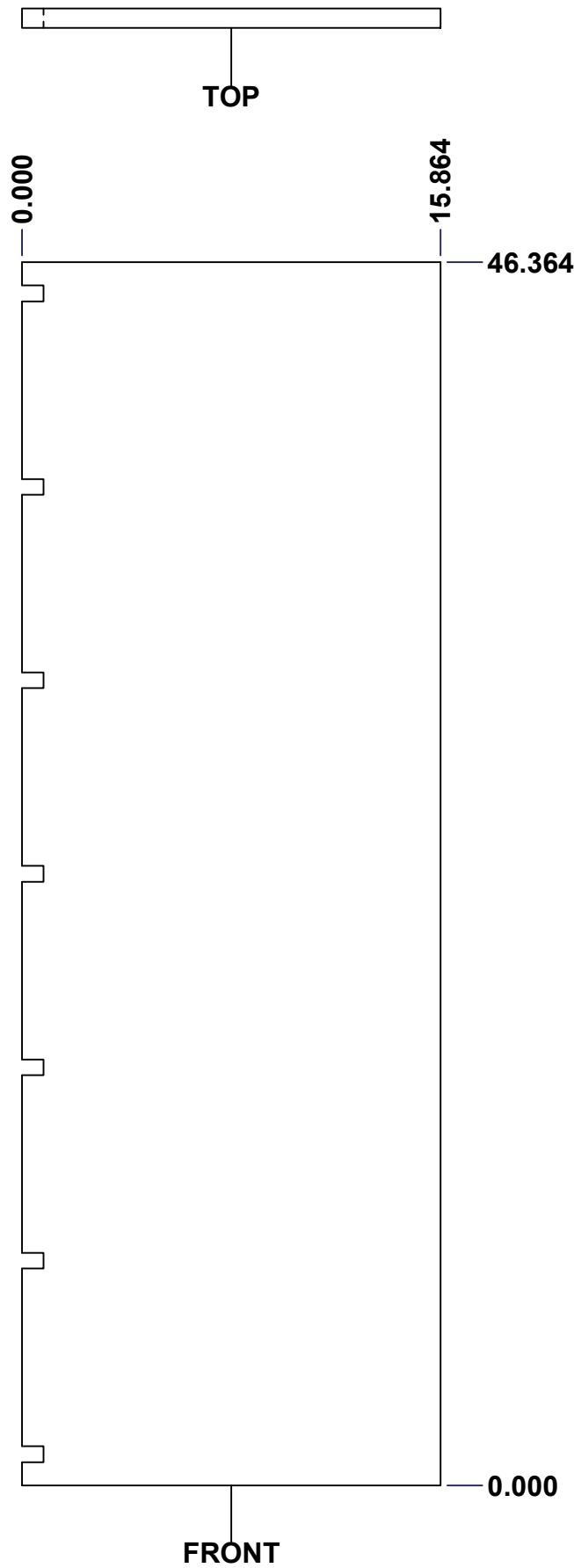

No.	Revisions	Date	By/Par

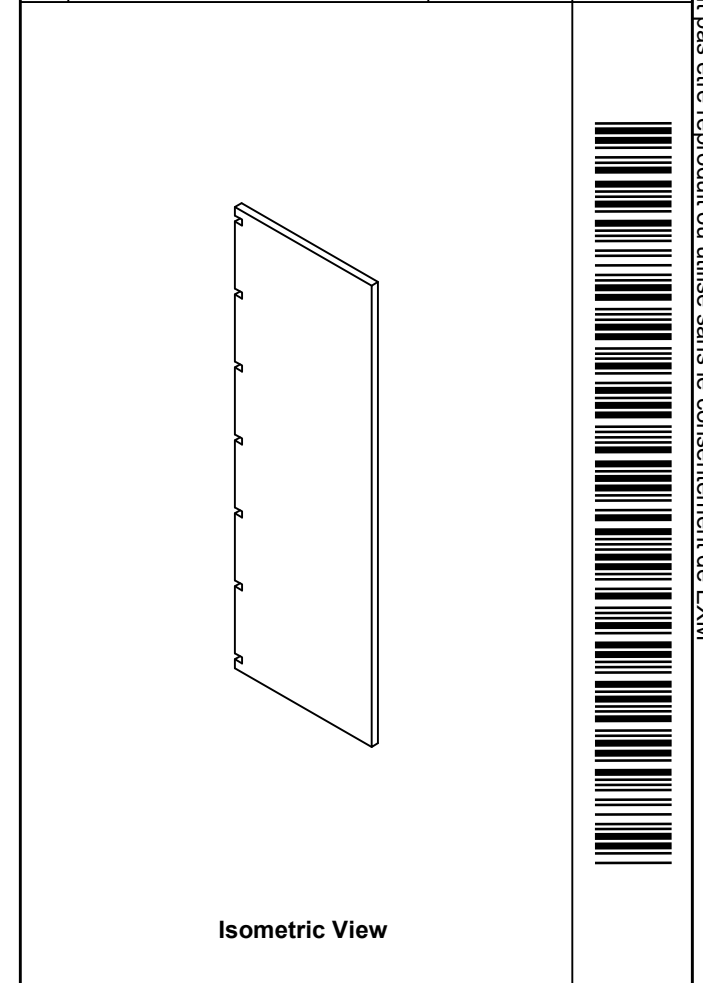

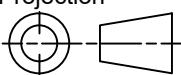
 Tél: (450) 979-4373 Fax: (450) 979-4626 www.exmweb.com		Flatness Aplatissement Max 3.0mm
Customer Client		Projection 
Drawn By / Dessiné Par: BoxCad: Patrick Deschenes		Date: 23-Jan-07
Material / Matière: Polyisocyanurate		
Color / Couleur: Aluminum	Finish / Fini: N/A	
Description: 5412ESEL 48" x 36" Left Insulation		Detail Rev.
Part Number / Numéro Pièce: 5412ESEL483616THI-LS		Rev. 12 / 16

SEE BILL OF MATERIAL ON LAST PAGE

This drawing is confidential and must not be reproduced or used without the consent of EXM

Ce dessin est confidentiel et ne doit pas être reproduit ou utilisé sans le consentement de EXM

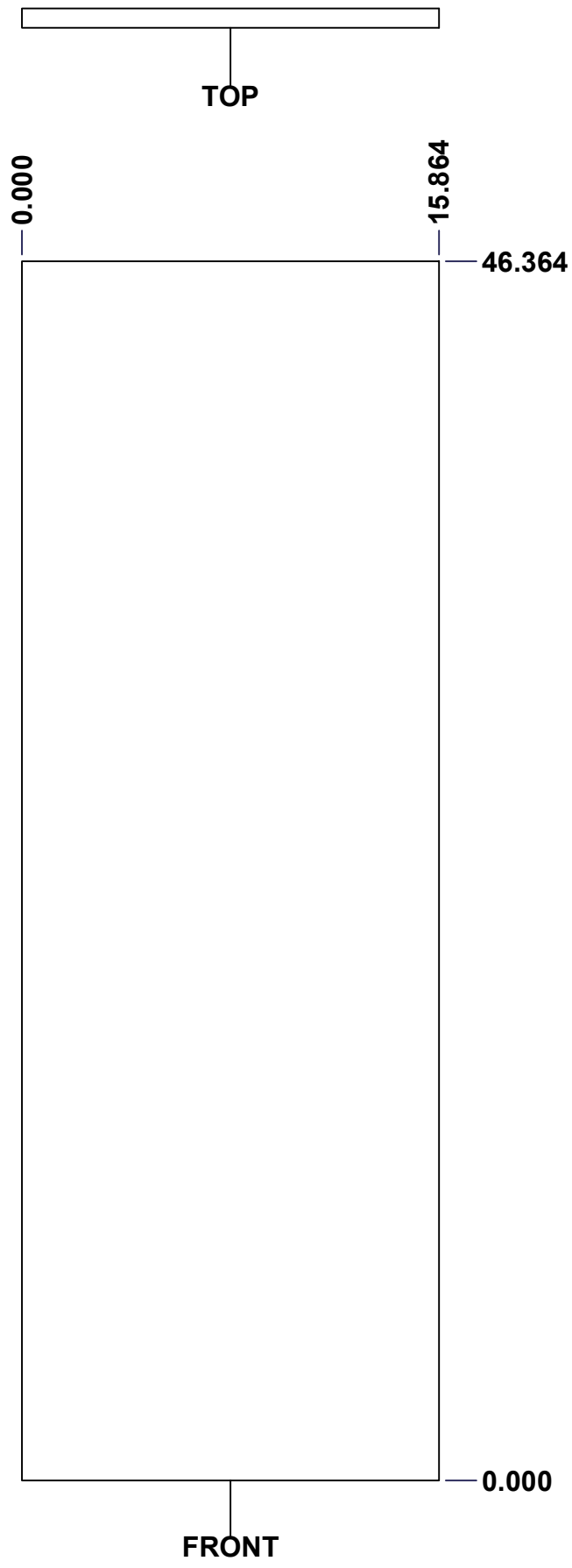

No.	Revisions	Date	By/Par

Isometric View

Tél: (450) 979-4373 Fax: (450) 979-4626 www.exmweb.com		Flatness Aplatissement Max 3.0mm
Customer Client		Projection
Drawn By / Dessiné Par: BoxCad: Patrick Deschenes		Date: 23-Jan-07
Material / Matière: Polyisocyanurate		
Color / Couleur: Aluminum	Finish / Fini: N/A	
Description: 5412ESEL 48" x 36" Right Insulation		Detail Rev.
Part Number / Numéro Pièce: 5412ESEL483616THI-RS		Rev. 13 0 16

SEE BILL OF MATERIAL ON LAST PAGE

This drawing is confidential and must not be reproduced or used without the consent of EXM

Ce dessin est confidentiel et ne doit pas être reproduit ou utilisé sans le consentement de EXM

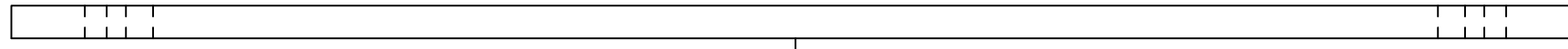

TOP



FRONT

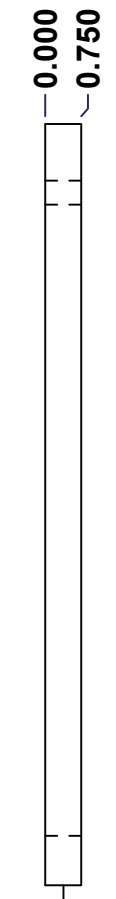

RIGHT

No.	Revisions	Date	By/Par

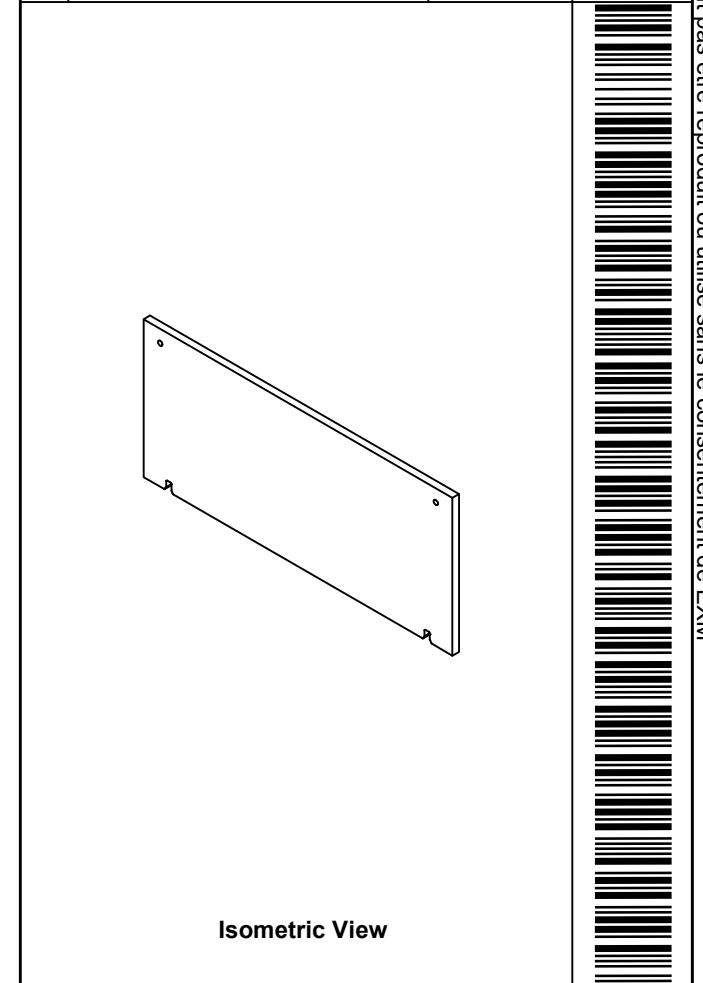

Isometric View



Tél: (450) 979-4373
 Fax: (450) 979-4626
www.exmweb.com

Flatness
Aplatissement
Max 3.0mm
Projection

Customer Client	Date
Drawn By Dessiné Par BoxCad: BoxCad	Date 4/3/2024
Material Matière Polyisocyanurate	
Color Couleur Aluminum	Finish Fini Smooth
Description 5412ESEL 48" x 36"Top Insulation	Detail Rev.
Part Number Numéro Pièce 5412ESEL483616THI-TP	Rev. 0

SEE BILL OF MATERIAL ON LAST PAGE

This drawing is confidential and must not be reproduced or used without the consent of EXM

Ce dessin est confidentiel et ne doit pas être reproduit ou utilisé sans le consentement de EXM

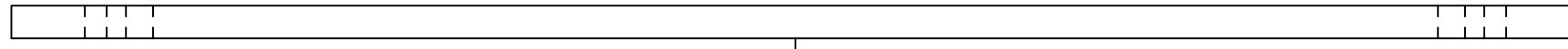

TOP



FRONT

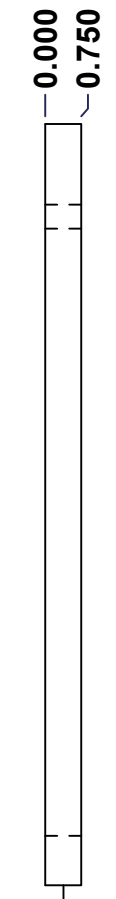

RIGHT

No.	Revisions	Date	By/Par

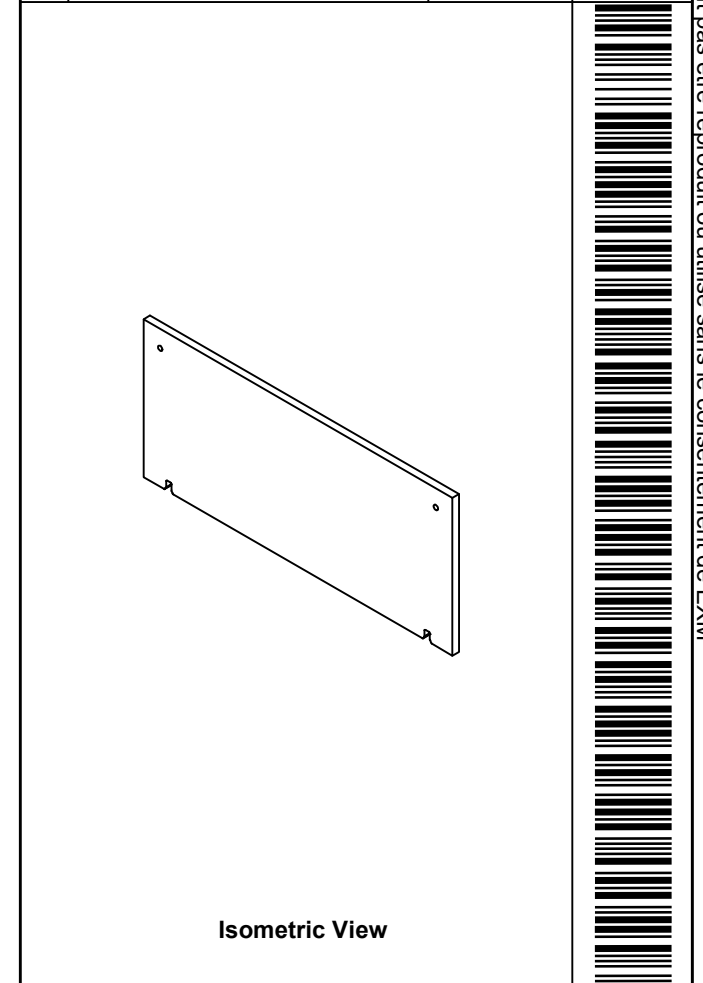

Isometric View

EXM
exm

Tél: (450) 979-4373
Fax: (450) 979-4626
www.exmweb.com

Flatness
Aplatissement
Max 3.0mm

Projection

Customer Client	Date
Drawn By Dessiné Par BoxCad: BoxCad	Date 4/3/2024
Material Matière Polyisocyanurate	
Color Couleur Aluminum	Finish Fini Smooth
Description 5412ESEL 48" x 36"Bottom Insulation	Detail Rev.
Part Number Numéro Pièce 5412ESEL483616THI-BT	Rev. 15 0

SEE BILL OF MATERIAL ON LAST PAGE

This drawing is confidential and must not be reproduced or used without the consent of EXM

Ce dessin est confidentiel et ne doit pas être reproduit ou utilisé sans le consentement de EXM

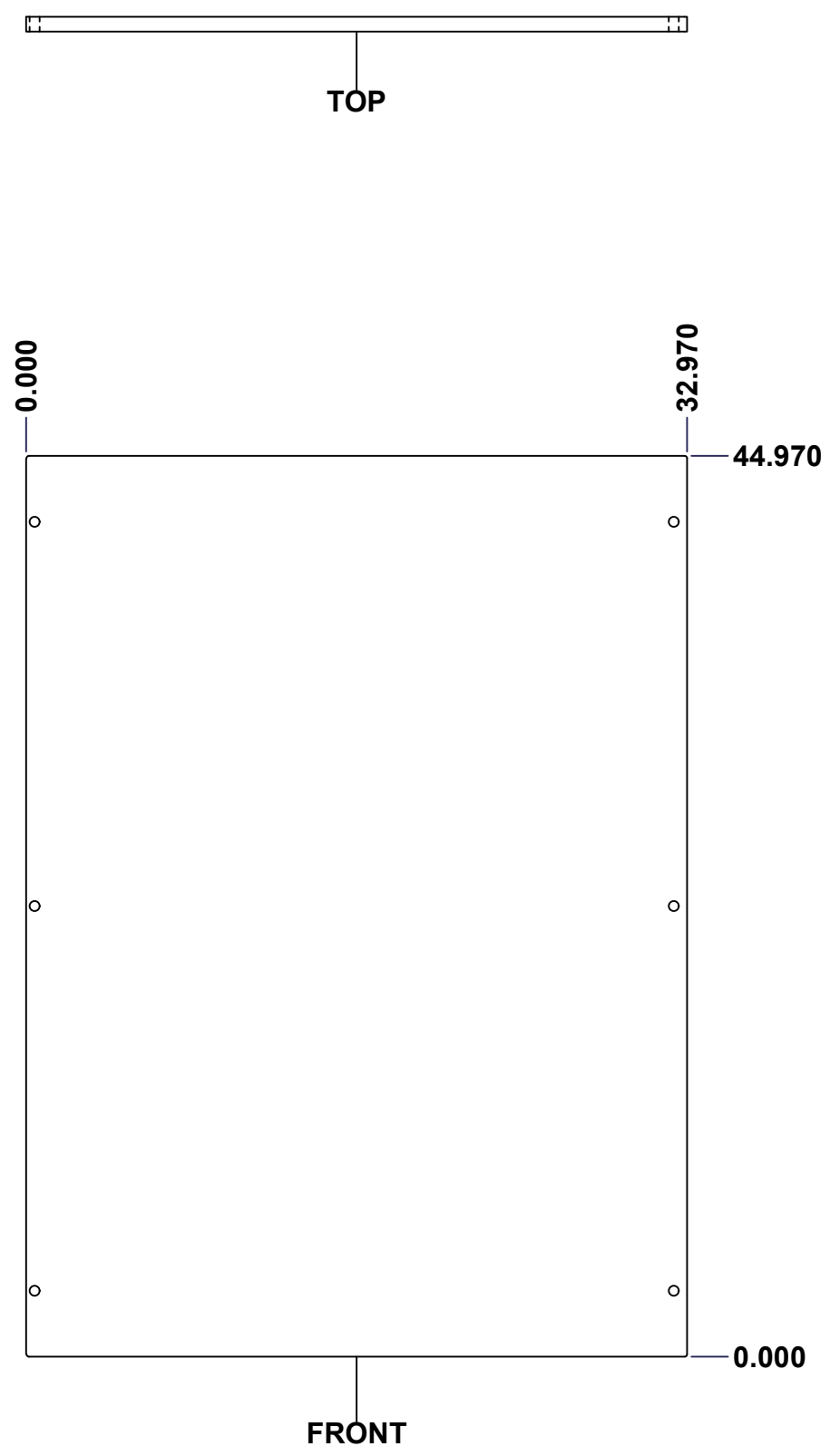

No.	Revisions	Date	By/Par

Isometric View

Tél: (450) 979-4373 Fax: (450) 979-4626 www.exmweb.com		Flatness Aplatissement
		Max 3.0mm
Customer Client		Projection
Drawn By / Dessiné Par: BoxCad: Patrick Deschenes		Date: 23-Jan-07
Material / Matière: Polyisocyanurate		
Color / Couleur: Aluminum	Finish / Fini: N/A	
Description: 5412ESEL 48" x 36" Cover Insulation		Detail Rev.
Part Number / Numéro Pièce: 5412ESEL483616THI-C		Rev. 0 / 16

SEE BILL OF MATERIAL ON LAST PAGE

This drawing is confidential and must not be reproduced or used without the consent of EXM

Ce dessin est confidentiel et ne doit pas être reproduit ou utilisé sans le consentement de EXM

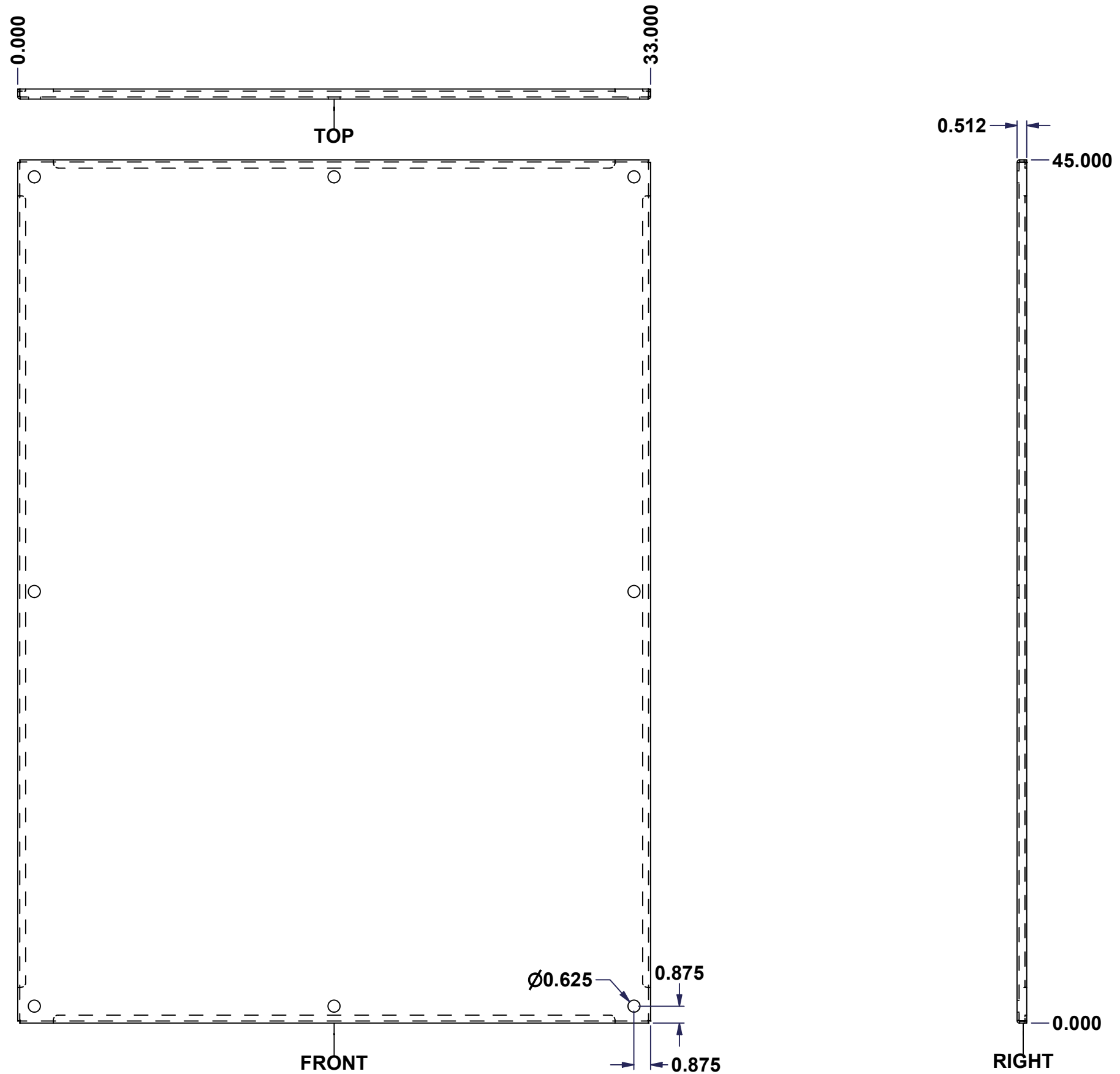

No.	Revisions	Date	By/Par

Isometric View

Tél: (450) 979-4373 Fax: (450) 979-4626 www.exmweb.com		Flatness Aplatissement
		Max 3.0mm
Projection		Date
Customer Client	BoxCad: nickz	Date 01/03/2017
Material Matière	12 Ga Galvanized (2.5mm)	
Color Couleur	See Part List	Finish Fini See Part List
Description		Detail Rev.
885SP 48" x 36" Inner Panel Part		
Part Number Numéro Pièce	885SP4836G	Rev. 1
		0

Qty	Part Number	Rev	Description	Material	Color	Finish
1	885SP4836G-P	0	885SP 48" x 36" Inner Panel Part	12 Ga Galvanized (2.5mm)	Unpainted	Galvanized

Parts List