

This drawing is confidential and must not be reproduced or used without the consent of EXM

Ce dessin est confidentiel et ne doit pas être reproduit ou utilisé sans le consentement de EXM

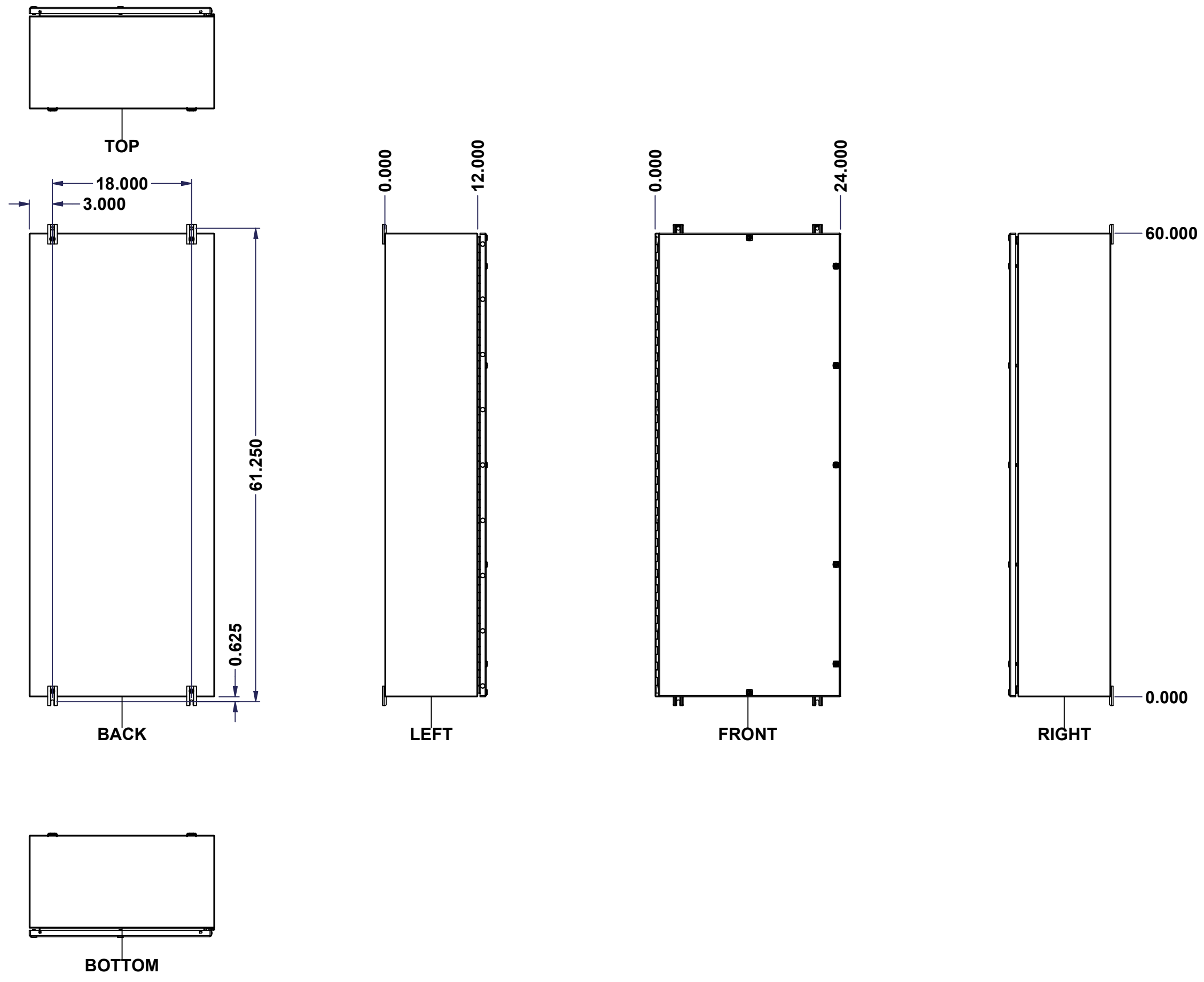

| No. | Revisions | Date | By/Par |
|-----|-----------|------|--------|
|     |           |      |        |
|     |           |      |        |
|     |           |      |        |
|     |           |      |        |
|     |           |      |        |

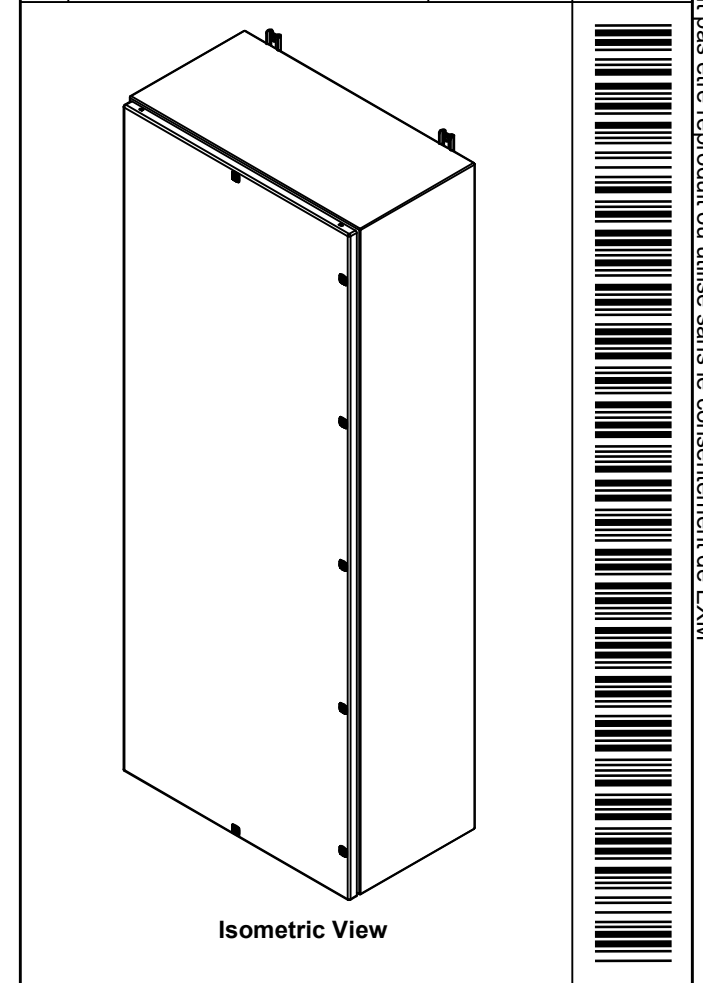

|  |   |  |
|--|---|--|
| Tél: (450) 979-4373<br>Fax: (450) 979-4626<br><a href="http://www.exmweb.com">www.exmweb.com</a> |   | Flatness<br>Aplatissement<br>Max 3.0mm<br>Projection<br> |
| Customer Client  | Date                                      |  |
| Drawn By<br>Dessiné Par  | BoxCad: BoxCad                            | Date 09-Feb-25   |
| Material<br>Matière  | 14 Ga Cold Rolled A1008 CS Type B (1.7mm) |  |
| Color<br>Couleur   | Asa-61 Grey                               | Finish<br>Fini Smooth                                    |
| Description  | Detail Rev.                               |  |
| 5412ESEL 60" x 24" x 12" Assembly  |   |  |
| Part Number<br>Numéro Pièce  | Rev. 0                                    | 1 / 16   |

SEE BILL OF MATERIAL ON LAST PAGE

**5412ESEL602412TH**

This drawing is confidential and must not be reproduced or used without the consent of EXM

Ce dessin est confidentiel et ne doit pas être reproduit ou utilisé sans le consentement de EXM

| NOTE |   |
|------|---|
| ITEM | DESCRIPTION                                     |
| 1    | NEMA 4, 12 Enclosure (IP66)                     |
| 2    | C/W Standard ground studs on box and cover      |
| 3    | C/W Standard door stiffener                     |
| 4    | C/W Standard inner panel (Included)             |
| 5    | C/W Standard inner panel mounting studs         |
| 6    | C/W 885 ESMF3_OPEN Sold separately (Installed)  |
| 7    | C/W 885 ESMF3_CLOSE Sold separately (Installed) |
| 8    | C/W R5 Insulation (Installed aluminum visible)  |

| No. | Revisions | Date | By/Par |
|-----|-----------|------|--------|
|     |           |      |        |
|     |           |      |        |
|     |           |      |        |
|     |           |      |        |
|     |           |      |        |

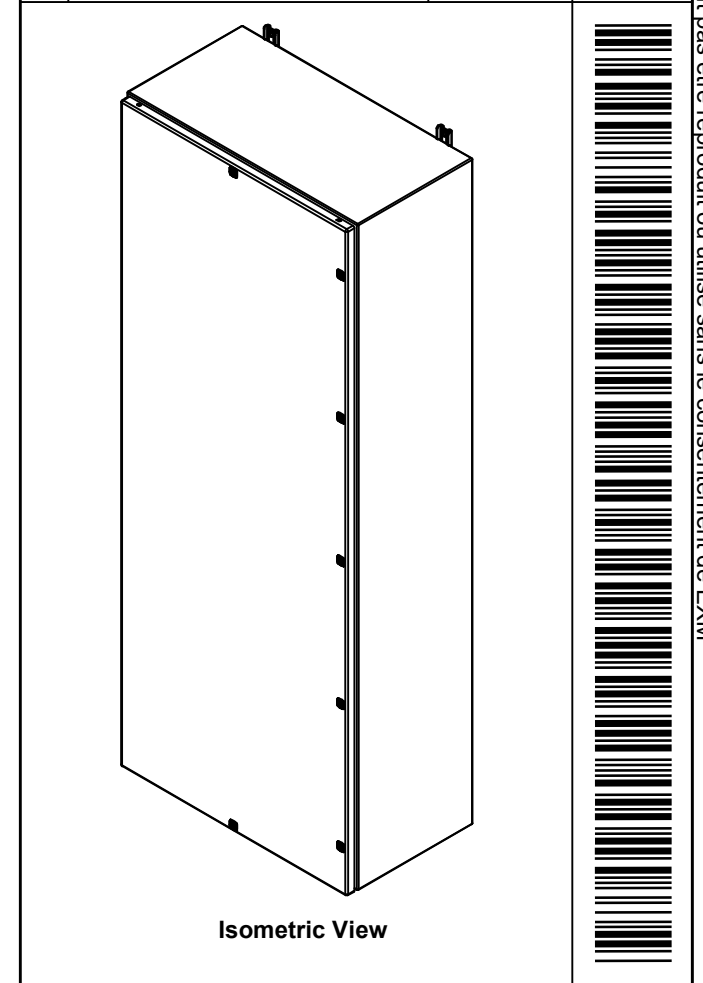

| PACKING               |     |  |
|-----------------------|-----|--|
| ITEM                  | QTY | DESCRIPTION                                    |
| Cardboard sleeve      | 2   | Top and Bottom                                 |
| Cardboard strip       | 2   | Between back of enclosure and inner panel      |
| Plastic bag           | 1   | To protect cover surface and inside gasket     |
| Cardboard corner      | 4   | To reinforced for the plastic strap tightening |
| Plastic strap - Black | 2   | To Squeeze 2 cardboard sleeve together         |
| Packaging label       | 3   | White label with PN                            |
| Plastic strap- Green  | 2   | To secure the enclosure to the wood pallet     |
| Wood Pallet           | 1   | 2" deeper and 3" larger than enclosure size    |

|            |                    |     |   |
|------------|--------------------|-----|---|
| 6          | STK-Q-00600        | 2   | M12 to M8 Adaptor                                       |
| 1          | 885SP6024G         | 0   | 885SP 60" x 24" Inner Panel Part                        |
| 1          | STK-K-01800        | 5   | 5412 ES Accessory Kit                                   |
| 9          | RIVET_NUT_M6_FH_CE | 0   | Rivet Nut M6 (Low Profile Close End)                    |
| 1          | 5412ESEL602412THC  | 0   | 5412ESEL 60" x 24" Cover                                |
| 1          | 5412ESEL602412THB  | 0   | 5412ESEL 60" x 24" x 12" Body                           |
| 9          | STK-Q-04050-14     | 5   | M6 x 14mm Hexagon Socket Head Machine Screw with Nyseal |
| Qty        | Part Number        | Rev | Description   |
| Parts List |                    |     |   |

|   |   |                       |
|---|---|-----------------------|
| <p>Tél: (450) 979-4373<br/>Fax: (450) 979-4626<br/><a href="http://www.exmweb.com">www.exmweb.com</a></p> | Flatness<br>Aplatissement                 | Max 3.0mm             |
|   | Projection                                |                       |
| Customer Client   | Date                                      |                       |
| Drawn By<br>Dessiné Par   | BoxCad: BoxCad                            | Date 09-Feb-25        |
| Material<br>Matière   | 14 Ga Cold Rolled A1008 CS Type B (1.7mm) |                       |
| Color<br>Couleur  | Asa-61 Grey                               | Finish<br>Fini Smooth |
| Description   | Detail Rev.                               |                       |
| 5412ESEL 60" x 24" x 12" Assembly   |   |                       |
| Part Number<br>Numéro Pièce   | Rev. 0                                    | 2 / 16                |
| <b>5412ESEL602412TH</b>   |   |                       |

This drawing is confidential and must not be reproduced or used without the consent of EXM

Ce dessin est confidentiel et ne doit pas être reproduit ou utilisé sans le consentement de EXM

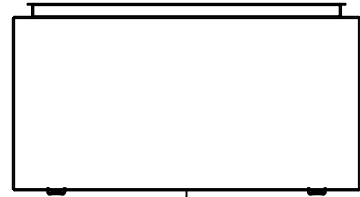

TOP

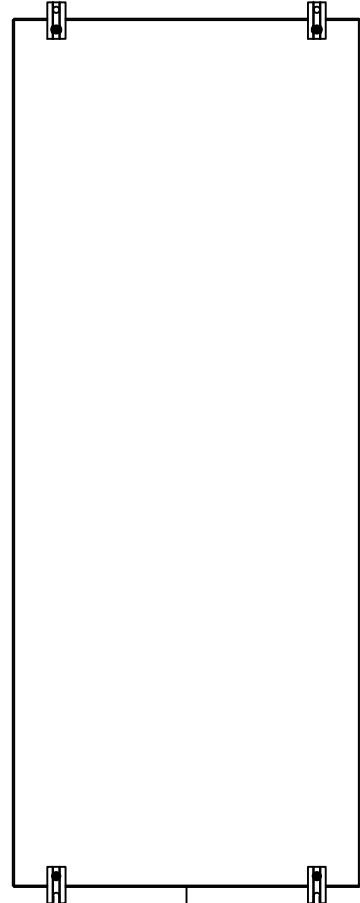

BACK

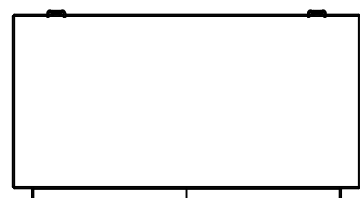

BOTTOM

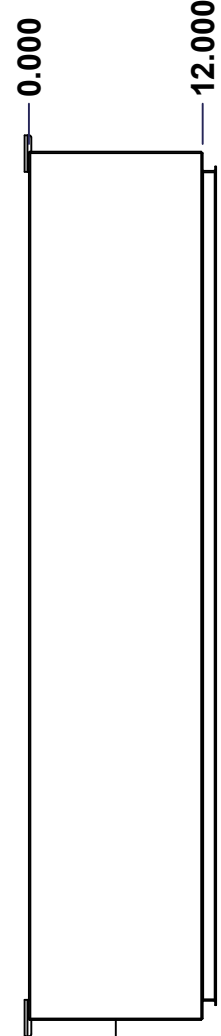

LEFT

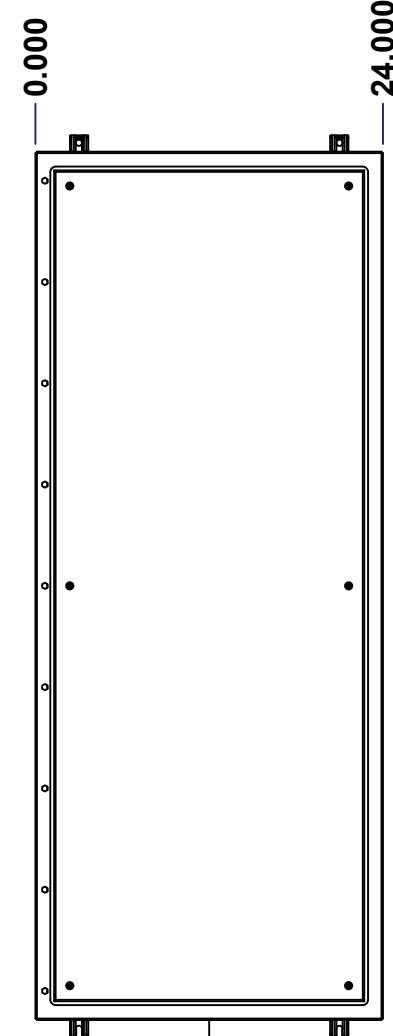

FRONT

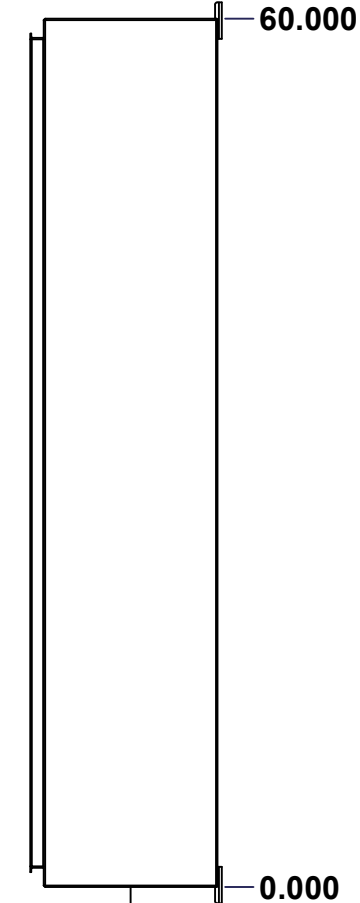

RIGHT

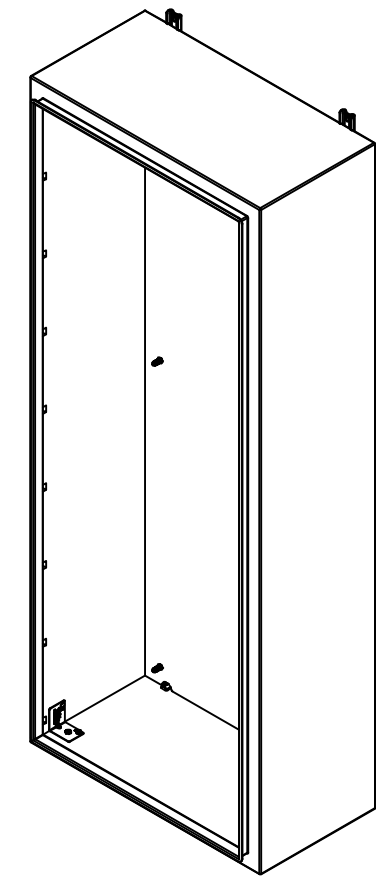

Isometric View

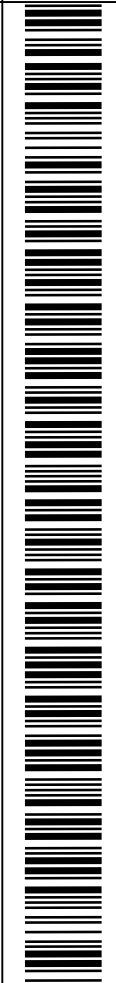

| No. | Revisions | Date | By/Par |
|-----|-----------|------|--------|
|     |           |      |        |
|     |           |      |        |
|     |           |      |        |
|     |           |      |        |
|     |           |      |        |

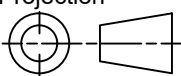
|  |   |   |
|--|---|---|
|  Tél: (450) 979-4373<br>Fax: (450) 979-4626<br><a href="http://www.exmweb.com">www.exmweb.com</a> |   | Flatness<br>Aplatissement<br>Max 3.0mm<br>Projection<br> |
| Customer Client  | Date                                      |   |
| Drawn By<br>Dessiné Par  | BoxCad: BoxCad                            | Date 09-Feb-25  |
| Material<br>Matière  | 14 Ga Cold Rolled A1008 CS Type B (1.7mm) |   |
| Color<br>Couleur   | Asa-61 Grey                               | Finish<br>Fini Smooth   |
| Description  | Detail Rev.                               |   |
| 5412ESEL 60" x 24" x 12" Body  |   |   |
| Part Number<br>Numéro Pièce  | Rev. 0                                    | 3 / 16  |
| <b>5412ESEL602412THB</b>   |   |   |

SEE BILL OF MATERIAL ON LAST PAGE

This drawing is confidential and must not be reproduced or used without the consent of EXM

Ce dessin est confidentiel et ne doit pas être reproduit ou utilisé sans le consentement de EXM

| STANDARD FEATURES ARE NOT LISTED IN THIS HOLE TABLE |        |        |                                |
|---|--------|--------|--------------------------------|
| HOLE TABLE - TOP VIEW (CUSTOM FEATURE ONLY)         |        |        |                                |
| CUT-OUT   | XDIM   | YDIM   | DESCRIPTION                    |
| 1   | 2.000  | 10.000 | INSUL. STUD M6 x 18mm (Inside) |
| 2   | 22.000 | 10.000 | INSUL. STUD M6 x 18mm (Inside) |

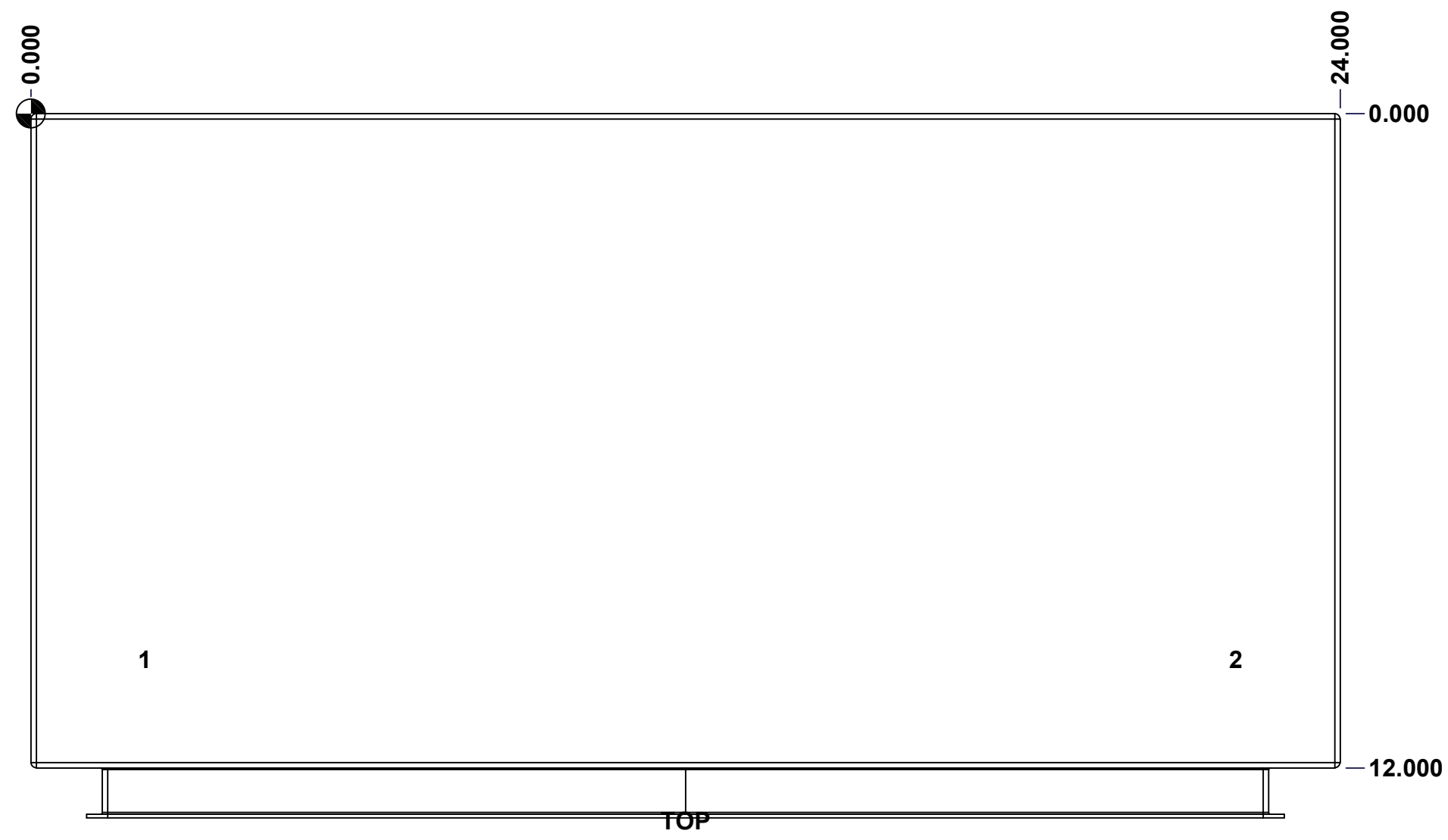

|  |                               |              |
|--|-------------------------------|--------------|
|  | Description                   | Status       |
|  | 5412ESEL 60" x 24" x 12" Body | (NULL)       |
|  | Part Number<br>Numéro Pièce   | Rev.         |
|  | <b>5412ESEL602412THB</b>      | <b>0</b> / 4 |
|  |                               | 16           |

This drawing is confidential and must not be reproduced or used without the consent of EXM

Ce dessin est confidentiel et ne doit pas être reproduit ou utilisé sans le consentement de EXM

| <b>STANDARD FEATURES ARE NOT LISTED IN THIS HOLE TABLE</b> |        |        |                                |
|--|--------|--------|--------------------------------|
| <b>HOLE TABLE - BOTTOM VIEW (CUSTOM FEATURE ONLY)</b>      |        |        |                                |
| CUT-OUT  | XDIM   | YDIM   | DESCRIPTION                    |
| 1  | 2.000  | 10.000 | INSUL. STUD M6 x 18mm (Inside) |
| 2  | 22.000 | 10.000 | INSUL. STUD M6 x 18mm (Inside) |



|  |                               |              |
|--|-------------------------------|--------------|
|  | Description                   | Status       |
|  | 5412ESEL 60" x 24" x 12" Body | (NULL)       |
|  | Part Number<br>Numéro Pièce   | Rev.         |
|  | <b>5412ESEL602412THB</b>      | <b>0</b> / 5 |
|  |                               | 16           |

This drawing is confidential and must not be reproduced or used without the consent of EXM

Ce dessin est confidentiel et ne doit pas être reproduit ou utilisé sans le consentement de EXM

**STANDARD FEATURES ARE NOT LISTED IN THIS HOLE TABLE**

**HOLE TABLE - BACK VIEW (CUSTOM FEATURE ONLY)**

| CUT-OUT | XDIM   | YDIM   | DESCRIPTION                |
|---------|--------|--------|----------------------------|
| 1       | 2.375  | 2.375  | IP STUD M8 x 35mm (Inside) |
| 2       | 2.375  | 57.625 | IP STUD M8 x 35mm (Inside) |
| 3       | 21.625 | 57.625 | IP STUD M8 x 35mm (Inside) |
| 4       | 21.625 | 2.375  | IP STUD M8 x 35mm (Inside) |
| 5       | 2.375  | 30.000 | IP STUD M8 x 35mm (Inside) |
| 6       | 21.625 | 30.000 | IP STUD M8 x 35mm (Inside) |
| -----   |        |        |                            |
| 7       | 21.000 | 0.000  | FOOT 885 ESMF3_OPEN        |
| 8       | 3.000  | 0.000  | FOOT 885 ESMF3_OPEN        |
| 9       | 21.000 | 60.000 | FOOT 885 ESMF3_CLOSE       |
| 10      | 3.000  | 60.000 | FOOT 885 ESMF3_CLOSE       |

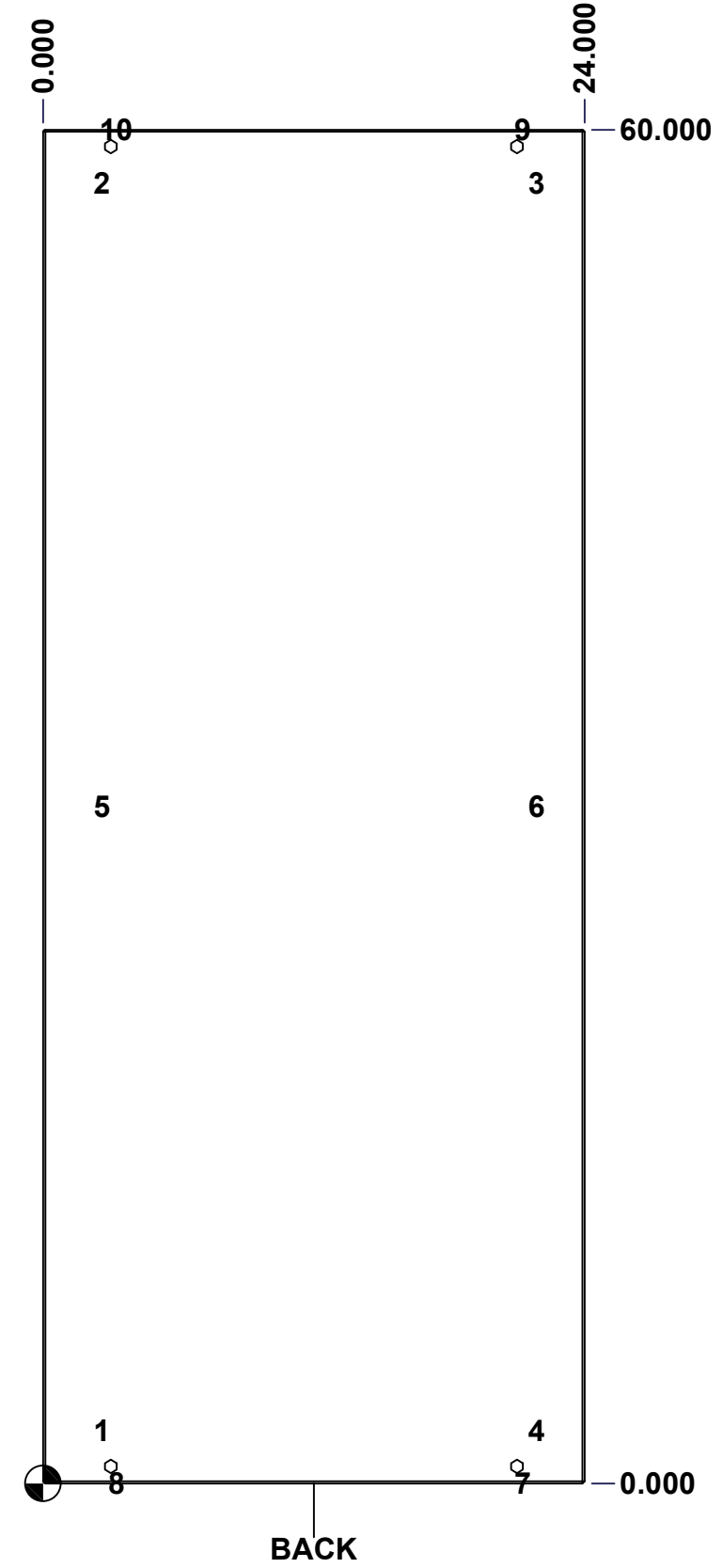

|   |                               |        |
|---|-------------------------------|--------|
|   | Description                   | Status |
|   | 5412ESEL 60" x 24" x 12" Body | (NULL) |
| Part Number<br>Numéro Pièce<br><b>5412ESEL602412THB</b> | Rev.                          | 6      |
|   | <b>0</b>                      | 16     |

This drawing is confidential and must not be reproduced or used without the consent of EXM

Ce dessin est confidentiel et ne doit pas être reproduit ou utilisé sans le consentement de EXM

| No. | Revisions | Date | By/Par |
|-----|-----------|------|--------|
|     |           |      |        |
|     |           |      |        |
|     |           |      |        |
|     |           |      |        |
|     |           |      |        |

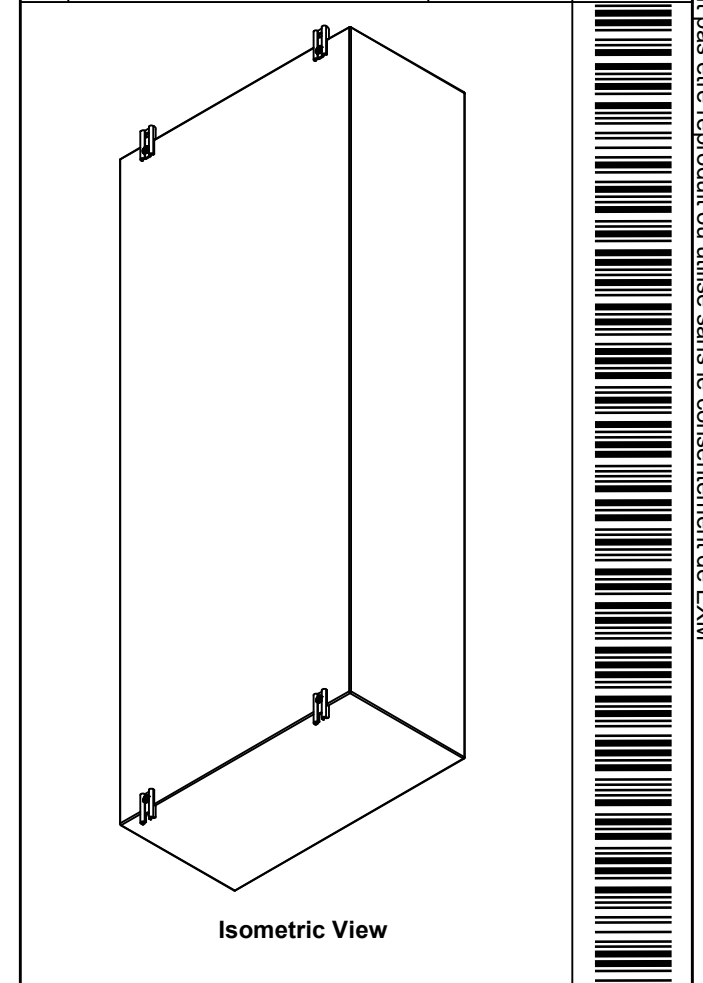

|            |                      |     |  |
|------------|----------------------|-----|--|
| 1          | 885 ESMF3            | 0   | 885 ESMF3 Mounting Foot Kit            |
| 4          | RIVET_NUT_M10_FH_CE  | 0   | Rivet Nut M10 (Low Profile Close End)  |
| 1          | STK-K-70554          | 3   | 5412 ESTH Accessory Kit                |
| 1          | 5412ESEL602412THI-RS | 0   | 5412ESEL 60" x 24" Right Insulation    |
| 1          | 5412ESEL602412THI-LS | 0   | 5412ESEL 60" x 24" Left Insulation     |
| 1          | 5412ESEL602412THI-BT | 0   | 5412ESEL 60" x 24"Bottom Insulation    |
| 1          | 5412ESEL602412THI-TP | 0   | 5412ESEL 60" x 24"Top Insulation       |
| 1          | 5412ESEL602412THI-B  | 0   | 5412ESEL 60" x 24" Back Insulation     |
| 4          | STK-Q-16055          | 1   | M6 x 18mm Stud (No Paint Cap Required) |
| 1          | STK-P-02400S         | 0   | Powder Paint (Asa-61 Grey / Smooth)    |
| 6          | STK-Q-16005          | 0   | Stud M8 x 35mm Steel                   |
| 1          | 5412ESEL602412THB-P  | 0   | 5412ESEL 60" x 24" x 12" Body Part     |
| Qty        | Part Number          | Rev | Description                            |
| Parts List |                      |     |  |

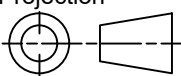
|  |   |  |
|--|---|--|
|  Tél: (450) 979-4373<br>Fax: (450) 979-4626<br><a href="http://www.exmweb.com">www.exmweb.com</a> |   | Flatness<br>Aplatissement<br>Max 3.0mm |
| Projection<br>  |   | Date<br>09-Feb-25                      |
| Customer<br>Client   | BoxCad: BoxCad                            | Date                                   |
| Drawn By<br>Dessiné Par  | BoxCad: BoxCad                            | Date                                   |
| Material<br>Matière  | 14 Ga Cold Rolled A1008 CS Type B (1.7mm) |  |
| Color<br>Couleur   | Asa-61 Grey                               | Finish<br>Fini<br>Smooth               |
| Description  | 5412ESEL 60" x 24" x 12" Body             |  |
| Part Number<br>Numéro Pièce  | Rev.                                      | 7                                      |
| <b>5412ESEL602412THB</b>   | <b>0</b>                                  | 16                                     |

This drawing is confidential and must not be reproduced or used without the consent of EXM

Ce dessin est confidentiel et ne doit pas être reproduit ou utilisé sans le consentement de EXM

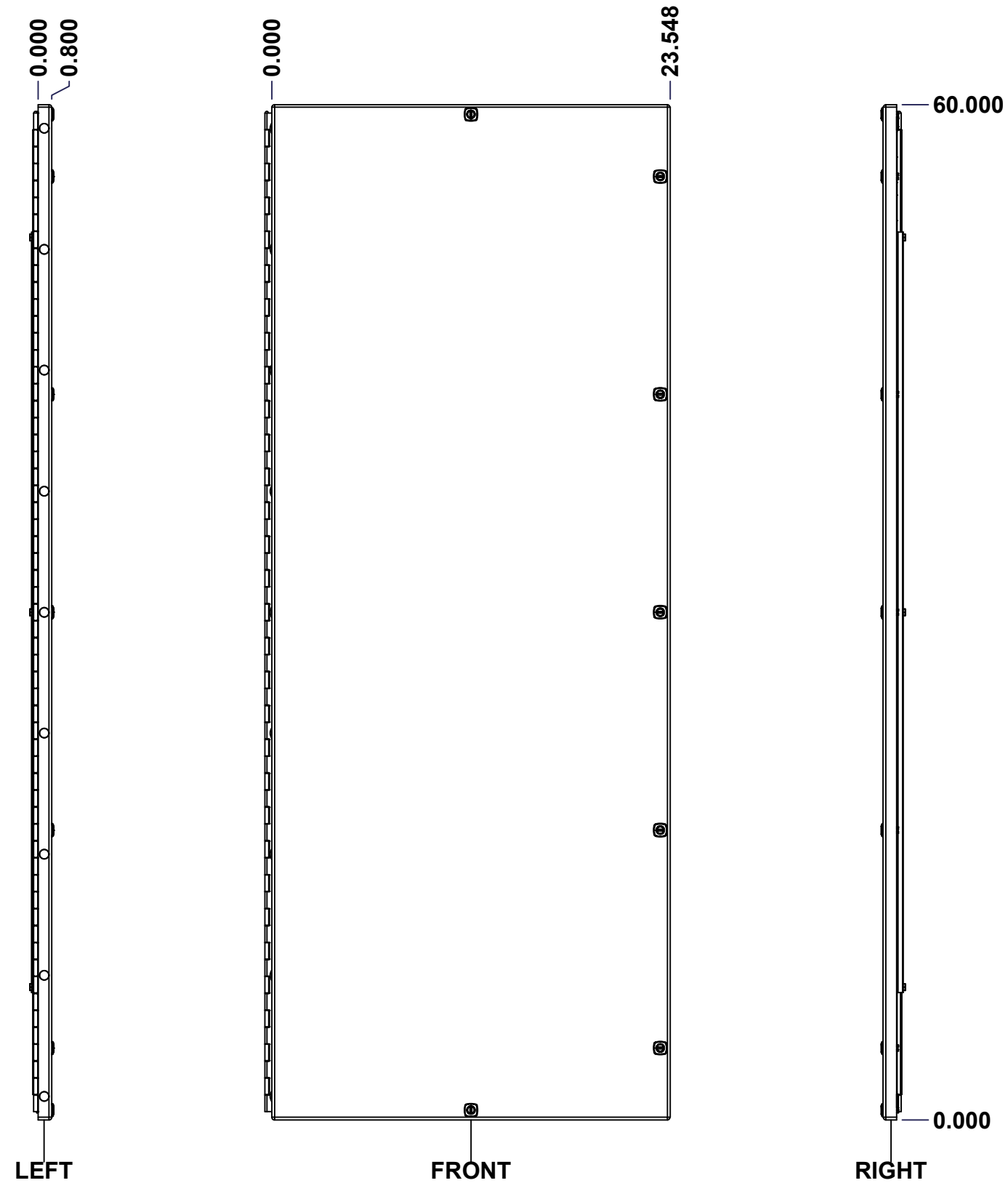
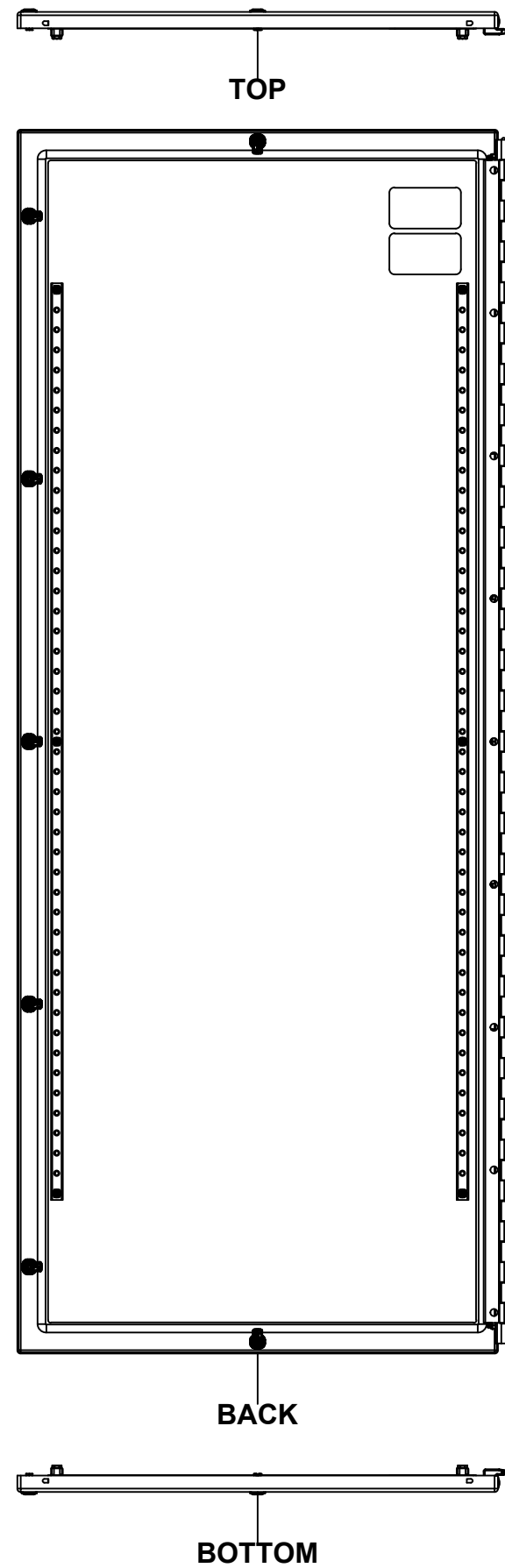

| No. | Revisions | Date | By/Par |
|-----|-----------|------|--------|
|     |           |      |        |
|     |           |      |        |
|     |           |      |        |
|     |           |      |        |

Isometric View

|   |  |                           |             |
|---|--|---------------------------|-------------|
| <p>Tél: (450) 979-4373<br/>                 Fax: (450) 979-4626<br/> <a href="http://www.exmweb.com">www.exmweb.com</a></p> |  | Flatness<br>Aplatissement |             |
|   |  | Max 3.0mm                 |             |
| Customer<br>Client  |  | Date                      |             |
| Drawn By<br>Dessiné Par BoxCad: BoxCad  |  | Date 09-Feb-25            |             |
| Material<br>Matière 14 Ga Cold Rolled A1008 CS Type B (1.7mm)   |  |                           |             |
| Color<br>Couleur Asa-61 Grey  |  | Finish<br>Fini Smooth     |             |
| Description<br>5412ESEL 60" x 24" Cover   |  |                           | Detail Rev. |
| Part Number<br>Numéro Pièce <b>5412ESEL602412THC</b>  |  | Rev. <b>0</b>             | 8<br>16     |

SEE BILL OF MATERIAL ON LAST PAGE

This drawing is confidential and must not be reproduced or used without the consent of EXM

Ce dessin est confidentiel et ne doit pas être reproduit ou utilisé sans le consentement de EXM

**STANDARD FEATURES ARE NOT LISTED IN THIS HOLE TABLE**

**HOLE TABLE - FRONT VIEW (CUSTOM FEATURE ONLY)**

| CUT-OUT | XDIM   | YDIM   | DESCRIPTION               |
|---------|--------|--------|---------------------------|
| 1       | 1.729  | 7.854  | STUD M6 x 18mm (Inside)   |
| 2       | 1.729  | 52.146 | STUD M6 x 18mm (Inside)   |
| 3       | 1.729  | 30.000 | STUD M6 x 18mm (Inside)   |
| 4       | 21.609 | 7.854  | STUD M6 x 18mm (Inside)   |
| 5       | 21.609 | 52.146 | STUD M6 x 18mm (Inside)   |
| 6       | 21.609 | 30.000 | STUD M6 x 18mm (Inside)   |
| -----   |        |        |                           |
| 7       | 22.968 | 55.750 | LOCK 880 SCQ5-SL @ 180.0° |
| 8       | 22.968 | 17.125 | LOCK 880 SCQ5-SL @ 180.0° |
| 9       | 22.968 | 30.000 | LOCK 880 SCQ5-SL @ 180.0° |
| 10      | 11.774 | 59.420 | LOCK 880 SCQ5-SL @ 270.0° |
| 11      | 11.774 | 0.580  | LOCK 880 SCQ5-SL @ 90.0°  |
| 12      | 22.968 | 42.875 | LOCK 880 SCQ5-SL @ 180.0° |
| 13      | 22.968 | 4.250  | LOCK 880 SCQ5-SL @ 180.0° |

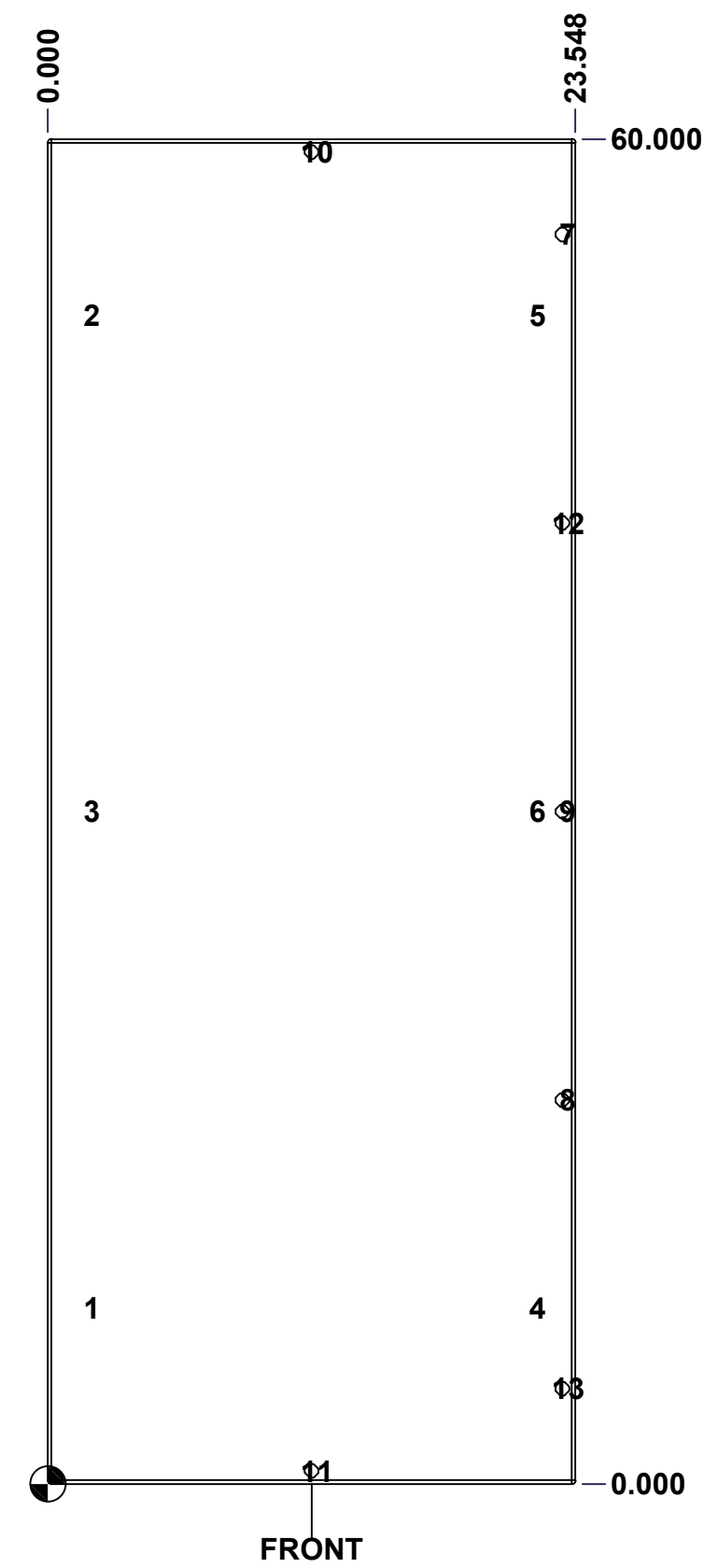

|   |                          |        |
|---|--------------------------|--------|
|   | Description              | Status |
|   | 5412ESEL 60" x 24" Cover | (NULL) |
| Part Number<br>Numéro Pièce<br><b>5412ESEL602412THC</b> | Rev.                     | 9      |
|   | <b>0</b>                 | 16     |

This drawing is confidential and must not be reproduced or used without the consent of EXM

Ce dessin est confidentiel et ne doit pas être reproduit ou utilisé sans le consentement de EXM

| No. | Revisions | Date | By/Par |
|-----|-----------|------|--------|
|     |           |      |        |
|     |           |      |        |
|     |           |      |        |
|     |           |      |        |
|     |           |      |        |

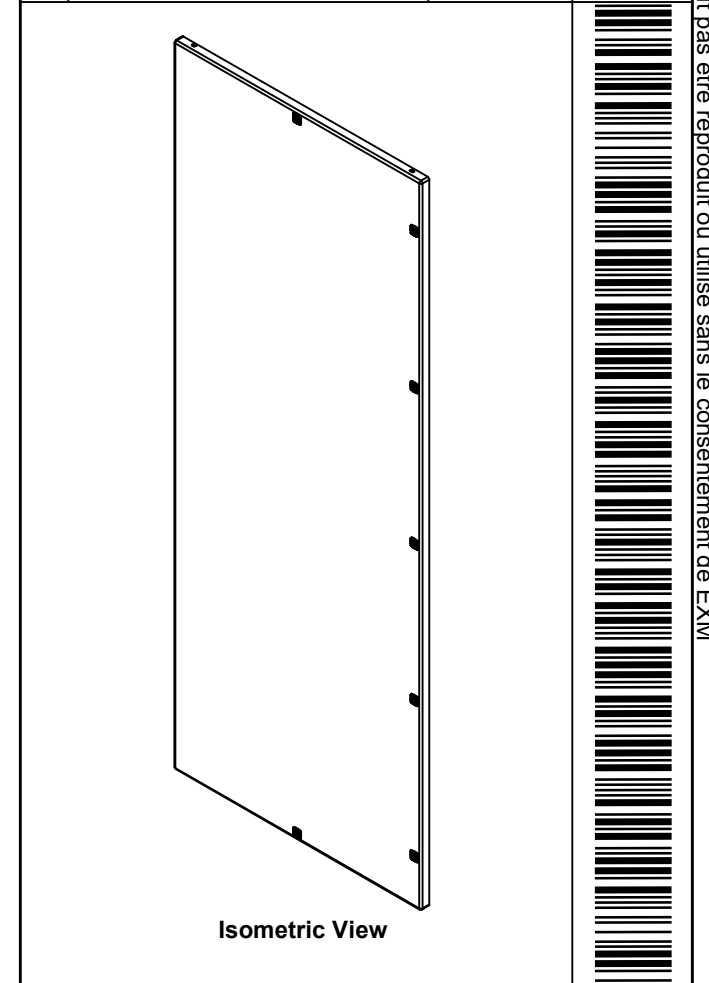

| 2          | STK-S-00100          | 0   | 3.5" x 2" Silver Milar Flexcon Sticker   |
|------------|----------------------|-----|--|
| 6          | STK-Q-07250          | 2   | M6 x 16mm Collar Nut                     |
| 2          | STK-Q-46020-48       | 5   | 5412 ES Vertical Door Stiffener 48"      |
| 1          | 5412ESEL602412THI-C  | 0   | 5412ESEL 60" x 24" Cover Insulation      |
| 1          | STK-P-02400S         | 0   | Powder Paint (Asa-61 Grey / Smooth)      |
| 6          | STK-Q-16055          | 1   | M6 x 18mm Stud (No Paint Cap Required)   |
| 9          | STK-Q-00260          | 1   | M6 x 13mm Carriage Bolt                  |
| 1          | 5412ESEL602412THHP-P | 0   | Piano Hinge Pin (Length= 59.181")        |
| 1          | 5412ESEL602412THH1-P | 0   | 5412ESEL 60" x 24" Piano Hinge Part      |
| 1          | 5412ESEL602412THH2-P | 0   | 5412ESEL 60" x 24" Piano Hinge Part      |
| 1          | 5412ESEL602412THG    | 0   | 5412ESEL 60" x 24" Cover Gasket Part     |
| 1          | 5412ESEL602412THC-P  | 0   | 5412ESEL 60" x 24" Cover Part            |
| 7          | 880 SCQ5-SL          |     | 5412 ESEL 1/4 Turn Lock                  |
| 9          | STK-Q-07225          | 0   | M6 Stainless Steel Nylon Insert Lock Nut |
| QTY        | Part Number          | Rev | Description                              |
| Parts List |                      |     |  |

|   |  |
|---|--|
|   | Flatness<br>Aplatissement<br>Max 3.0mm |
|   | Projection<br>                         |
| Customer<br>Client  | Date                                   |
| Drawn By<br>Dessiné Par BoxCad: BoxCad                        | Date 09-Feb-25                         |
| Material<br>Matière 14 Ga Cold Rolled A1008 CS Type B (1.7mm) | Color<br>Couleur Asa-61 Grey           |
| Description<br>5412ESEL 60" x 24" Cover                       | Finish<br>Fini Smooth                  |
| Part Number<br>Numéro Pièce<br><b>5412ESEL602412THC</b>       | Rev. 10<br><b>0</b> 16                 |

This drawing is confidential and must not be reproduced or used without the consent of EXM

Ce dessin est confidentiel et ne doit pas être reproduit ou utilisé sans le consentement de EXM

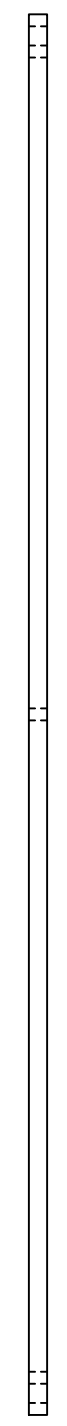
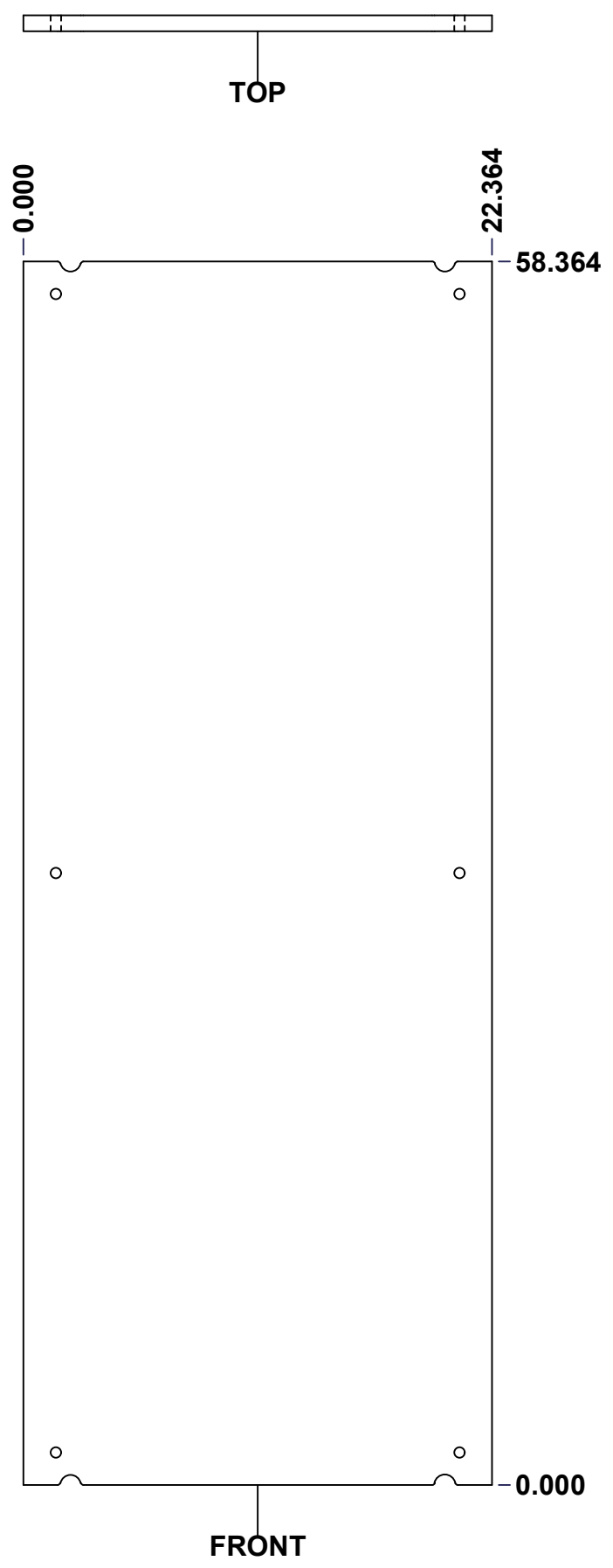

| No. | Revisions | Date | By/Par |
|-----|-----------|------|--------|
|     |           |      |        |
|     |           |      |        |
|     |           |      |        |
|     |           |      |        |
|     |           |      |        |

**Isometric View**

|   |                    |                           |
|---|--------------------|---------------------------|
| <p>Tél: (450) 979-4373<br/>                 Fax: (450) 979-4626<br/> <a href="http://www.exmweb.com">www.exmweb.com</a></p> |                    | Flatness<br>Aplatissement |
|   |                    | Max 3.0mm                 |
| Customer<br>Client  |                    | Date                      |
| Drawn By<br>Dessiné Par BoxCad: Patrick Deschenes   |                    | Date 23-Jan-07            |
| Material<br>Matière Polyisocyanurate  |                    |                           |
| Color<br>Couleur Aluminum   | Finish<br>Fini N/A |                           |
| Description<br>5412ESEL 60" x 24" Back Insulation   |                    | Detail Rev.               |
| Part Number<br>Numéro Pièce <b>5412ESEL602412THI-B</b>  |                    | Rev. 11<br><b>0</b> 16    |

**SEE BILL OF MATERIAL ON LAST PAGE**

This drawing is confidential and must not be reproduced or used without the consent of EXM

Ce dessin est confidentiel et ne doit pas être reproduit ou utilisé sans le consentement de EXM

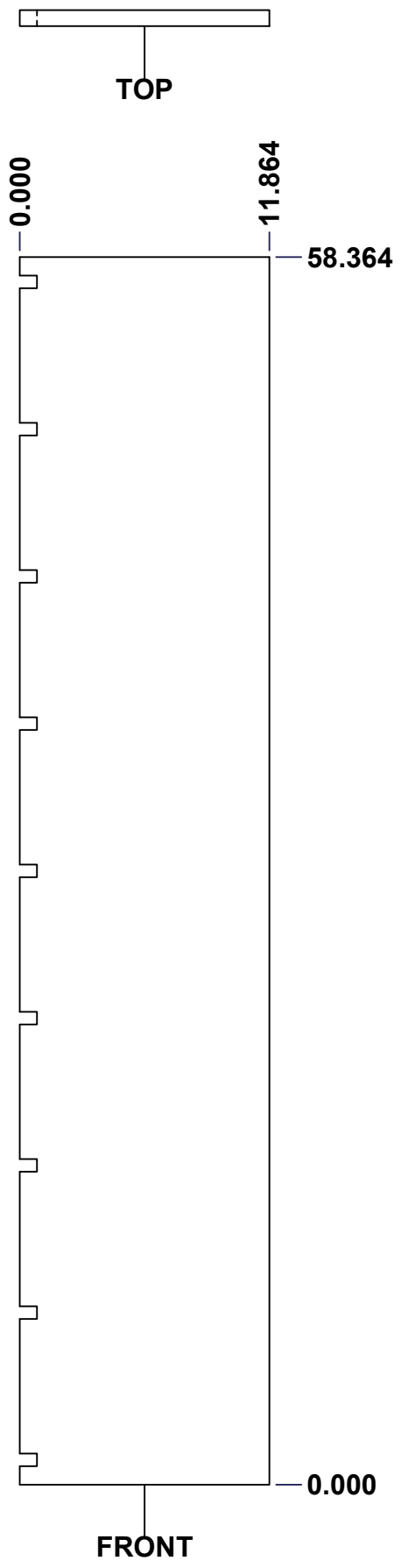

| No. | Revisions | Date | By/Par |
|-----|-----------|------|--------|
|     |           |      |        |
|     |           |      |        |
|     |           |      |        |
|     |           |      |        |

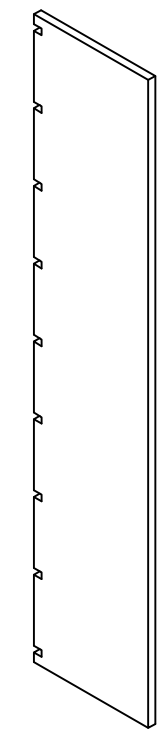

Isometric View

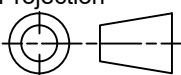

|  |                           |   |
|--|---------------------------|---|
|  Tél: (450) 979-4373<br>Fax: (450) 979-4626<br><a href="http://www.exmweb.com">www.exmweb.com</a> | Flatness<br>Aplatissement | Max 3.0mm   |
|  | Projection                |  |
| Customer<br>Client   | Date                      |   |
| Drawn By<br>Dessiné Par  | BoxCad: Patrick Deschenes | Date 23-Jan-07  |
| Material<br>Matière  | Polyisocyanurate          |   |
| Color<br>Couleur   | Aluminum                  | Finish<br>Fini N/A  |
| Description  | Detail Rev.               |   |
| 5412ESEL 60" x 24" Left Insulation   |                           |   |
| Part Number<br>Numéro Pièce  | Rev.                      | 12  |
| <b>5412ESEL602412THI-LS</b>  | <b>0</b>                  | 16  |

SEE BILL OF MATERIAL ON LAST PAGE

This drawing is confidential and must not be reproduced or used without the consent of EXM

Ce dessin est confidentiel et ne doit pas être reproduit ou utilisé sans le consentement de EXM

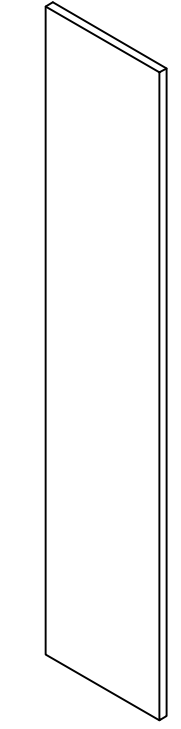
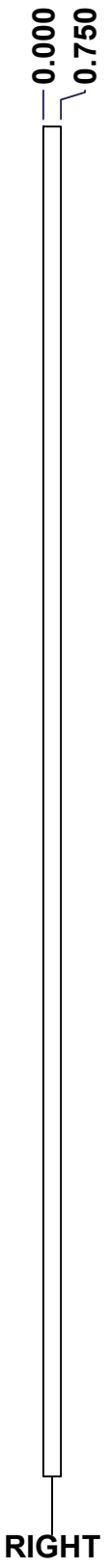
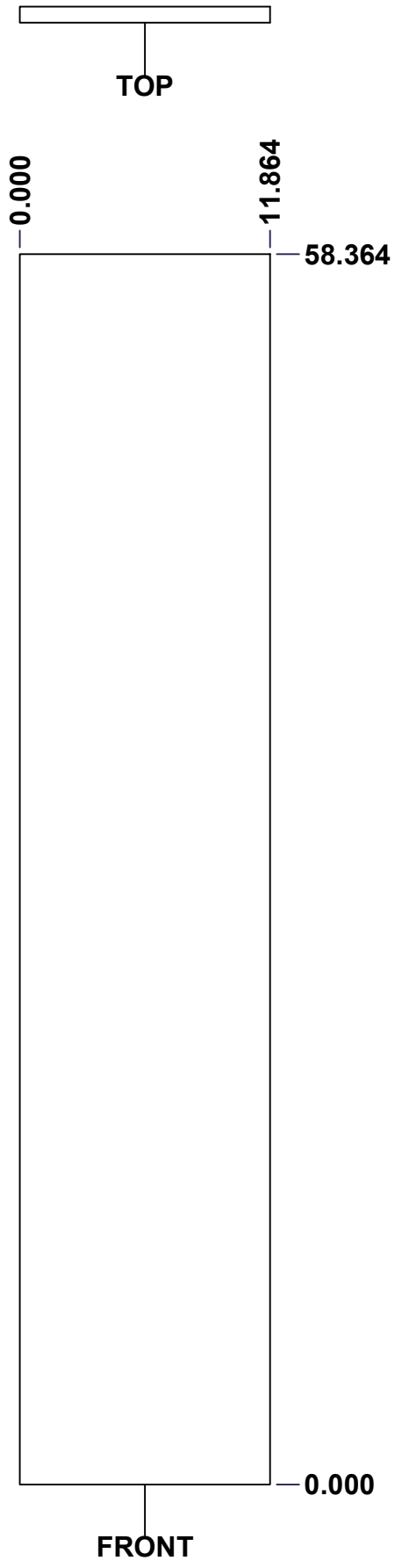

Isometric View

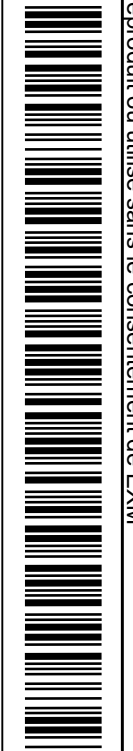

| No. | Revisions | Date | By/Par |
|-----|-----------|------|--------|
|     |           |      |        |
|     |           |      |        |
|     |           |      |        |
|     |           |      |        |

|  |                           |  |
|--|---------------------------|--|
|  Tél: (450) 979-4373<br>Fax: (450) 979-4626<br><a href="http://www.exmweb.com">www.exmweb.com</a> |                           | Flatness<br>Aplatissement<br>Max 3.0mm |
| Customer Client  |                           | Date                                   |
| Drawn By<br>Dessiné Par  | BoxCad: Patrick Deschenes | Date 23-Jan-07                         |
| Material<br>Matière Polyisocyanurate   |                           |  |
| Color<br>Couleur Aluminum  | Finish<br>Fini N/A        |  |
| Description<br>5412ESEL 60" x 24" Right Insulation   |                           | Detail Rev.                            |
| Part Number<br>Numéro Pièce <b>5412ESEL602412THI-RS</b>  |                           | Rev. 13<br><b>0</b>                    |

SEE BILL OF MATERIAL ON LAST PAGE

This drawing is confidential and must not be reproduced or used without the consent of EXM

Ce dessin est confidentiel et ne doit pas être reproduit ou utilisé sans le consentement de EXM

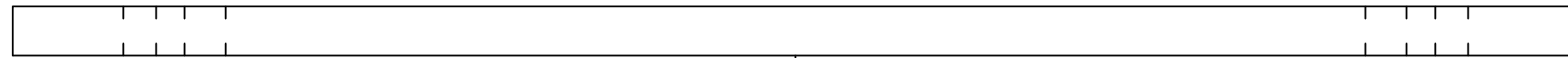

TOP



FRONT

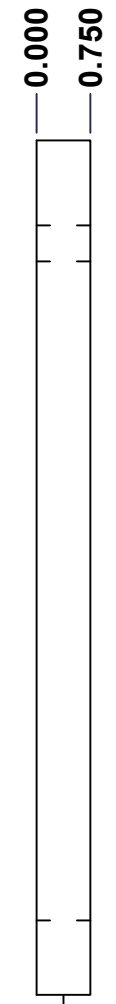

RIGHT

| No. | Revisions | Date | By/Par |
|-----|-----------|------|--------|
|     |           |      |        |
|     |           |      |        |
|     |           |      |        |
|     |           |      |        |

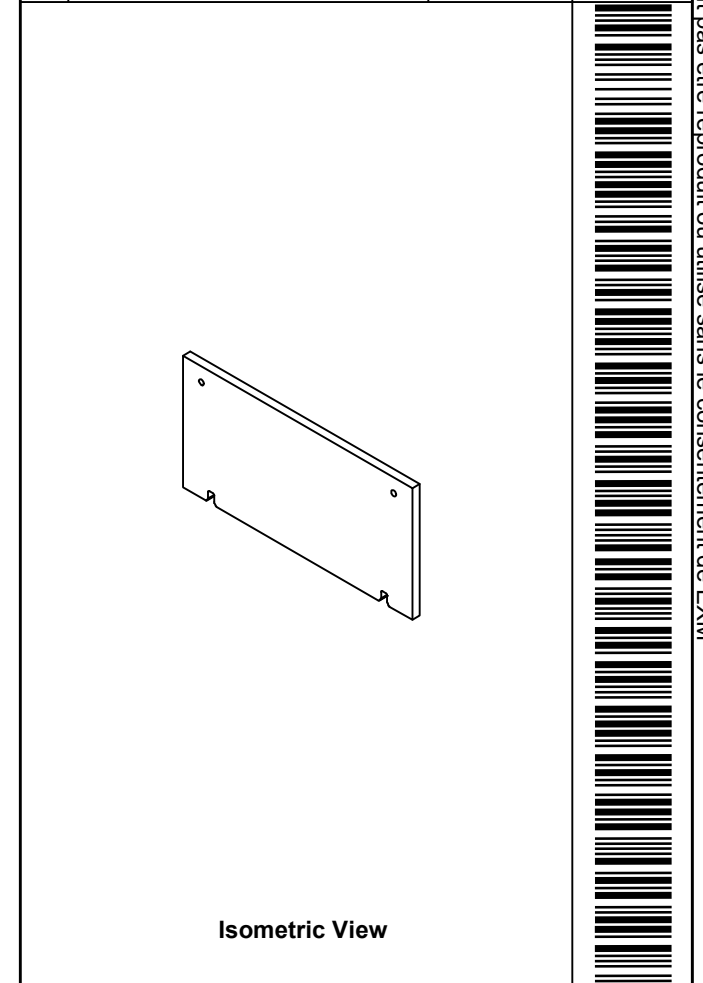

Isometric View



Tél: (450) 979-4373  
 Fax: (450) 979-4626  
[www.exmweb.com](http://www.exmweb.com)

Flatness  
Aplatissement  
Max 3.0mm  
Projection

|   |                       |
|---|-----------------------|
| Customer Client   | Date                  |
| Drawn By<br>Dessiné Par BoxCad: BoxCad                  | Date 4/3/2024         |
| Material<br>Matière Polyisocyanurate                    |                       |
| Color<br>Couleur Aluminum                               | Finish<br>Fini Smooth |
| Description<br>5412ESEL 60" x 24"Top Insulation         | Detail Rev.           |
| Part Number<br>Numéro Pièce <b>5412ESEL602412THI-TP</b> | Rev. <b>0</b>         |

SEE BILL OF MATERIAL ON LAST PAGE

This drawing is confidential and must not be reproduced or used without the consent of EXM

Ce dessin est confidentiel et ne doit pas être reproduit ou utilisé sans le consentement de EXM

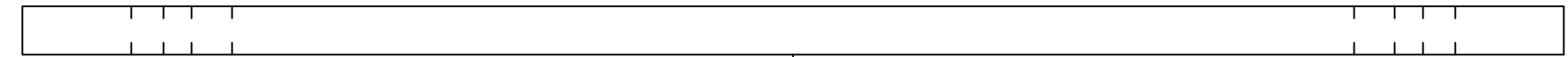

TOP

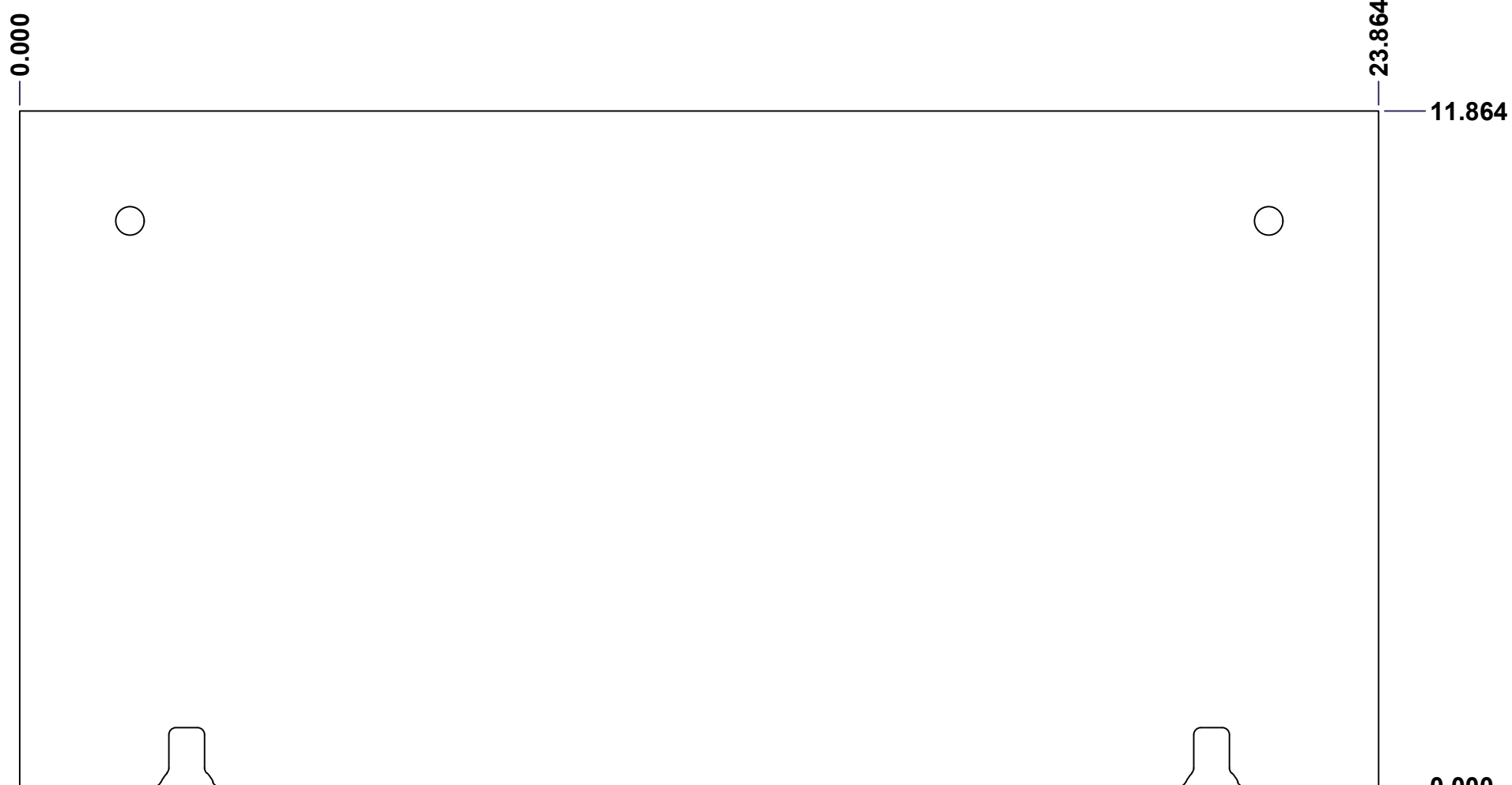

FRONT

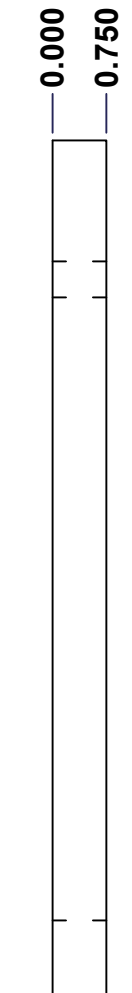

RIGHT

| No. | Revisions | Date | By/Par |
|-----|-----------|------|--------|
|     |           |      |        |
|     |           |      |        |
|     |           |      |        |
|     |           |      |        |
|     |           |      |        |

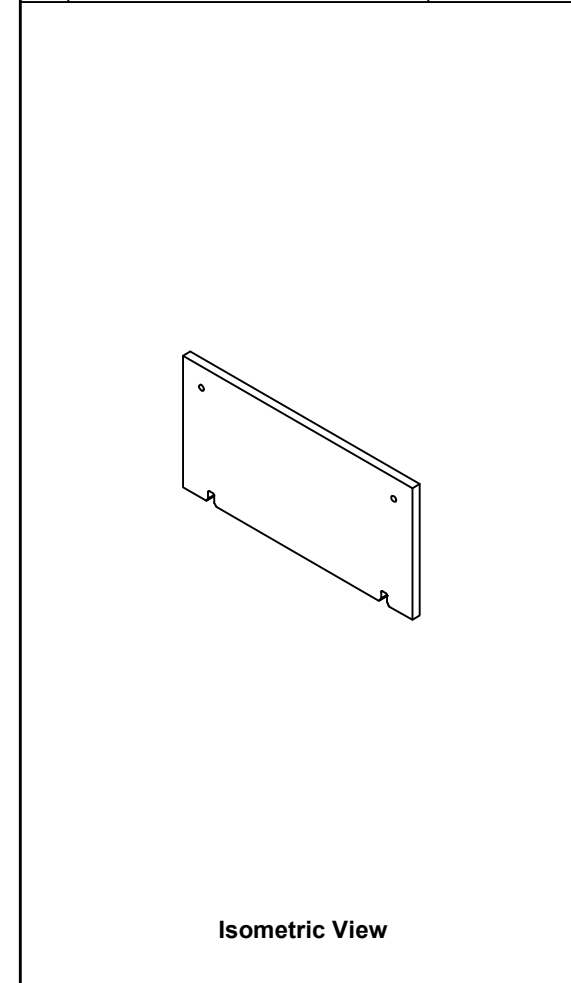

Isometric View

 Tél: (450) 979-4373  
 Fax: (450) 979-4626  
[www.exmweb.com](http://www.exmweb.com)

Flatness / Aplatissement: Max 3.0mm  
 Projection: 

|  |                |
|--|----------------|
| Customer Client                        | Date           |
| Drawn By / Dessiné Par: BoxCad: BoxCad | Date: 4/3/2024 |

Material / Matière: Polyisocyanurate

|                           |                       |
|---------------------------|-----------------------|
| Color / Couleur: Aluminum | Finish / Fini: Smooth |
|---------------------------|-----------------------|

|  |             |
|--|-------------|
| Description: 5412ESEL 60" x 24"Bottom Insulation | Detail Rev. |
|--|-------------|

|  |        |    |    |
|--|--------|----|----|
| Part Number / Numéro Pièce: 5412ESEL602412THI-BT | Rev. 0 | 15 | 16 |
|--|--------|----|----|

SEE BILL OF MATERIAL ON LAST PAGE

This drawing is confidential and must not be reproduced or used without the consent of EXM

Ce dessin est confidentiel et ne doit pas être reproduit ou utilisé sans le consentement de EXM

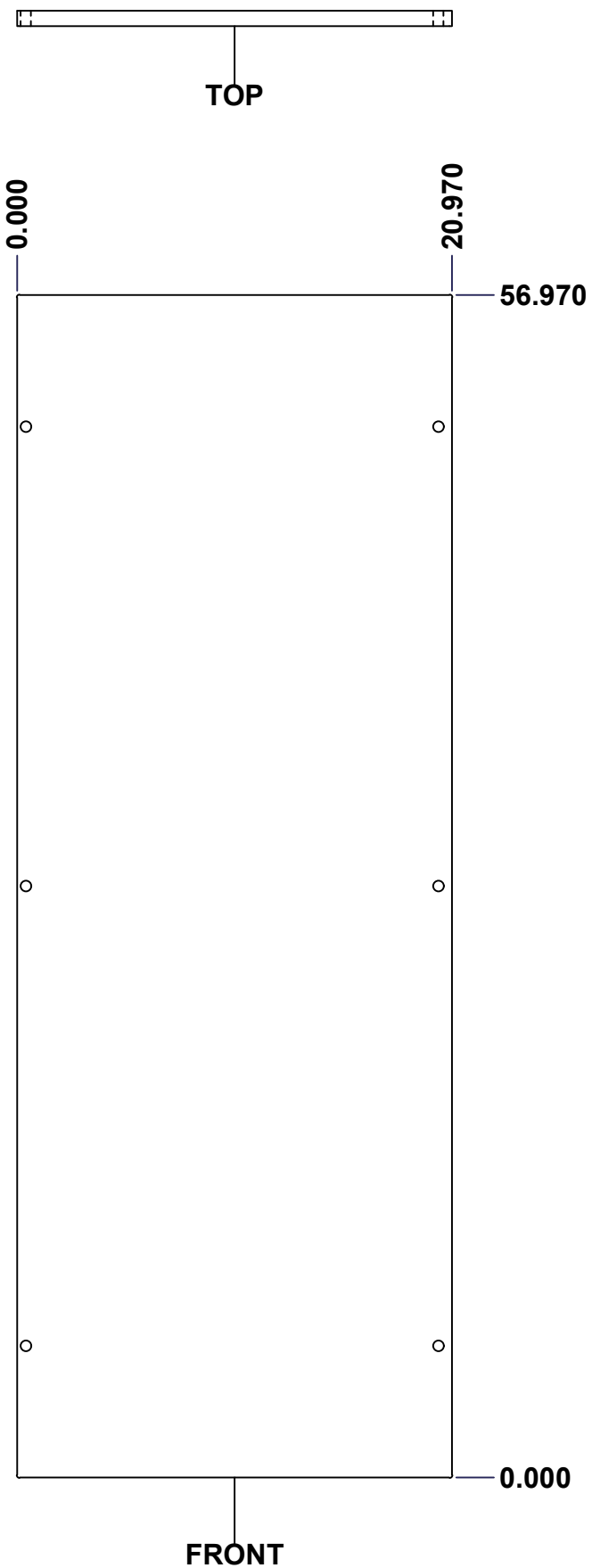

| No. | Revisions | Date | By/Par |
|-----|-----------|------|--------|
|     |           |      |        |
|     |           |      |        |
|     |           |      |        |
|     |           |      |        |

**Isometric View**

|   |                           |                           |
|---|---------------------------|---------------------------|
| <p>Tél: (450) 979-4373<br/>                 Fax: (450) 979-4626<br/> <a href="http://www.exmweb.com">www.exmweb.com</a></p> |                           | Flatness<br>Aplatissement |
|   |                           | Max 3.0mm                 |
| Projection<br>  |                           | Date                      |
| Customer<br>Client  | BoxCad: Patrick Deschenes | Date 23-Jan-07            |
| Material<br>Matière   | Polyisocyanurate          |                           |
| Color<br>Couleur  | Aluminum                  | Finish<br>Fini N/A        |
| Description   |                           | Detail Rev.               |
| 5412ESEL 60" x 24" Cover Insulation   |                           |                           |
| Part Number<br>Numéro Pièce   | Rev.                      | 16                        |
| <b>5412ESEL602412THI-C</b>  | <b>0</b>                  | 16                        |

**SEE BILL OF MATERIAL ON LAST PAGE**

This drawing is confidential and must not be reproduced or used without the consent of EXM

Ce dessin est confidentiel et ne doit pas être reproduit ou utilisé sans le consentement de EXM

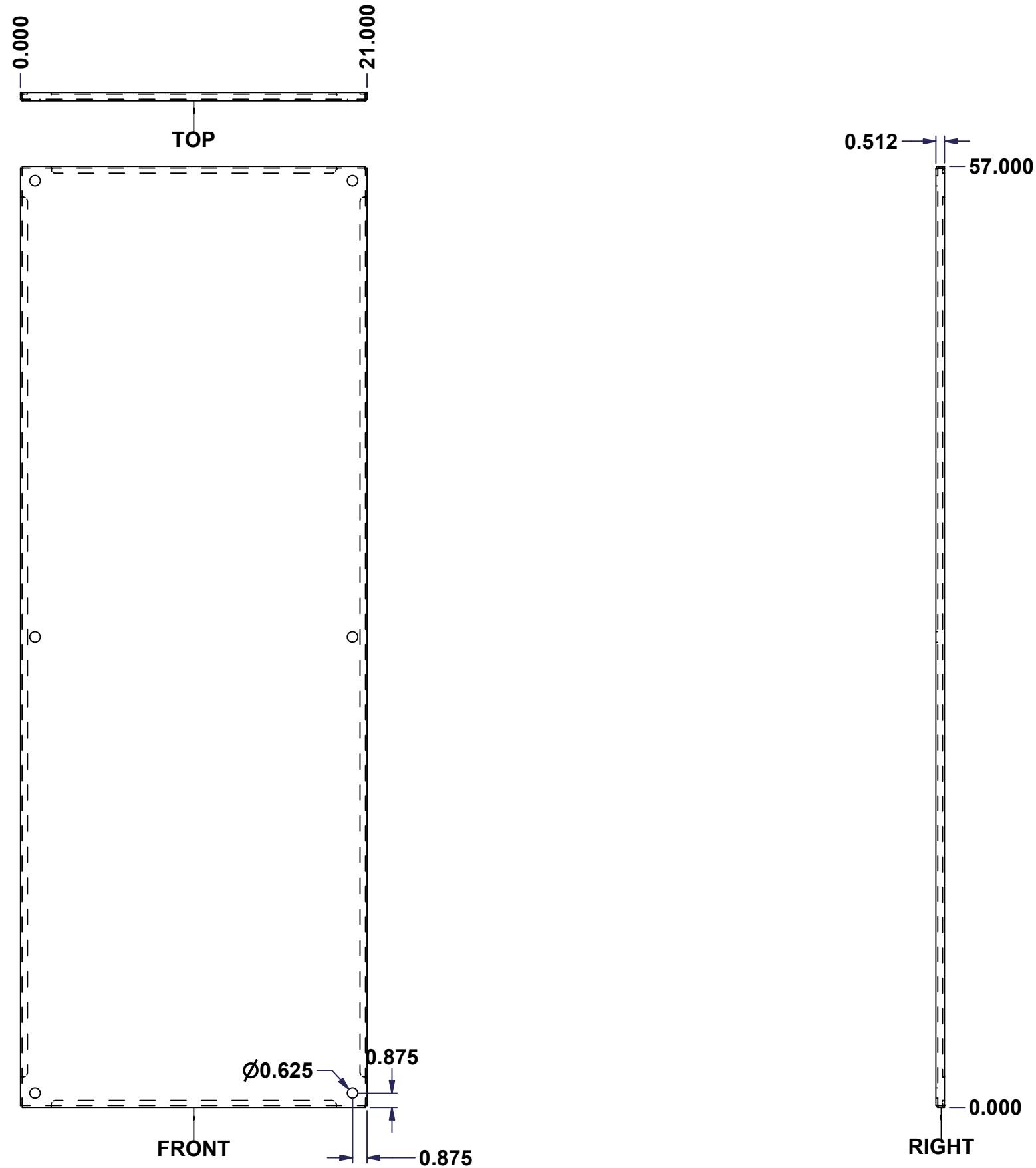

| No. | Revisions | Date | By/Par |
|-----|-----------|------|--------|
|     |           |      |        |
|     |           |      |        |
|     |           |      |        |
|     |           |      |        |
|     |           |      |        |

Isometric View

|  |  |  |             |
|--|--|--|-------------|
|  |  | Flatness<br>Aplatissement<br>Max 3.0mm |             |
| Tél: (450) 979-4373<br>Fax: (450) 979-4626<br><a href="http://www.exmweb.com">www.exmweb.com</a> |  | Projection<br>                         |             |
| Customer Client  |  | Date                                   |             |
| Drawn By / Dessiné Par: BoxCad: nickz  |  | Date: 01/03/2017                       |             |
| Material / Matière: 12 Ga Galvanized (2.5mm)   |  |  |             |
| Color / Couleur: See Part List   |  | Finish / Fini: See Part List           |             |
| Description: 885SP 60" x 24" Inner Panel Part  |  |  | Detail Rev. |
| Part Number / Numéro Pièce: <b>885SP6024G</b>  |  |  | Rev. 1      |

| Qty | Part Number  | Rev | Description                      | Material                 | Color     | Finish     |
|-----|--------------|-----|----------------------------------|--------------------------|-----------|------------|
| 1   | 885SP6024G-P | 0   | 885SP 60" x 24" Inner Panel Part | 12 Ga Galvanized (2.5mm) | Unpainted | Galvanized |

Parts List