

This drawing is confidential and must not be reproduced or used without the consent of EXM

Ce dessin est confidentiel et ne doit pas être reproduit ou utilisé sans le consentement de EXM

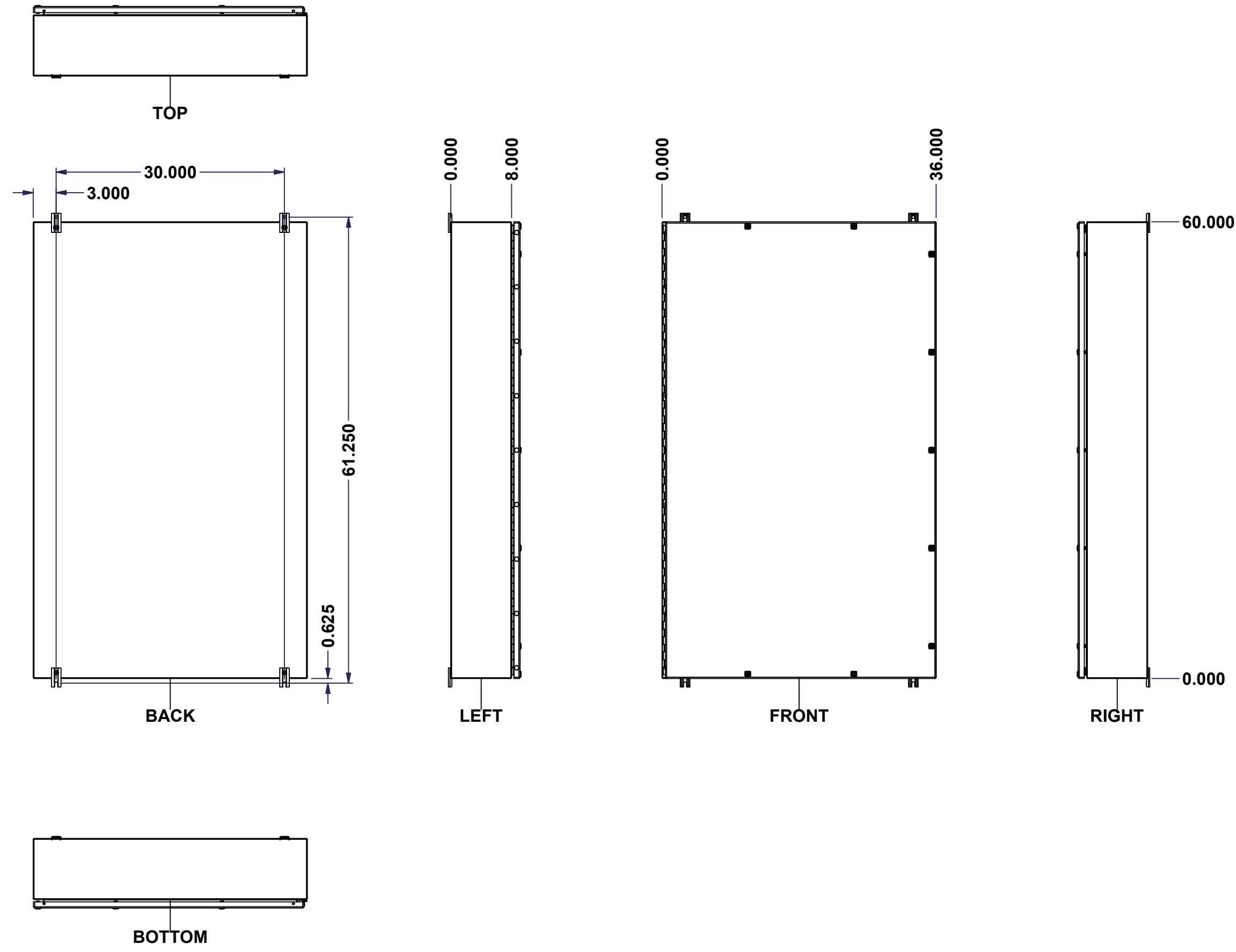

No.	Revisions	Date	By/Par

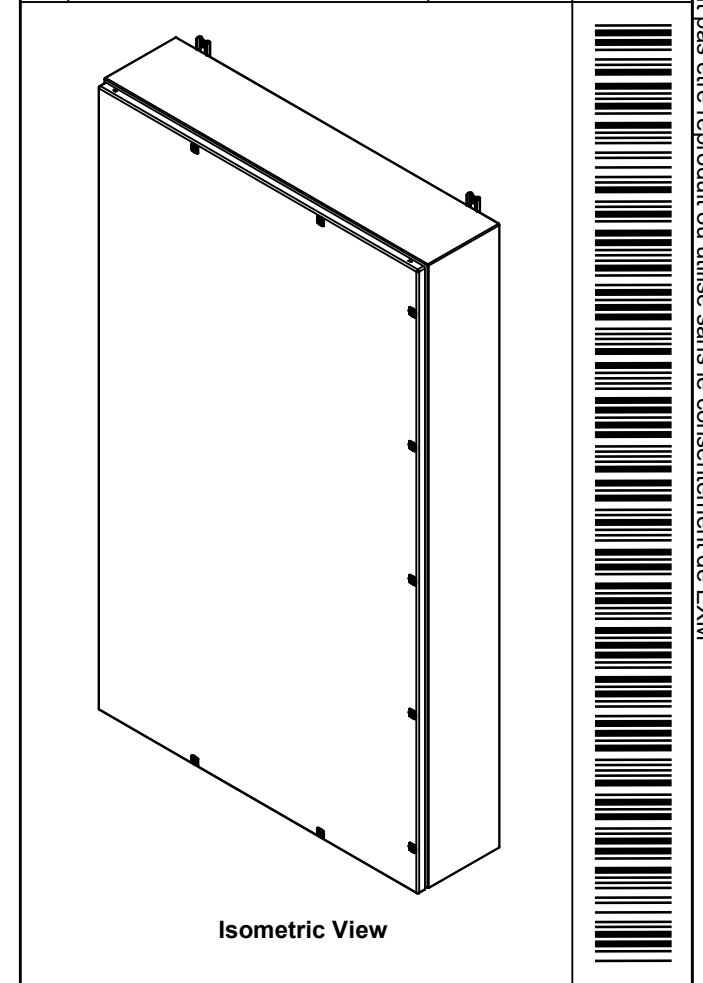

Tél: (450) 979-4373 Fax: (450) 979-4626 www.exmweb.com		Flatness Aplatissement Max 3.0mm Projection
Customer Client	Date	
Drawn By Dessiné Par	BoxCad: BoxCad	Date 09-Feb-25
Material Matière	14 Ga Cold Rolled A1008 CS Type B (1.7mm)	
Color Couleur	Asa-61 Grey	Finish Fini Smooth
Description	Detail Rev.	
5412ESEL 60" x 36" x 8" Assembly		
Part Number Numéro Pièce	Rev. 0	1 / 16

SEE BILL OF MATERIAL ON LAST PAGE

5412ESEL603608TH

This drawing is confidential and must not be reproduced or used without the consent of EXM

Ce dessin est confidentiel et ne doit pas être reproduit ou utilisé sans le consentement de EXM

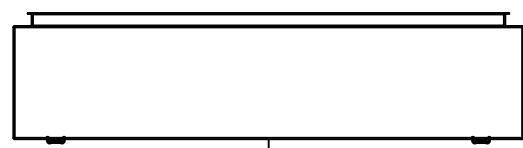

TOP

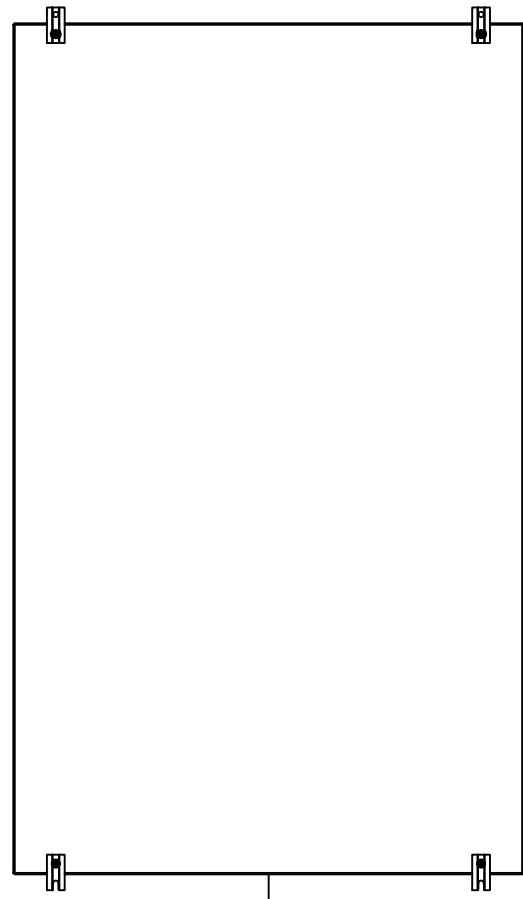

BACK

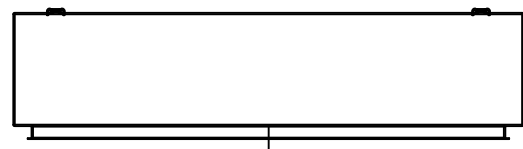

BOTTOM

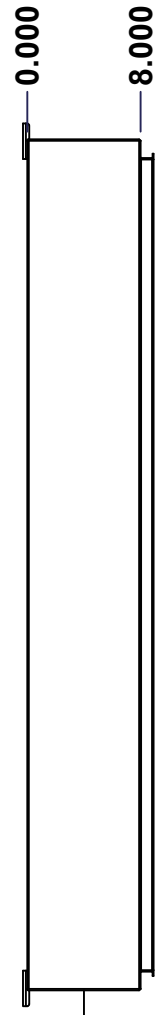

LEFT

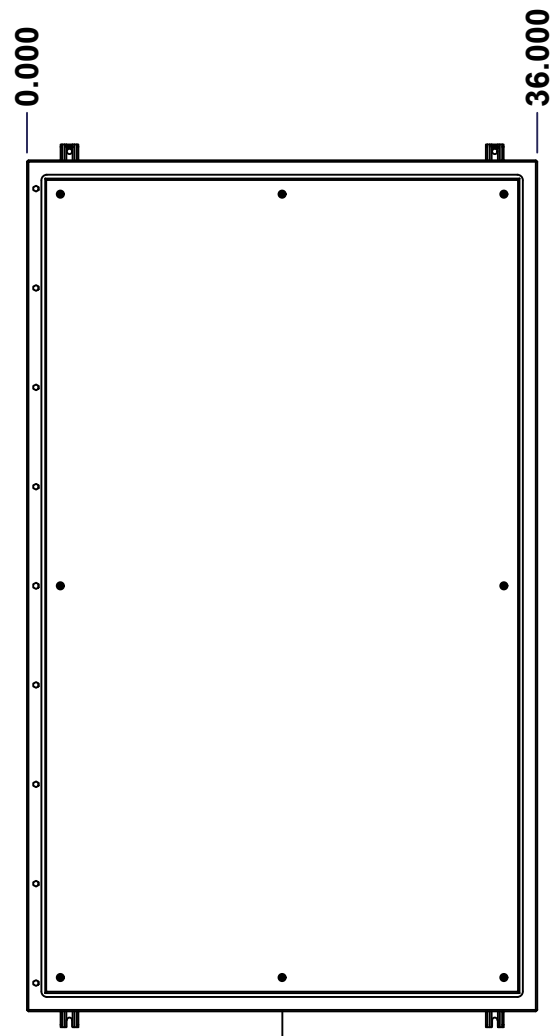

FRONT

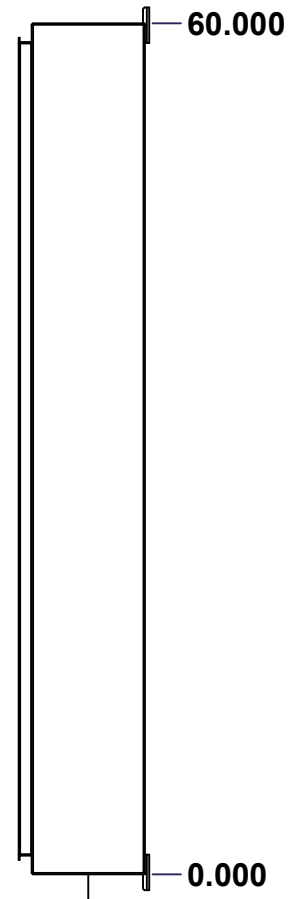

RIGHT

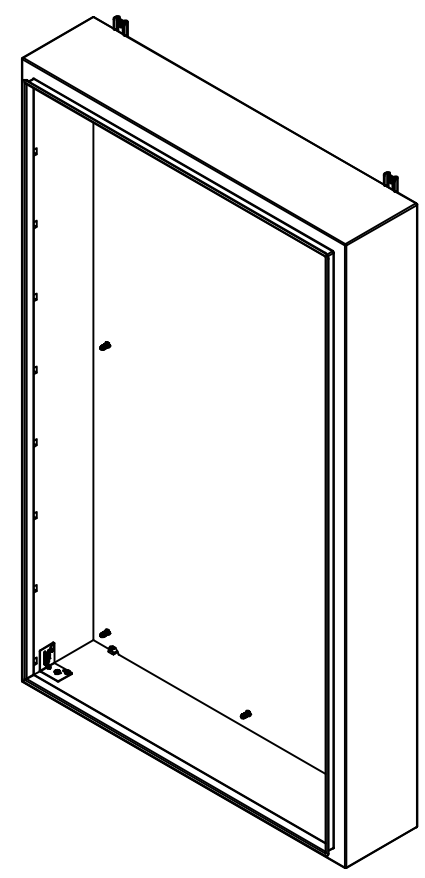

Isometric View

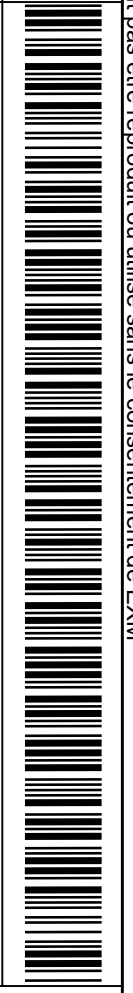

No.	Revisions	Date	By/Par

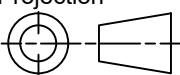
 Tél: (450) 979-4373 Fax: (450) 979-4626 www.exmweb.com		Flatness Aplatissement Max 3.0mm Projection 
Customer Client	Date	
Drawn By Dessiné Par	BoxCad: BoxCad	Date 09-Feb-25
Material Matière	14 Ga Cold Rolled A1008 CS Type B (1.7mm)	
Color Couleur	Asa-61 Grey	Finish Fini Smooth
Description	Detail Rev.	
5412ESEL 60" x 36" x 8" Body		
Part Number Numéro Pièce	Rev. 0	3 / 16

SEE BILL OF MATERIAL ON LAST PAGE

5412ESEL603608THB

This drawing is confidential and must not be reproduced or used without the consent of EXM

Ce dessin est confidentiel et ne doit pas être reproduit ou utilisé sans le consentement de EXM

STANDARD FEATURES ARE NOT LISTED IN THIS HOLE TABLE			
HOLE TABLE - TOP VIEW (CUSTOM FEATURE ONLY)			
CUT-OUT	XDIM	YDIM	DESCRIPTION
1	2.000	6.000	INSUL. STUD M6 x 18mm (Inside)
2	34.000	6.000	INSUL. STUD M6 x 18mm (Inside)

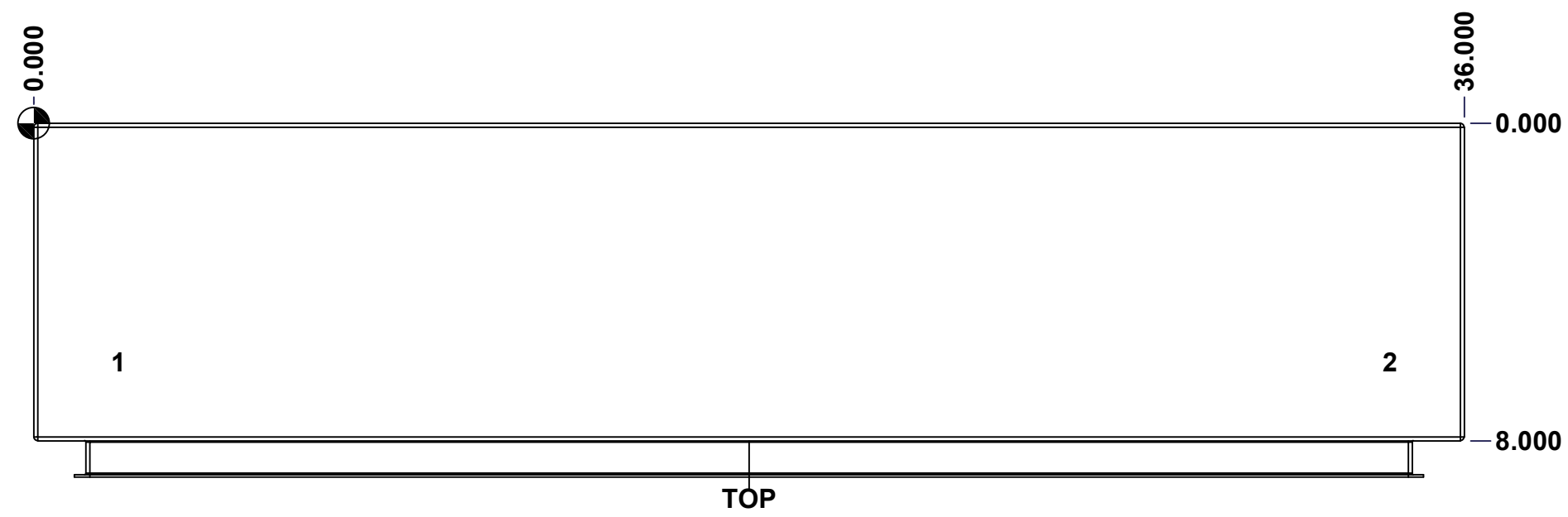

	Description	Status
	5412ESEL 60" x 36" x 8" Body	(NULL)
	Part Number Numéro Pièce	Rev.
	5412ESEL603608THB	0
		4
		16

This drawing is confidential and must not be reproduced or used without the consent of EXM

Ce dessin est confidentiel et ne doit pas être reproduit ou utilisé sans le consentement de EXM

STANDARD FEATURES ARE NOT LISTED IN THIS HOLE TABLE			
HOLE TABLE - BOTTOM VIEW (CUSTOM FEATURE ONLY)			
CUT-OUT	XDIM	YDIM	DESCRIPTION
1	2.000	6.000	INSUL. STUD M6 x 18mm (Inside)
2	34.000	6.000	INSUL. STUD M6 x 18mm (Inside)

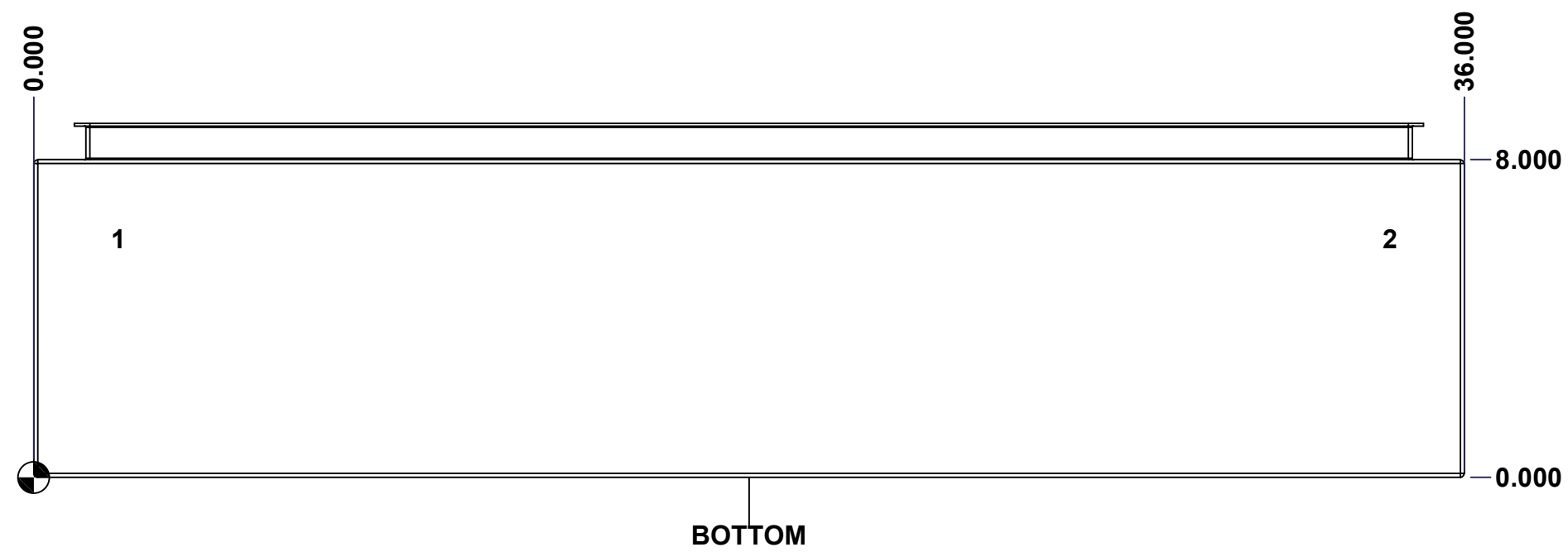

	Description		Status
	5412ESEL 60" x 36" x 8" Body		(NULL)
Part Number Numéro Pièce		Rev.	5
5412ESEL603608THB		0	16

This drawing is confidential and must not be reproduced or used without the consent of EXM

Ce dessin est confidentiel et ne doit pas être reproduit ou utilisé sans le consentement de EXM

STANDARD FEATURES ARE NOT LISTED IN THIS HOLE TABLE

HOLE TABLE - BACK VIEW (CUSTOM FEATURE ONLY)

CUT-OUT	XDIM	YDIM	DESCRIPTION
1	2.375	2.375	IP STUD M8 x 35mm (Inside)
2	2.375	57.625	IP STUD M8 x 35mm (Inside)
3	33.625	57.625	IP STUD M8 x 35mm (Inside)
4	33.625	2.375	IP STUD M8 x 35mm (Inside)
5	2.375	30.000	IP STUD M8 x 35mm (Inside)
6	33.625	30.000	IP STUD M8 x 35mm (Inside)
7	18.000	2.375	IP STUD M8 x 35mm (Inside)
8	18.000	57.625	IP STUD M8 x 35mm (Inside)

9	33.000	0.000	FOOT 885 ESMF3_OPEN
10	3.000	0.000	FOOT 885 ESMF3_OPEN
11	33.000	60.000	FOOT 885 ESMF3_CLOSE
12	3.000	60.000	FOOT 885 ESMF3_CLOSE

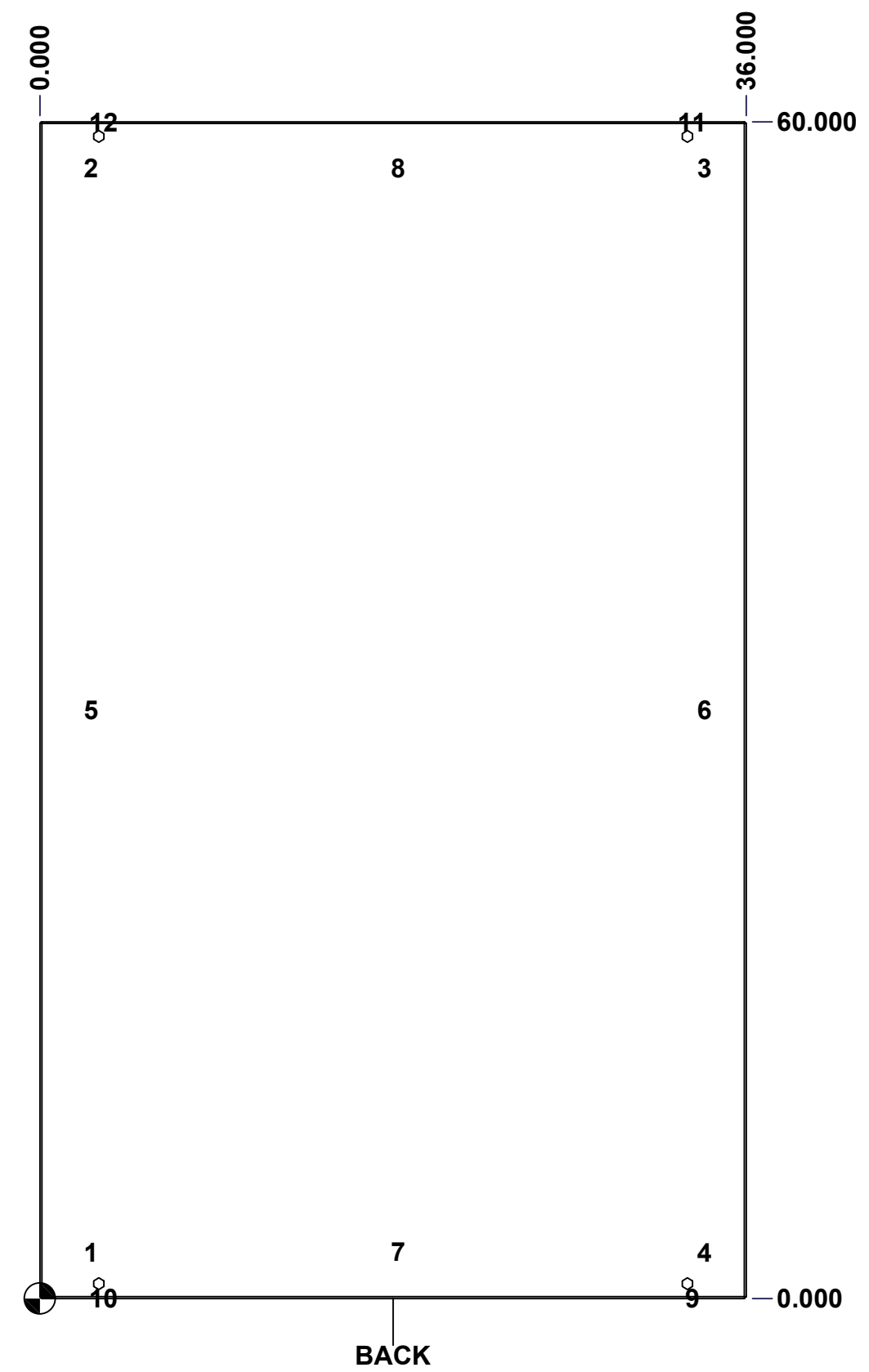

	Description		Status
	5412ESEL 60" x 36" x 8" Body		(NULL)
Part Number Numéro Pièce		Rev.	6
5412ESEL603608THB		0	16

This drawing is confidential and must not be reproduced or used without the consent of EXM

Ce dessin est confidentiel et ne doit pas être reproduit ou utilisé sans le consentement de EXM

No.	Revisions	Date	By/Par

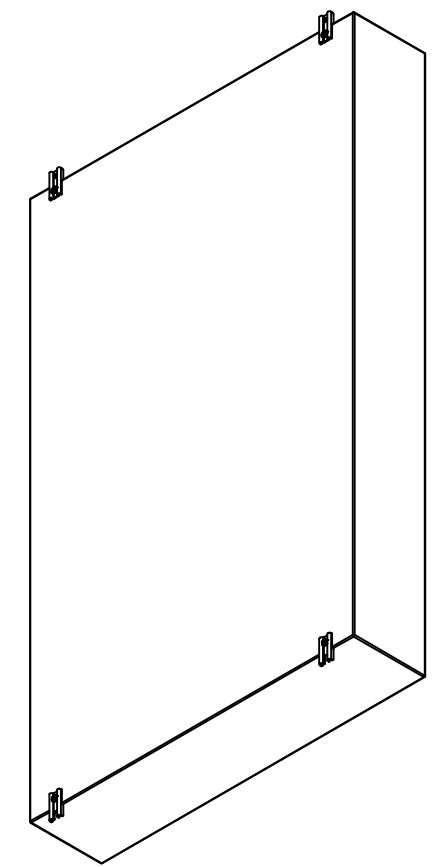

Isometric View



1	885 ESMF3	0	885 ESMF3 Mounting Foot Kit
4	RIVET_NUT_M10_FH_CE	0	Rivet Nut M10 (Low Profile Close End)
1	STK-K-70554	3	5412 ESTH Accessory Kit
1	5412ESEL603608THI-RS	0	5412ESEL 60" x 36" Right Insulation
1	5412ESEL603608THI-LS	0	5412ESEL 60" x 36" Left Insulation
1	5412ESEL603608THI-BT	0	5412ESEL 60" x 36"Bottom Insulation
1	5412ESEL603608THI-TP	0	5412ESEL 60" x 36"Top Insulation
1	5412ESEL603608THI-B	0	5412ESEL 60" x 36" Back Insulation
4	STK-Q-16055	1	M6 x 18mm Stud (No Paint Cap Required)
1	STK-P-02400S	0	Powder Paint (Asa-61 Grey / Smooth)
8	STK-Q-16005	0	Stud M8 x 35mm Steel
1	5412ESEL603608THB-P	0	5412ESEL 60" x 36" x 8" Body Part

Qty	Part Number	Rev	Description
Parts List			

Tél: (450) 979-4373 Fax: (450) 979-4626 www.exmweb.com		Flatness Aplatissement Max 3.0mm
Projection 		Date 09-Feb-25
Customer Client	BoxCad: BoxCad	Date
Drawn By Dessiné Par	BoxCad: BoxCad	Date
Material Matière	14 Ga Cold Rolled A1008 CS Type B (1.7mm)	
Color Couleur	Asa-61 Grey	Finish Fini Smooth
Description	5412ESEL 60" x 36" x 8" Body	
Part Number Numéro Pièce	Rev.	7
5412ESEL603608THB	0	16

This drawing is confidential and must not be reproduced or used without the consent of EXM

Ce dessin est confidentiel et ne doit pas être reproduit ou utilisé sans le consentement de EXM



TOP

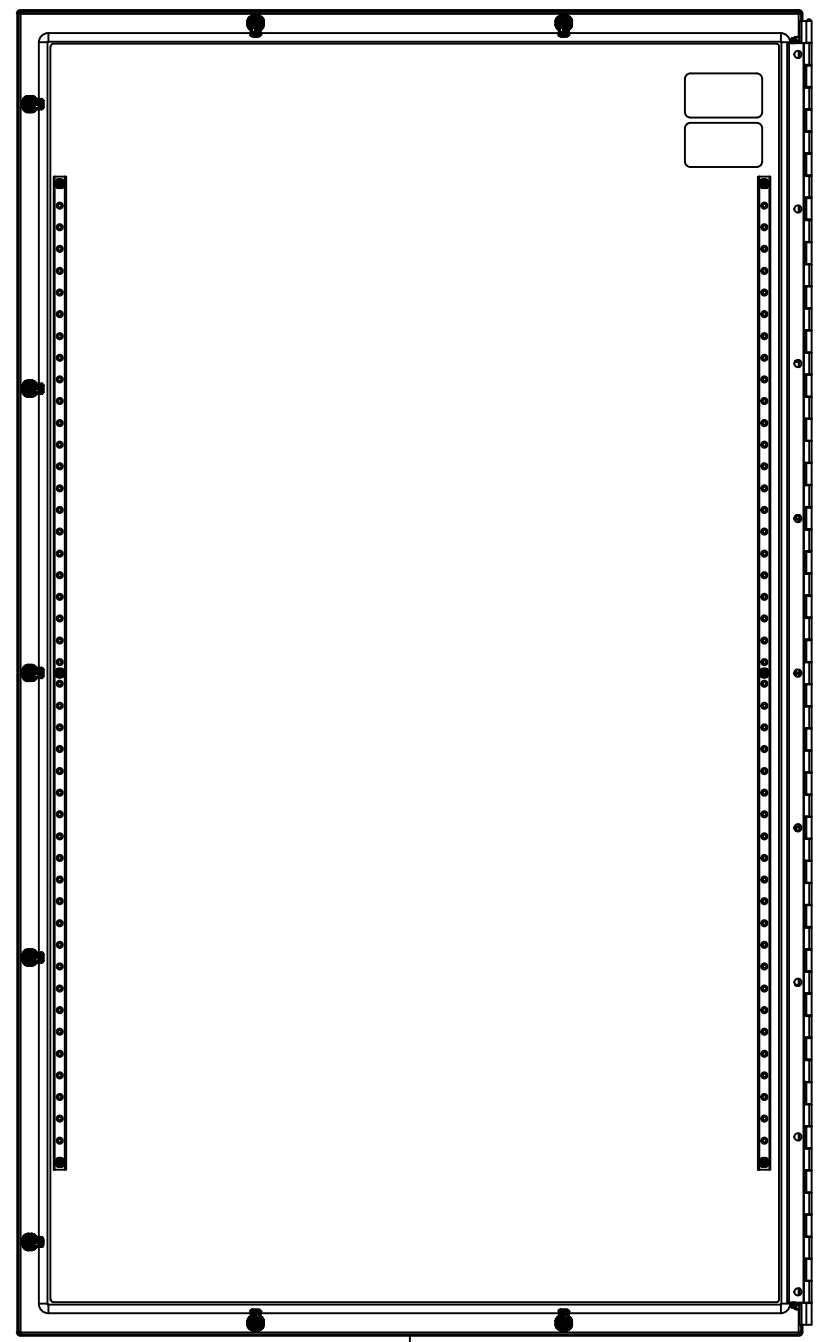

BACK



BOTTOM

0.000
0.800

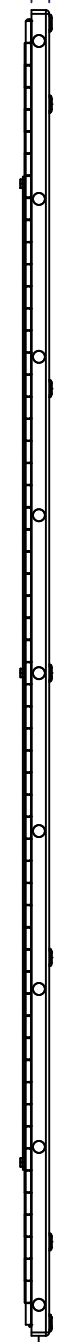

LEFT

0.000

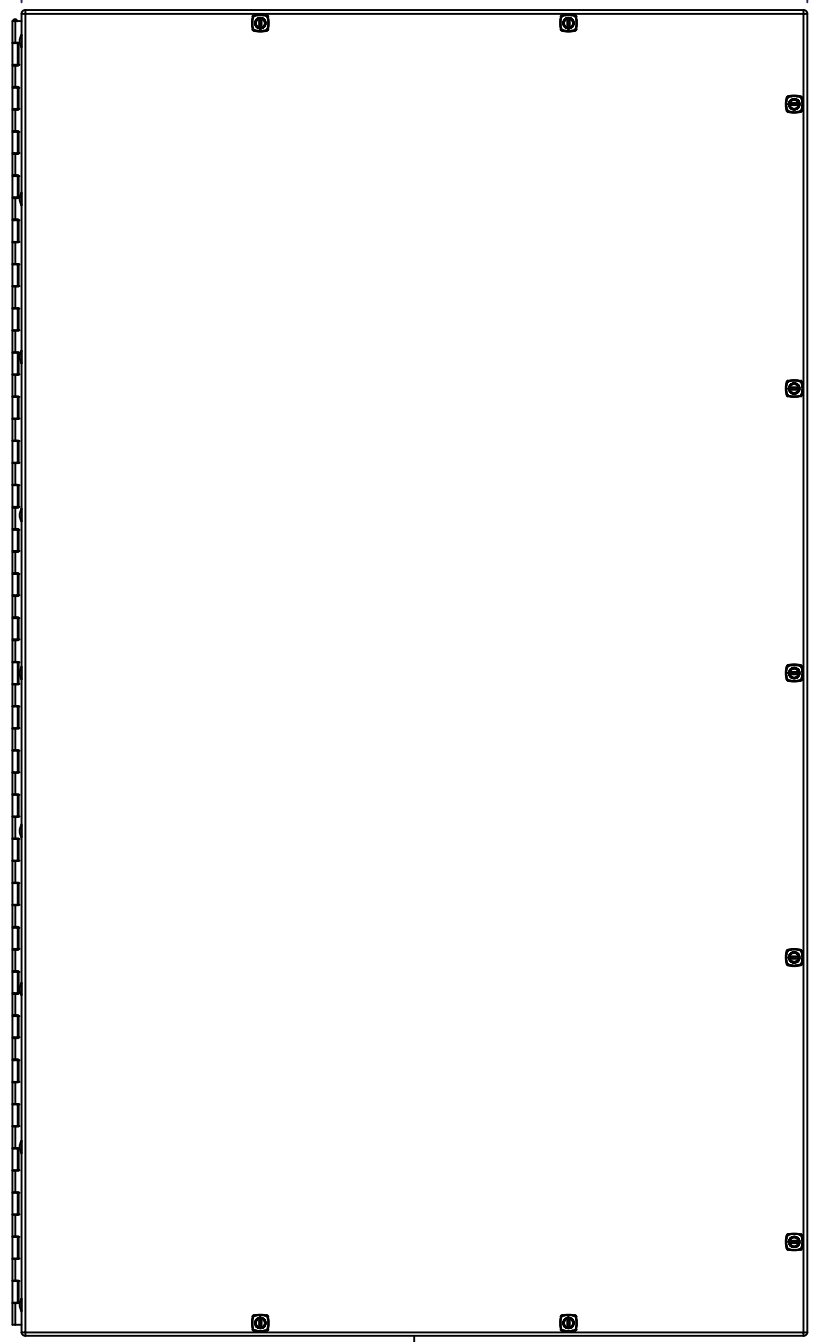

FRONT

35.548

60.000



RIGHT

0.000

No.	Revisions	Date	By/Par

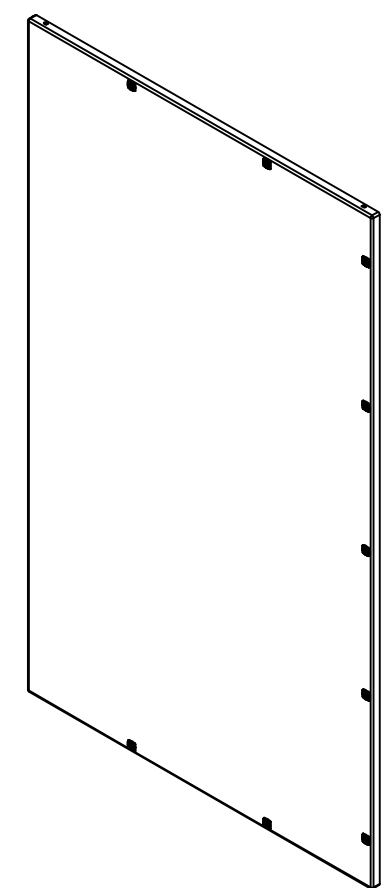

Isometric View

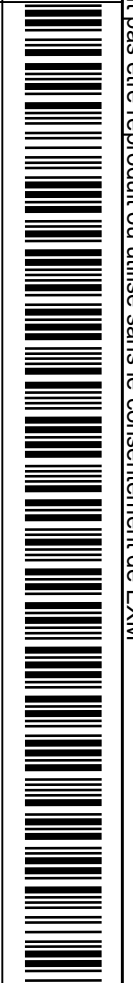

Tél: (450) 979-4373
Fax: (450) 979-4626
www.exmweb.com

Flatness
Aplatissement
Max 3.0mm
Projection

Customer Client	Date
Drawn By Dessiné Par BoxCad: BoxCad	Date 09-Feb-25
Material Matière 14 Ga Cold Rolled A1008 CS Type B (1.7mm)	

Color Couleur Asa-61 Grey	Finish Fini Smooth
------------------------------	-----------------------

Description 5412ESEL 60" x 36" Cover	Detail Rev.
---	-------------

Part Number Numéro Pièce 5412ESEL603608THC	Rev. 0	8
--	---------------	---

SEE BILL OF MATERIAL ON LAST PAGE

This drawing is confidential and must not be reproduced or used without the consent of EXM

Ce dessin est confidentiel et ne doit pas être reproduit ou utilisé sans le consentement de EXM

STANDARD FEATURES ARE NOT LISTED IN THIS HOLE TABLE

HOLE TABLE - FRONT VIEW (CUSTOM FEATURE ONLY)

CUT-OUT	XDIM	YDIM	DESCRIPTION
1	1.729	7.854	STUD M6 x 18mm (Inside)
2	1.729	52.146	STUD M6 x 18mm (Inside)
3	1.729	30.000	STUD M6 x 18mm (Inside)
4	33.609	7.854	STUD M6 x 18mm (Inside)
5	33.609	52.146	STUD M6 x 18mm (Inside)
6	33.609	30.000	STUD M6 x 18mm (Inside)

7	34.968	55.750	LOCK 880 SCQ5-SL @ 180.0°
8	34.968	17.125	LOCK 880 SCQ5-SL @ 180.0°
9	34.968	30.000	LOCK 880 SCQ5-SL @ 180.0°
10	10.800	59.420	LOCK 880 SCQ5-SL @ 270.0°
11	24.748	59.420	LOCK 880 SCQ5-SL @ 270.0°
12	10.800	0.580	LOCK 880 SCQ5-SL @ 90.0°
13	24.748	0.580	LOCK 880 SCQ5-SL @ 90.0°
14	34.968	42.875	LOCK 880 SCQ5-SL @ 180.0°
15	34.968	4.250	LOCK 880 SCQ5-SL @ 180.0°

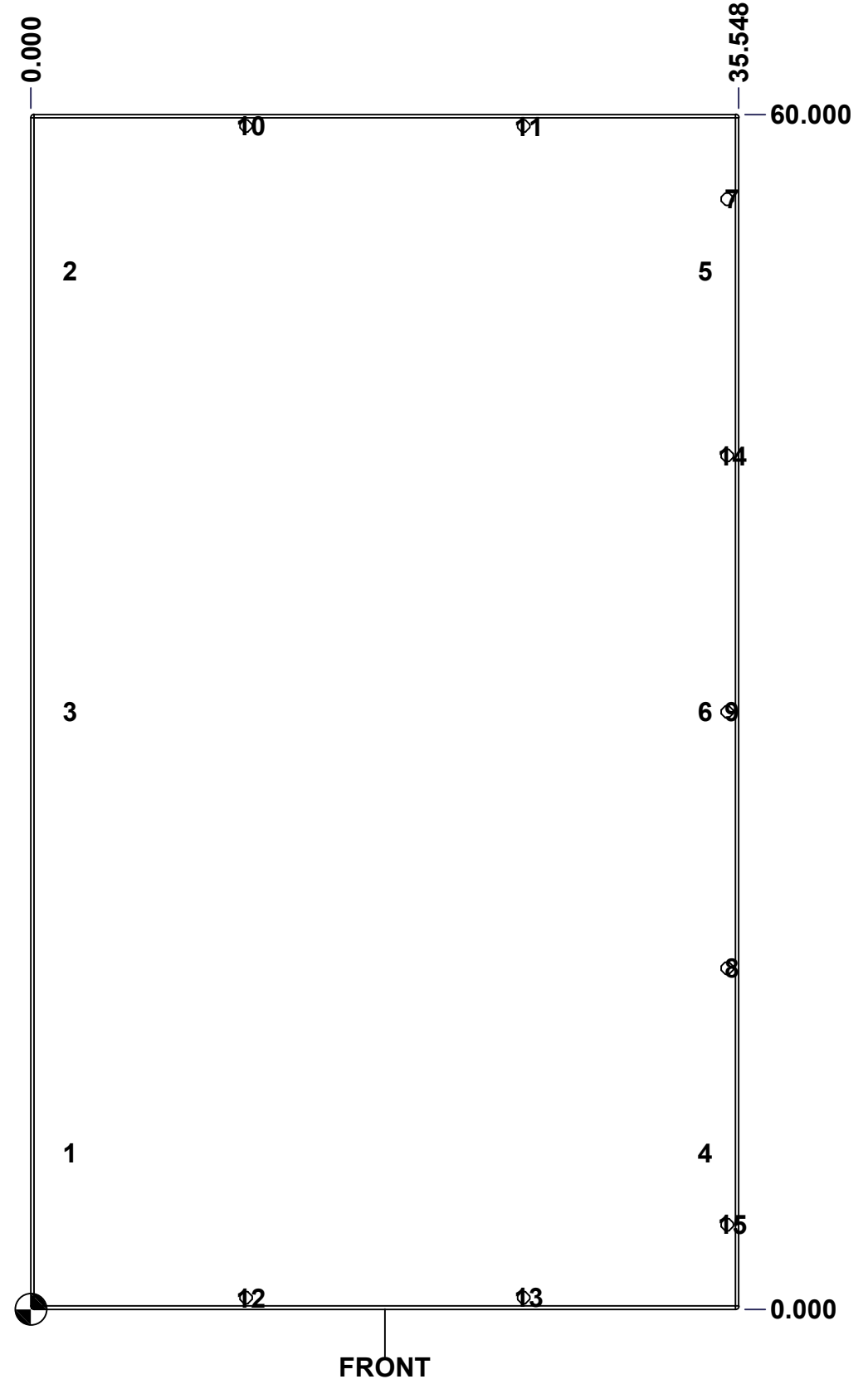

	Description	Status
	5412ESEL 60" x 36" Cover	(NULL)
Part Number Numéro Pièce 5412ESEL603608THC	Rev.	9
	0	16

This drawing is confidential and must not be reproduced or used without the consent of EXM

Ce dessin est confidentiel et ne doit pas être reproduit ou utilisé sans le consentement de EXM

No.	Revisions	Date	By/Par

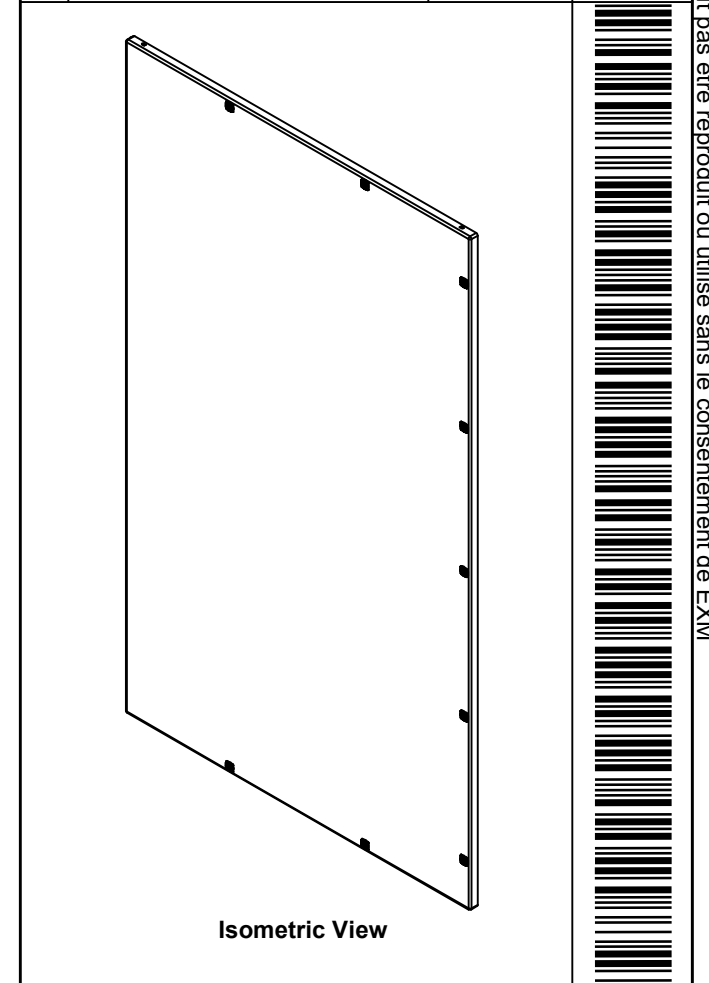

2	STK-S-00100	0	3.5" x 2" Silver Milar Flexcon Sticker
6	STK-Q-07250	2	M6 x 16mm Collar Nut
2	STK-Q-46020-48	5	5412 ES Vertical Door Stiffener 48"
1	5412ESEL603608THI-C	0	5412ESEL 60" x 36" Cover Insulation
1	STK-P-02400S	0	Powder Paint (Asa-61 Grey / Smooth)
6	STK-Q-16055	1	M6 x 18mm Stud (No Paint Cap Required)
9	STK-Q-00260	1	M6 x 13mm Carriage Bolt
1	5412ESEL603608THHP-P	0	Piano Hinge Pin (Length= 59.181")
1	5412ESEL603608THH1-P	0	5412ESEL 60" x 36" Piano Hinge Part
1	5412ESEL603608THH2-P	0	5412ESEL 60" x 36" Piano Hinge Part
1	5412ESEL603608THG	0	5412ESEL 60" x 36" Cover Gasket Part
1	5412ESEL603608THC-P	0	5412ESEL 60" x 36" Cover Part
9	880 SCQ5-SL		5412 ESEL 1/4 Turn Lock
9	STK-Q-07225	0	M6 Stainless Steel Nylon Insert Lock Nut
QTY	Part Number	Rev	Description
Parts List			

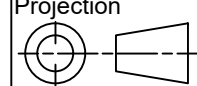
 Tél: (450) 979-4373 Fax: (450) 979-4626 www.exmweb.com		Flatness Aplatissement Max 3.0mm
Customer Client		Projection 
Drawn By Dessiné Par BoxCad: BoxCad		Date 09-Feb-25
Material Matière 14 Ga Cold Rolled A1008 CS Type B (1.7mm)		
Color Couleur Asa-61 Grey	Finish Fini Smooth	
Description 5412ESEL 60" x 36" Cover		Detail Rev.
Part Number Numéro Pièce 5412ESEL603608THC		Rev. 10 0 16

This drawing is confidential and must not be reproduced or used without the consent of EXM

Ce dessin est confidentiel et ne doit pas être reproduit ou utilisé sans le consentement de EXM

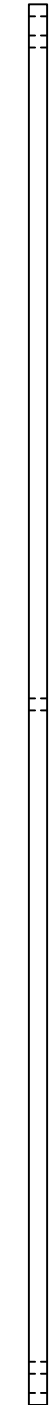
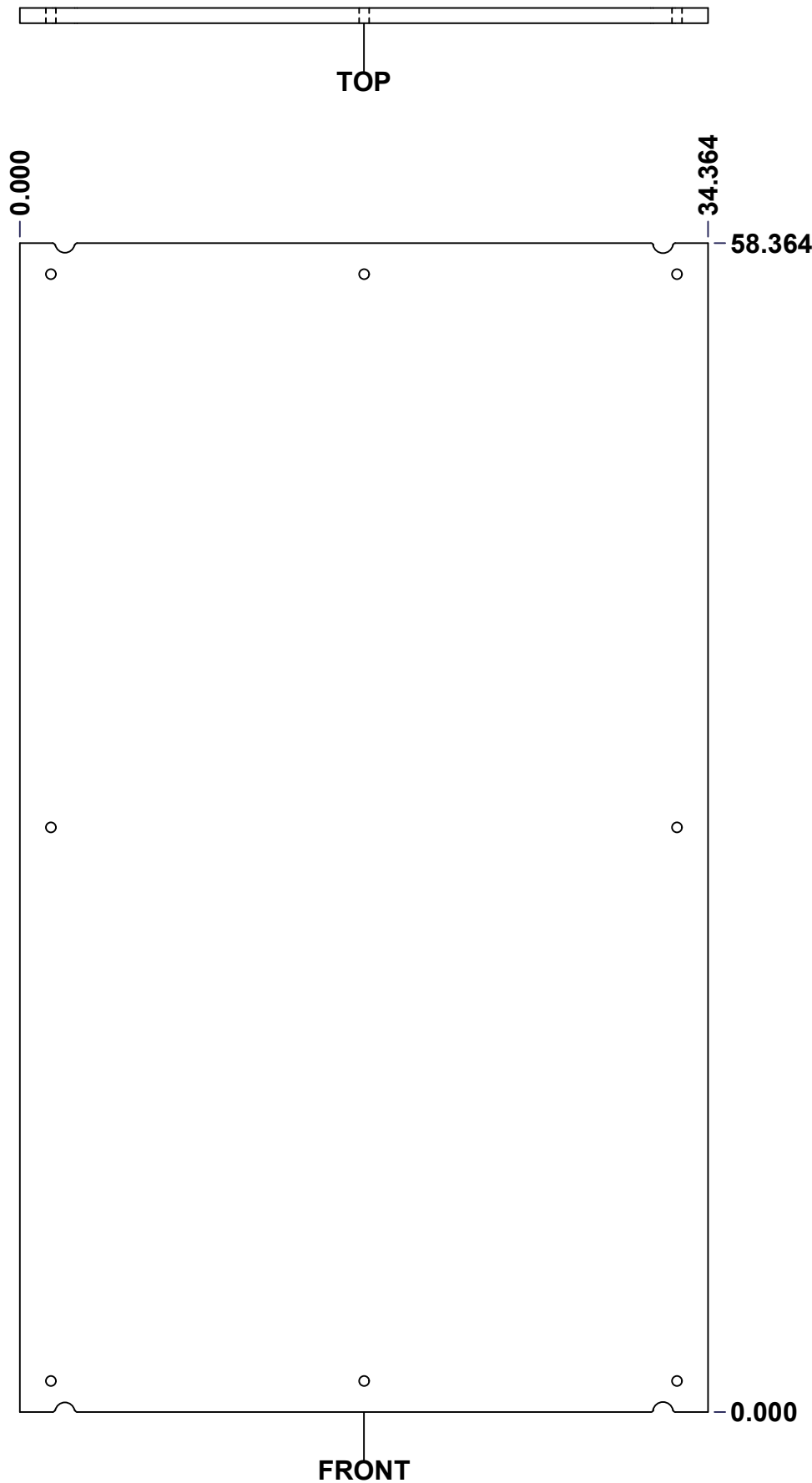

No.	Revisions	Date	By/Par

Isometric View

		Flatness Aplatissement Max 3.0mm	
Tél: (450) 979-4373 Fax: (450) 979-4626 www.exmweb.com		Projection 	
Customer Client		Date	
Drawn By Dessiné Par BoxCad: Patrick Deschenes		Date 23-Jan-07	
Material Matière Polyisocyanurate			
Color Couleur Aluminum	Finish Fini N/A		
Description 5412ESEL 60" x 36" Back Insulation			Detail Rev.
Part Number Numéro Pièce 5412ESEL603608THI-B		Rev. 0	11 / 16

SEE BILL OF MATERIAL ON LAST PAGE

This drawing is confidential and must not be reproduced or used without the consent of EXM

Ce dessin est confidentiel et ne doit pas être reproduit ou utilisé sans le consentement de EXM

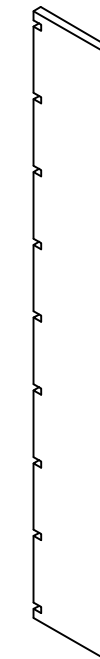
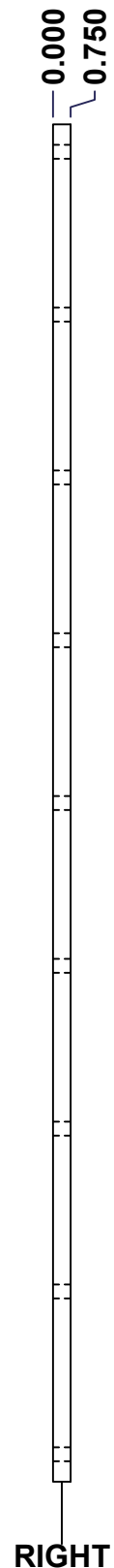
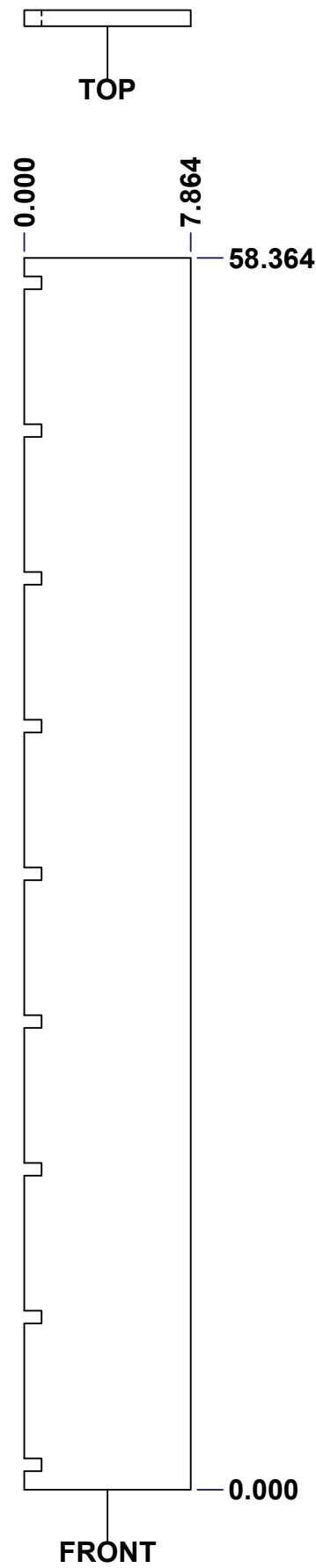

Isometric View

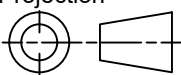

No.	Revisions	Date	By/Par

 Tél: (450) 979-4373 Fax: (450) 979-4626 www.exmweb.com		Flatness Aplatissement Max 3.0mm
Projection 		Date 23-Jan-07
Customer Client	Date	
Drawn By / Dessiné Par: BoxCad: Patrick Deschenes	Date: 23-Jan-07	
Material / Matière: Polyisocyanurate	Date	
Color / Couleur: Aluminum	Finish / Fini: N/A	Date
Description: 5412ESEL 60" x 36" Left Insulation		Detail Rev.
Part Number / Numéro Pièce: 5412ESEL603608THI-LS	Rev. 0	12 / 16

SEE BILL OF MATERIAL ON LAST PAGE

This drawing is confidential and must not be reproduced or used without the consent of EXM

Ce dessin est confidentiel et ne doit pas être reproduit ou utilisé sans le consentement de EXM

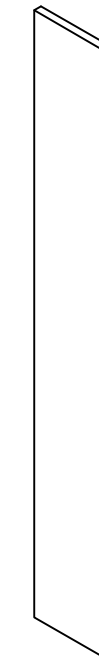
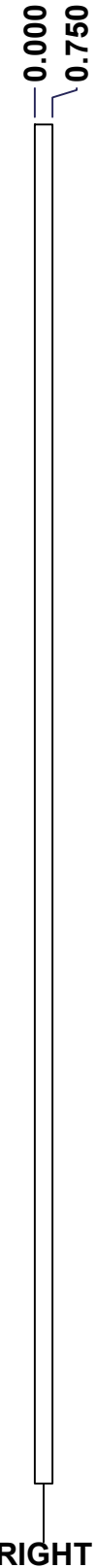
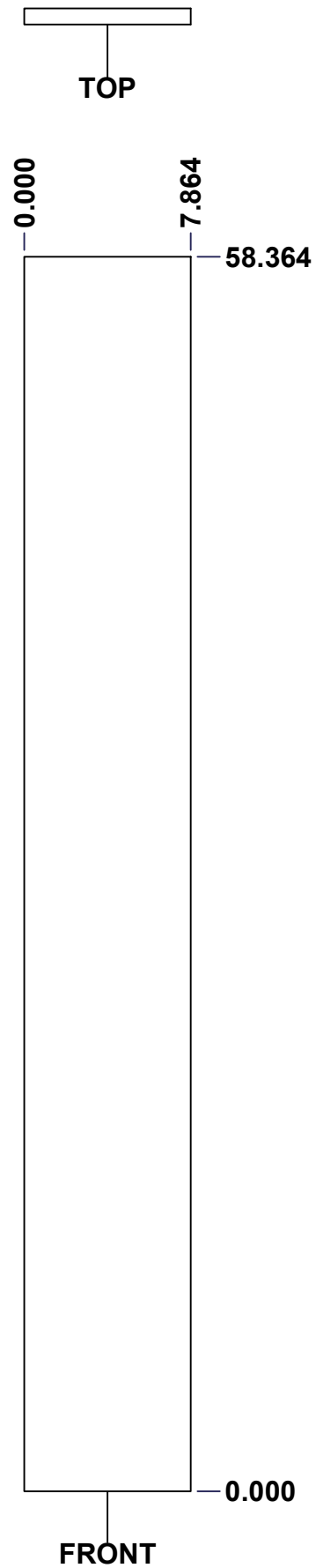

Isometric View

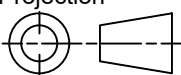

No.	Revisions	Date	By/Par

 Tél: (450) 979-4373 Fax: (450) 979-4626 www.exmweb.com		Flatness Aplatissement Max 3.0mm
Projection 		Date 23-Jan-07
Customer Client	Date	
Drawn By / Dessiné Par: BoxCad: Patrick Deschenes	Date: 23-Jan-07	
Material / Matière: Polyisocyanurate		
Color / Couleur: Aluminum	Finish / Fini: N/A	
Description: 5412ESEL 60" x 36" Right Insulation		Detail Rev.
Part Number / Numéro Pièce: 5412ESEL603608THI-RS	Rev. 0	13 / 16

SEE BILL OF MATERIAL ON LAST PAGE

This drawing is confidential and must not be reproduced or used without the consent of EXM

Ce dessin est confidentiel et ne doit pas être reproduit ou utilisé sans le consentement de EXM

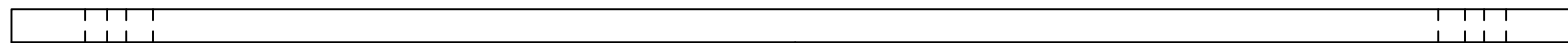

TOP

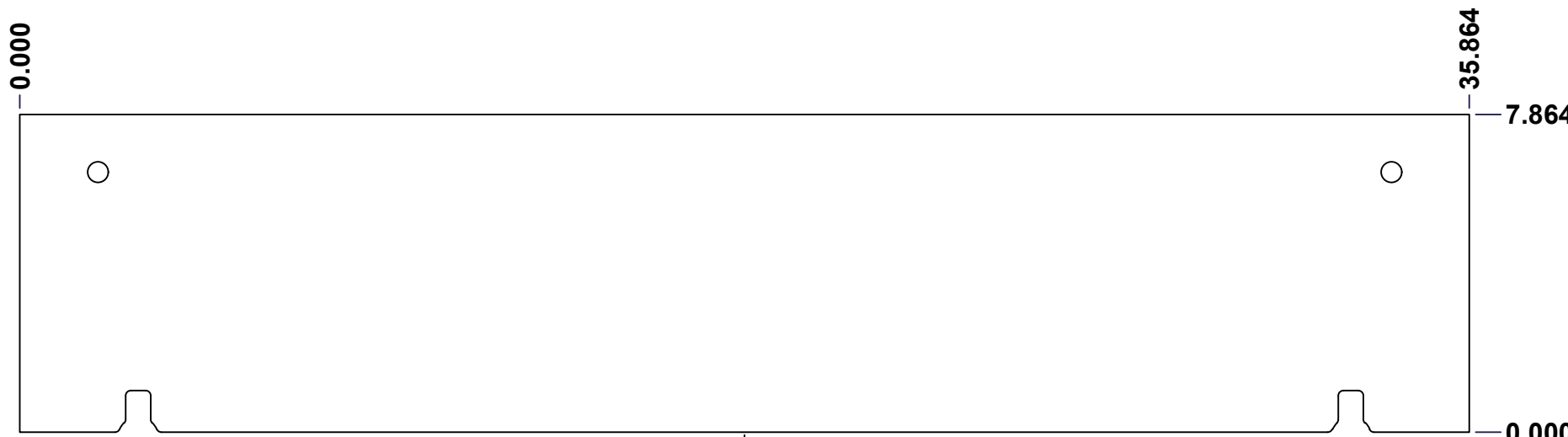

FRONT

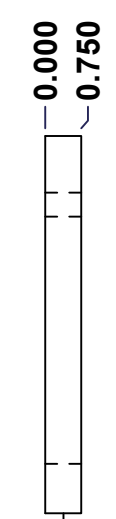

RIGHT

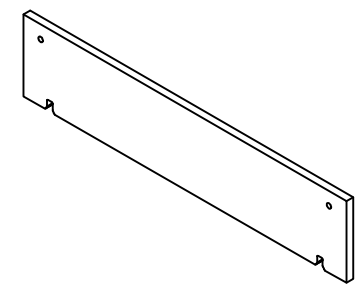

Isometric View

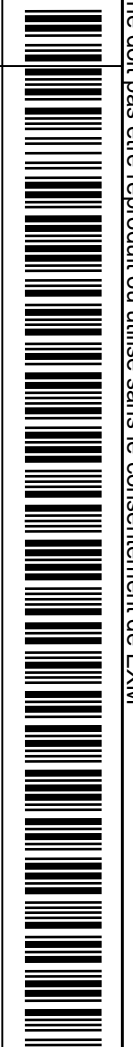

No.	Revisions	Date	By/Par

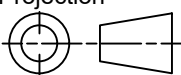
 Tél: (450) 979-4373 Fax: (450) 979-4626 www.exmweb.com		Flatness Aplatissement Max 3.0mm Projection 
Customer Client	Date	
Drawn By Dessiné Par	BoxCad: BoxCad	Date 4/3/2024
Material Matière	Polyisocyanurate	
Color Couleur	Aluminum	Finish Fini Smooth
Description	Detail Rev.	
5412ESEL 60" x 36"Top Insulation		
Part Number Numéro Pièce	Rev. 0	14 16

SEE BILL OF MATERIAL ON LAST PAGE

5412ESEL603608THI-TP

This drawing is confidential and must not be reproduced or used without the consent of EXM

Ce dessin est confidentiel et ne doit pas être reproduit ou utilisé sans le consentement de EXM

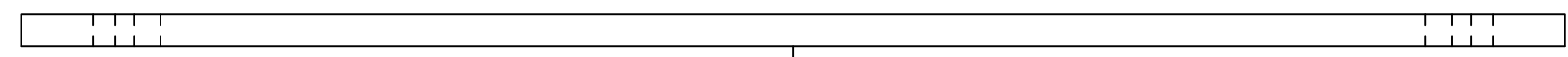

TOP

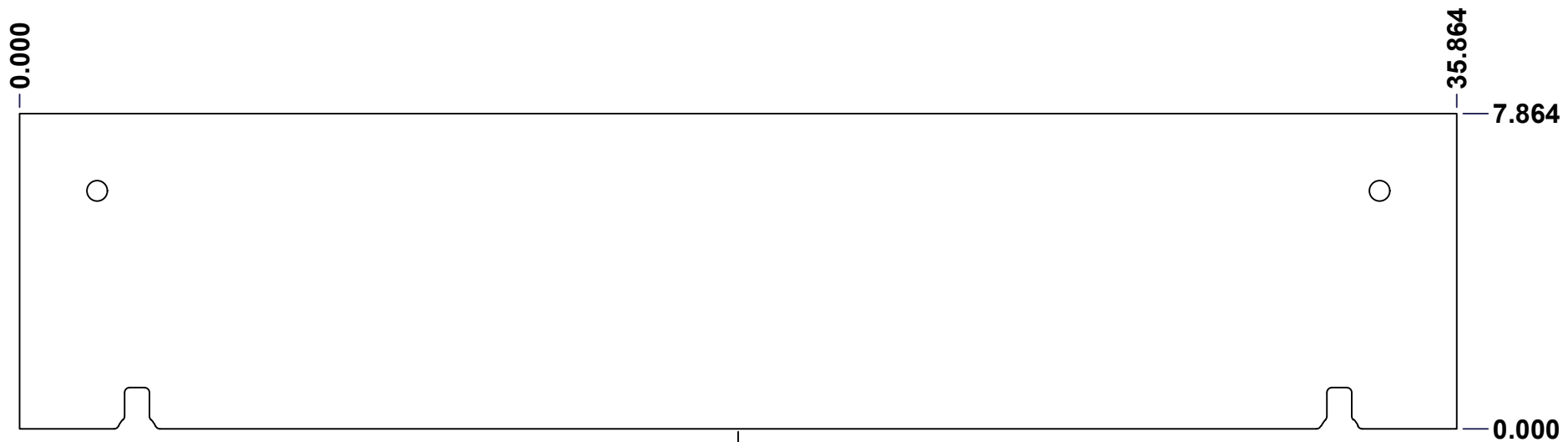

FRONT

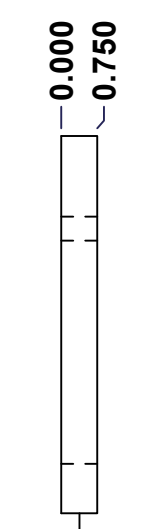

RIGHT

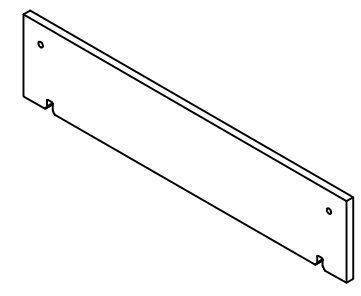

Isometric View

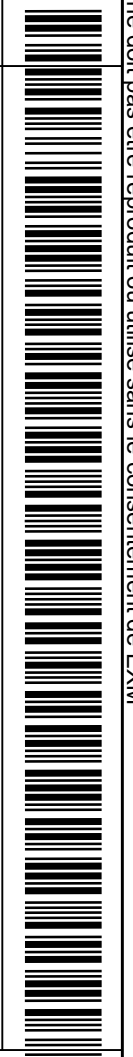

No.	Revisions	Date	By/Par

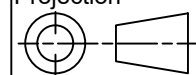
 Tél: (450) 979-4373 Fax: (450) 979-4626 www.exmweb.com		Flatness Aplatissement Max 3.0mm Projection 
Customer Client	Date	
Drawn By Dessiné Par	BoxCad: BoxCad	Date 4/3/2024
Material Matière	Polyisocyanurate	
Color Couleur	Aluminum	Finish Fini Smooth
Description	Detail Rev.	
5412ESEL 60" x 36"Bottom Insulation		
Part Number Numéro Pièce	Rev.	15
5412ESEL603608THI-BT	0	16

SEE BILL OF MATERIAL ON LAST PAGE

This drawing is confidential and must not be reproduced or used without the consent of EXM

Ce dessin est confidentiel et ne doit pas être reproduit ou utilisé sans le consentement de EXM

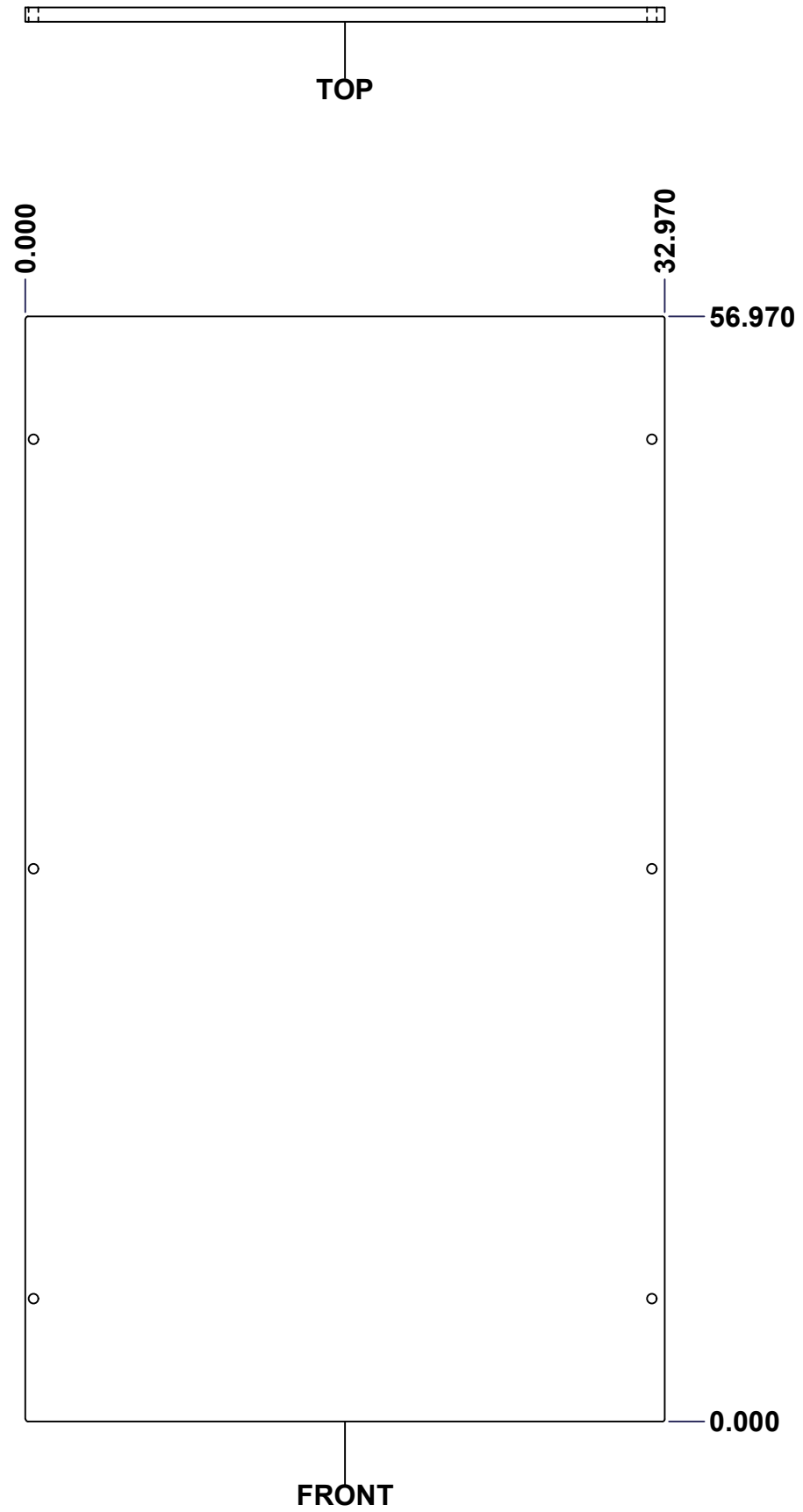

No.	Revisions	Date	By/Par

Isometric View

<p>Tél: (450) 979-4373 Fax: (450) 979-4626 www.exmweb.com</p>		Flatness Aplatissement	
		Max 3.0mm	
Customer Client		Date	
Drawn By Dessiné Par		Date	
Material Matière		Polyisocyanurate	
Color Couleur		Finish Fini	
Aluminum		N/A	
Description			Detail Rev.
5412ESEL 60" x 36" Cover Insulation			
Part Number Numéro Pièce		Rev.	
5412ESEL603608TH-C		0	16

SEE BILL OF MATERIAL ON LAST PAGE

This drawing is confidential and must not be reproduced or used without the consent of EXM

Ce dessin est confidentiel et ne doit pas être reproduit ou utilisé sans le consentement de EXM

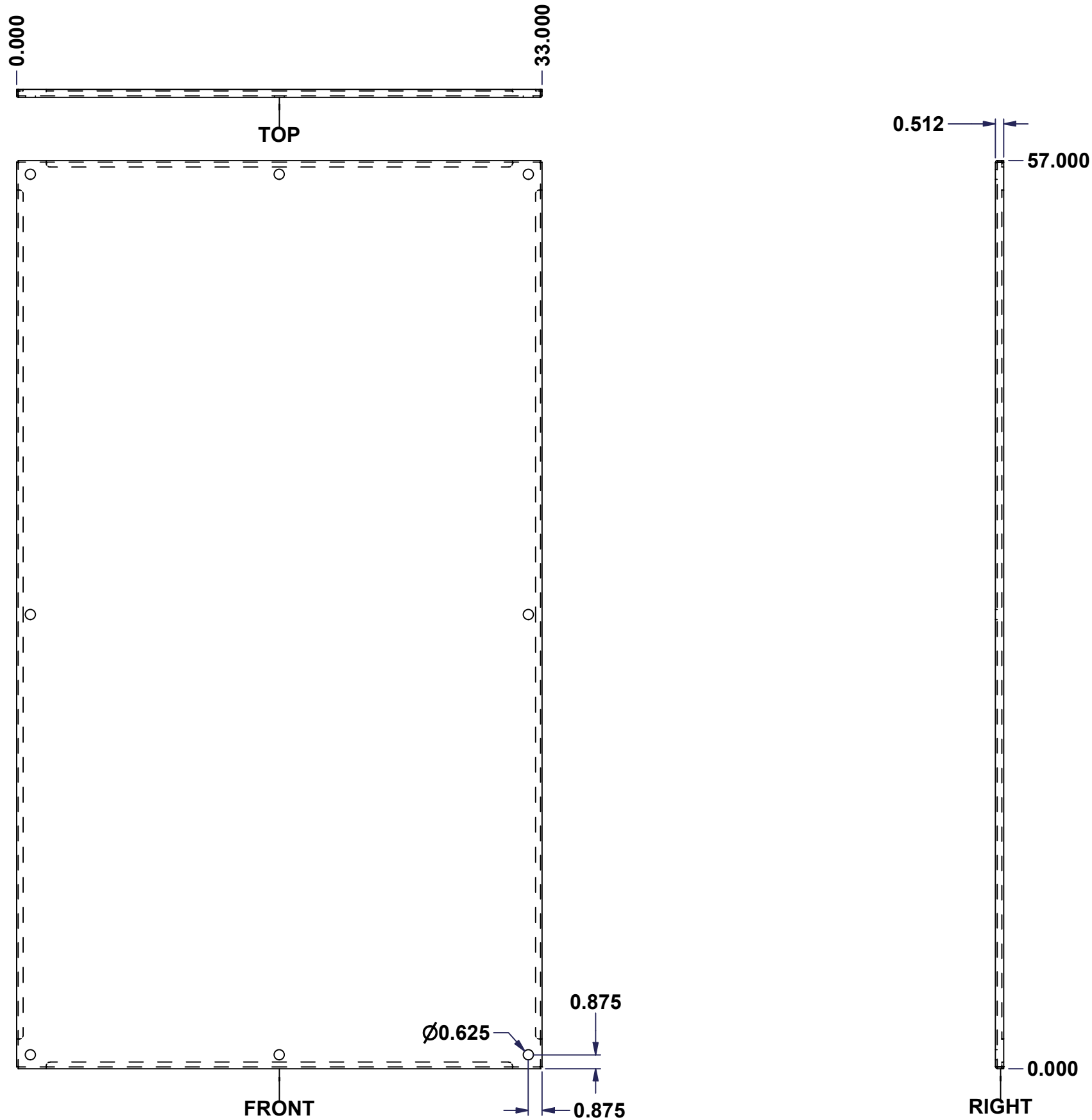

No.	Revisions	Date	By/Par

Isometric View

		Flatness Aplatissement Max 3.0mm	
Tél: (450) 979-4373 Fax: (450) 979-4626 www.exmweb.com		Projection 	
Customer Client		Date	
Drawn By Dessiné Par BoxCad: nickz		Date 01/03/2017	
Material Matière 12 Ga Galvanized (2.5mm)			
Color Couleur See Part List		Finish Fini See Part List	
Description 885SP 60" x 36" Inner Panel Part			Detail Rev.
Part Number Numéro Pièce 885SP6036G			Rev. 1 0

Qty	Part Number	Rev	Description	Material	Color	Finish
1	885SP6036G-P	0	885SP 60" x 36" Inner Panel Part	12 Ga Galvanized (2.5mm)	Unpainted	Galvanized

Parts List