

This drawing is confidential and must not be reproduced or used without the consent of EXM

Ce dessin est confidentiel et ne doit pas être reproduit ou utilisé sans le consentement de EXM

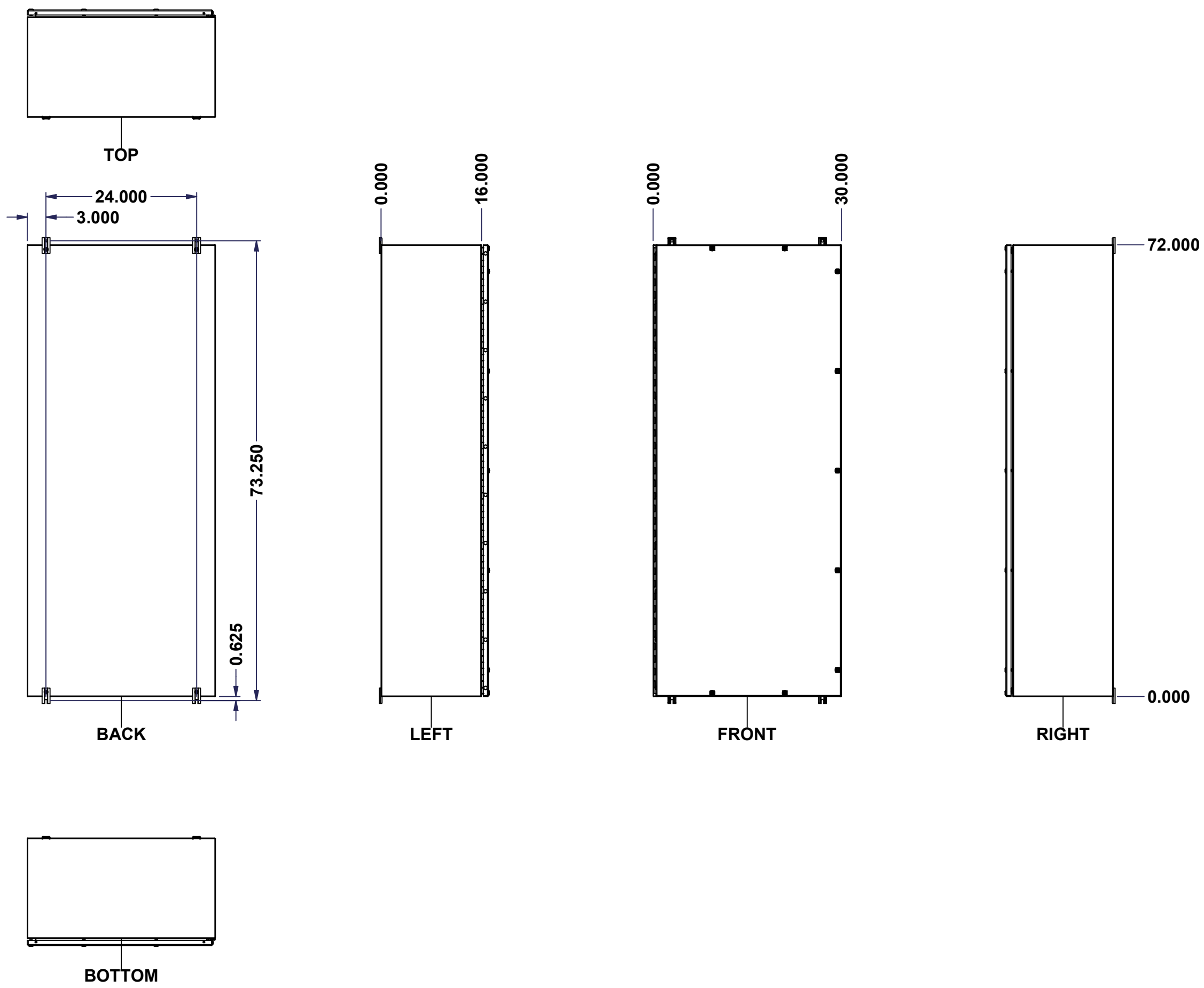

No.	Revisions	Date	By/Par

**Isometric View**

Tél: (450) 979-4373 Fax: (450) 979-4626 <a href="http://www.exmweb.com">www.exmweb.com</a>		Flatness Aplatissement Max 3.0mm Projection 
Customer Client	Date	
Drawn By / Dessiné Par: BoxCad: BoxCad	Date: 11-Feb-25	
Material / Matière: 14 Ga Cold Rolled A1008 CS Type B (1.7mm)		
Color / Couleur: Asa-61 Grey	Finish / Fini: Smooth	
Description: 5412ESEL 72" x 30" x 16" Assembly		Detail Rev.
Part Number / Numéro Pièce: 5412ESEL723016TH	Rev.:	1
SEE BILL OF MATERIAL ON LAST PAGE		0
		16

This drawing is confidential and must not be reproduced or used without the consent of EXM

Ce dessin est confidentiel et ne doit pas être reproduit ou utilisé sans le consentement de EXM

NOTE	
ITEM	DESCRIPTION
1	NEMA 4, 12 Enclosure (IP66)
2	C/W Standard ground studs on box and cover
3	C/W Standard door stiffener
4	C/W Standard inner panel (Included)
5	C/W Standard inner panel mounting studs
6	C/W 885 ESMF3_OPEN Sold separately (Installed)
7	C/W 885 ESMF3_CLOSE Sold separately (Installed)
8	C/W R5 Insulation (Installed aluminum visible)

No.	Revisions	Date	By/Par

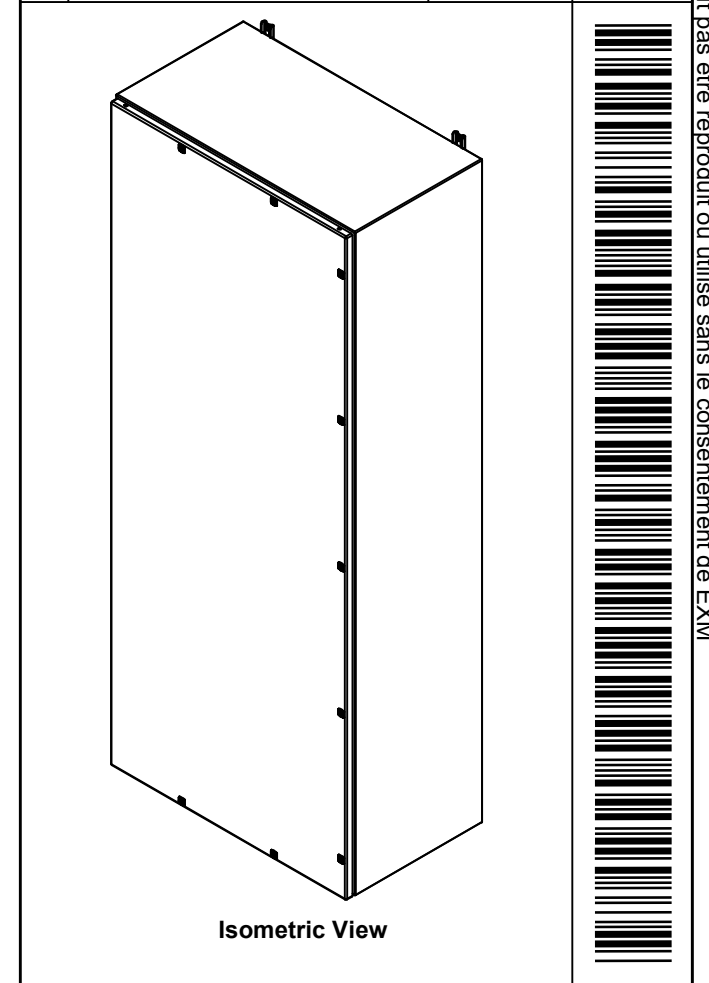

PACKING		
ITEM	QTY	DESCRIPTION
Cardboard sleeve	2	Top and Bottom
Cardboard strip	2	Between back of enclosure and inner panel
Plastic bag	1	To protect cover surface and inside gasket
Cardboard corner	4	To reinforced for the plastic strap tightening
Plastic strap - Black	2	To Squeeze 2 cardboard sleeve together
Packaging label	3	White label with PN
Plastic strap- Green	2	To secure the enclosure to the wood pallet
Wood Pallet	1	2" deeper and 3" larger than enclosure size

Qty	Part Number	Rev	Description
6	STK-Q-00600	2	M12 to M8 Adaptor
1	885SP7230G	0	885SP 72" x 30" Inner Panel Part
1	STK-K-01800	5	5412 ES Accessory Kit
10	RIVET_NUT_M6_FH_CE	0	Rivet Nut M6 (Low Profile Close End)
1	5412ESEL723016THC	0	5412ESEL 72" x 30" Cover
1	5412ESEL723016THB	0	5412ESEL 72" x 30" x 16" Body
10	STK-Q-04050-14	5	M6 x 14mm Hexagon Socket Head Machine Screw with Nyseal
Parts List			

<p>Tél: (450) 979-4373 Fax: (450) 979-4626 <a href="http://www.exmweb.com">www.exmweb.com</a></p>	Flatness Aplatissement	Max 3.0mm
	Projection	
Customer Client	Date	
Drawn By Dessiné Par	BoxCad: BoxCad	Date 11-Feb-25
Material Matière	14 Ga Cold Rolled A1008 CS Type B (1.7mm)	
Color Couleur	Asa-61 Grey	Finish Fini Smooth
Description	5412ESEL 72" x 30" x 16" Assembly	
Part Number Numéro Pièce	Rev. 0	2 / 16
<b>5412ESEL723016TH</b>		

This drawing is confidential and must not be reproduced or used without the consent of EXM

Ce dessin est confidentiel et ne doit pas être reproduit ou utilisé sans le consentement de EXM

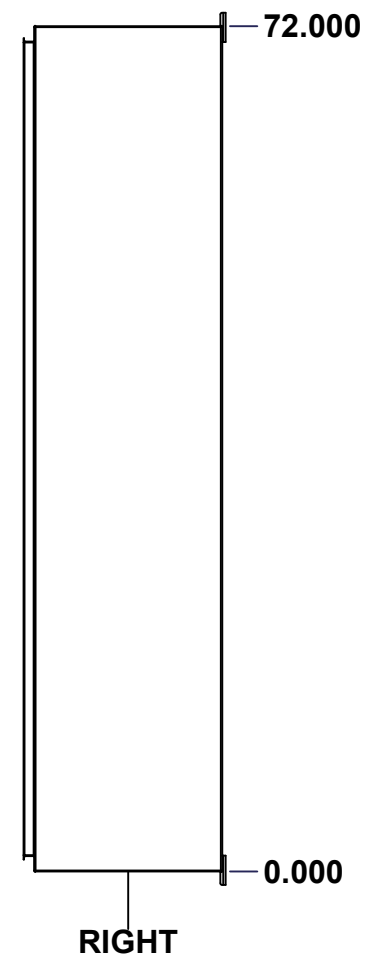
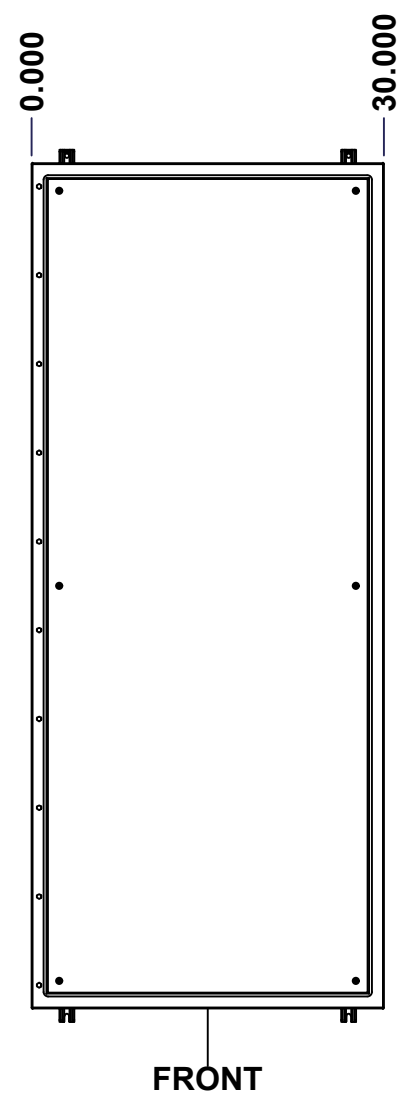
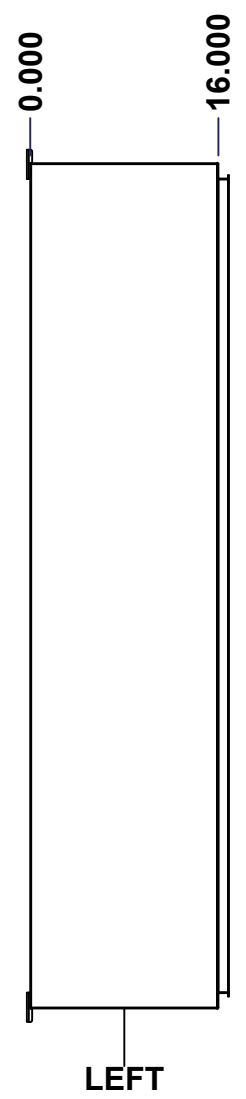
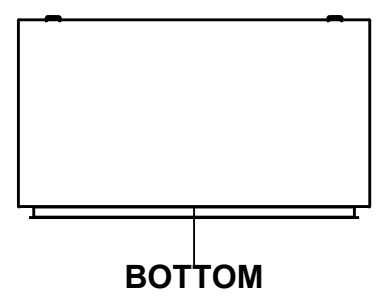
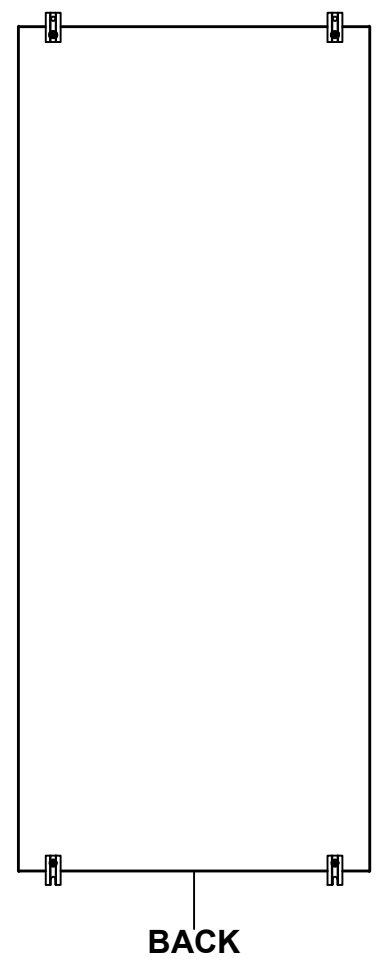
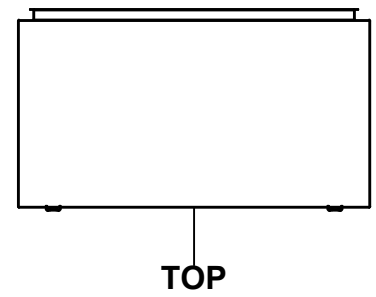

No.	Revisions	Date	By/Par

**Isometric View**

Tél: (450) 979-4373 Fax: (450) 979-4626 <a href="http://www.exmweb.com">www.exmweb.com</a>		Flatness Aplatissement	
		Max 3.0mm	
Customer Client		Date	
Drawn By Dessiné Par		Date	
Material Matière		Projection	
Color Couleur		Finish Fini	
Description		Detail Rev.	
Part Number Numéro Pièce		Rev.	

**SEE BILL OF MATERIAL ON LAST PAGE**

**5412ESEL723016THB**

This drawing is confidential and must not be reproduced or used without the consent of EXM

Ce dessin est confidentiel et ne doit pas être reproduit ou utilisé sans le consentement de EXM

<b>STANDARD FEATURES ARE NOT LISTED IN THIS HOLE TABLE</b>			
<b>HOLE TABLE - TOP VIEW (CUSTOM FEATURE ONLY)</b>			
CUT-OUT	XDIM	YDIM	DESCRIPTION
1	2.000	14.000	INSUL. STUD M6 x 18mm (Inside)
2	28.000	14.000	INSUL. STUD M6 x 18mm (Inside)

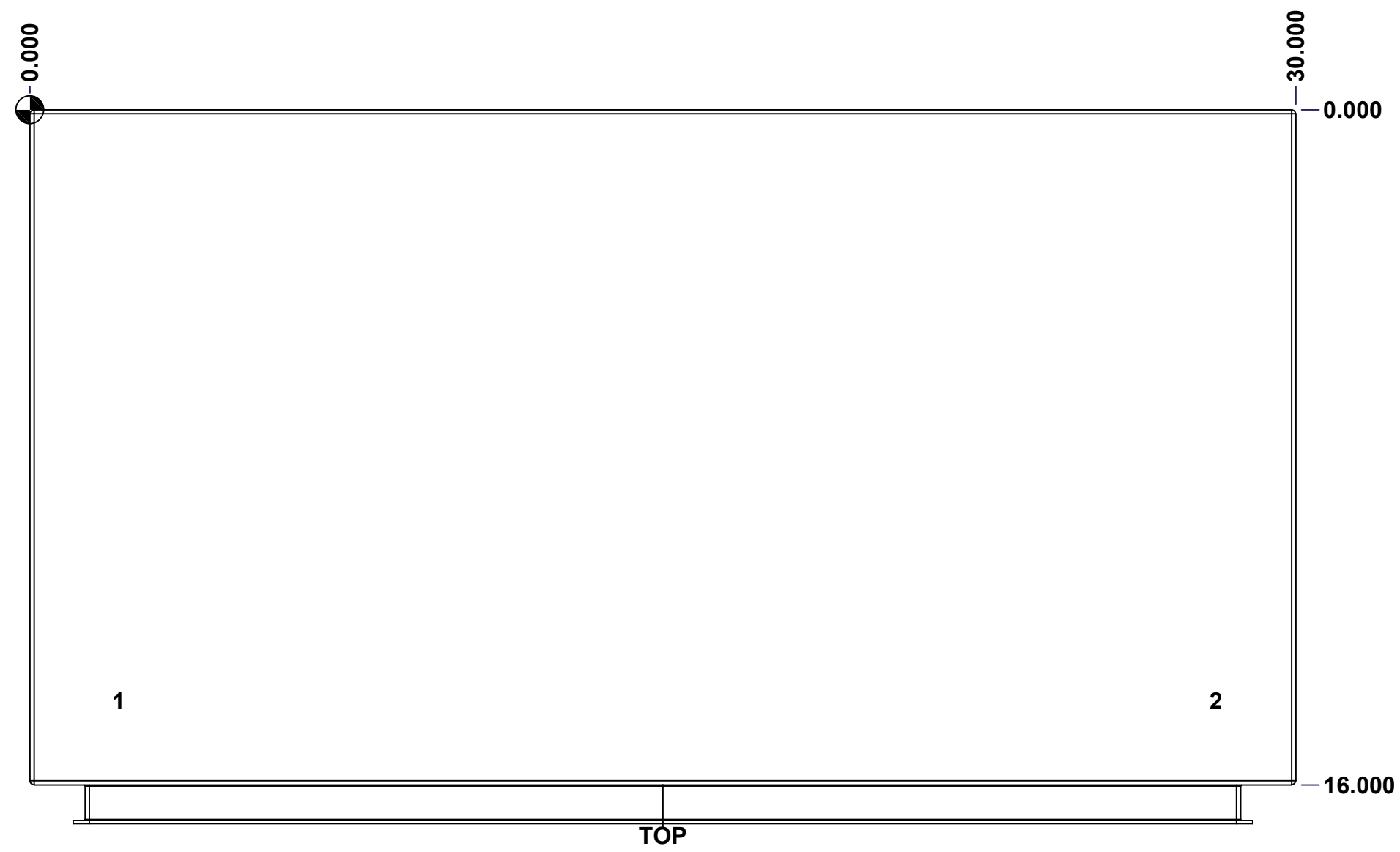

	Description	Status
	5412ESEL 72" x 30" x 16" Body	(NULL)
Part Number Numéro Pièce <b>5412ESEL723016THB</b>	Rev.	4
	<b>0</b>	16

This drawing is confidential and must not be reproduced or used without the consent of EXM

Ce dessin est confidentiel et ne doit pas être reproduit ou utilisé sans le consentement de EXM

STANDARD FEATURES ARE NOT LISTED IN THIS HOLE TABLE			
HOLE TABLE - BOTTOM VIEW (CUSTOM FEATURE ONLY)			
CUT-OUT	XDIM	YDIM	DESCRIPTION
1	2.000	14.000	INSUL. STUD M6 x 18mm (Inside)
2	28.000	14.000	INSUL. STUD M6 x 18mm (Inside)



	Description	Status
	5412ESEL 72" x 30" x 16" Body	(NULL)
	Part Number Numéro Pièce	Rev.
	<b>5412ESEL723016THB</b>	<b>0</b> / 5
		16

This drawing is confidential and must not be reproduced or used without the consent of EXM

Ce dessin est confidentiel et ne doit pas être reproduit ou utilisé sans le consentement de EXM

**STANDARD FEATURES ARE NOT LISTED IN THIS HOLE TABLE**

**HOLE TABLE - BACK VIEW (CUSTOM FEATURE ONLY)**

CUT-OUT	XDIM	YDIM	DESCRIPTION
1	2.375	2.375	IP STUD M8 x 35mm (Inside)
2	2.375	69.625	IP STUD M8 x 35mm (Inside)
3	27.625	69.625	IP STUD M8 x 35mm (Inside)
4	27.625	2.375	IP STUD M8 x 35mm (Inside)
5	2.375	36.000	IP STUD M8 x 35mm (Inside)
6	27.625	36.000	IP STUD M8 x 35mm (Inside)
-----			
7	27.000	0.000	FOOT 885 ESMF3_OPEN
8	3.000	0.000	FOOT 885 ESMF3_OPEN
9	27.000	72.000	FOOT 885 ESMF3_CLOSE
10	3.000	72.000	FOOT 885 ESMF3_CLOSE

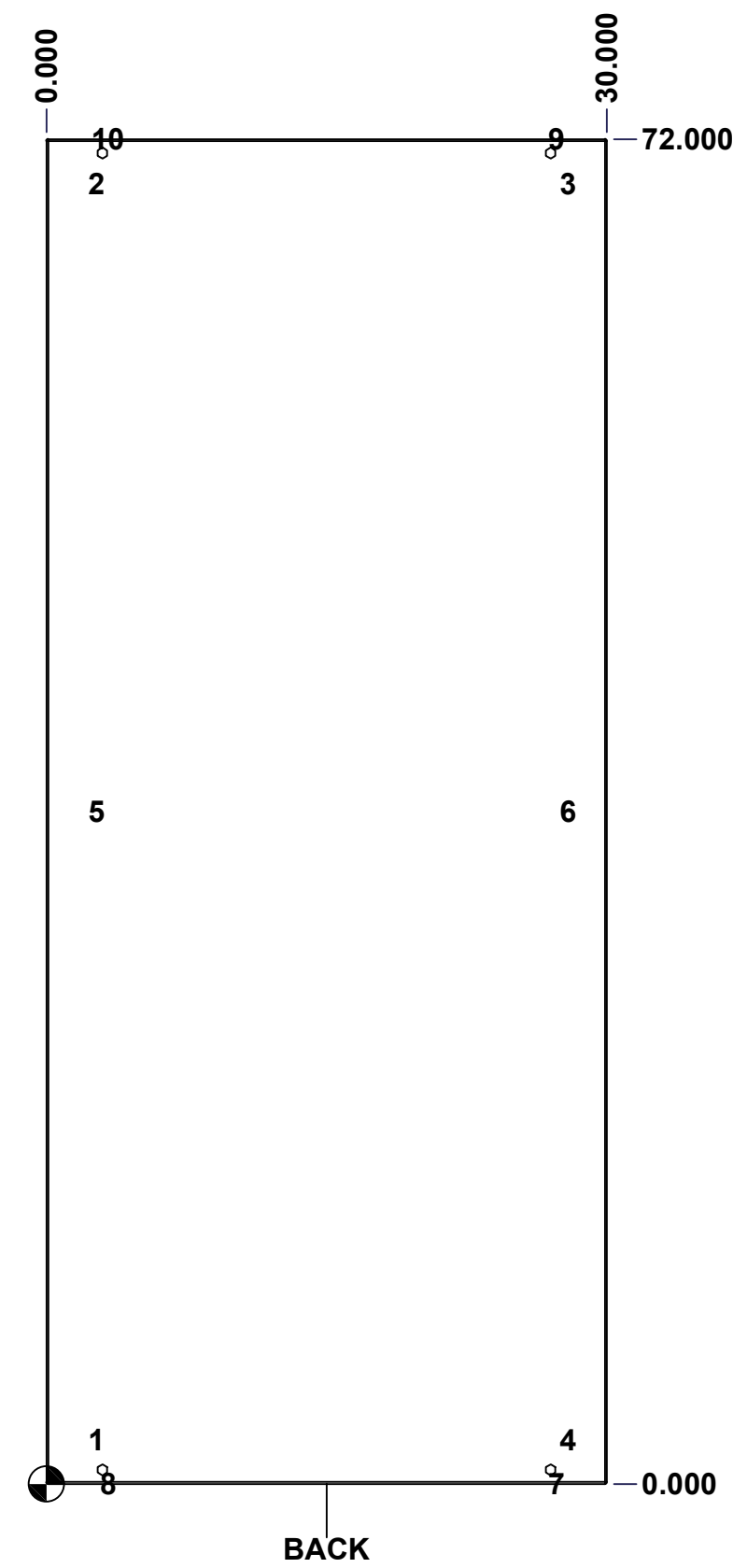

	Description	Status
	5412ESEL 72" x 30" x 16" Body	(NULL)
	Part Number Numéro Pièce	Rev.
	<b>5412ESEL723016THB</b>	<b>0</b> / 6
		16

This drawing is confidential and must not be reproduced or used without the consent of EXM

Ce dessin est confidentiel et ne doit pas être reproduit ou utilisé sans le consentement de EXM

No.	Revisions	Date	By/Par

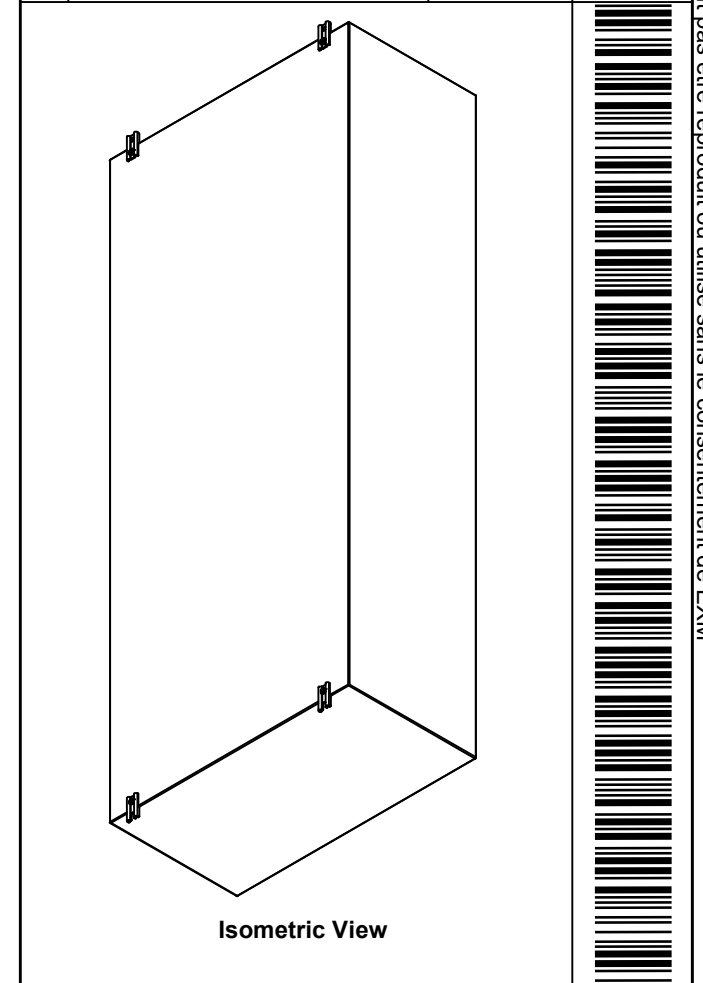

1	885 ESMF3	0	885 ESMF3 Mounting Foot Kit
4	RIVET_NUT_M10_FH_CE	0	Rivet Nut M10 (Low Profile Close End)
1	STK-K-70554	3	5412 ESTH Accessory Kit
1	5412ESEL723016THI-RS	0	5412ESEL 72" x 30" Right Insulation
1	5412ESEL723016THI-LS	0	5412ESEL 72" x 30" Left Insulation
1	5412ESEL723016THI-BT	0	5412ESEL 72" x 30"Bottom Insulation
1	5412ESEL723016THI-TP	0	5412ESEL 72" x 30"Top Insulation
1	5412ESEL723016THI-B	0	5412ESEL 72" x 30" Back Insulation
4	STK-Q-16055	1	M6 x 18mm Stud (No Paint Cap Required)
1	STK-P-02400S	0	Powder Paint (Asa-61 Grey / Smooth)
6	STK-Q-16005	0	Stud M8 x 35mm Steel
1	5412ESEL723016THB-P	0	5412ESEL 72" x 30" x 16" Body Part
Qty	Part Number	Rev	Description
Parts List			

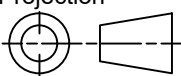
 Tél: (450) 979-4373 Fax: (450) 979-4626 <a href="http://www.exmweb.com">www.exmweb.com</a>		Flatness Aplatissement Max 3.0mm
Projection 		Customer Client
Drawn By Dessiné Par BoxCad: BoxCad		Date 11-Feb-25
Material Matière 14 Ga Cold Rolled A1008 CS Type B (1.7mm)		
Color Couleur Asa-61 Grey	Finish Fini Smooth	
Description 5412ESEL 72" x 30" x 16" Body		Detail Rev.
Part Number Numéro Pièce <b>5412ESEL723016THB</b>		Rev. 7 <b>0</b>

This drawing is confidential and must not be reproduced or used without the consent of EXM

Ce dessin est confidentiel et ne doit pas être reproduit ou utilisé sans le consentement de EXM

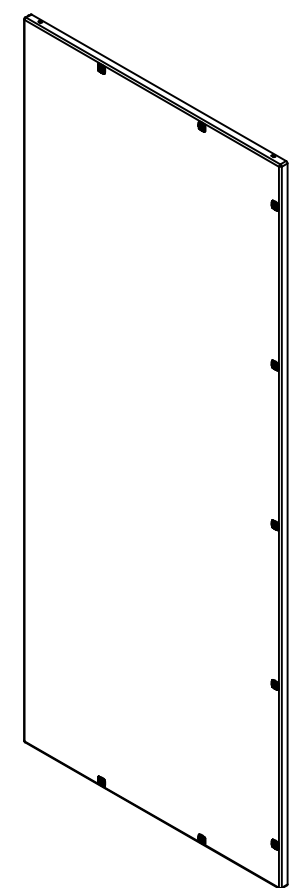
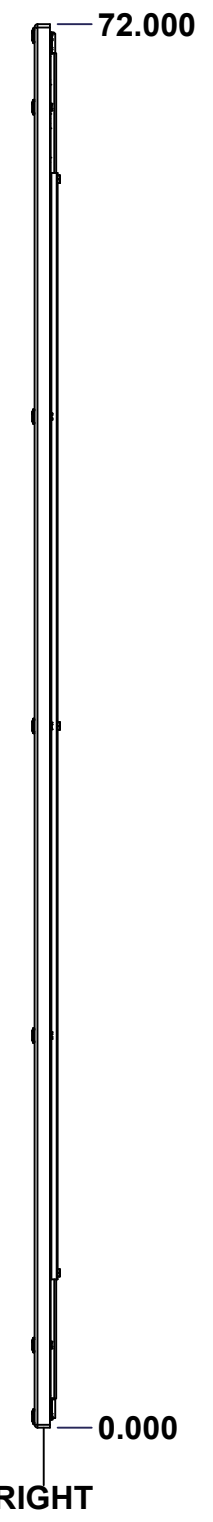
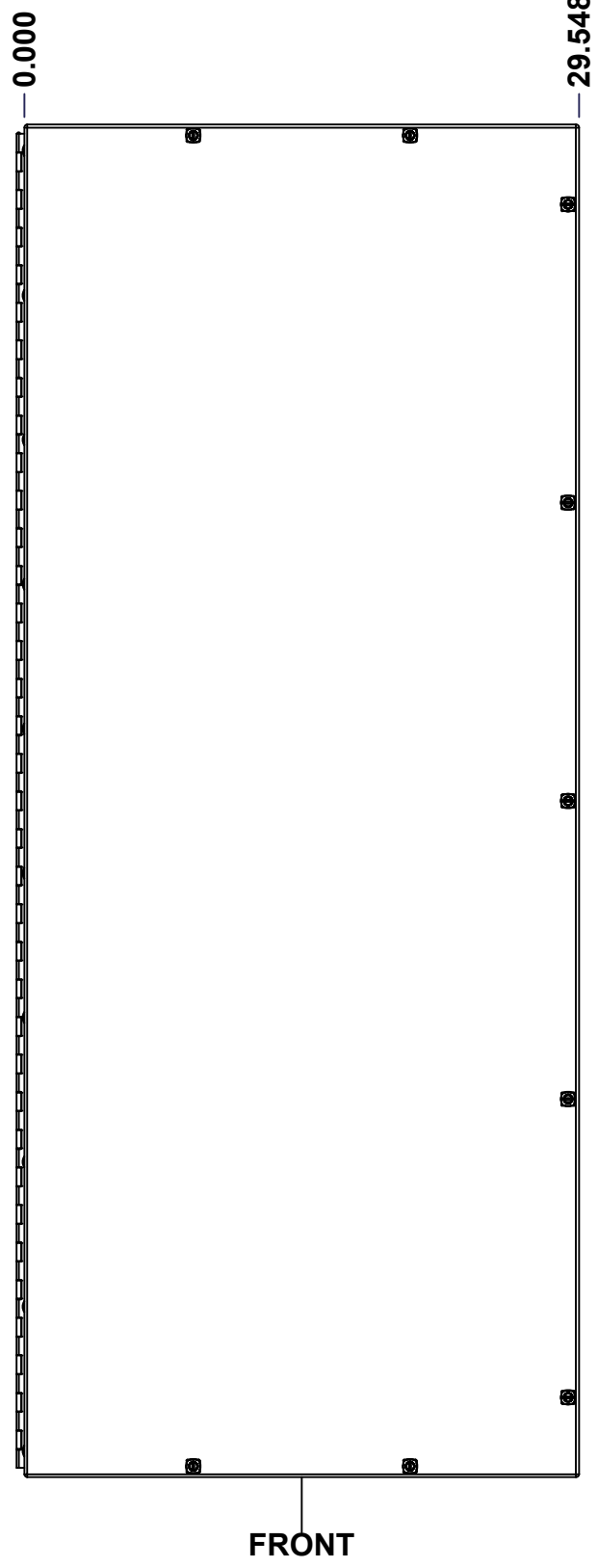
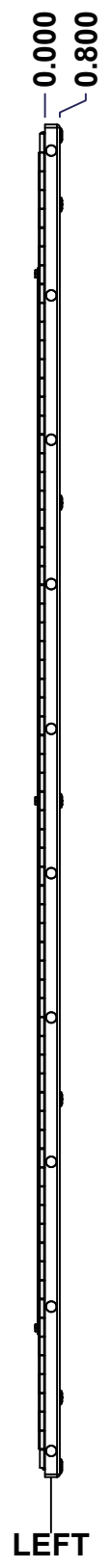
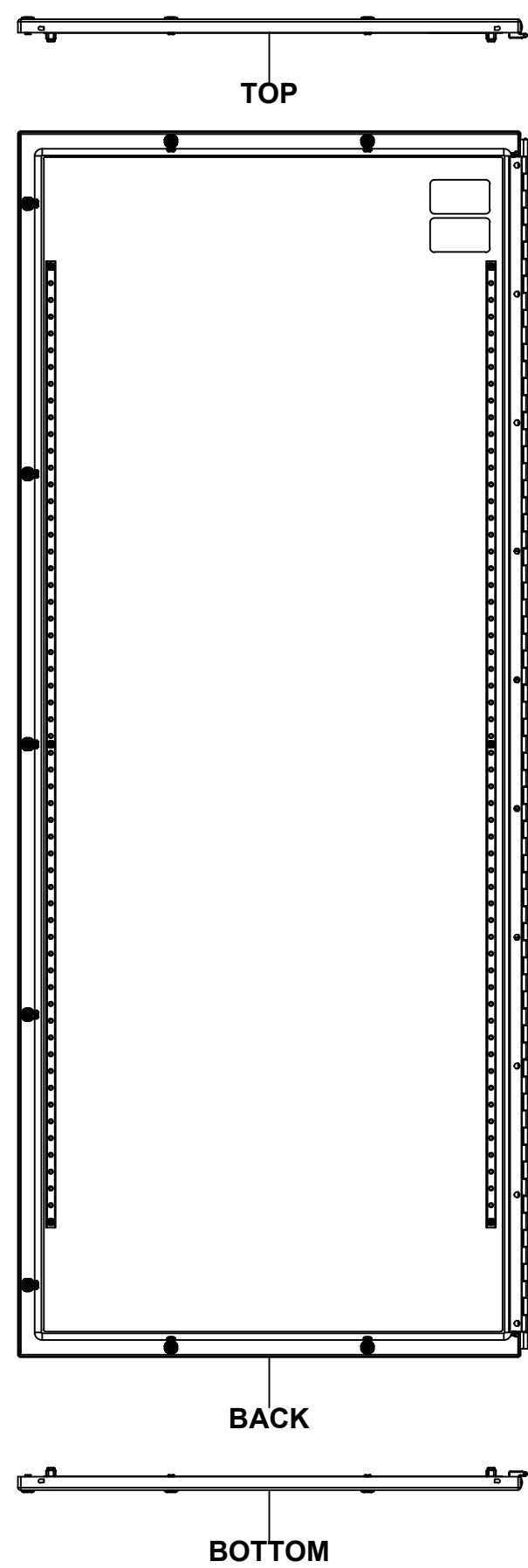

Isometric View

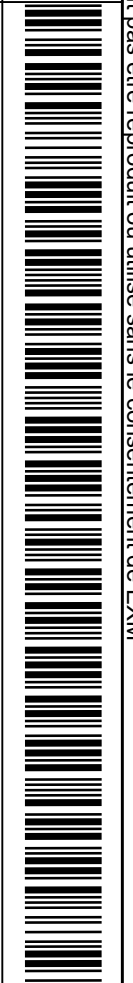

No.	Revisions	Date	By/Par

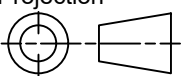
 Tél: (450) 979-4373 Fax: (450) 979-4626 <a href="http://www.exmweb.com">www.exmweb.com</a>		Flatness Aplatissement Max 3.0mm Projection 
Customer Client	Date	
Drawn By Dessiné Par	BoxCad: BoxCad	Date 11-Feb-25
Material Matière	14 Ga Cold Rolled A1008 CS Type B (1.7mm)	
Color Couleur	Asa-61 Grey	Finish Fini Smooth
Description 5412ESEL 72" x 30" Cover		Detail Rev.
Part Number Numéro Pièce	Rev. 0	8 / 16

SEE BILL OF MATERIAL ON LAST PAGE

**5412ESEL723016THC**

This drawing is confidential and must not be reproduced or used without the consent of EXM

Ce dessin est confidentiel et ne doit pas être reproduit ou utilisé sans le consentement de EXM

**STANDARD FEATURES ARE NOT LISTED IN THIS HOLE TABLE**

**HOLE TABLE - FRONT VIEW (CUSTOM FEATURE ONLY)**

CUT-OUT	XDIM	YDIM	DESCRIPTION
1	1.729	7.949	STUD M6 x 18mm (Inside)
2	1.729	64.051	STUD M6 x 18mm (Inside)
3	1.729	36.000	STUD M6 x 18mm (Inside)
4	27.609	7.949	STUD M6 x 18mm (Inside)
5	27.609	64.051	STUD M6 x 18mm (Inside)
6	27.609	36.000	STUD M6 x 18mm (Inside)
-----			
7	28.968	67.750	LOCK 880 SCQ5-SL @ 180.0°
8	28.968	20.125	LOCK 880 SCQ5-SL @ 180.0°
9	28.968	36.000	LOCK 880 SCQ5-SL @ 180.0°
10	9.000	71.420	LOCK 880 SCQ5-SL @ 270.0°
11	20.548	71.420	LOCK 880 SCQ5-SL @ 270.0°
12	9.000	0.580	LOCK 880 SCQ5-SL @ 90.0°
13	20.548	0.580	LOCK 880 SCQ5-SL @ 90.0°
14	28.968	51.875	LOCK 880 SCQ5-SL @ 180.0°
15	28.968	4.250	LOCK 880 SCQ5-SL @ 180.0°

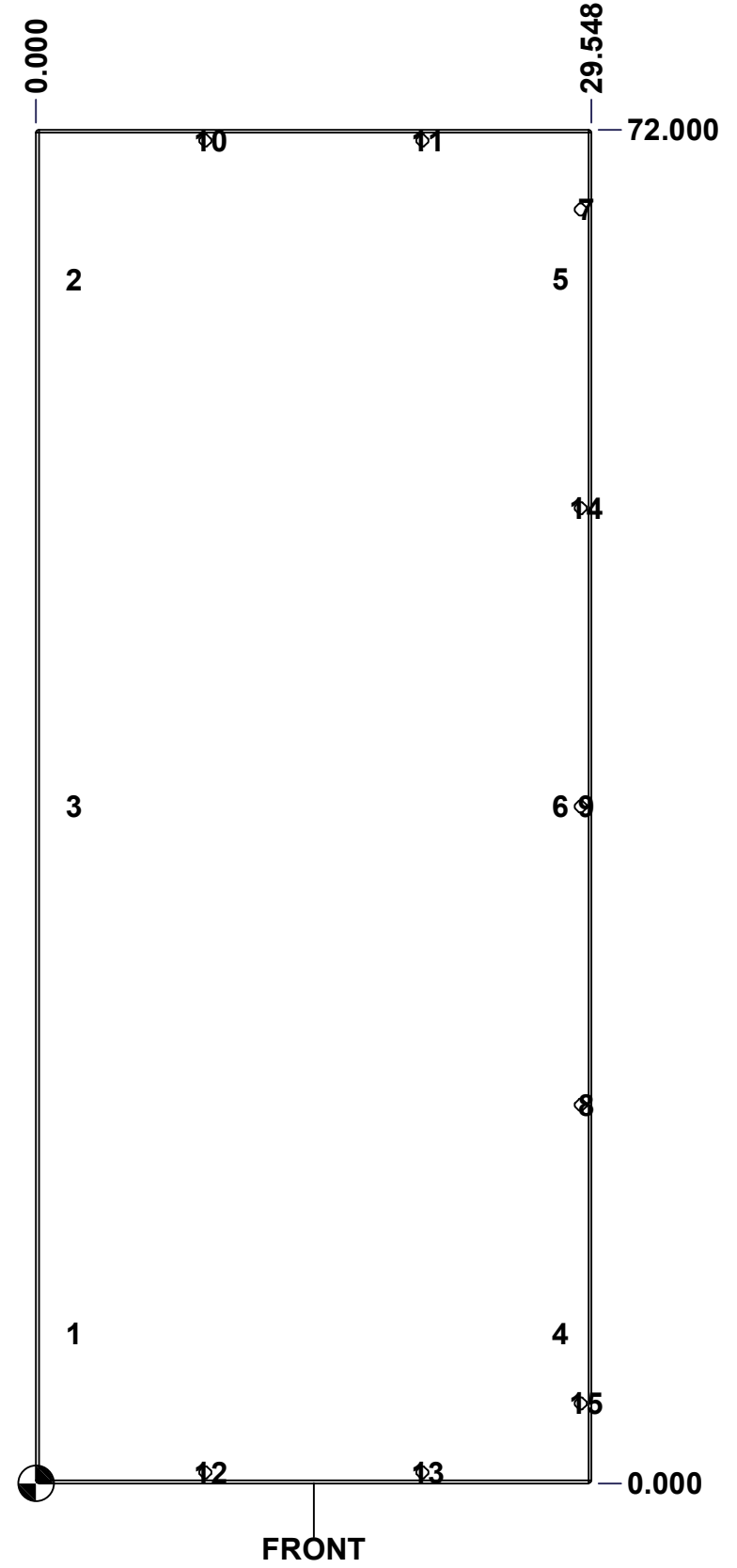

FRONT

	Description	Status
	5412ESEL 72" x 30" Cover	(NULL)
Part Number Numéro Pièce <b>5412ESEL723016THC</b>	Rev.	9
	<b>0</b>	16

This drawing is confidential and must not be reproduced or used without the consent of EXM

Ce dessin est confidentiel et ne doit pas être reproduit ou utilisé sans le consentement de EXM

No.	Revisions	Date	By/Par

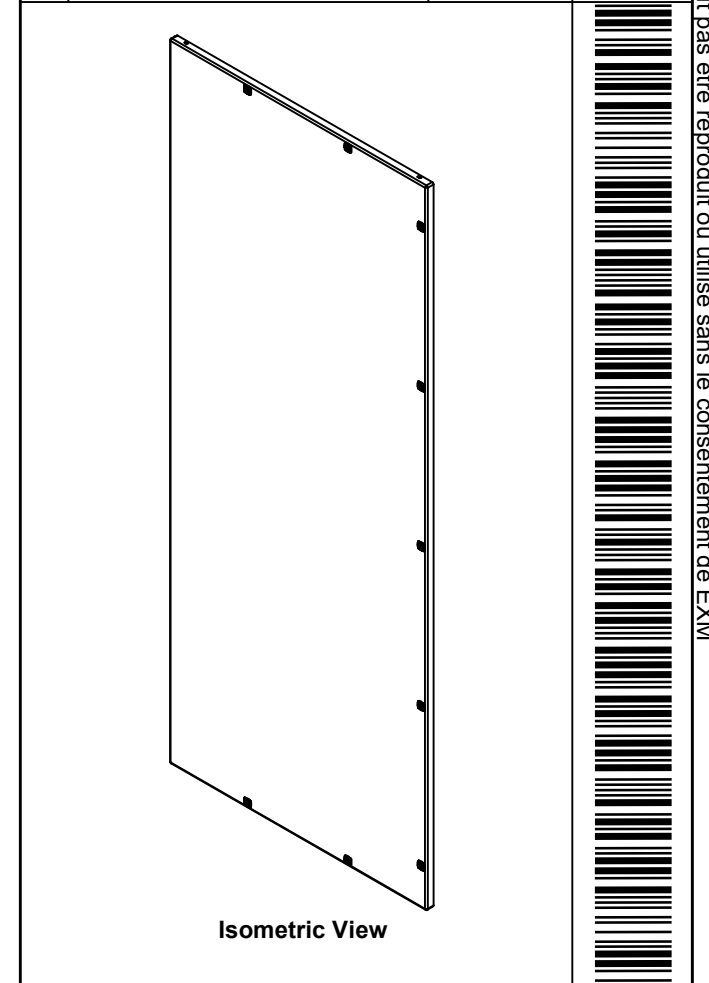

2	STK-S-00100	0	3.5" x 2" Silver Milar Flexcon Sticker
6	STK-Q-07250	2	M6 x 16mm Collar Nut
2	STK-Q-46020-60	5	5412 ES Vertical Door Stiffener 60"
1	5412ESEL723016THI-C	0	5412ESEL 72" x 30" Cover Insulation
1	STK-P-02400S	0	Powder Paint (Asa-61 Grey / Smooth)
6	STK-Q-16055	1	M6 x 18mm Stud (No Paint Cap Required)
10	STK-Q-00260	1	M6 x 13mm Carriage Bolt
1	5412ESEL723016THHP-P	0	Piano Hinge Pin (Length= 71.181")
1	5412ESEL723016THH1-P	0	5412ESEL 72" x 30" Piano Hinge Part
1	5412ESEL723016THH2-P	0	5412ESEL 72" x 30" Piano Hinge Part
1	5412ESEL723016THG	0	5412ESEL 72" x 30" Cover Gasket Part
1	5412ESEL723016THC-P	0	5412ESEL 72" x 30" Cover Part
9	880 SCQ5-SL		5412 ESEL 1/4 Turn Lock
10	STK-Q-07225	0	M6 Stainless Steel Nylon Insert Lock Nut

QTY	Part Number	Rev	Description
Parts List			

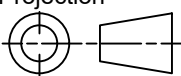
 Tél: (450) 979-4373 Fax: (450) 979-4626 <a href="http://www.exmweb.com">www.exmweb.com</a>		Flatness Aplatissement Max 3.0mm Projection 
Customer Client	Date	
Drawn By Dessiné Par	BoxCad: BoxCad	Date 11-Feb-25
Material Matière	14 Ga Cold Rolled A1008 CS Type B (1.7mm)	
Color Couleur	Asa-61 Grey	Finish Fini Smooth
Description		Detail Rev.
5412ESEL 72" x 30" Cover		
Part Number Numéro Pièce	Rev. 0	10 / 16
<b>5412ESEL723016THC</b>		

This drawing is confidential and must not be reproduced or used without the consent of EXM

Ce dessin est confidentiel et ne doit pas être reproduit ou utilisé sans le consentement de EXM

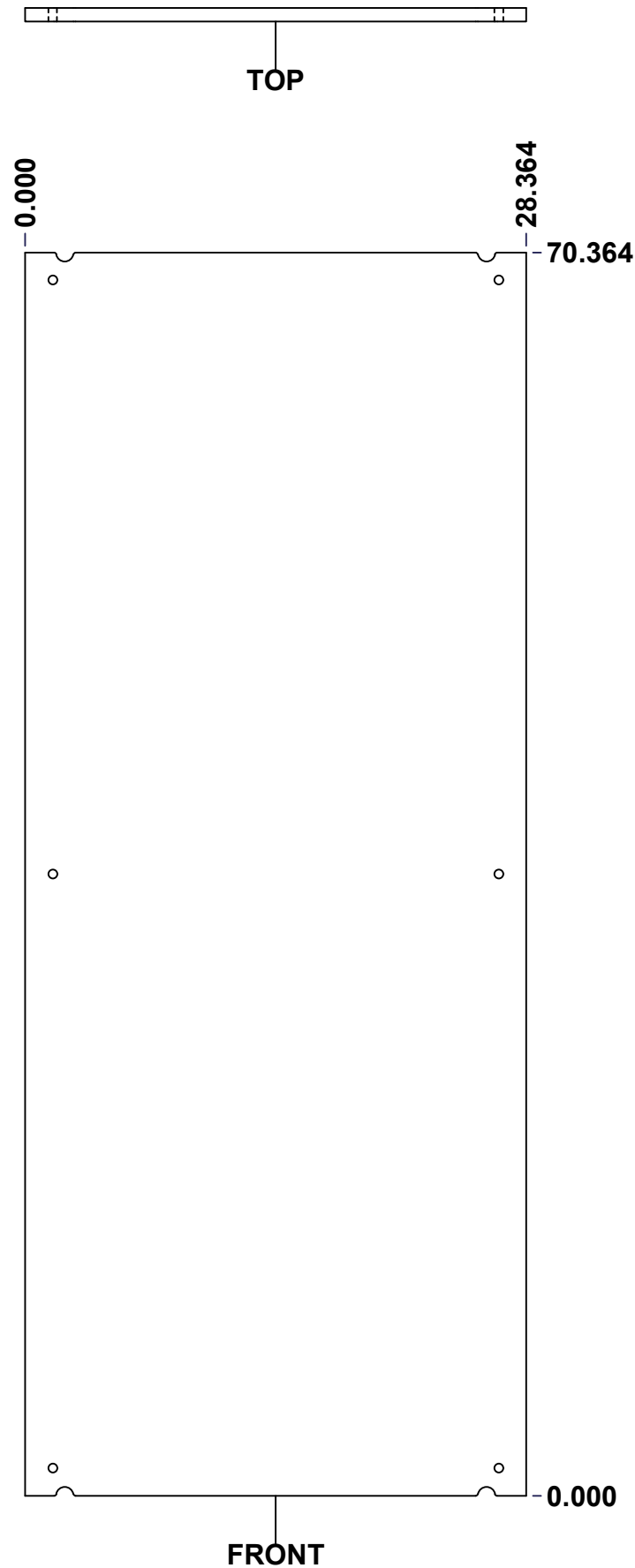

No.	Revisions	Date	By/Par

**Isometric View**

<p>Tél: (450) 979-4373                  Fax: (450) 979-4626  <a href="http://www.exmweb.com">www.exmweb.com</a></p>		Flatness Aplatissement	
		Max 3.0mm	
Customer Client		Date	
Drawn By Dessiné Par		Date	
Material Matière		Polyisocyanurate	
Color Couleur		Aluminum	Finish Fini
Description		Detail Rev.	
5412ESEL 72" x 30" Back Insulation			
Part Number Numéro Pièce		Rev.	
5412ESEL723016TH-B		0	11 16

**SEE BILL OF MATERIAL ON LAST PAGE**

This drawing is confidential and must not be reproduced or used without the consent of EXM

Ce dessin est confidentiel et ne doit pas être reproduit ou utilisé sans le consentement de EXM

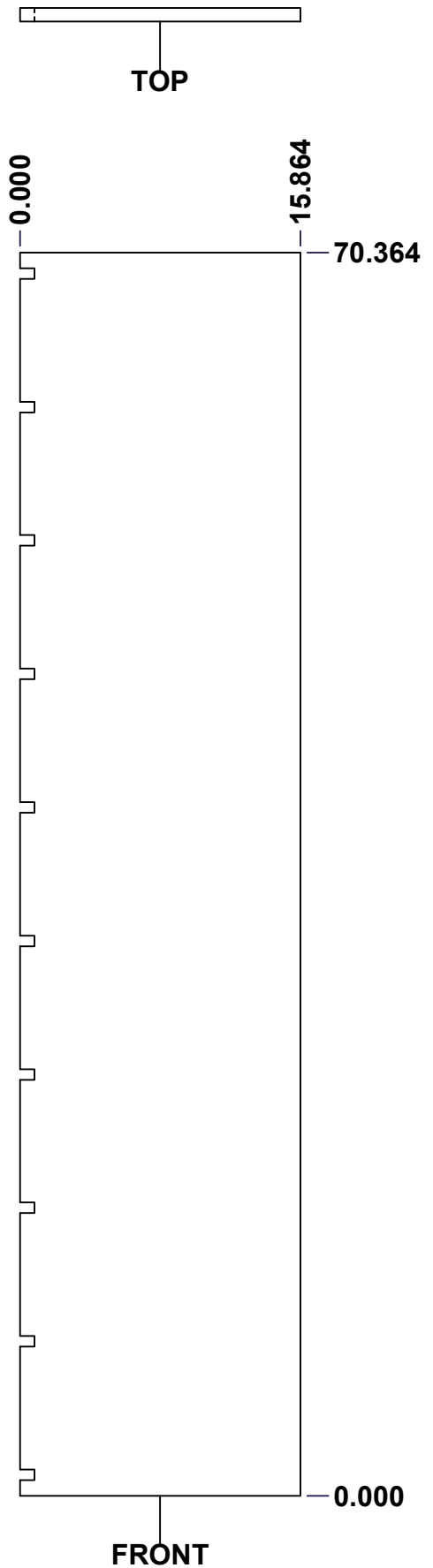

No.	Revisions	Date	By/Par

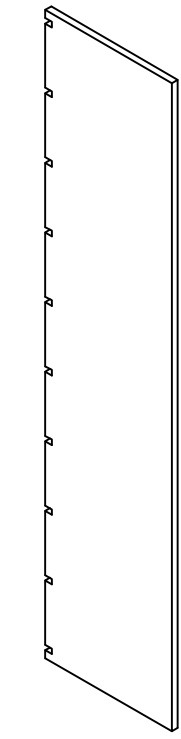

Isometric View

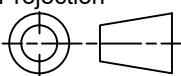

 Tél: (450) 979-4373 Fax: (450) 979-4626 <a href="http://www.exmweb.com">www.exmweb.com</a>	Flatness Aplatissement Max 3.0mm
	Projection 
Customer Client	Date
Drawn By Dessiné Par BoxCad: Patrick Deschenes	Date 23-Jan-07
Material Matière Polyisocyanurate	
Color Couleur Aluminum	Finish Fini N/A
Description 5412ESEL 72" x 30" Left Insulation	Detail Rev.
Part Number Numéro Pièce <b>5412ESEL723016THI-LS</b>	Rev. 0
	12 / 16

SEE BILL OF MATERIAL ON LAST PAGE

This drawing is confidential and must not be reproduced or used without the consent of EXM

Ce dessin est confidentiel et ne doit pas être reproduit ou utilisé sans le consentement de EXM

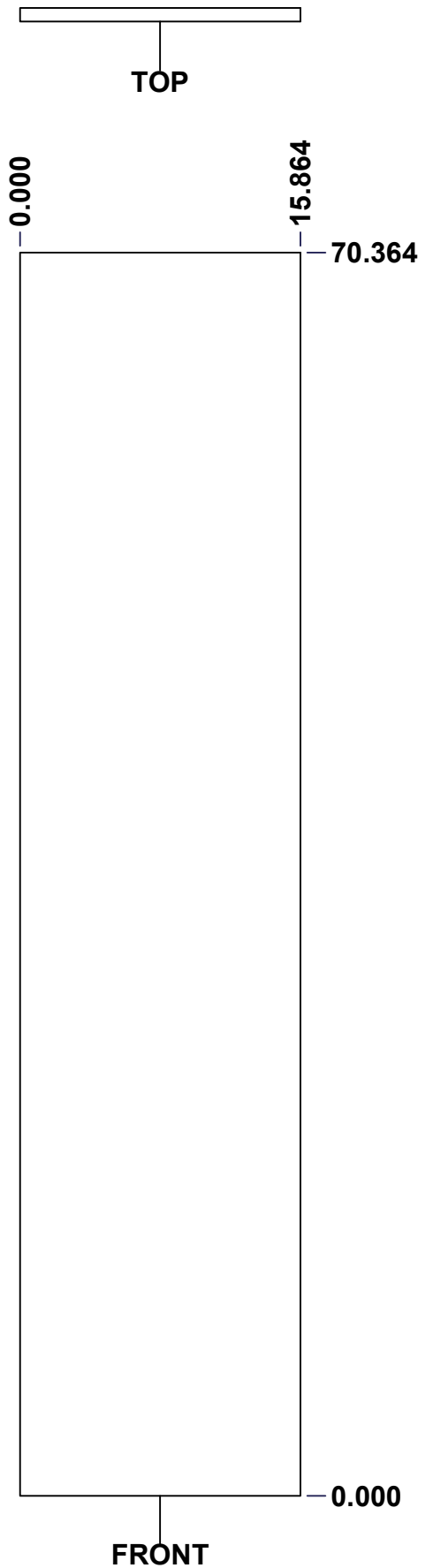

0.000  
0.750

No.	Revisions	Date	By/Par

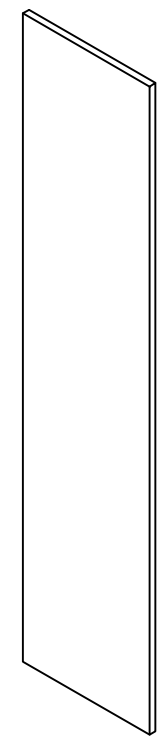

Isometric View



Tél: (450) 979-4373  
Fax: (450) 979-4626  
[www.exmweb.com](http://www.exmweb.com)

Flatness  
Aplatissement  
Max 3.0mm  
Projection

Customer Client	Date
Drawn By / Dessiné Par: BoxCad: Patrick Deschenes	Date: 23-Jan-07
Material / Matière: Polyisocyanurate	
Color / Couleur: Aluminum	Finish / Fini: N/A

Description: 5412ESEL 72" x 30" Right Insulation  
Detail Rev.

Part Number / Numéro Pièce: 5412ESEL723016THI-RS	Rev. 0	13
SEE BILL OF MATERIAL ON LAST PAGE		16

This drawing is confidential and must not be reproduced or used without the consent of EXM

Ce dessin est confidentiel et ne doit pas être reproduit ou utilisé sans le consentement de EXM

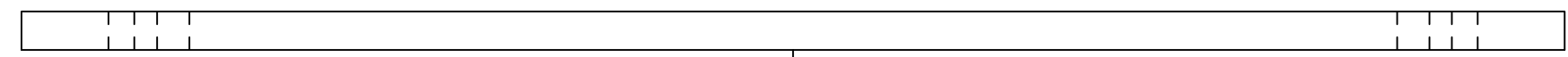

TOP



FRONT

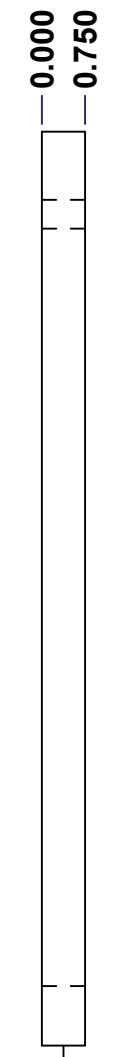

RIGHT

No.	Revisions	Date	By/Par

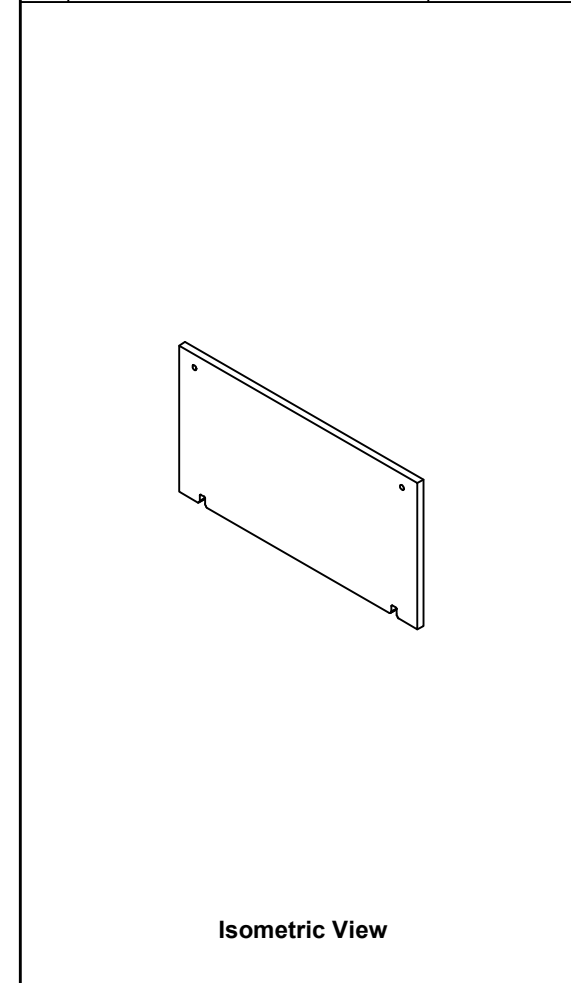

Isometric View

 Tél: (450) 979-4373  
 Fax: (450) 979-4626  
[www.exmweb.com](http://www.exmweb.com)

Flatness / Aplatissement: Max 3.0mm  
 Projection: 

Customer Client	Date
Drawn By / Dessiné Par: BoxCad: BoxCad	Date: 4/3/2024

Material / Matière: Polyisocyanurate

Color / Couleur: Aluminum	Finish / Fini: Smooth
---------------------------	-----------------------

Description: 5412ESEL 72" x 30"Top Insulation	Detail Rev.
---	-------------

Part Number / Numéro Pièce: 5412ESEL723016THI-TP	Rev. 0	14 / 16
--	--------	---------

SEE BILL OF MATERIAL ON LAST PAGE

This drawing is confidential and must not be reproduced or used without the consent of EXM

Ce dessin est confidentiel et ne doit pas être reproduit ou utilisé sans le consentement de EXM

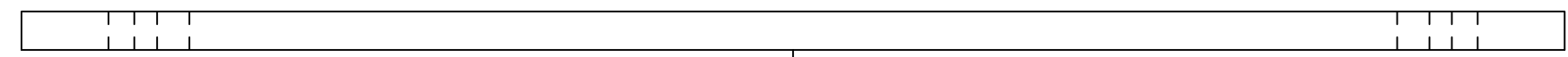

TOP



FRONT

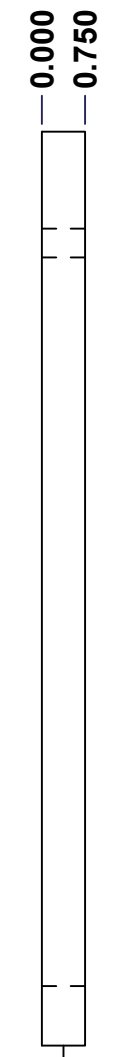

RIGHT

No.	Revisions	Date	By/Par

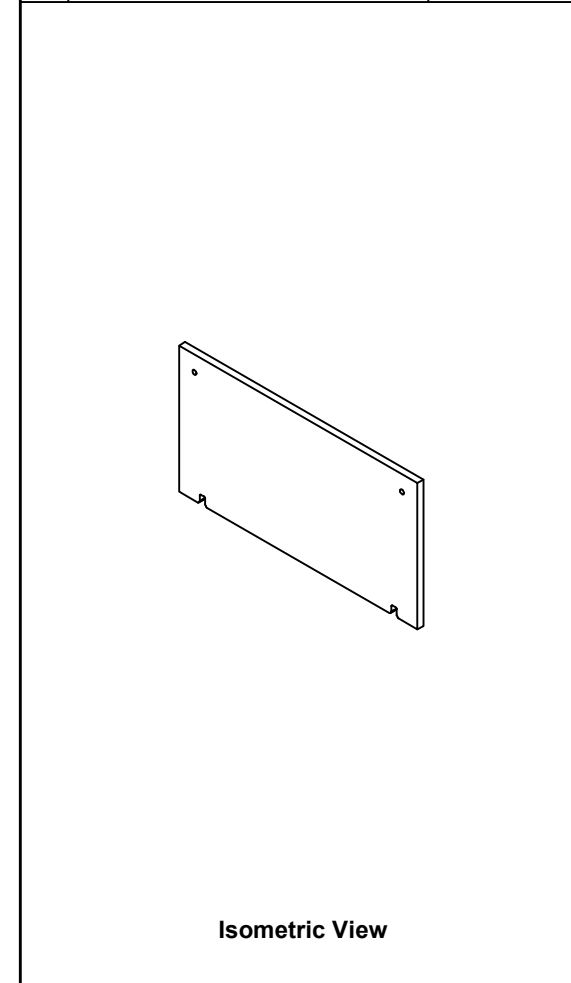
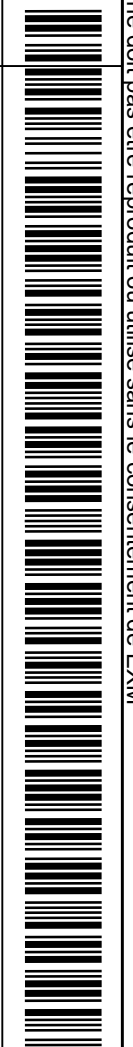

Isometric View

 Tél: (450) 979-4373  
 Fax: (450) 979-4626  
[www.exmweb.com](http://www.exmweb.com)

Flatness / Aplatissement: Max 3.0mm  
 Projection: 

Customer / Client	Date
Drawn By / Dessiné Par: BoxCad: BoxCad	Date: 4/3/2024

Material / Matière: Polyisocyanurate

Color / Couleur: Aluminum	Finish / Fini: Smooth
---------------------------	-----------------------

Description: 5412ESEL 72" x 30" Bottom Insulation	Detail Rev.
---	-------------

Part Number / Numéro Pièce: 5412ESEL723016THI-BT	Rev. 0	15	16
--	--------	----	----

SEE BILL OF MATERIAL ON LAST PAGE

This drawing is confidential and must not be reproduced or used without the consent of EXM

Ce dessin est confidentiel et ne doit pas être reproduit ou utilisé sans le consentement de EXM

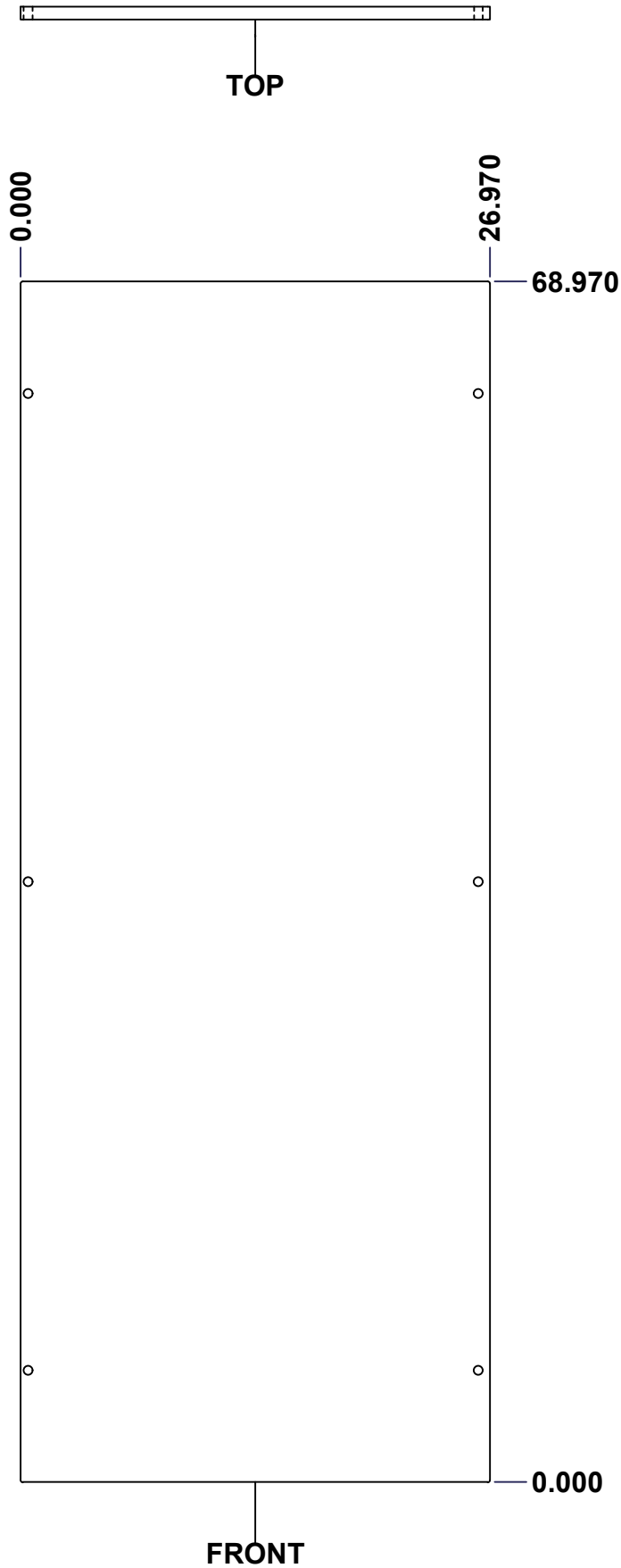

0.000  
0.750

68.970

0.000

No.	Revisions	Date	By/Par

**Isometric View**

<p>Tél: (450) 979-4373 Fax: (450) 979-4626 <a href="http://www.exmweb.com">www.exmweb.com</a></p>		Flatness Aplatissement	
		Max 3.0mm	
Customer Client		Date	
Drawn By Dessiné Par		Date 23-Jan-07	
Material Matière		Polyisocyanurate	
Color Couleur	Aluminum	Finish Fini	N/A
Description			Detail Rev.
5412ESEL 72" x 30" Cover Insulation			
Part Number Numéro Pièce		Rev.	16
5412ESEL723016TH-C		0	16

**SEE BILL OF MATERIAL ON LAST PAGE**

This drawing is confidential and must not be reproduced or used without the consent of EXM

Ce dessin est confidentiel et ne doit pas être reproduit ou utilisé sans le consentement de EXM

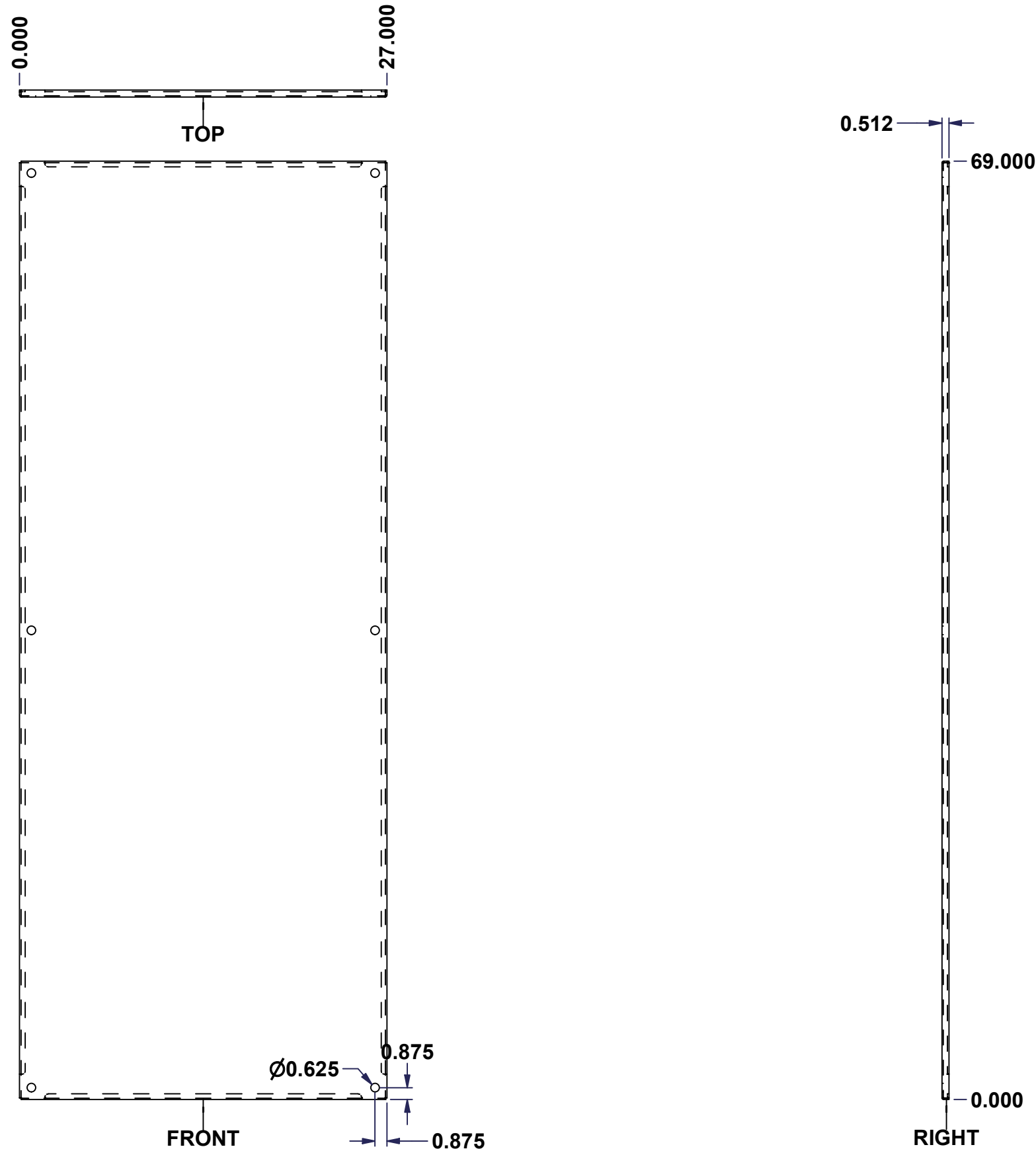

No.	Revisions	Date	By/Par

**Isometric View**

		Flatness Aplatissement Max 3.0mm	
Tél: (450) 979-4373 Fax: (450) 979-4626 <a href="http://www.exmweb.com">www.exmweb.com</a>		Projection 	
Customer Client		Date	
Drawn By / Dessiné Par: BoxCad: nickz		Date: 01/03/2017	
Material / Matière: 12 Ga Galvanized (2.5mm)			
Color / Couleur: See Part List		Finish / Fini: See Part List	
Description: 885SP 72" x 30" Inner Panel Part			Detail Rev.
Part Number / Numéro Pièce: <b>885SP7230G</b>			Rev. 1

Qty	Part Number	Rev	Description	Material	Color	Finish
1	885SP7230G-P	0	885SP 72" x 30" Inner Panel Part	12 Ga Galvanized (2.5mm)	Unpainted	Galvanized

Parts List