

This drawing is confidential and must not be reproduced or used without the consent of EXM

Ce dessin est confidentiel et ne doit pas être reproduit ou utilisé sans le consentement de EXM

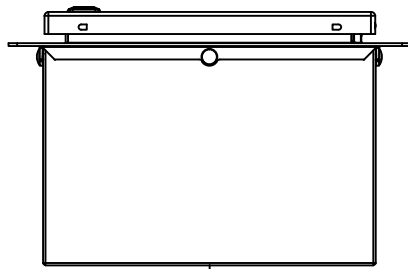

TOP

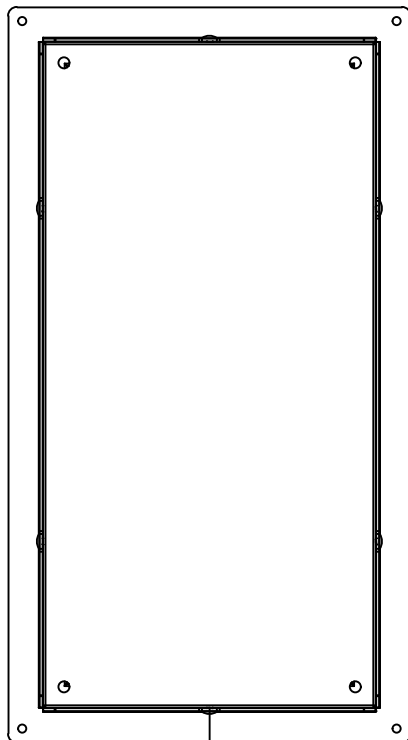

BACK

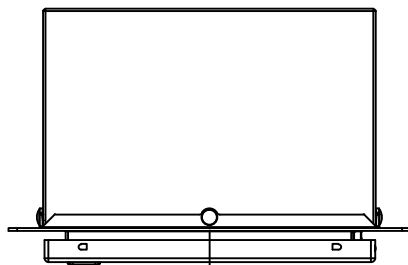

BOTTOM

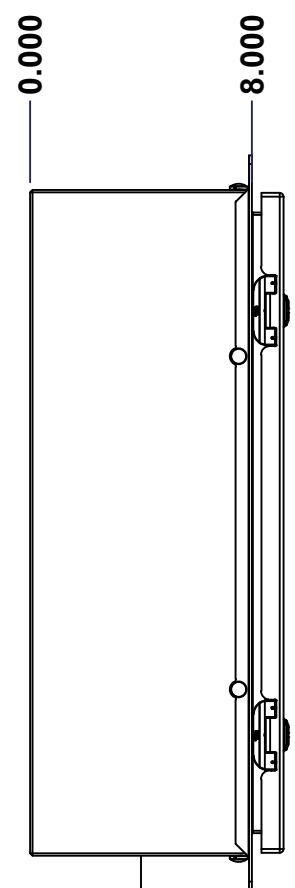

LEFT

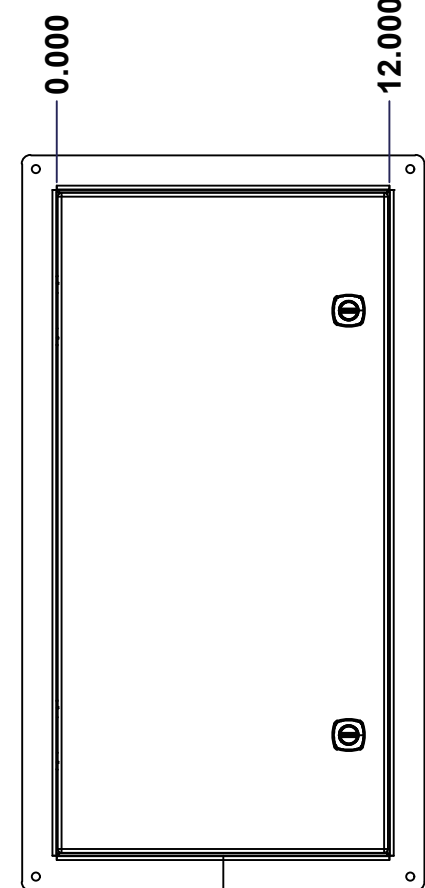

FRONT

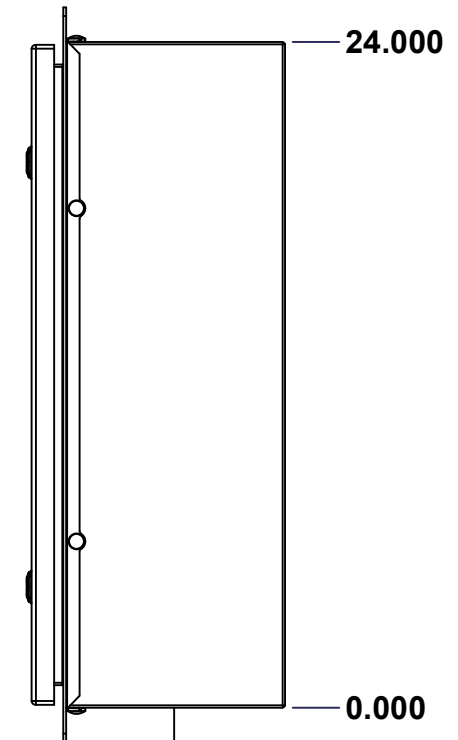

RIGHT

No.	Revisions	Date	By/Par

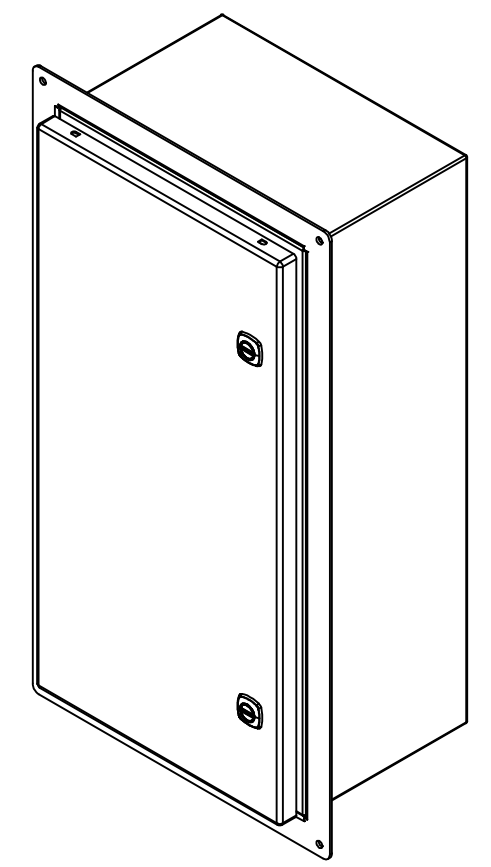

Isometric View

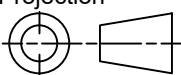

 Tél: (450) 979-4373 Fax: (450) 979-4626 www.exmweb.com		Flatness Aplatissement Max 3.0mm Projection 
Customer Client	Date	
Drawn By Dessiné Par	BoxCad: BoxCad	Date 19-Feb-14
Material Matière	16 Ga Cold Rolled A1008 CS Type B (1.4mm)	
Color Couleur	Asa-61 Grey	Finish Fini Smooth
Description	Detail Rev.	
5412ESFM 24" x 12" x 8" Assembly		
Part Number Numéro Pièce	Rev. 0	1 / 13
5412ESFM241208		

SEE BILL OF MATERIAL ON LAST PAGE

This drawing is confidential and must not be reproduced or used without the consent of EXM

Ce dessin est confidentiel et ne doit pas être reproduit ou utilisé sans le consentement de EXM

NOTE	
ITEM	DESCRIPTION
1	NEMA 4, 12 Enclosure (IP66)
2	C/W Standard ground studs on box and cover
3	C/W Standard door stiffener
4	C/W Standard inner panel (Included)
5	C/W Standard inner panel mounting studs

No.	Revisions	Date	By/Par

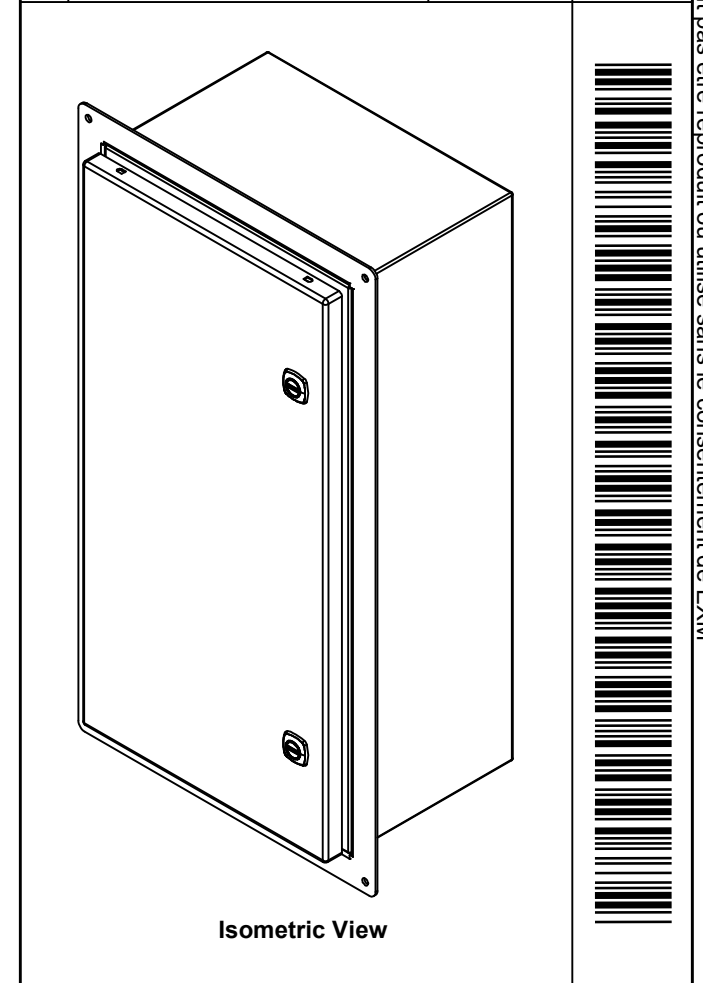

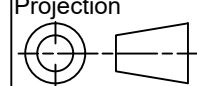
 Tél: (450) 979-4373 Fax: (450) 979-4626 www.exmweb.com	Flatness Aplatissement
	Max 3.0mm
Projection	
Customer Client	Date
Drawn By Dessiné Par BoxCad: BoxCad	Date 19-Feb-14
Material Matière 16 Ga Cold Rolled A1008 CS Type B (1.4mm)	

PACKING		
ITEM	QTY	DESCRIPTION
Cardboard sleeve	2	Top and Bottom
Cardboard strip	2	Between back of enclosure and inner panel
Plastic bag	1	To protect cover surface and inside gasket
Plastic strap - Black	2	To Squeeze the 2 cardboard sleeve together
Packaging label	1	White label with product number

1	881 SP2412G	0	881 SP - Inner Panel
2	STK-K-01320	0	5412 ES Inner Panel Accessory Kit
1	STK-K-01800	5	5412 ES Accessory Kit
1	5412ESFM241208C	0	5412ESFM 24" x 12" Cover
1	5412ESFM241208B	0	5412ESFM 24" x 12" x 8" Body
2	STK-Q-04050-08	0	M6 x 8mm Hexagon Socket Head Machine Screw
Qty	Part Number	Rev	Description
Parts List			

Color Couleur	Asa-61 Grey	Finish Fini	Smooth
Description	5412ESFM 24" x 12" x 8" Assembly		
Part Number Numéro Pièce	5412ESFM241208		Rev. 2
			0
			13

This drawing is confidential and must not be reproduced or used without the consent of EXM

Ce dessin est confidentiel et ne doit pas être reproduit ou utilisé sans le consentement de EXM

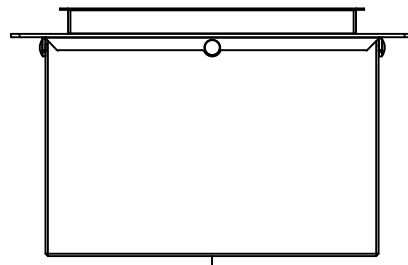

TOP

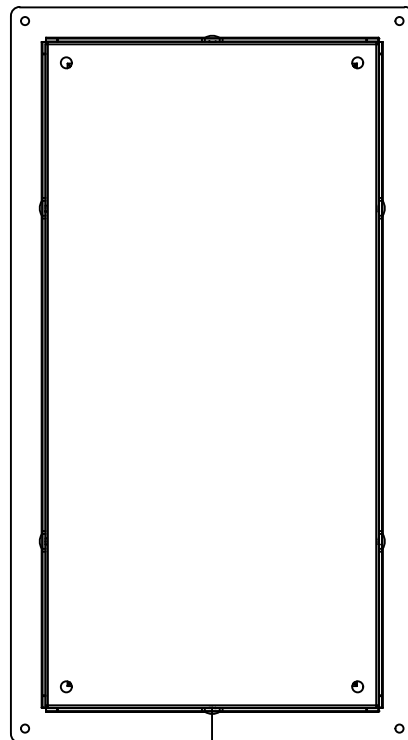

BACK

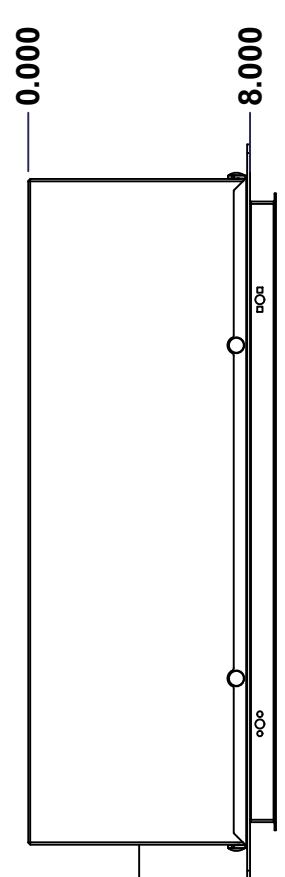

LEFT

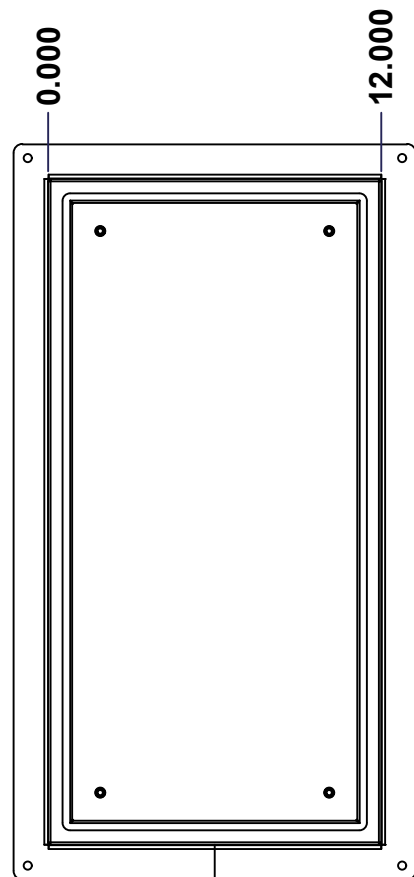

FRONT

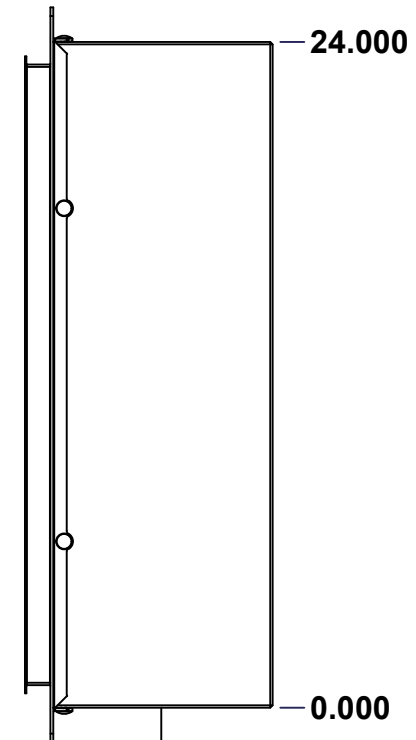

RIGHT

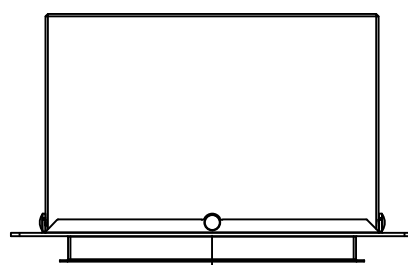

BOTTOM

No.	Revisions	Date	By/Par

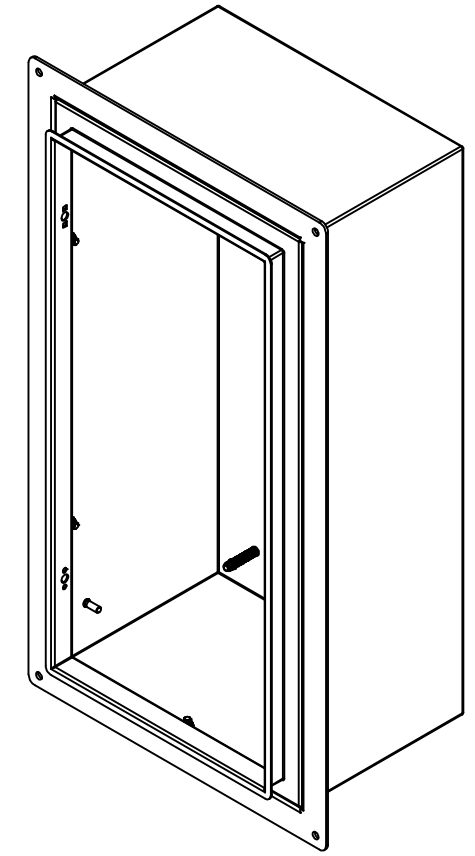

Isometric View

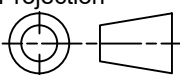

 Tél: (450) 979-4373 Fax: (450) 979-4626 www.exmweb.com		Flatness Aplatissement Max 3.0mm Projection 
Customer Client	Date	
Drawn By Dessiné Par	BoxCad: BoxCad	Date 19-Feb-14
Material Matière	16 Ga Cold Rolled A1008 CS Type B (1.4mm)	
Color Couleur	Asa-61 Grey	Finish Fini Smooth
Description 5412ESFM 24" x 12" x 8" Body		Detail Rev.
Part Number Numéro Pièce	Rev. 0	3 13

SEE BILL OF MATERIAL ON LAST PAGE

5412ESFM241208B

This drawing is confidential and must not be reproduced or used without the consent of EXM

Ce dessin est confidentiel et ne doit pas être reproduit ou utilisé sans le consentement de EXM

STANDARD FEATURES ARE NOT LISTED IN THIS HOLE TABLE			
HOLE TABLE - TOP VIEW (CUSTOM FEATURE ONLY)			
CUT-OUT	XDIM	YDIM	DESCRIPTION
1	6.000	7.514	RND Ø0.290

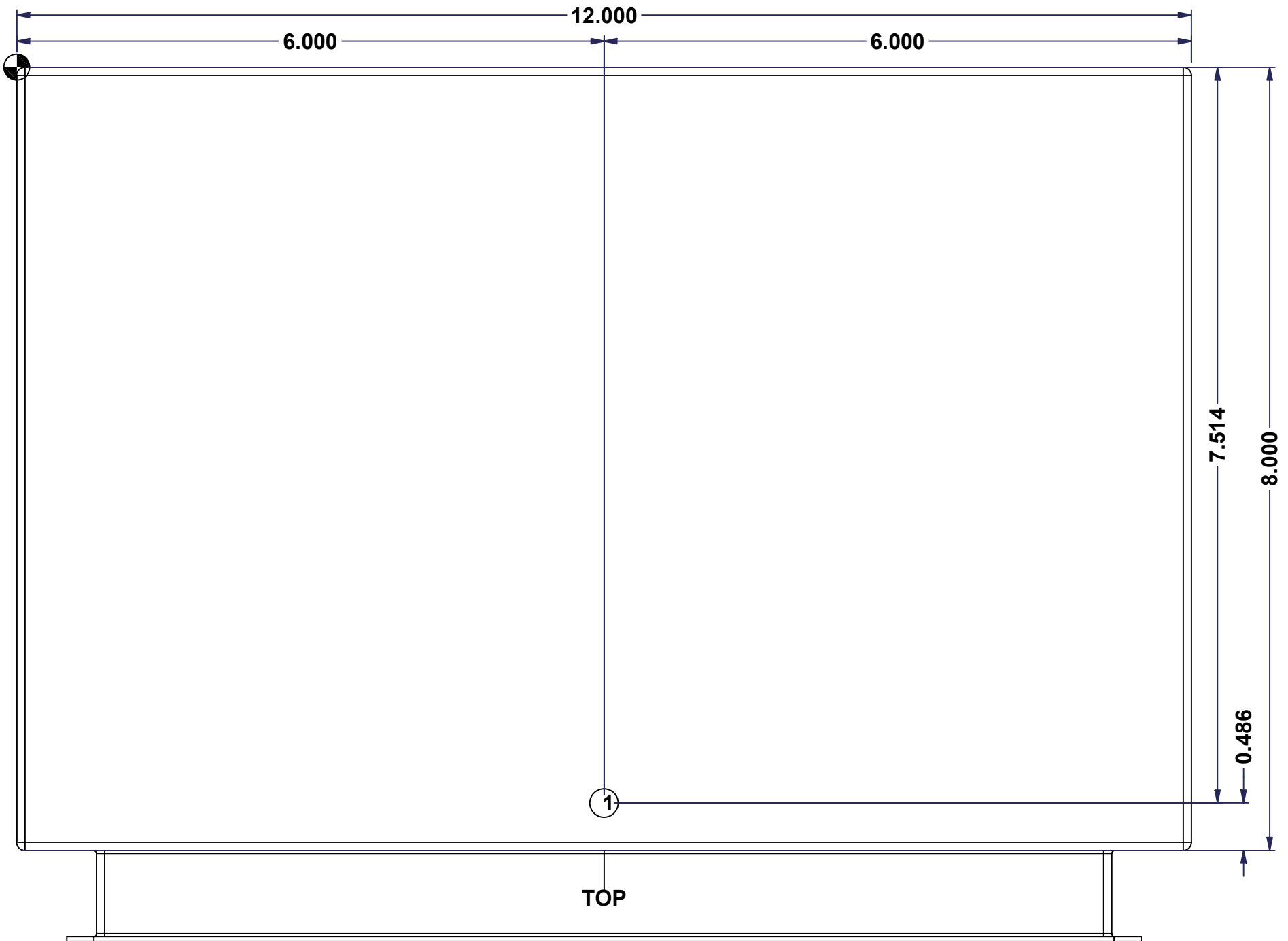

	Description	Status	
	5412ESFM 24" x 12" x 8" Body	(NULL)	
	Part Number Numéro Pièce	Rev.	4
	5412ESFM241208B	0	13

This drawing is confidential and must not be reproduced or used without the consent of EXM

Ce dessin est confidentiel et ne doit pas être reproduit ou utilisé sans le consentement de EXM

STANDARD FEATURES ARE NOT LISTED IN THIS HOLE TABLE			
HOLE TABLE - RIGHT VIEW (CUSTOM FEATURE ONLY)			
CUT-OUT	XDIM	YDIM	DESCRIPTION
1	7.514	18.000	RND Ø0.290
2	7.514	6.000	RND Ø0.290

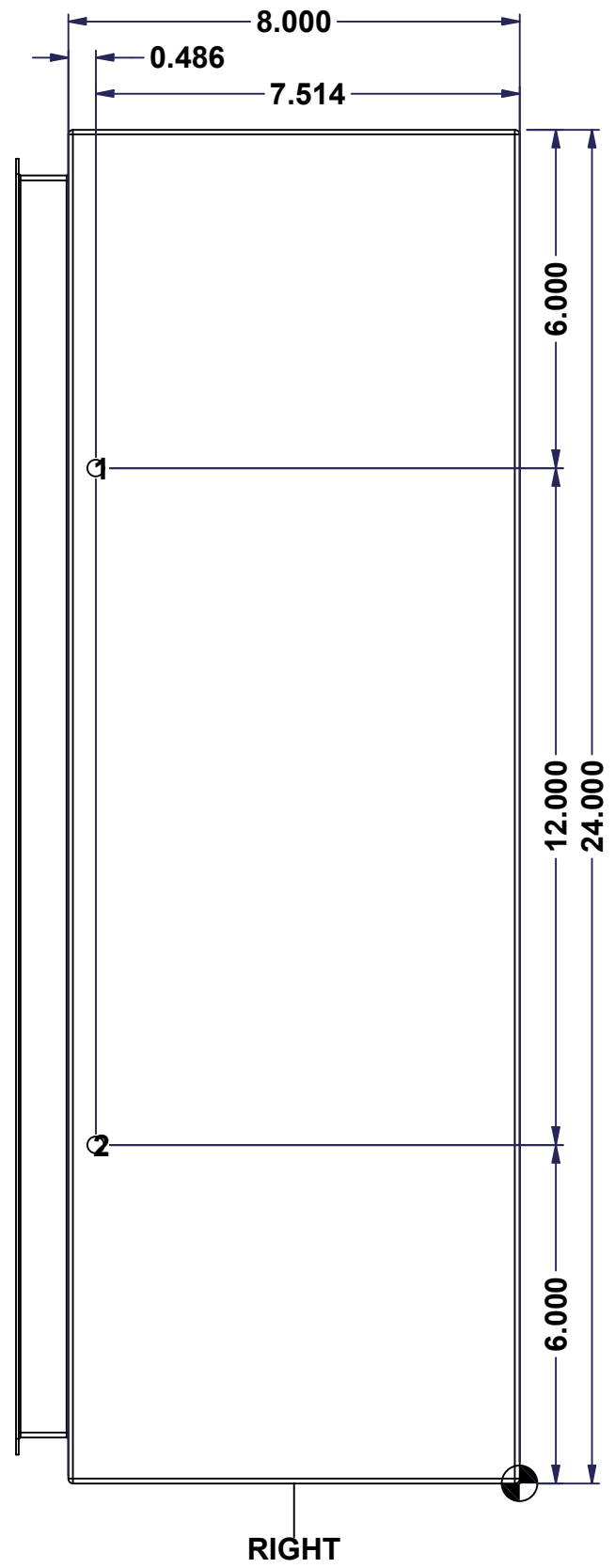

	Description	Status
	5412ESFM 24" x 12" x 8" Body	(NULL)
	Part Number Numéro Pièce	Rev.
	5412ESFM241208B	0
		5
		13

This drawing is confidential and must not be reproduced or used without the consent of EXM

Ce dessin est confidentiel et ne doit pas être reproduit ou utilisé sans le consentement de EXM

STANDARD FEATURES ARE NOT LISTED IN THIS HOLE TABLE			
HOLE TABLE - BOTTOM VIEW (CUSTOM FEATURE ONLY)			
CUT-OUT	XDIM	YDIM	DESCRIPTION
1	6.000	7.514	RND Ø0.290

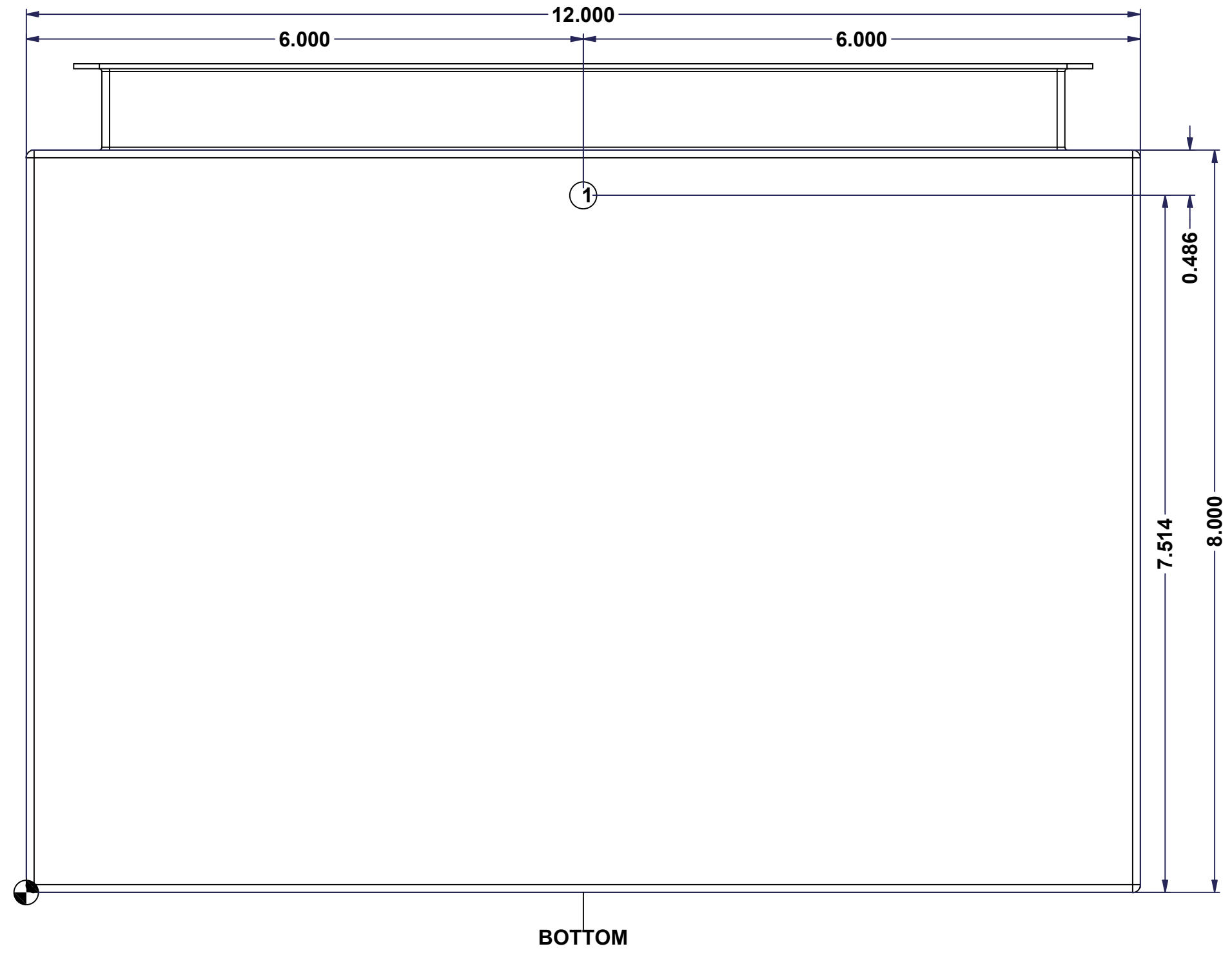

	Description	Status
	5412ESFM 24" x 12" x 8" Body	(NULL)
	Part Number Numéro Pièce	Rev.
	5412ESFM241208B	0
		6
		13

This drawing is confidential and must not be reproduced or used without the consent of EXM

Ce dessin est confidentiel et ne doit pas être reproduit ou utilisé sans le consentement de EXM

STANDARD FEATURES ARE NOT LISTED IN THIS HOLE TABLE

HOLE TABLE - LEFT VIEW (CUSTOM FEATURE ONLY)

CUT-OUT	XDIM	YDIM	DESCRIPTION
1	7.514	18.000	RND Ø0.290
2	7.514	6.000	RND Ø0.290
3	6.500	2.000	GND STUD M6 x 16mm (Inside)

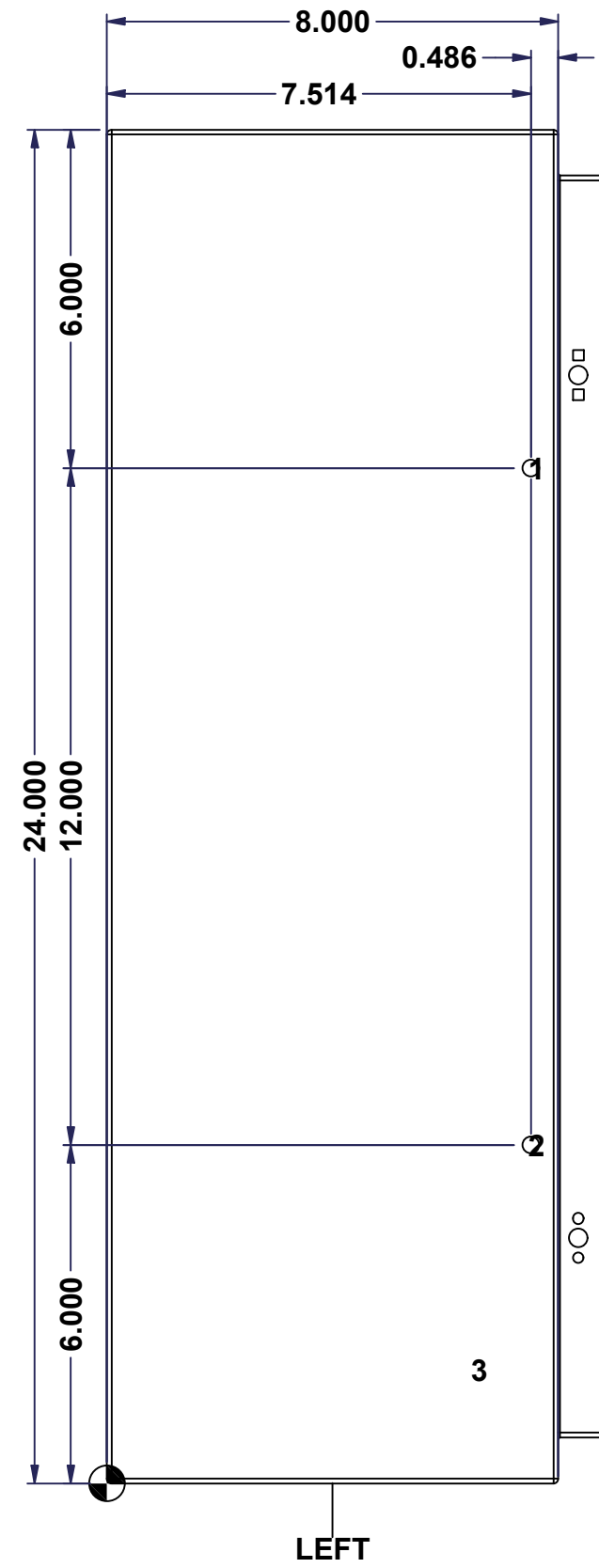

	Description	Status	
	5412ESFM 24" x 12" x 8" Body	(NULL)	
	Part Number Numéro Pièce	Rev.	7
	5412ESFM241208B	0	13

This drawing is confidential and must not be reproduced or used without the consent of EXM

Ce dessin est confidentiel et ne doit pas être reproduit ou utilisé sans le consentement de EXM

STANDARD FEATURES ARE NOT LISTED IN THIS HOLE TABLE

HOLE TABLE - BACK VIEW (CUSTOM FEATURE ONLY)

CUT-OUT	XDIM	YDIM	DESCRIPTION
1	1.875	1.875	IP STUD M8 x 35mm (Inside)
2	1.875	22.125	IP STUD M8 x 35mm (Inside)
3	10.125	22.125	IP STUD M8 x 35mm (Inside)
4	10.125	1.875	IP STUD M8 x 35mm (Inside)

5	11.250	0.750	RND Ø0.390
6	11.250	23.250	RND Ø0.390
7	0.750	23.250	RND Ø0.390
8	0.750	0.750	RND Ø0.390

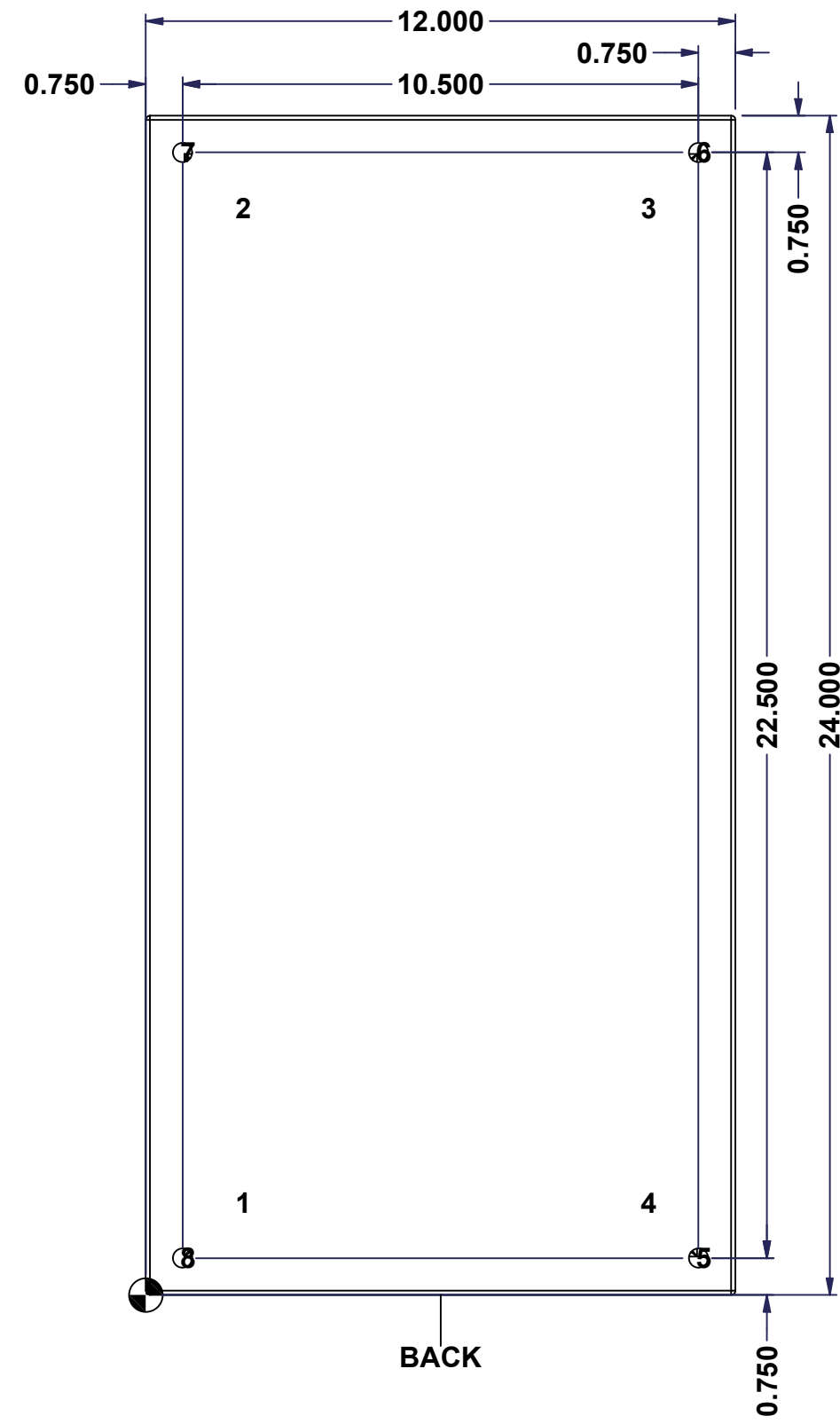

	Description	Status
	5412ESFM 24" x 12" x 8" Body	(NULL)
	Part Number Numéro Pièce	Rev.
	5412ESFM241208B	0 / 8
		13

This drawing is confidential and must not be reproduced or used without the consent of EXM

Ce dessin est confidentiel et ne doit pas être reproduit ou utilisé sans le consentement de EXM

STANDARD FEATURES ARE NOT LISTED IN THIS HOLE TABLE

HOLE TABLE - FRONT VIEW (CUSTOM FEATURE ONLY)

CUT-OUT	XDIM	YDIM	DESCRIPTION
1	14.000	0.500	RND Ø0.290
2	14.000	26.000	RND Ø0.290
3	0.500	26.000	RND Ø0.290
4	0.500	0.500	RND Ø0.290

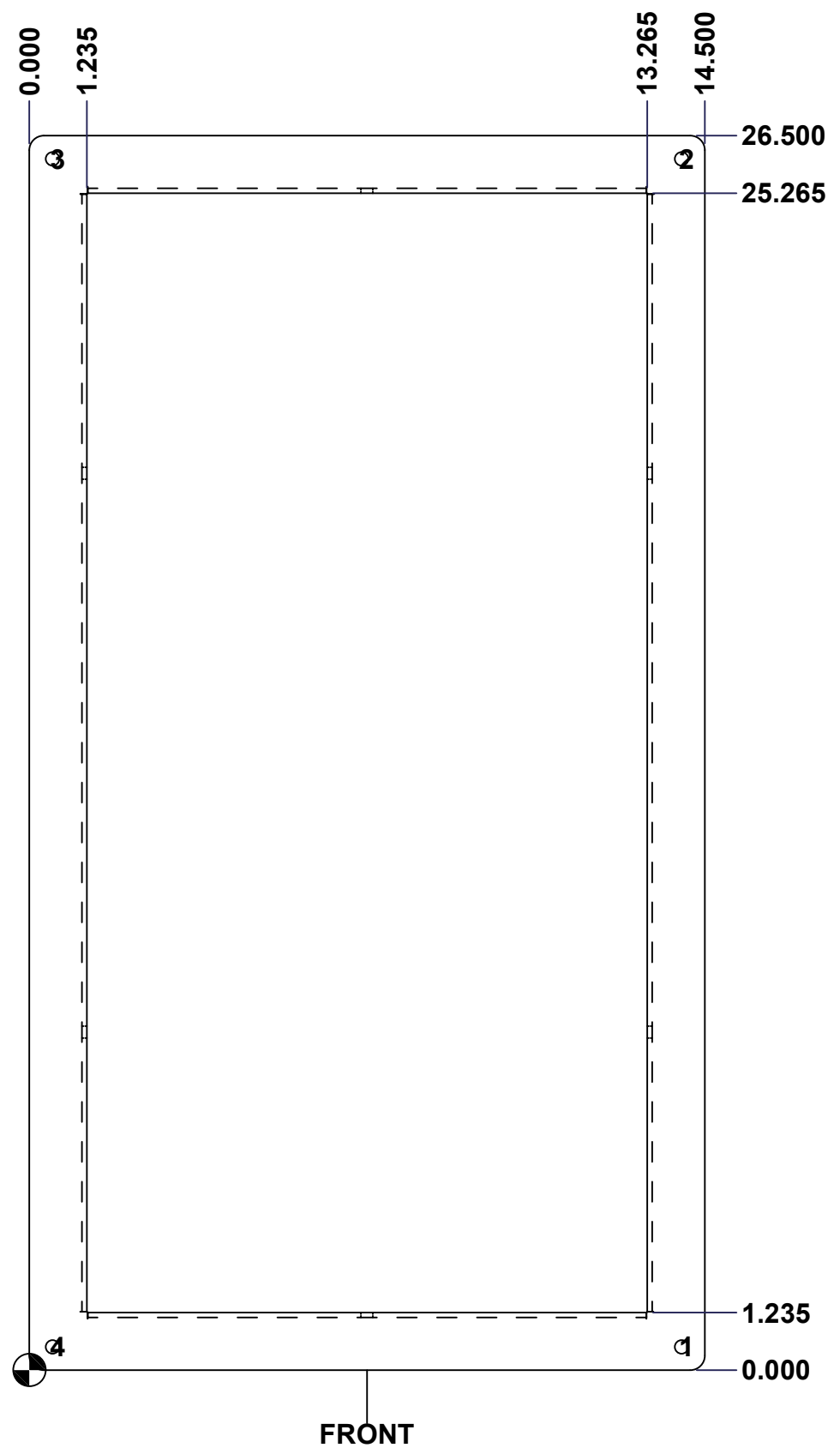

	Description	Status
	5412ESFM 24" x 12" x 8" Flange	(NULL)
Part Number Numéro Pièce 5412ESFM241208B	Rev.	9
	0	13

This drawing is confidential and must not be reproduced or used without the consent of EXM

Ce dessin est confidentiel et ne doit pas être reproduit ou utilisé sans le consentement de EXM

No.	Revisions	Date	By/Par

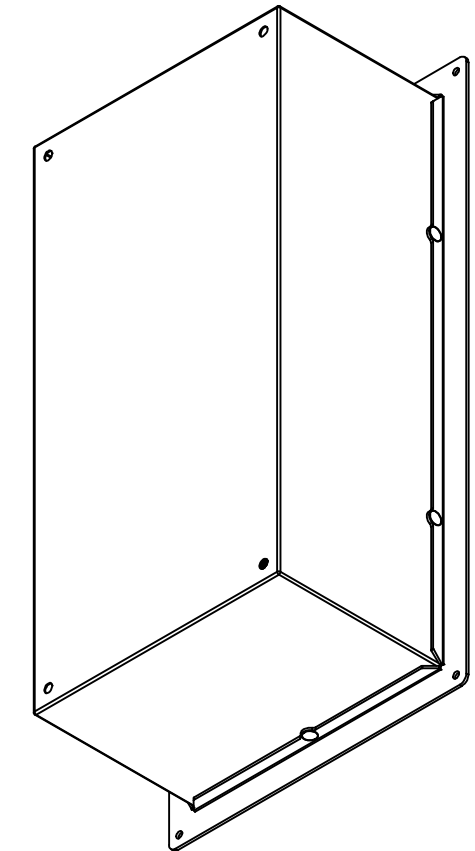

Isometric View

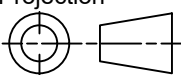

 Tél: (450) 979-4373 Fax: (450) 979-4626 www.exmweb.com		Flatness Aplatissement Max 3.0mm Projection 
Customer Client	Date	
Drawn By Dessiné Par	BoxCad: BoxCad	Date 19-Feb-14
Material Matière	16 Ga Cold Rolled A1008 CS Type B (1.4mm)	
Color Couleur	Asa-61 Grey	Finish Fini Smooth
Description		Detail Rev.
5412ESFM 24" x 12" x 8" Body		
Part Number Numéro Pièce	Rev.	10
5412ESFM241208B	0	13

Qty	Part Number	Rev	Description
1	STK-Q-16080	0	Ground Stud M6 x 16mm Steel
1	5412ESFM241208F	0	5412ESFM 24" x 12" x 8" Flange
1	STK-P-02400S	0	Powder Paint (Asa-61 Grey / Smooth)
4	STK-Q-16005	1	Stud M8 x 35mm (No Paint Cap Required)
1	5412ESFM241208B-P	0	5412ESFM 24" x 12" x 8" Body Part
Parts List			

This drawing is confidential and must not be reproduced or used without the consent of EXM

Ce dessin est confidentiel et ne doit pas être reproduit ou utilisé sans le consentement de EXM

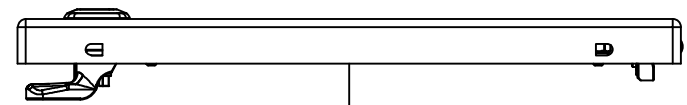

TOP

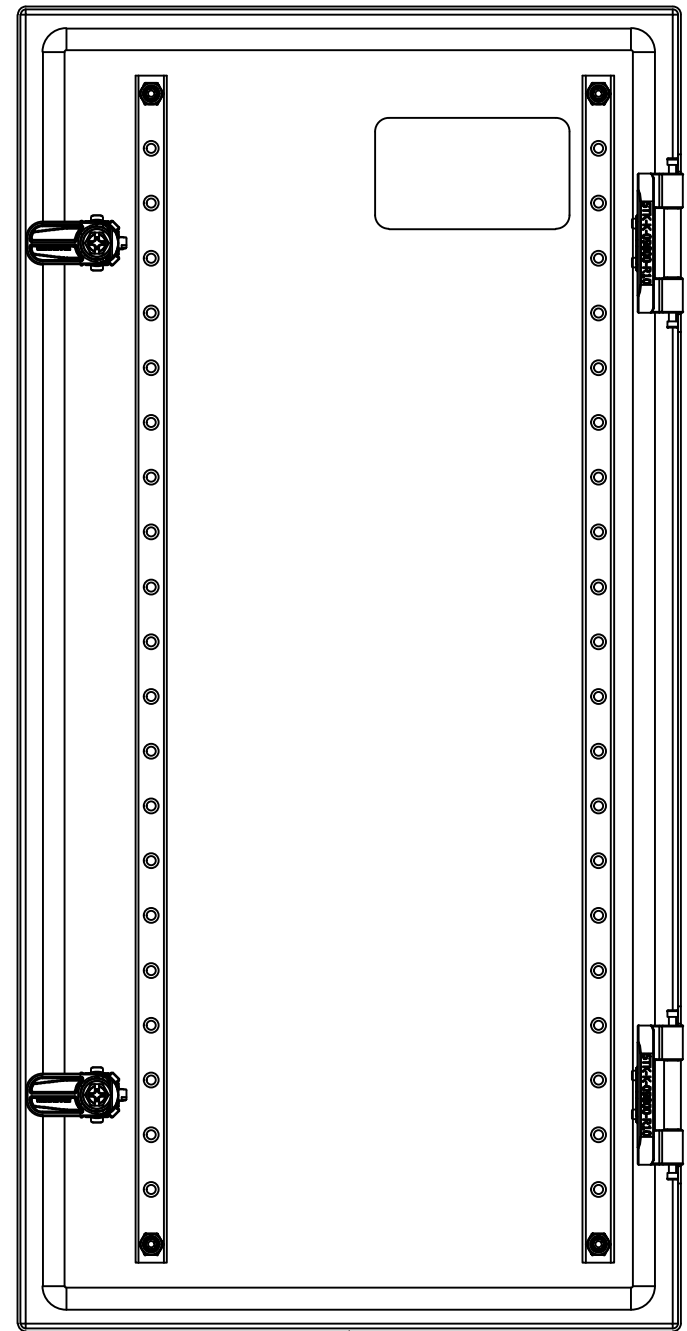

BACK

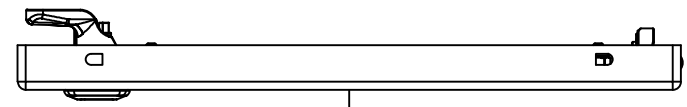

BOTTOM

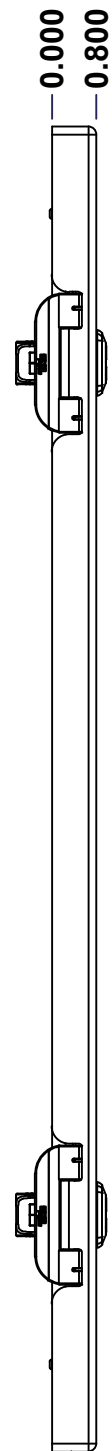

LEFT

0.000
0.800

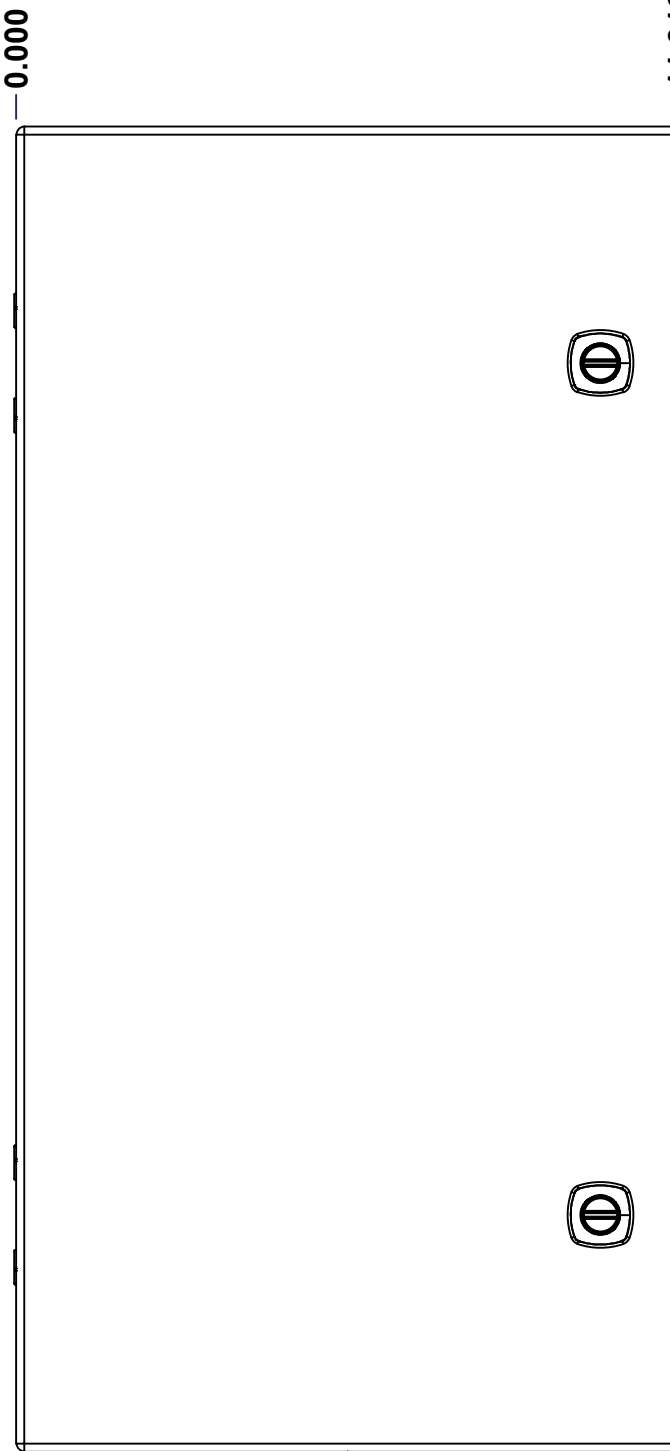

FRONT

0.000

11.918

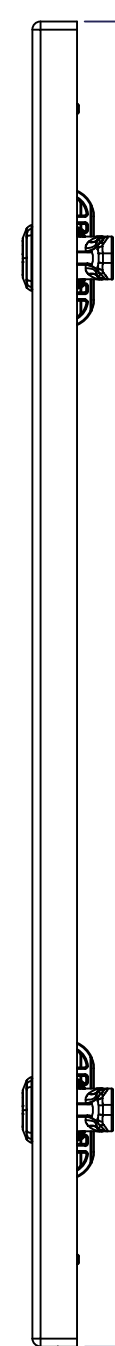

RIGHT

23.803

0.000

No.	Revisions	Date	By/Par

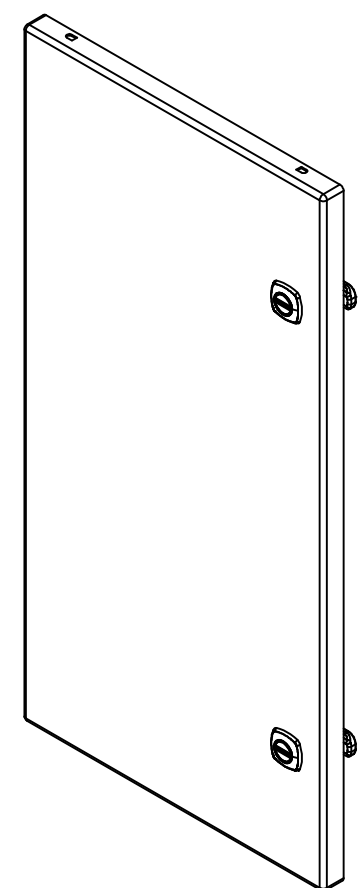

Isometric View



Tél: (450) 979-4373
Fax: (450) 979-4626
www.exmweb.com

Flatness
Aplatissement

Max 3.0mm

Projection

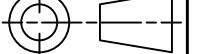

Customer Client	Date
Drawn By Dessiné Par BoxCad: BoxCad	Date 19-Feb-14
Material Matière 16 Ga Cold Rolled A1008 CS Type B (1.4mm)	
Color Couleur Asa-61 Grey	Finish Fini Smooth

Description 5412ESFM 24" x 12" Cover	Detail Rev.
---	-------------

Part Number Numéro Pièce	Rev.	11
5412ESFM241208C	0	13

SEE BILL OF MATERIAL ON LAST PAGE

This drawing is confidential and must not be reproduced or used without the consent of EXM

Ce dessin est confidentiel et ne doit pas être reproduit ou utilisé sans le consentement de EXM

STANDARD FEATURES ARE NOT LISTED IN THIS HOLE TABLE

HOLE TABLE - FRONT VIEW (CUSTOM FEATURE ONLY)

CUT-OUT	XDIM	YDIM	DESCRIPTION
1	1.486	1.567	STUD M6 x 18mm (Inside)
2	1.486	22.236	STUD M6 x 18mm (Inside)
3	9.517	22.236	STUD M6 x 18mm (Inside)
4	9.517	1.567	STUD M6 x 18mm (Inside)

5	10.494	4.250	LOCK 880 SCQ4-SL @ 0.0°
6	3.750	20.803	LABEL_EXM (Inside)
7	10.494	19.553	LOCK 880 SCQ4-SL @ 0.0°

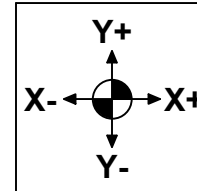
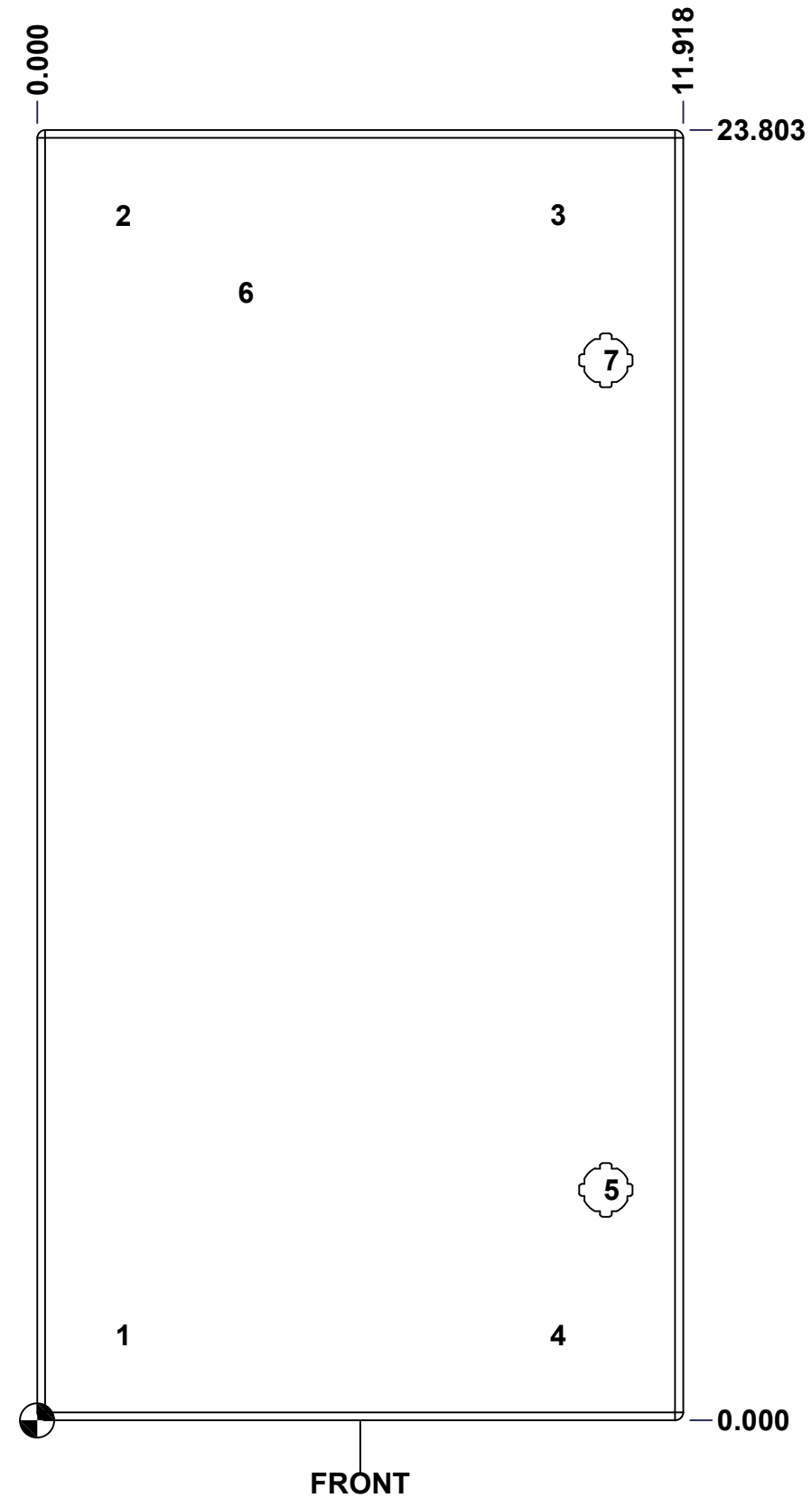

Description		Status	
5412ESFM 24" x 12" Cover		(NULL)	
Part Number Numéro Pièce		Rev.	12
5412ESFM241208C		0	13

This drawing is confidential and must not be reproduced or used without the consent of EXM

Ce dessin est confidentiel et ne doit pas être reproduit ou utilisé sans le consentement de EXM

No.	Revisions	Date	By/Par

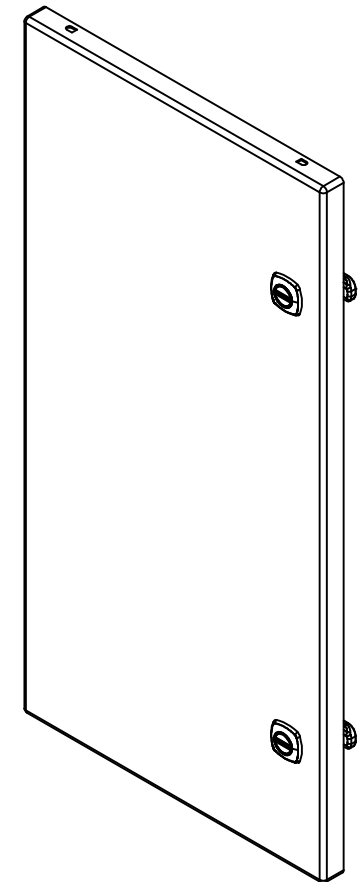

Isometric View



 Tél: (450) 979-4373 Fax: (450) 979-4626 www.exmweb.com	Flatness Aplatissement
	Max 3.0mm
	Projection
	

Customer Client	Date
Drawn By Dessiné Par	Date 19-Feb-14
Material Matière	BoxCad: BoxCad
	16 Ga Cold Rolled A1008 CS Type B (1.4mm)

Color Couleur	Asa-61 Grey	Finish Fini	Smooth
------------------	-------------	----------------	--------

Description	Detail Rev.
5412ESFM 24" x 12" Cover	

Part Number Numéro Pièce	Rev.	13
5412ESFM241208C	0	13

QTY	Part Number	Rev	Description
1	STK-S-00100	0	3.5" x 2" Silver Milar Flexcon Sticker
2	STK-K-12500	19	5412 ES 1/4 Turn Lock
1	STK-P-02400S	0	Powder Paint (Asa-61 Grey / Smooth)
2	STK-Q-46020-24	5	5412 ES Vertical Door Stiffener 24"
4	STK-Q-16055	1	M6 x 18mm Stud (No Paint Cap Required)
1	5412ESFM241208G	0	5412ESFM 24" x 12" Cover Gasket Part
1	5412ESFM241208C-P	0	5412ESFM 24" x 12" Cover Part
2	STK-K-09800	10	5412 ES Hinge with 2 Captive Hinge Pins
4	STK-Q-07220	1	M6 Nylon Insert Lock Nut
Parts List			

This drawing is confidential and must not be reproduced or used without the consent of EXM

Ce dessin est confidentiel et ne doit pas être reproduit ou utilisé sans le consentement de EXM

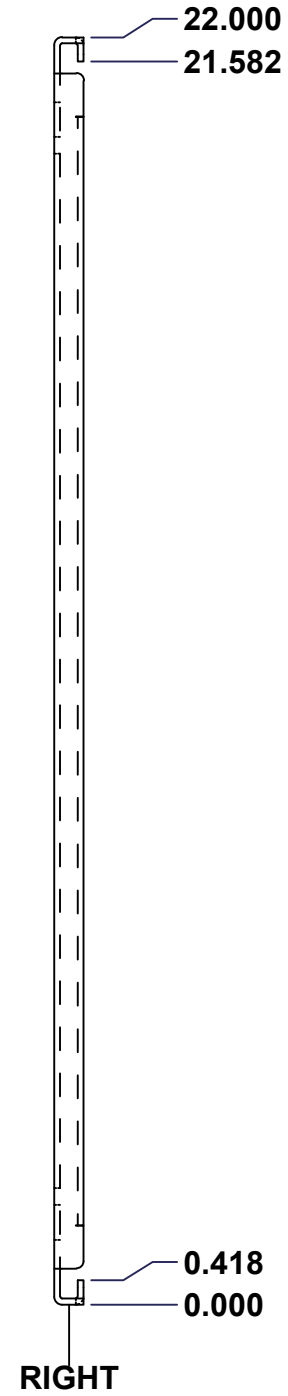
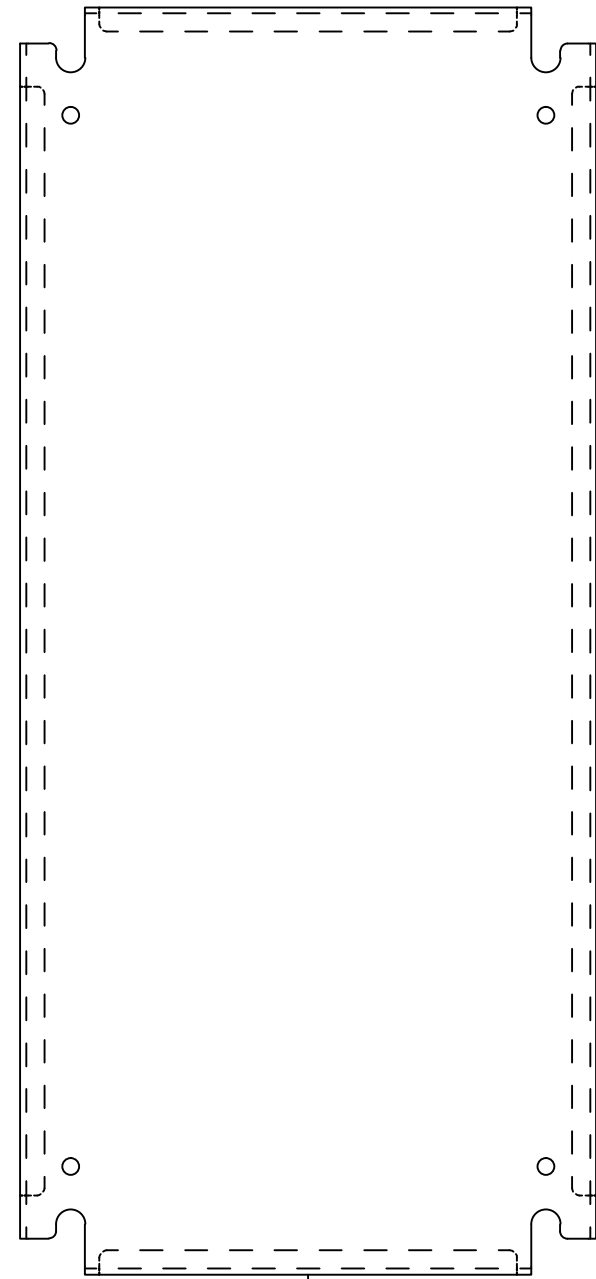
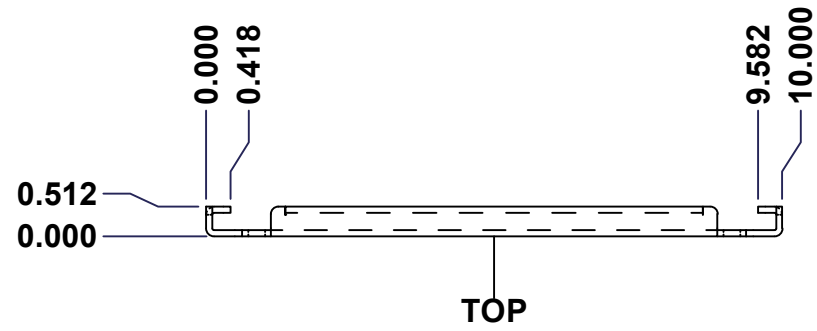

No.	Revisions	Date	By/Par

Isometric View

Tél: (450) 979-4373 Fax: (450) 979-4626 www.exmweb.com	Flatness Aplatissement
	Max 3.0mm
Projection	
Customer Client	Date
Drawn By Dessiné Par: BoxCad	Date: 23-Jan-07
Material Matière	See Part List
Color Couleur	See Part List
Finish Fini	See Part List
Description	Detail Rev.
881 SP - Inner Panel	
Part Number Numéro Pièce: 881 SP2412G	Rev. 1 0

Qty	Part Number	Rev	Description	Material	Color	Finish
1	881 SP2412G-P	0	881 SP - Inner Panel Part	12 Ga Galvanized	Unpainted	Galvanized

Parts List

This drawing is confidential and must not be reproduced or used without the consent of EXM

Ce dessin est confidentiel et ne doit pas être reproduit ou utilisé sans le consentement de EXM

Table 1			FRONT VIEW
CUT-OUT	XDIM	YDIM	DESCRIPTION
1	0.875	1.875	GROUND HOLE (RND Ø0.290)
2	9.125	1.875	GROUND HOLE (RND Ø0.290)
3	0.875	20.125	GROUND HOLE (RND Ø0.290)
4	9.125	20.125	GROUND HOLE (RND Ø0.290)

All knockouts are actual size / Les disques défonçables sont grandeur réel

No.	Revisions	Date	By/Par

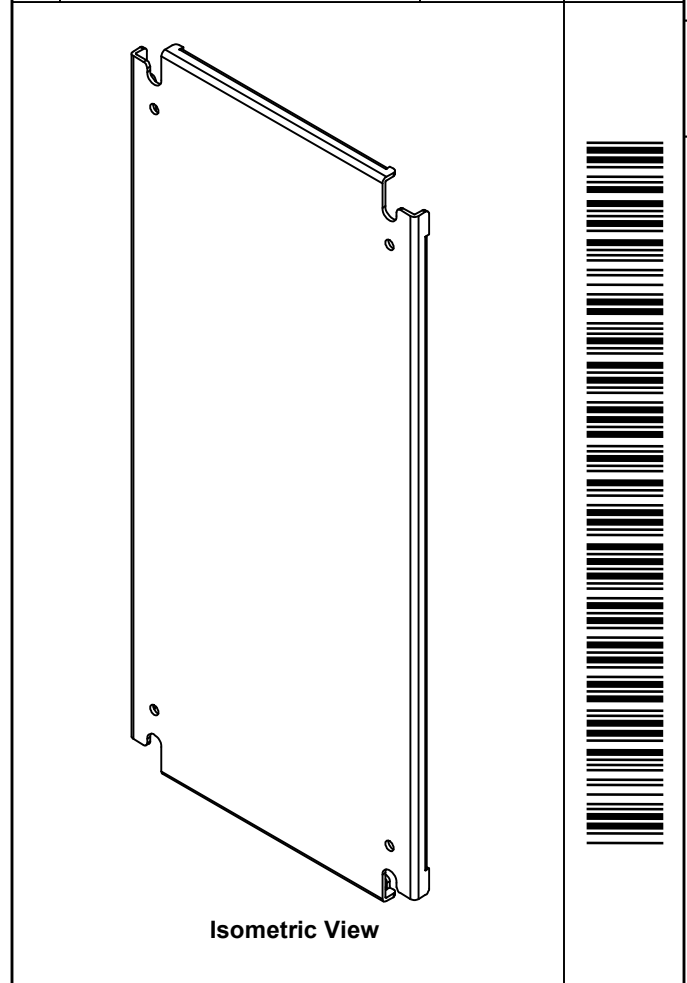
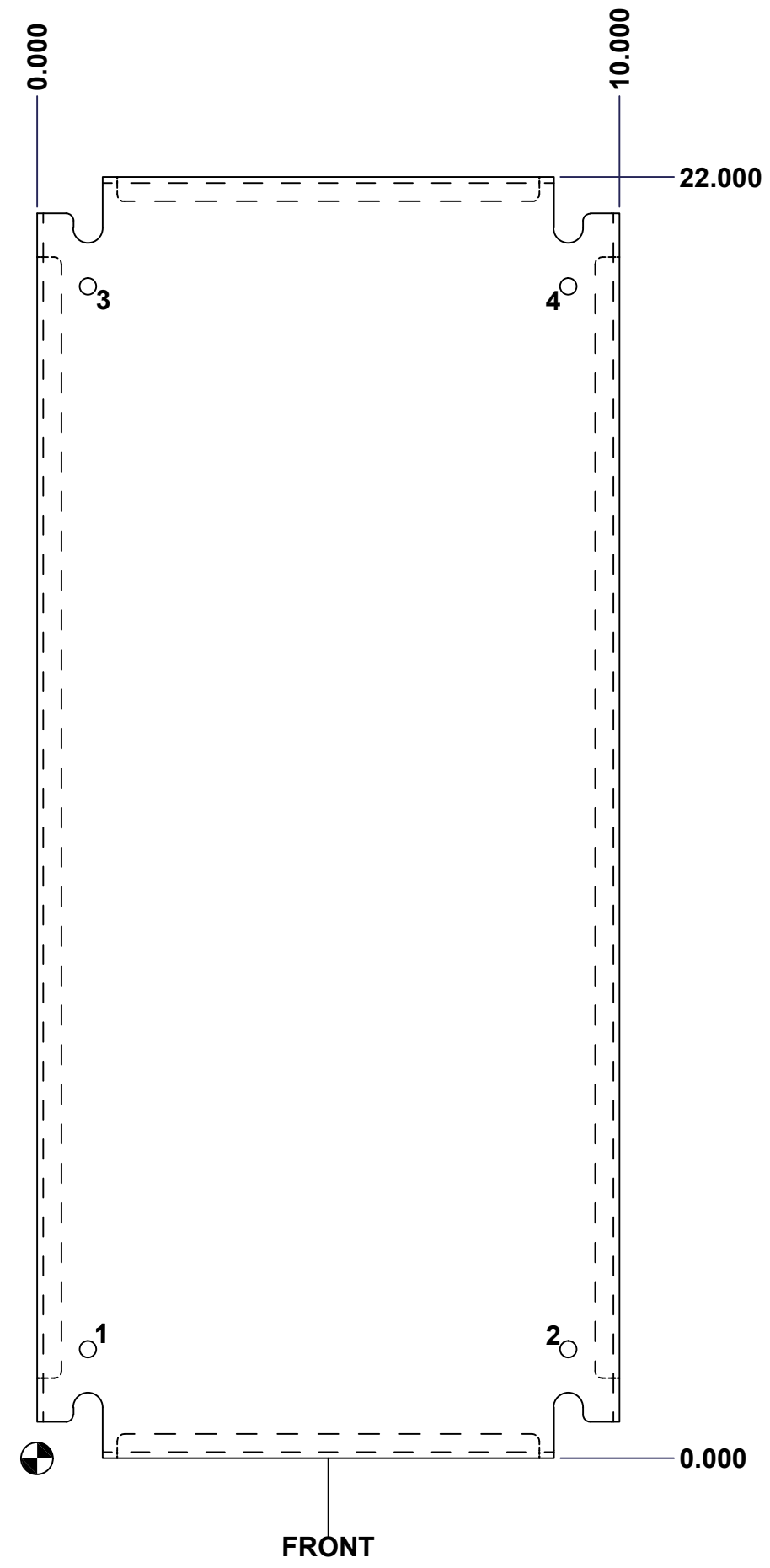

	Tél: (450) 979-4373 Fax: (450) 979-4626 www.exmweb.com	Flatness Aplatissement	Max 3.0mm
		Projection	
Customer Client		Date	
Drawn By Dessiné Par	BoxCad	Date	23-Jan-07
Material Matière	See Part List		
Color Couleur	See Part List	Finish Fini	See Part List
Description	881 SP - Inner Panel		Detail Rev.
Part Number Numéro Pièce	881 SP2412G		Rev. 2 0