

This drawing is confidential and must not be reproduced or used without the consent of EXM

Ce dessin est confidentiel et ne doit pas être reproduit ou utilisé sans le consentement de EXM

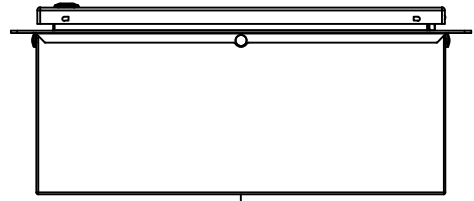

TOP

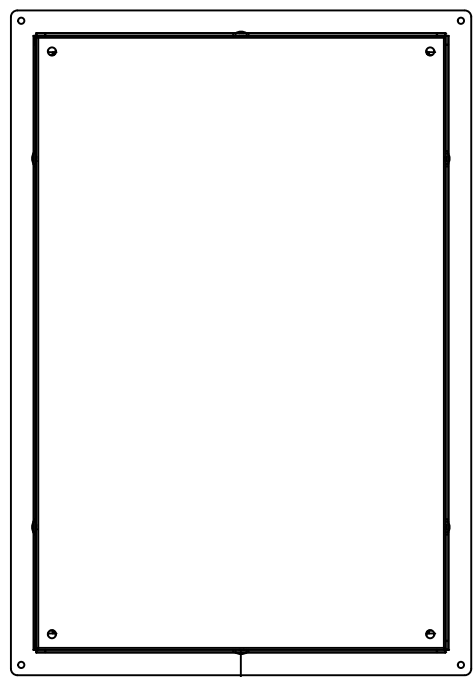

BACK

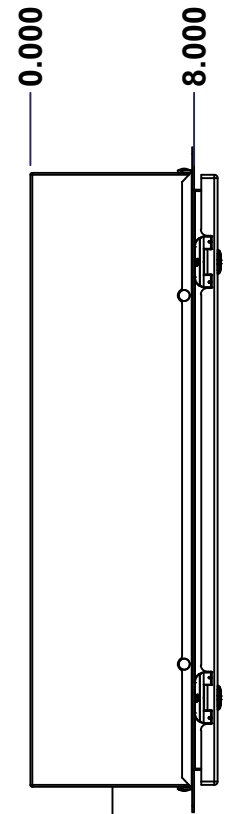

LEFT

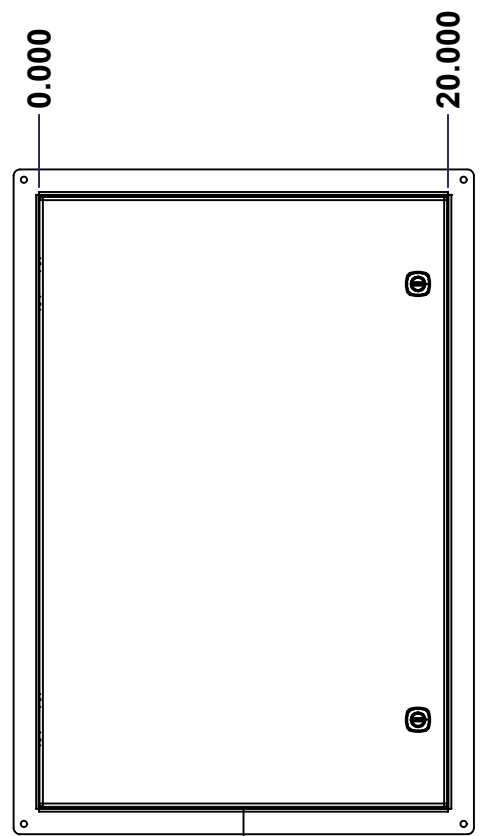

FRONT

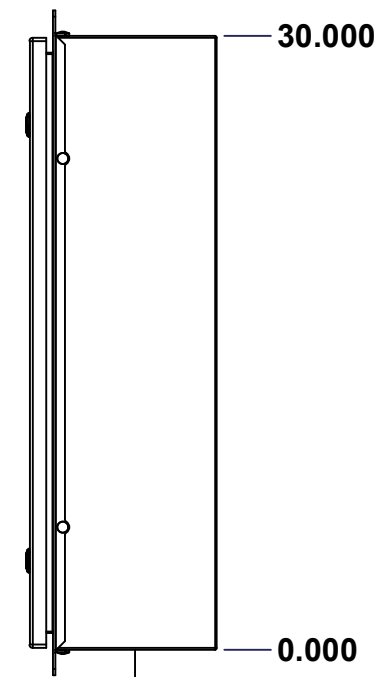

RIGHT

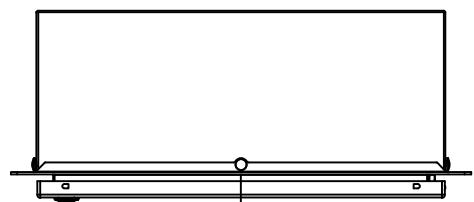

BOTTOM

No.	Revisions	Date	By/Par

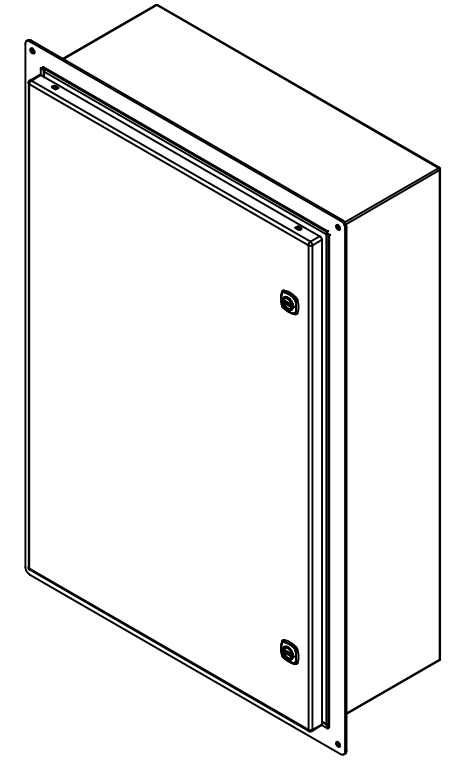

Isometric View



Tél: (450) 979-4373
 Fax: (450) 979-4626
www.exmweb.com

Flatness
Aplatissement
Max 3.0mm
Projection

Customer Client	Date
Drawn By / Dessiné Par: BoxCad: BoxCad	Date: 23-Dec-24
Material / Matière: 16 Ga Cold Rolled A1008 CS Type B (1.4mm)	

Color / Couleur: Asa-61 Grey	Finish / Fini: Smooth
------------------------------	-----------------------

Description: 5412ESFM 30" x 20" x 8" Assembly	Detail Rev.
---	-------------

Part Number / Numéro Pièce: 5412ESFM302008TH	Rev. 0	1
--	--------	---

SEE BILL OF MATERIAL ON LAST PAGE

This drawing is confidential and must not be reproduced or used without the consent of EXM

Ce dessin est confidentiel et ne doit pas être reproduit ou utilisé sans le consentement de EXM

NOTE	
ITEM	DESCRIPTION
1	NEMA 4, 12 Enclosure (IP66)
2	C/W Standard ground studs on box and cover
3	C/W Standard door stiffener
4	C/W Standard inner panel (Included)
5	C/W Standard inner panel mounting studs
6	C/W R5 Insulation (Installed aluminum visible)

No.	Revisions	Date	By/Par

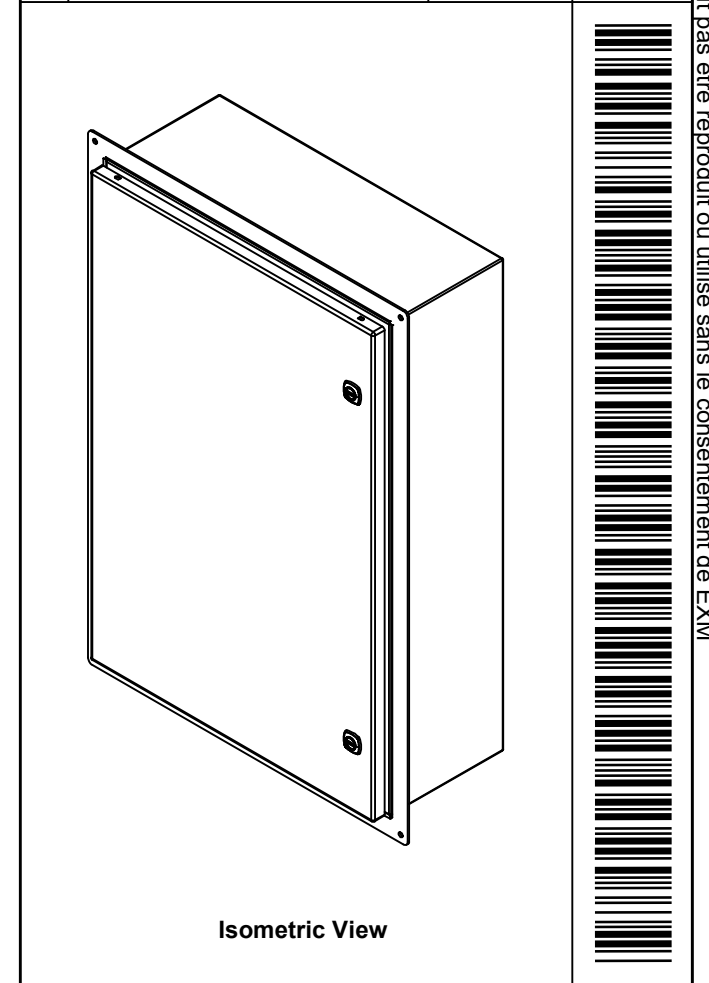

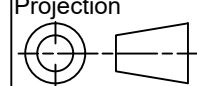
 Tél: (450) 979-4373 Fax: (450) 979-4626 www.exmweb.com	Flatness Aplatissement
	Max 3.0mm
Projection	
Customer Client	Date
Drawn By Dessiné Par BoxCad: BoxCad	Date 23-Dec-24
Material Matière 16 Ga Cold Rolled A1008 CS Type B (1.4mm)	

PACKING		
ITEM	QTY	DESCRIPTION
Cardboard sleeve	2	Top and Bottom
Cardboard strip	2	Between back of enclosure and inner panel
Plastic bag	1	To protect cover surface and inside gasket
Plastic strap - Black	2	To Squeeze the 2 cardboard sleeve together
Packaging label	1	White label with product number

4	STK-Q-00600	2	M12 to M8 Adaptor
1	881 SP3020G	0	881 SP - Inner Panel
1	STK-K-01800	5	5412 ES Accessory Kit
1	5412ESFM302008THC	0	5412ESFM 30" x 20" Cover
1	5412ESFM302008THB	0	5412ESFM 30" x 20" x 8" Body
2	STK-Q-04050-08	0	M6 x 8mm Hexagon Socket Head Machine Screw
Qty	Part Number	Rev	Description
Parts List			

Color Couleur	Asa-61 Grey	Finish Fini	Smooth
Description	5412ESFM 30" x 20" x 8" Assembly		
Part Number Numéro Pièce	5412ESFM302008TH		Rev. 2
			0
			19

This drawing is confidential and must not be reproduced or used without the consent of EXM

Ce dessin est confidentiel et ne doit pas être reproduit ou utilisé sans le consentement de EXM

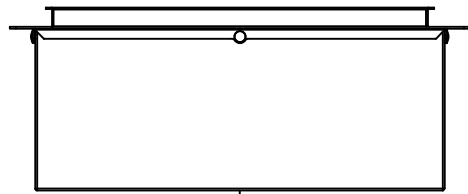

TOP

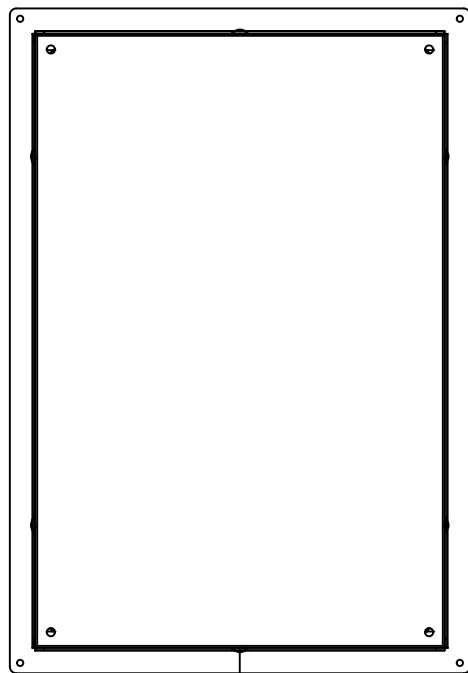

BACK

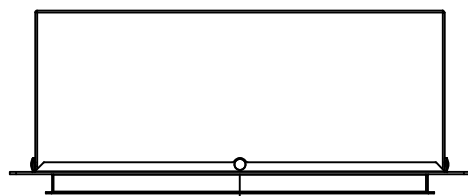

BOTTOM

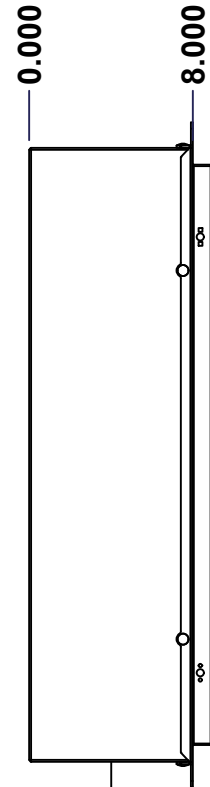

LEFT

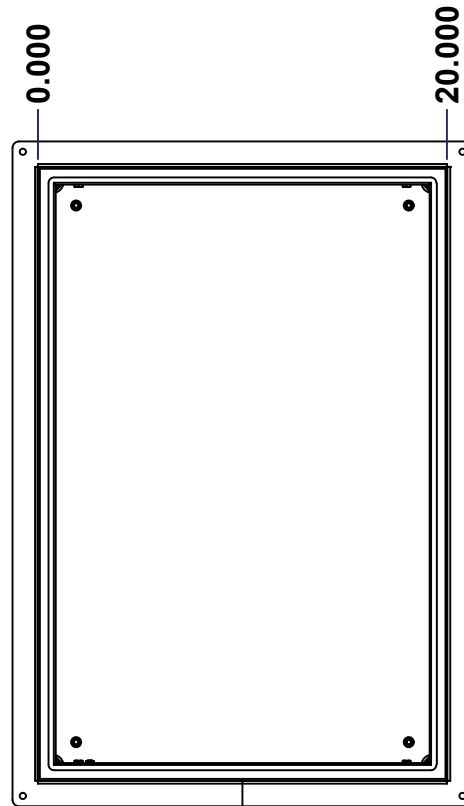

FRONT

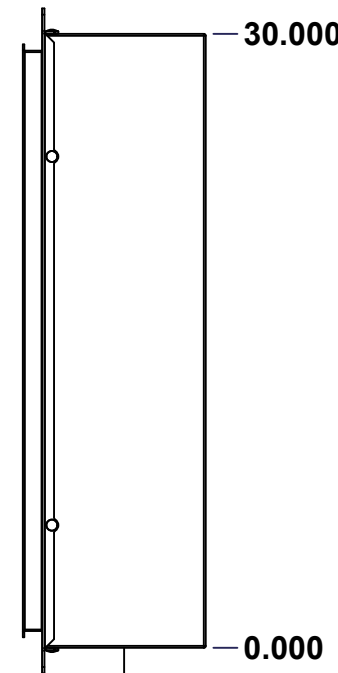

RIGHT

No.	Revisions	Date	By/Par

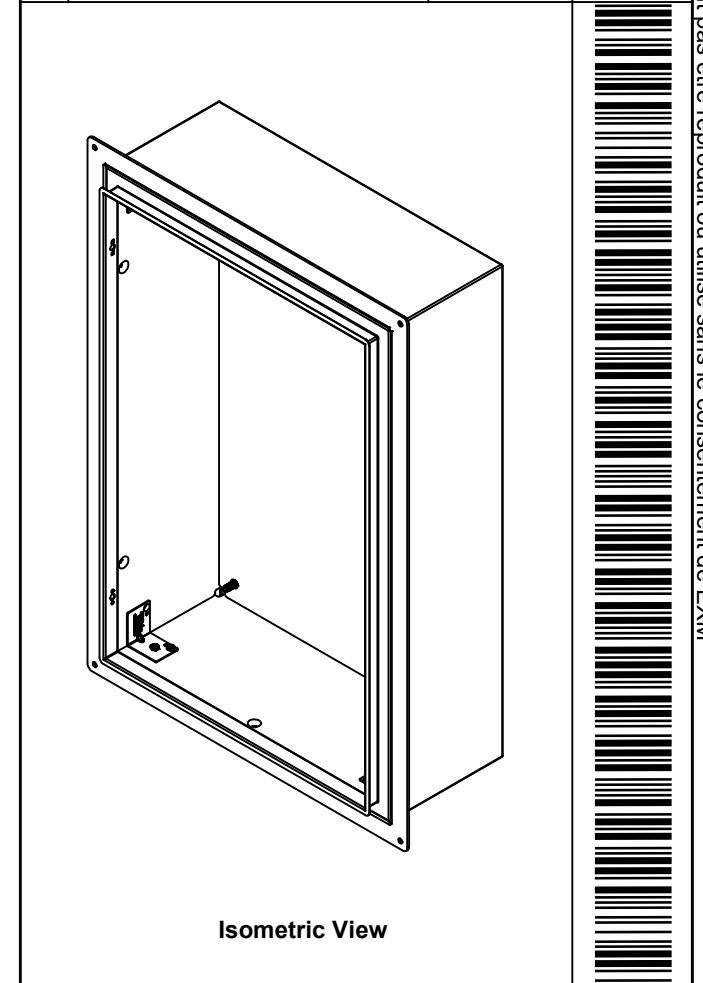

Isometric View

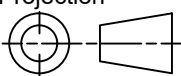

 Tél: (450) 979-4373 Fax: (450) 979-4626 www.exmweb.com		Flatness Aplatissement Max 3.0mm Projection 
Customer Client	Date	
Drawn By Dessiné Par	BoxCad: BoxCad	Date 23-Dec-24
Material Matière	16 Ga Cold Rolled A1008 CS Type B (1.4mm)	
Color Couleur	Asa-61 Grey	Finish Fini Smooth
Description	Detail Rev.	
5412ESFM 30" x 20" x 8" Body		
Part Number Numéro Pièce	Rev. 0	3 19

SEE BILL OF MATERIAL ON LAST PAGE

5412ESFM302008THB

This drawing is confidential and must not be reproduced or used without the consent of EXM

Ce dessin est confidentiel et ne doit pas être reproduit ou utilisé sans le consentement de EXM

STANDARD FEATURES ARE NOT LISTED IN THIS HOLE TABLE			
HOLE TABLE - TOP VIEW (CUSTOM FEATURE ONLY)			
CUT-OUT	XDIM	YDIM	DESCRIPTION
1	2.000	6.500	INSUL. STUD M6 x 18mm (Inside)
2	18.000	6.500	INSUL. STUD M6 x 18mm (Inside)

3	10.000	7.514	RND Ø0.290

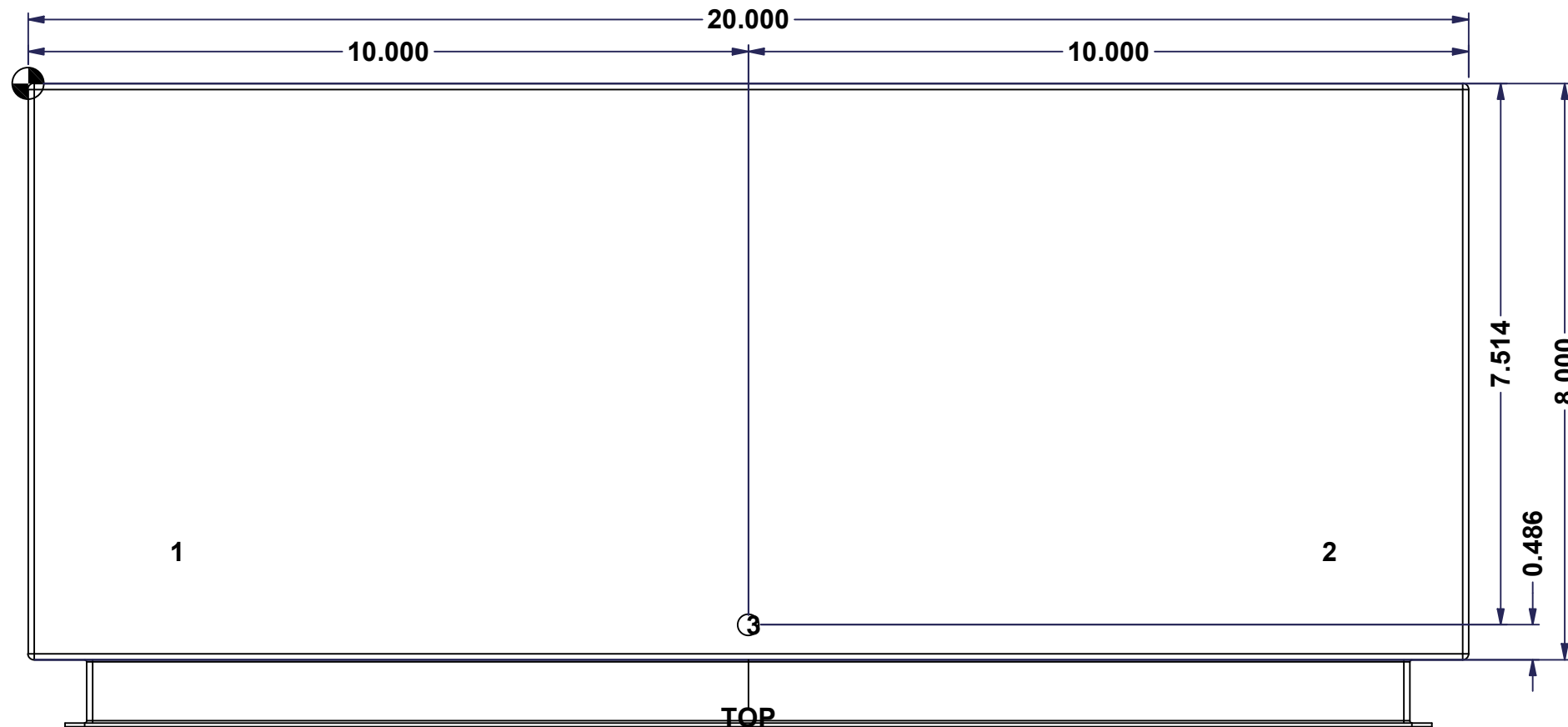

	Description	Status
	5412ESFM 30" x 20" x 8" Body	(NULL)
	Part Number Numéro Pièce	Rev.
	5412ESFM302008THB	0
		4
		19

This drawing is confidential and must not be reproduced or used without the consent of EXM

Ce dessin est confidentiel et ne doit pas être reproduit ou utilisé sans le consentement de EXM

STANDARD FEATURES ARE NOT LISTED IN THIS HOLE TABLE			
HOLE TABLE - RIGHT VIEW (CUSTOM FEATURE ONLY)			
CUT-OUT	XDIM	YDIM	DESCRIPTION
1	7.514	24.000	RND Ø0.290
2	7.514	6.000	RND Ø0.290

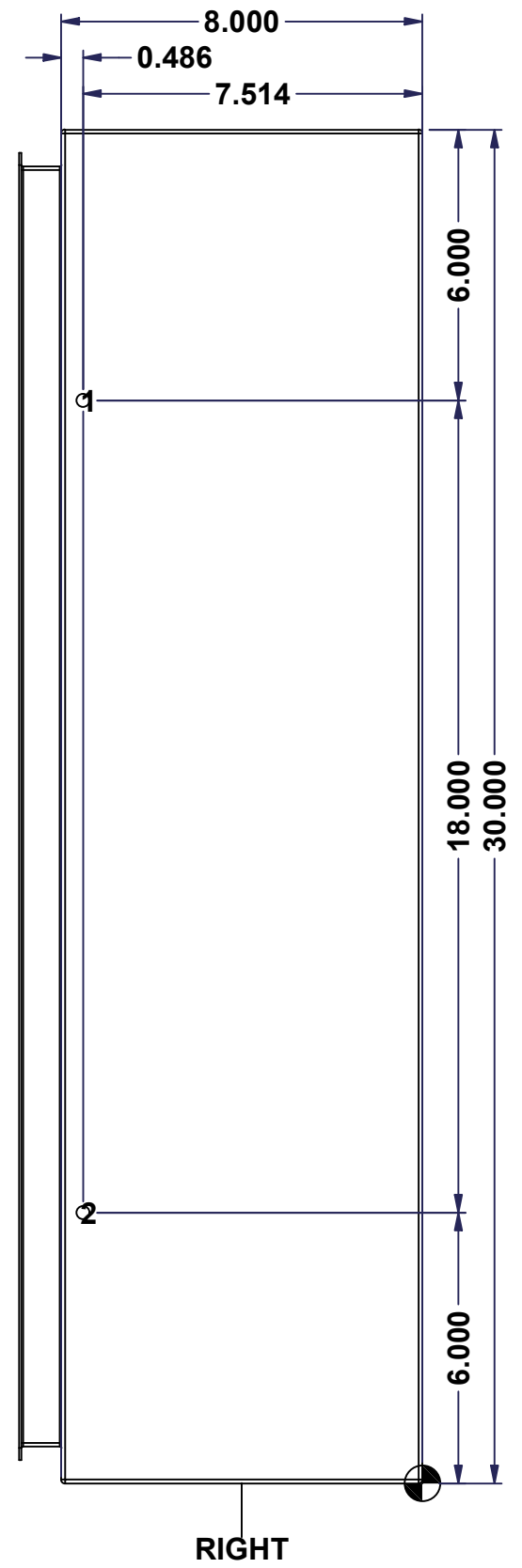

	Description	Status
	5412ESFM 30" x 20" x 8" Body	(NULL)
Part Number Numéro Pièce 5412ESFM302008THB	Rev.	5
	0	19

This drawing is confidential and must not be reproduced or used without the consent of EXM

Ce dessin est confidentiel et ne doit pas être reproduit ou utilisé sans le consentement de EXM

STANDARD FEATURES ARE NOT LISTED IN THIS HOLE TABLE

HOLE TABLE - BOTTOM VIEW (CUSTOM FEATURE ONLY)

CUT-OUT	XDIM	YDIM	DESCRIPTION
1	2.000	6.500	INSUL. STUD M6 x 18mm (Inside)
2	18.000	6.500	INSUL. STUD M6 x 18mm (Inside)

3	10.000	7.514	RND Ø0.290

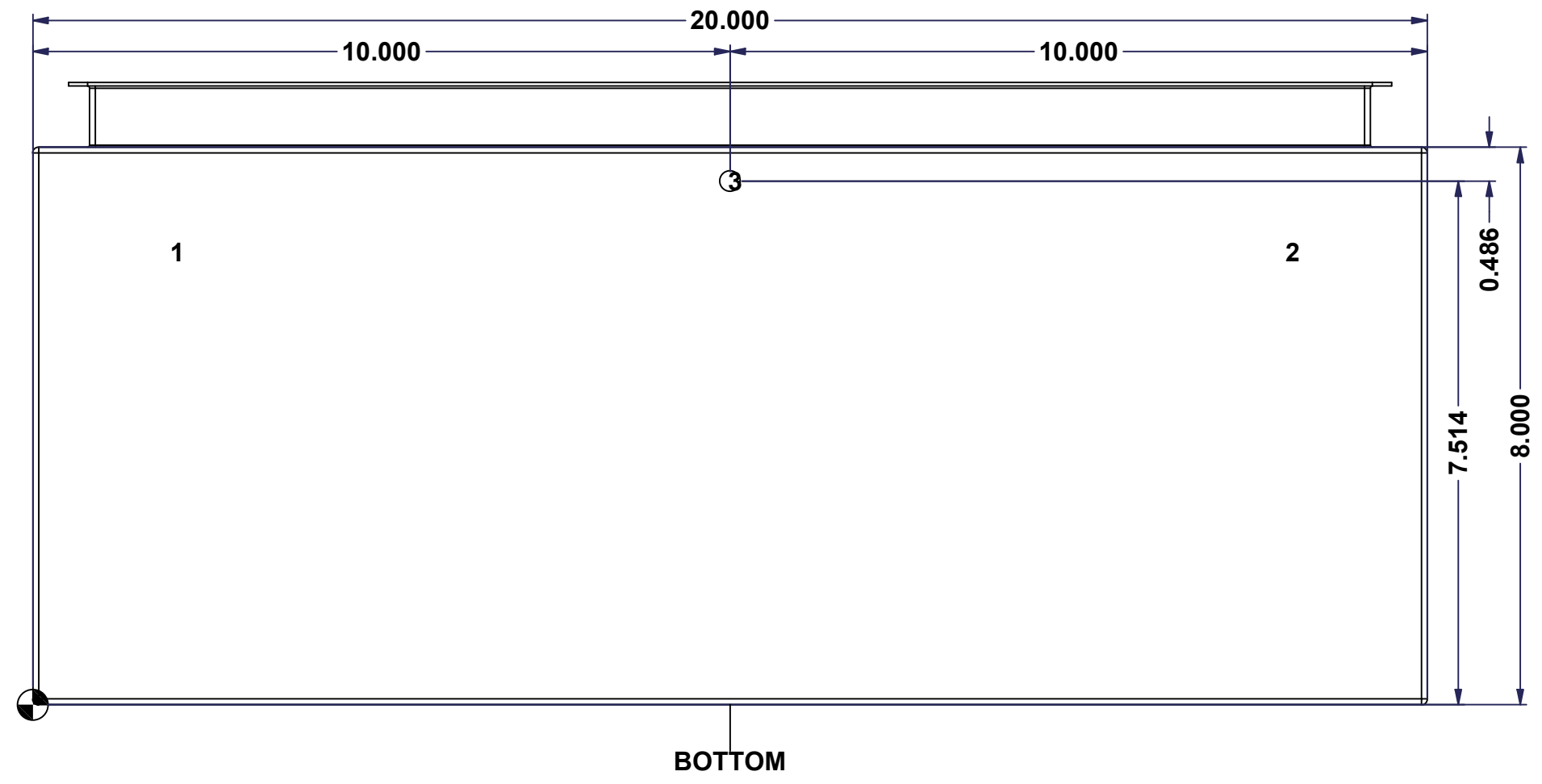

	Description	Status	
	5412ESFM 30" x 20" x 8" Body	(NULL)	
	Part Number Numéro Pièce	Rev.	
	5412ESFM302008THB	0	6
			19

This drawing is confidential and must not be reproduced or used without the consent of EXM

Ce dessin est confidentiel et ne doit pas être reproduit ou utilisé sans le consentement de EXM

STANDARD FEATURES ARE NOT LISTED IN THIS HOLE TABLE			
HOLE TABLE - LEFT VIEW (CUSTOM FEATURE ONLY)			
CUT-OUT	XDIM	YDIM	DESCRIPTION
1	7.514	24.000	RND Ø0.290
2	7.514	6.000	RND Ø0.290

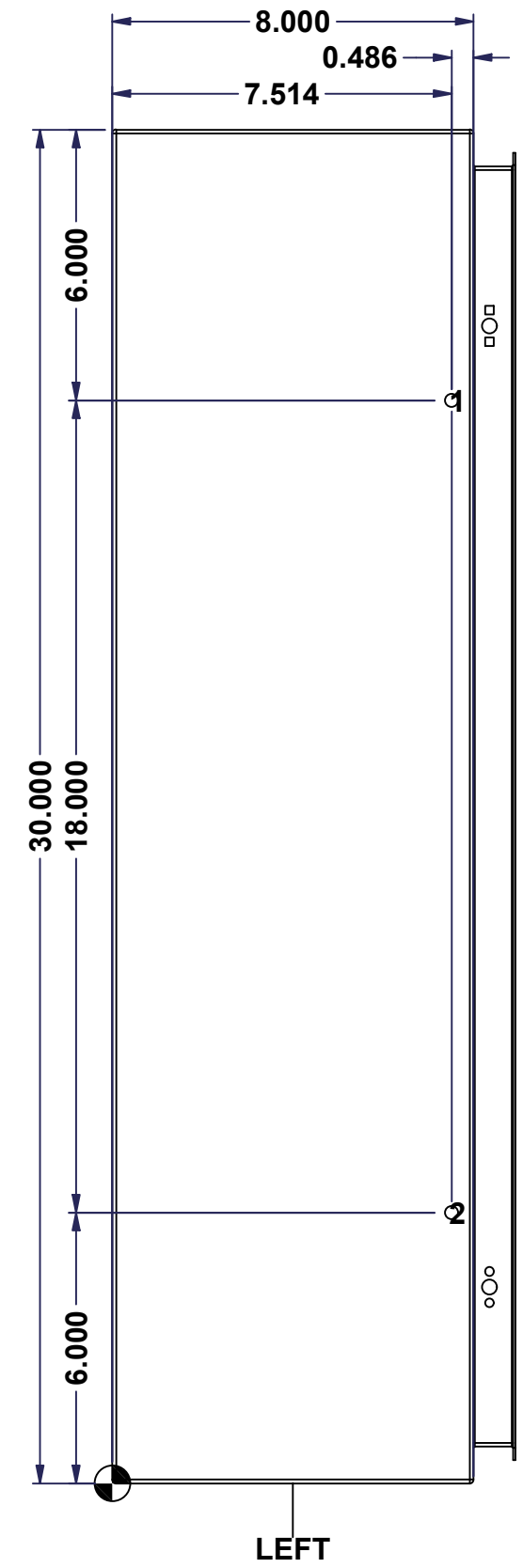

	Description	Status	
	5412ESFM 30" x 20" x 8" Body	(NULL)	
	Part Number Numéro Pièce	Rev.	7
	5412ESFM302008THB	0	19

This drawing is confidential and must not be reproduced or used without the consent of EXM

Ce dessin est confidentiel et ne doit pas être reproduit ou utilisé sans le consentement de EXM

STANDARD FEATURES ARE NOT LISTED IN THIS HOLE TABLE

HOLE TABLE - BACK VIEW (CUSTOM FEATURE ONLY)

CUT-OUT	XDIM	YDIM	DESCRIPTION
1	1.875	1.875	IP STUD M8 x 35mm (Inside)
2	1.875	28.125	IP STUD M8 x 35mm (Inside)
3	18.125	28.125	IP STUD M8 x 35mm (Inside)
4	18.125	1.875	IP STUD M8 x 35mm (Inside)

5	19.250	0.750	RND Ø0.390
6	19.250	29.250	RND Ø0.390
7	0.750	29.250	RND Ø0.390
8	0.750	0.750	RND Ø0.390

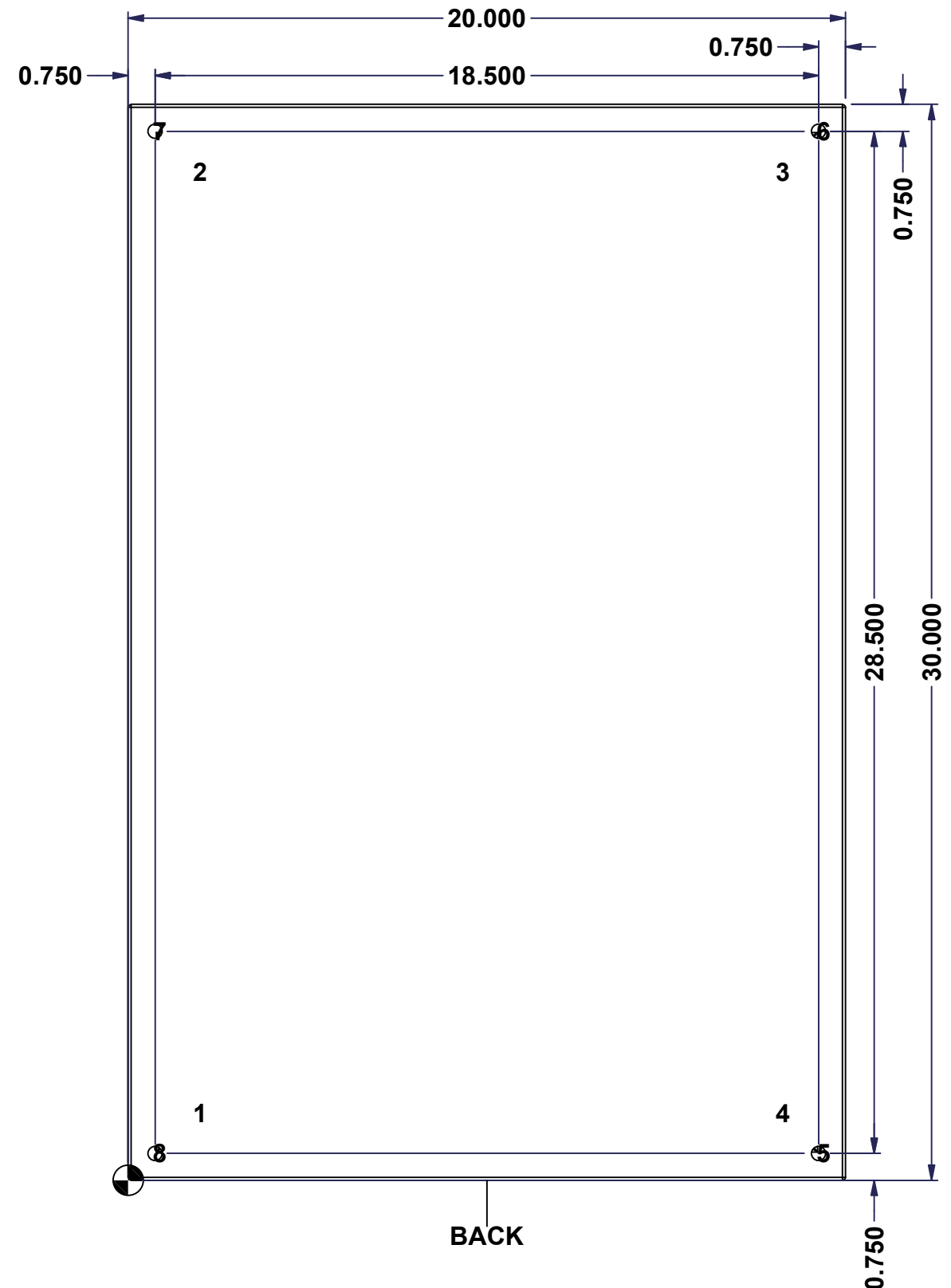

	Description	Status
	5412ESFM 30" x 20" x 8" Body	(NULL)
	Part Number	Rev.
	5412ESFM302008THB	8
		19

This drawing is confidential and must not be reproduced or used without the consent of EXM

Ce dessin est confidentiel et ne doit pas être reproduit ou utilisé sans le consentement de EXM

STANDARD FEATURES ARE NOT LISTED IN THIS HOLE TABLE

HOLE TABLE - FRONT VIEW (CUSTOM FEATURE ONLY)

CUT-OUT	XDIM	YDIM	DESCRIPTION
1	22.000	0.500	RND Ø0.290
2	0.500	0.500	RND Ø0.290
3	0.500	32.000	RND Ø0.290
4	22.000	32.000	RND Ø0.290

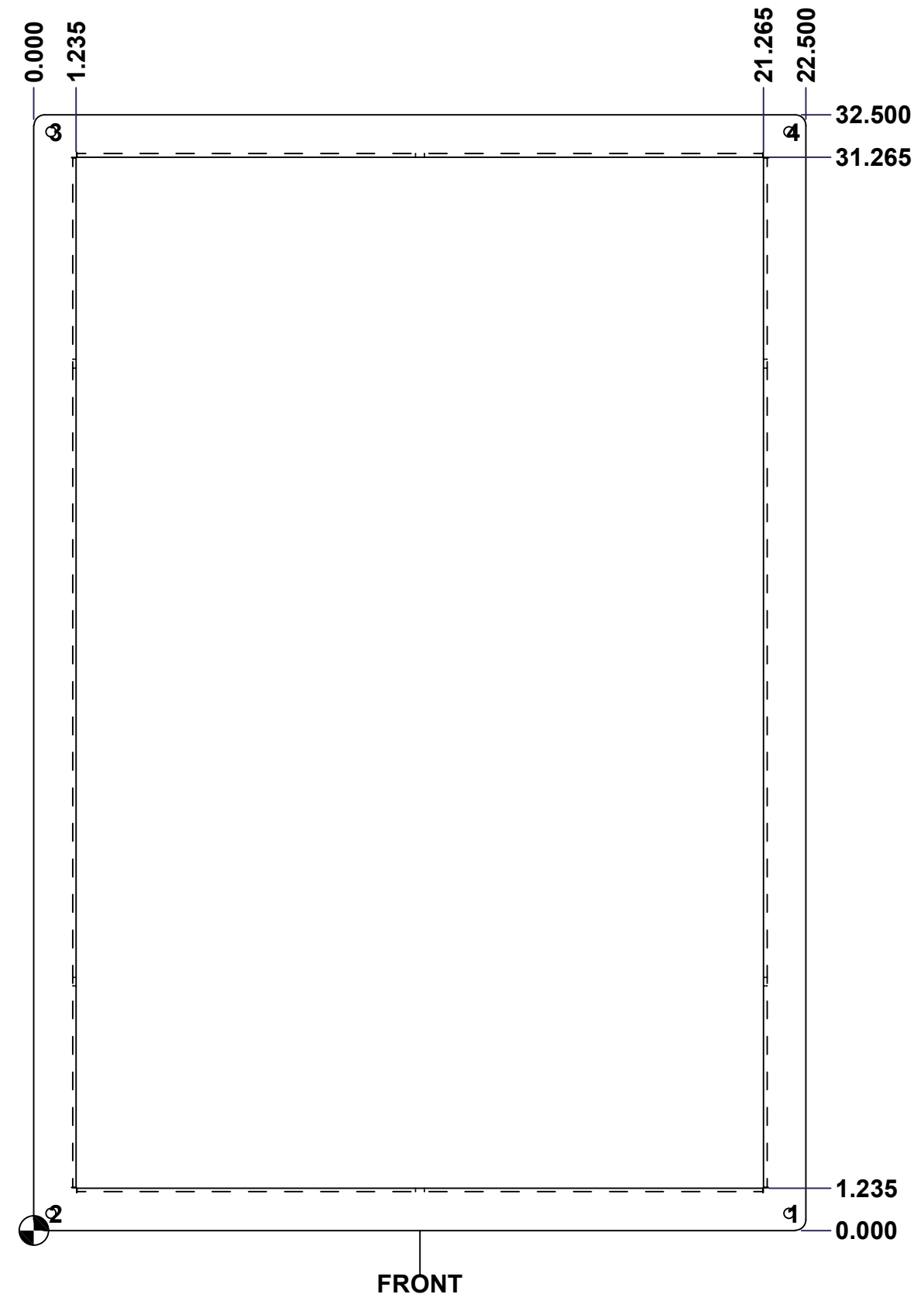

	Description	Status
	5412ESFM 30" x 20" x 8" Flange	(NULL)
Part Number Numéro Pièce	5412ESFM302008THB	Rev. 9
		0 19

This drawing is confidential and must not be reproduced or used without the consent of EXM

Ce dessin est confidentiel et ne doit pas être reproduit ou utilisé sans le consentement de EXM

No.	Revisions	Date	By/Par

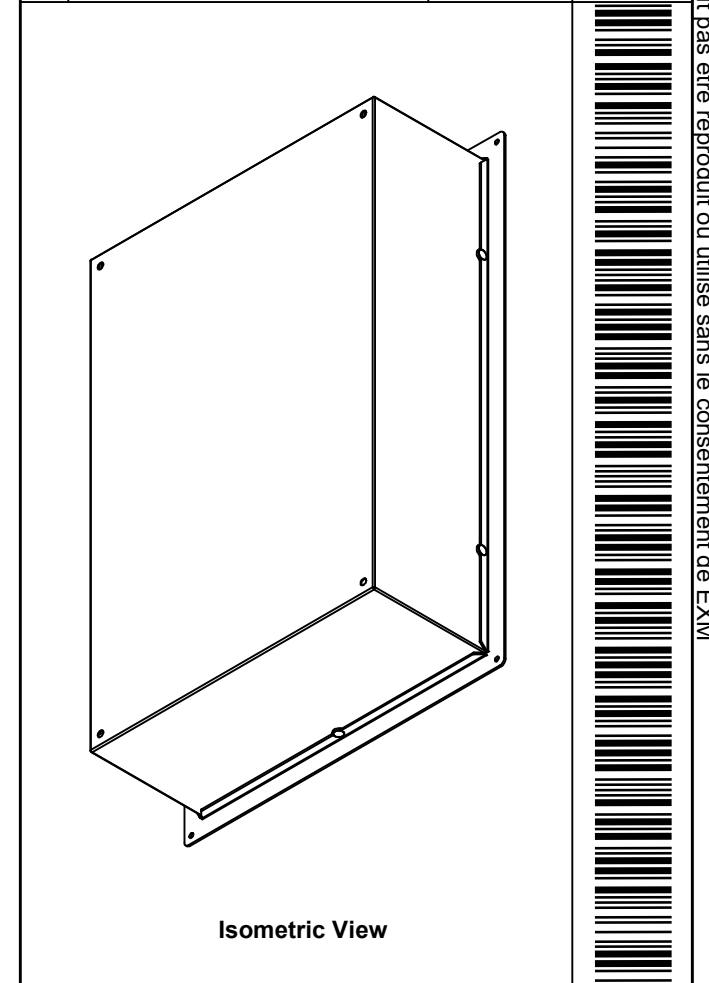

EXM
www.exmweb.com

Tél: (450) 979-4373
Fax: (450) 979-4626

Flatness
Aplatissement
Max 3.0mm

Projection

1	STK-K-70554	3	5412 ESTH Accessory Kit
1	5412ESFM302008THI-RS	0	5412ESFM 30" x 20" Right Insulation
1	5412ESFM302008THI-LS	0	5412ESFM 30" x 20" Left Insulation
1	5412ESFM302008THI-BT	0	5412ESFM 30" x 20"Bottom Insulation
1	5412ESFM302008THI-TP	0	5412ESFM 30" x 20"Top Insulation
1	5412ESFM302008THI-B	0	5412ESFM 30" x 20" Back Insulation
4	STK-Q-16055	1	M6 x 18mm Stud (No Paint Cap Required)
1	5412ESFM302008THF	0	5412ESFM 30" x 20" x 8" Flange
1	STK-P-02400S	0	Powder Paint (Asa-61 Grey / Smooth)
4	STK-Q-16005	0	Stud M8 x 35mm Steel
1	5412ESFM302008THB-P	0	5412ESFM 30" x 20" x 8" Body Part

Customer Client	Date
Drawn By / Dessiné Par: BoxCad: BoxCad	Date: 23-Dec-24
Material / Matière: 16 Ga Cold Rolled A1008 CS Type B (1.4mm)	
Color / Couleur: Asa-61 Grey	Finish / Fini: Smooth
Description: 5412ESFM 30" x 20" x 8" Body	Detail Rev.:
Part Number / Numéro Pièce: 5412ESFM302008THB	Rev. 0

Qty	Part Number	Rev	Description
Parts List			

This drawing is confidential and must not be reproduced or used without the consent of EXM

Ce dessin est confidentiel et ne doit pas être reproduit ou utilisé sans le consentement de EXM



TOP

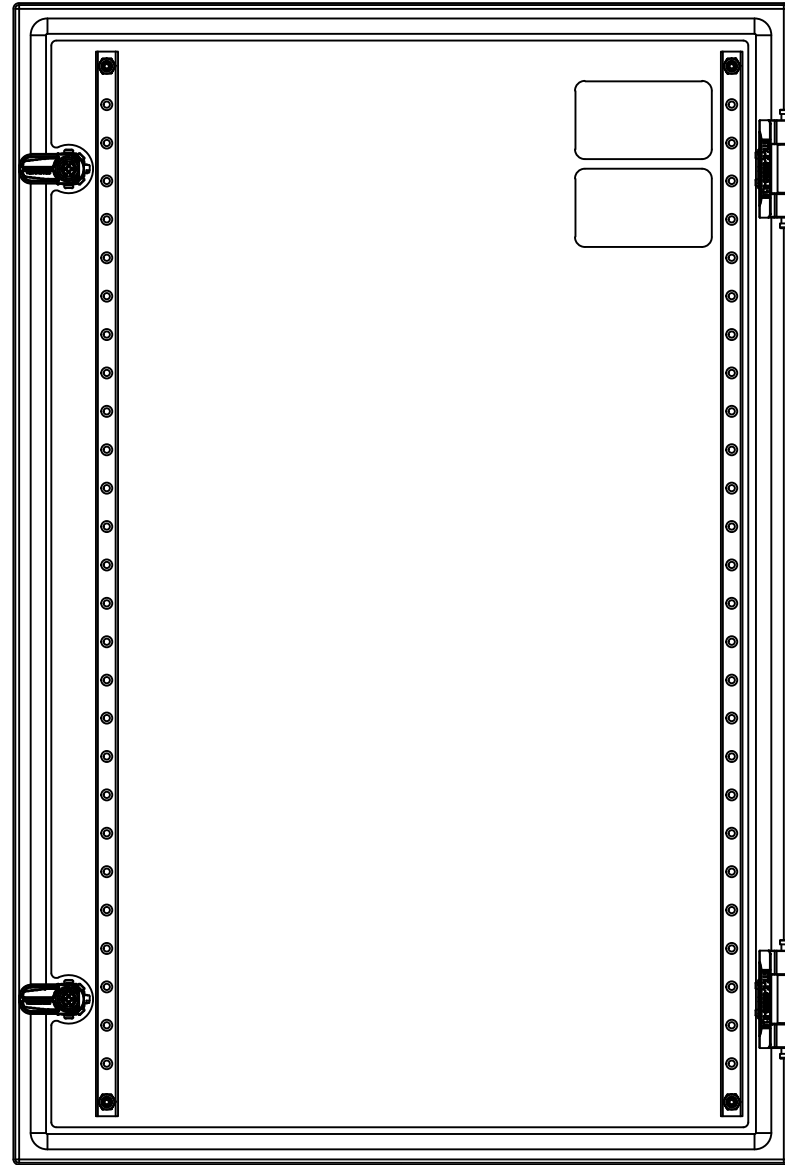

BACK

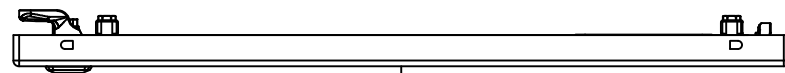

BOTTOM

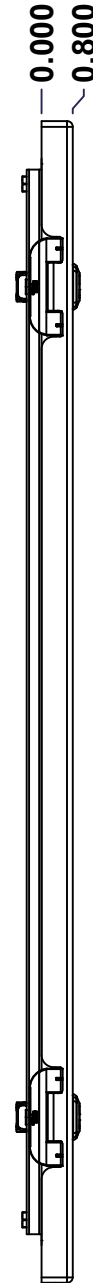

LEFT

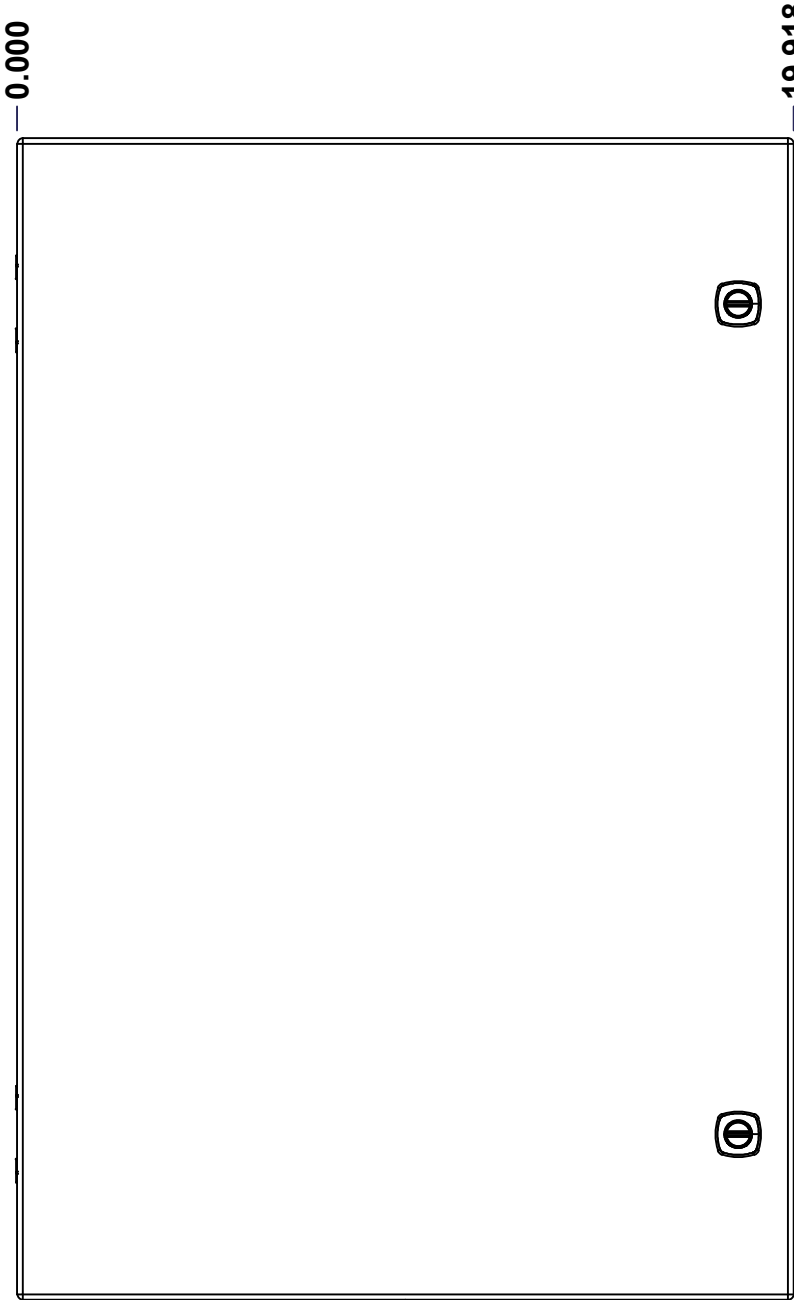

FRONT

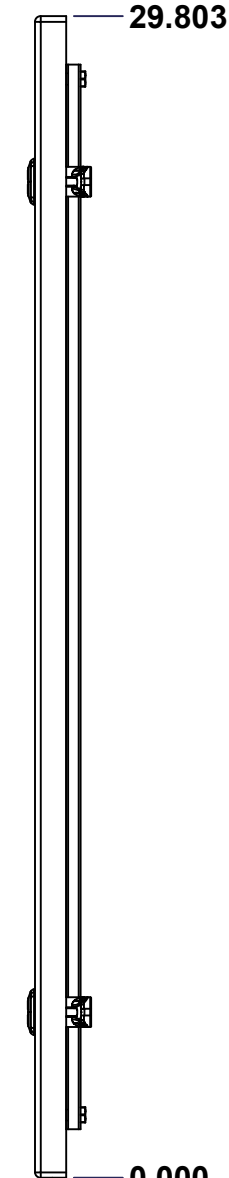

RIGHT

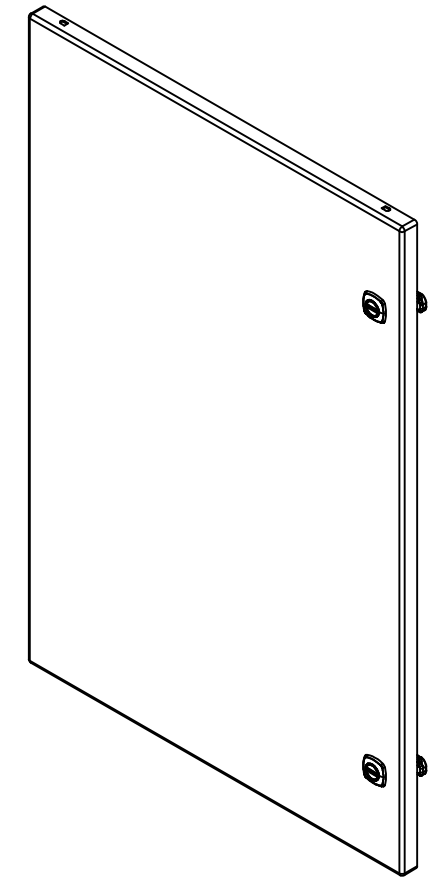

Isometric View

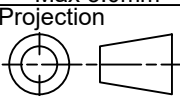

No.	Revisions	Date	By/Par

 Tél: (450) 979-4373 Fax: (450) 979-4626 www.exmweb.com		Flatness Aplatissement Max 3.0mm Projection 
Customer Client		Date
Drawn By Dessiné Par	BoxCad: BoxCad	Date 23-Dec-24
Material Matière	16 Ga Cold Rolled A1008 CS Type B (1.4mm)	
Color Couleur	Asa-61 Grey	Finish Fini Smooth
Description	5412ESFM 30" x 20" Cover	
Part Number Numéro Pièce	5412ESFM302008THC	Detail Rev. Rev. 11 0

SEE BILL OF MATERIAL ON LAST PAGE

This drawing is confidential and must not be reproduced or used without the consent of EXM

Ce dessin est confidentiel et ne doit pas être reproduit ou utilisé sans le consentement de EXM

STANDARD FEATURES ARE NOT LISTED IN THIS HOLE TABLE

HOLE TABLE - FRONT VIEW (CUSTOM FEATURE ONLY)

CUT-OUT	XDIM	YDIM	DESCRIPTION
1	1.486	1.614	STUD M6 x 18mm (Inside)
2	1.486	28.189	STUD M6 x 18mm (Inside)
3	17.517	28.189	STUD M6 x 18mm (Inside)
4	17.517	1.614	STUD M6 x 18mm (Inside)

5	18.494	25.553	LOCK 880 SCQ4-SL @ 0.0°
6	18.494	4.250	LOCK 880 SCQ4-SL @ 0.0°

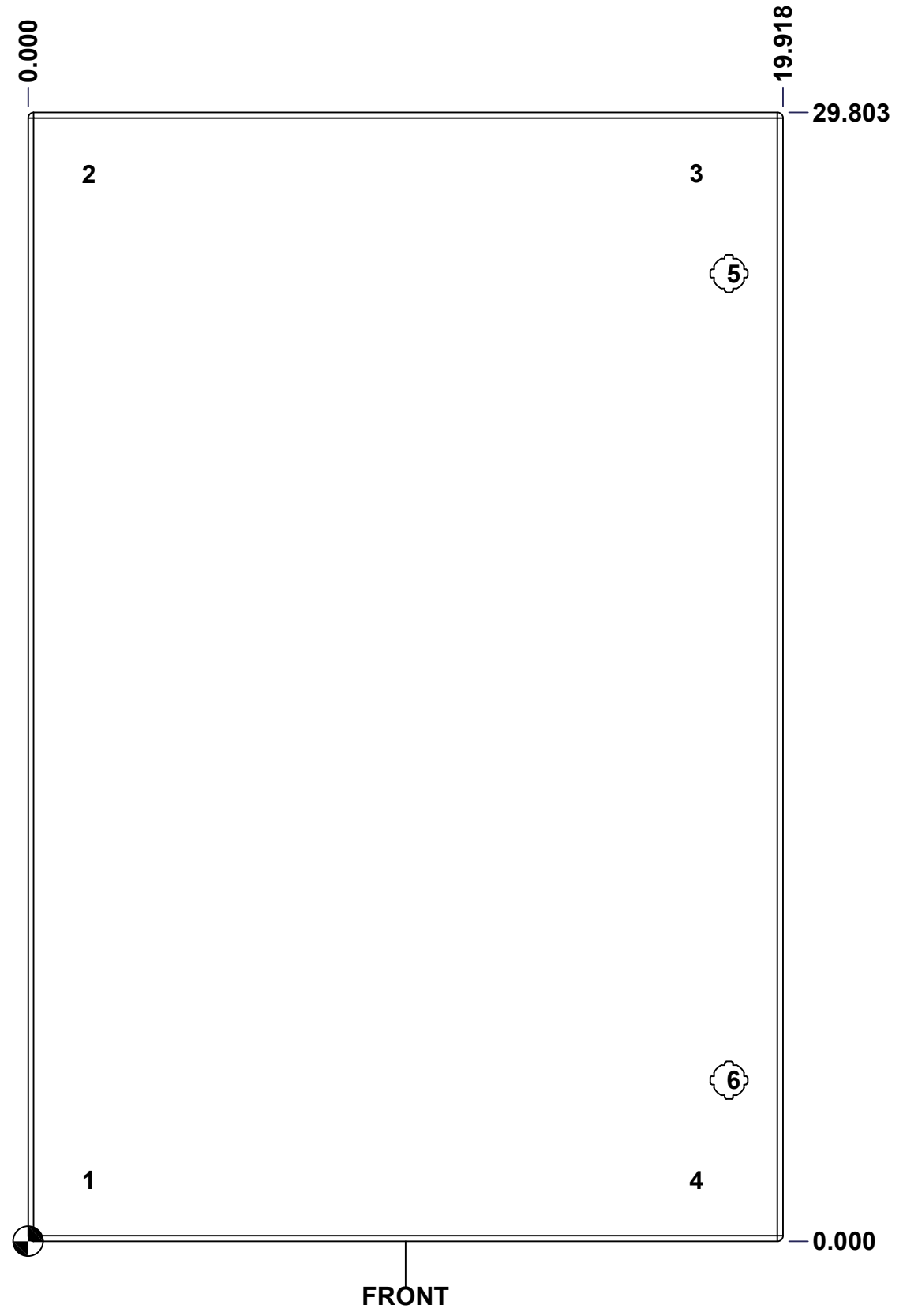

FRONT

	Description	Status
	5412ESFM 30" x 20" Cover	(NULL)
	Part Number Numéro Pièce	Rev.
	5412ESFM302008THC	0
		12
		19

This drawing is confidential and must not be reproduced or used without the consent of EXM

Ce dessin est confidentiel et ne doit pas être reproduit ou utilisé sans le consentement de EXM

No.	Revisions	Date	By/Par

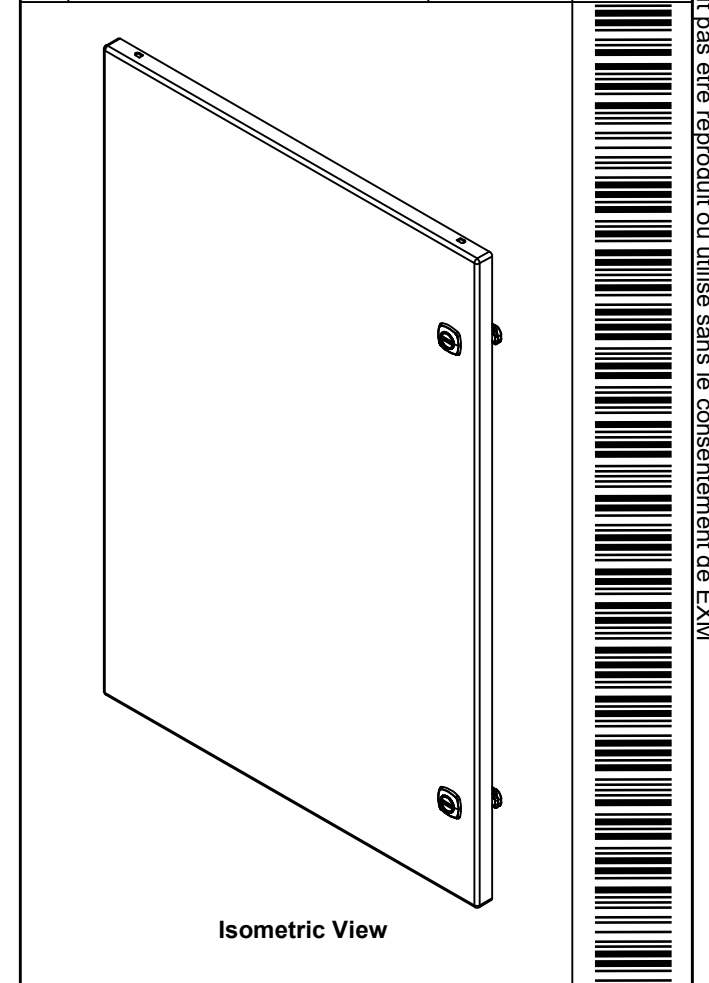

Isometric View

 Tél: (450) 979-4373
 Fax: (450) 979-4626
www.exmweb.com

Flatness / Aplatissement: Max 3.0mm
 Projection: 

2	STK-K-12500	19	5412 ES 1/4 Turn Lock
2	STK-S-00100	0	3.5" x 2" Silver Milar Flexcon Sticker
4	STK-Q-07250	2	M6 x 16mm Collar Nut
2	STK-Q-46020-30	6	5412 ES Vertical Door Stiffener 30"
1	5412ESFM302008THI-C	0	5412ESFM 30" x 20" Cover Insulation
1	STK-P-02400S	0	Powder Paint (Asa-61 Grey / Smooth)
4	STK-Q-16055	1	M6 x 18mm Stud (No Paint Cap Required)
1	5412ESFM302008THG	0	5412ESFM 30" x 20" Cover Gasket Part
1	5412ESFM302008THC-P	0	5412ESFM 30" x 20" Cover Part
2	STK-K-09800	10	5412 ES Hinge with 2 Captive Hinge Pins

Customer / Client	Date
Drawn By / Dessiné Par: BoxCad: BoxCad	Date: 23-Dec-24
Material / Matière: 16 Ga Cold Rolled A1008 CS Type B (1.4mm)	

Color / Couleur: Asa-61 Grey	Finish / Fini: Smooth
Description: 5412ESFM 30" x 20" Cover	Detail Rev.

QTY	Part Number	Rev	Description
Parts List			

Part Number / Numéro Pièce: 5412ESFM302008THC	Rev. / Révis: 0	13 / 19
--	------------------------	---------

This drawing is confidential and must not be reproduced or used without the consent of EXM

Ce dessin est confidentiel et ne doit pas être reproduit ou utilisé sans le consentement de EXM

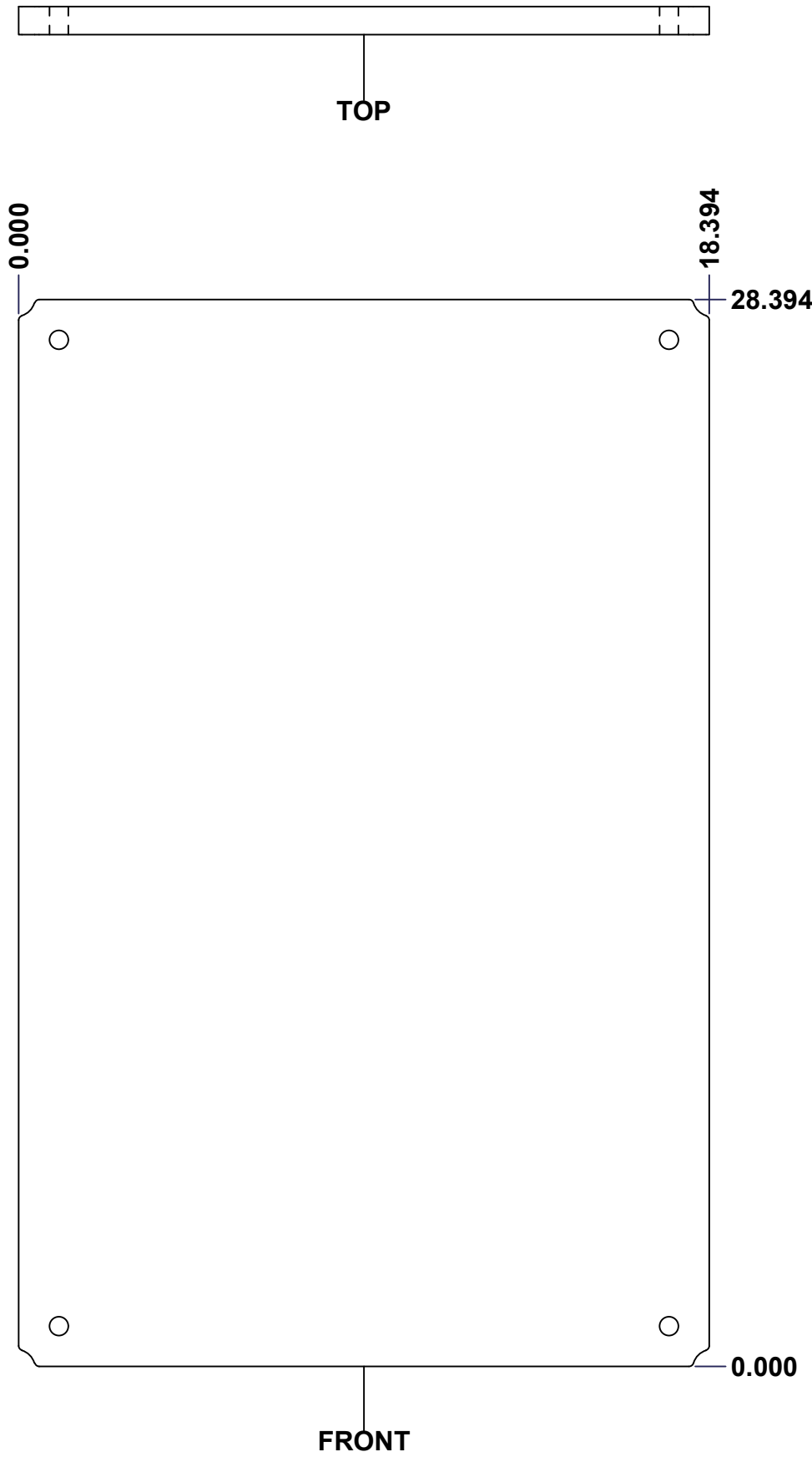

No.	Revisions	Date	By/Par

Isometric View

<p>Tél: (450) 979-4373 Fax: (450) 979-4626 www.exmweb.com</p>		Flatness Aplatissement
		Max 3.0mm
Projection		
Customer Client	Date	
Drawn By Dessiné Par	BoxCad: Patrick Deschenes	Date 23-Jan-07
Material Matière Polyisocyanurate		
Color Couleur	Aluminum	Finish Fini N/A
Description		Detail Rev.
5412ESFM 30" x 20" Back Insulation		
Part Number Numéro Pièce	Rev.	14
5412ESFM302008THI-B	0	19

SEE BILL OF MATERIAL ON LAST PAGE

This drawing is confidential and must not be reproduced or used without the consent of EXM

Ce dessin est confidentiel et ne doit pas être reproduit ou utilisé sans le consentement de EXM

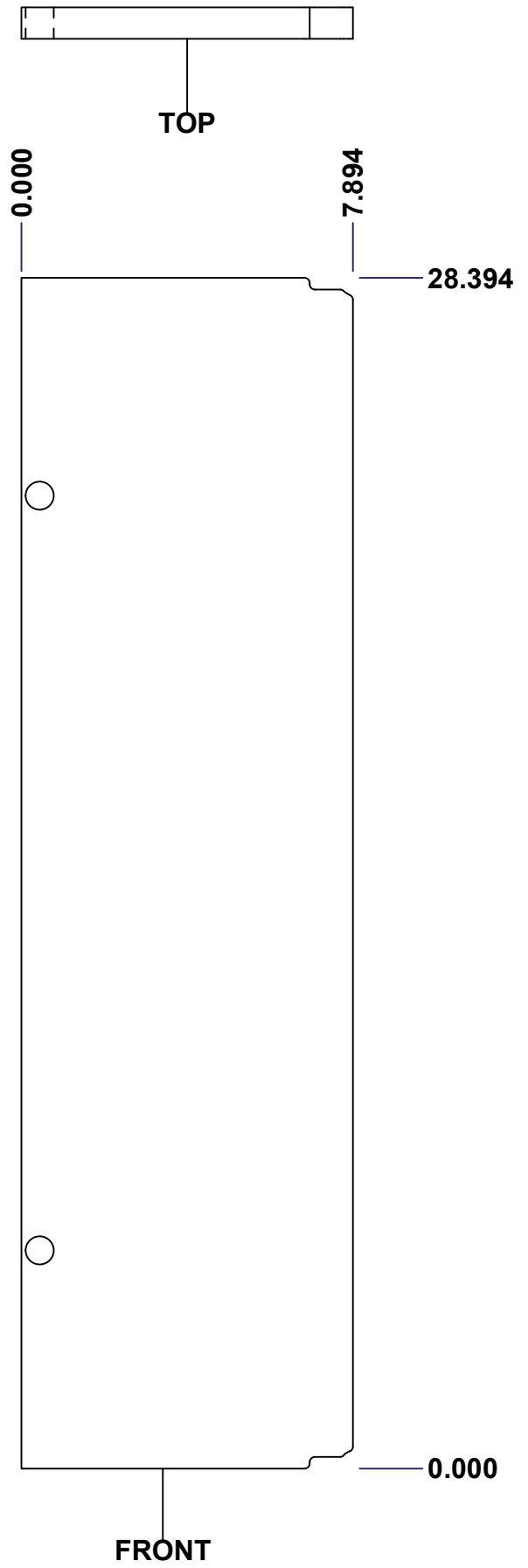

SEE BILL OF MATERIAL ON LAST PAGE

No.	Revisions	Date	By/Par

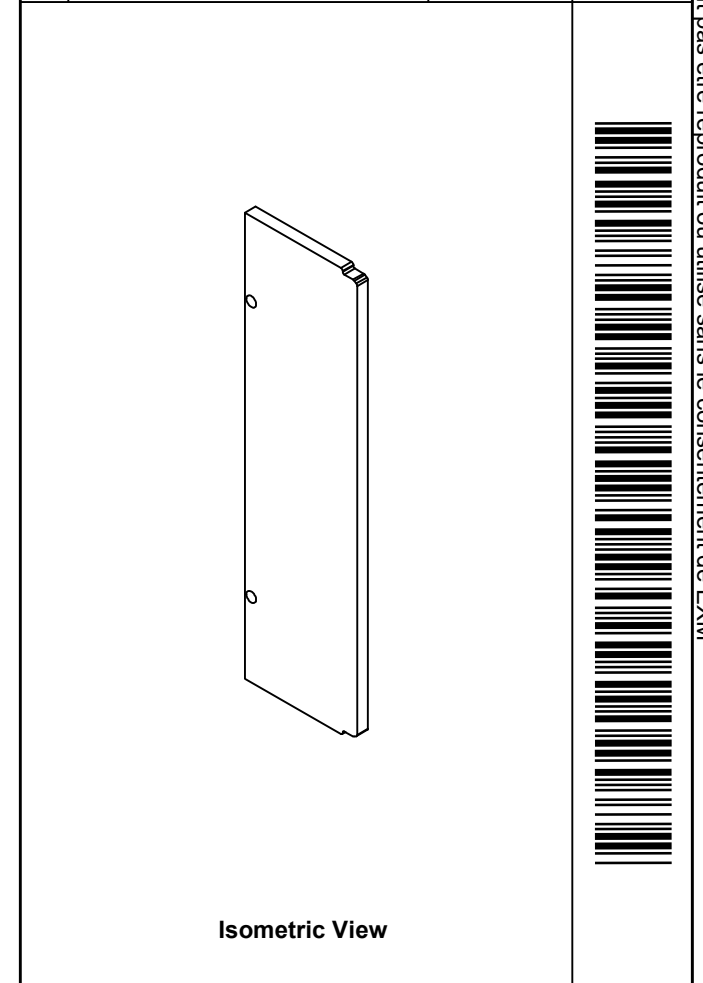

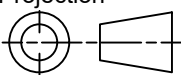
 Tél: (450) 979-4373 Fax: (450) 979-4626 www.exmweb.com		Flatness Aplatissement Max 3.0mm
Customer Client		Projection 
Drawn By / Dessiné Par: BoxCad: Patrick Deschenes		Date: 23-Jan-07
Material / Matière: Polyisocyanurate		
Color / Couleur: Aluminum	Finish / Fini: N/A	
Description: 5412ESFM 30" x 20" Left Insulation		Detail Rev.
Part Number / Numéro Pièce: 5412ESFM302008THI-LS		Rev. 0
15		19

This drawing is confidential and must not be reproduced or used without the consent of EXM

Ce dessin est confidentiel et ne doit pas être reproduit ou utilisé sans le consentement de EXM

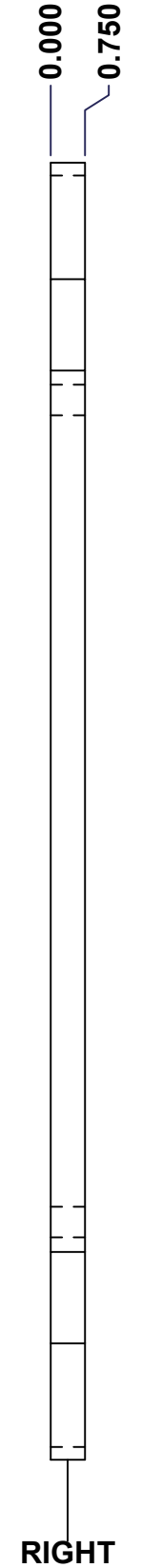
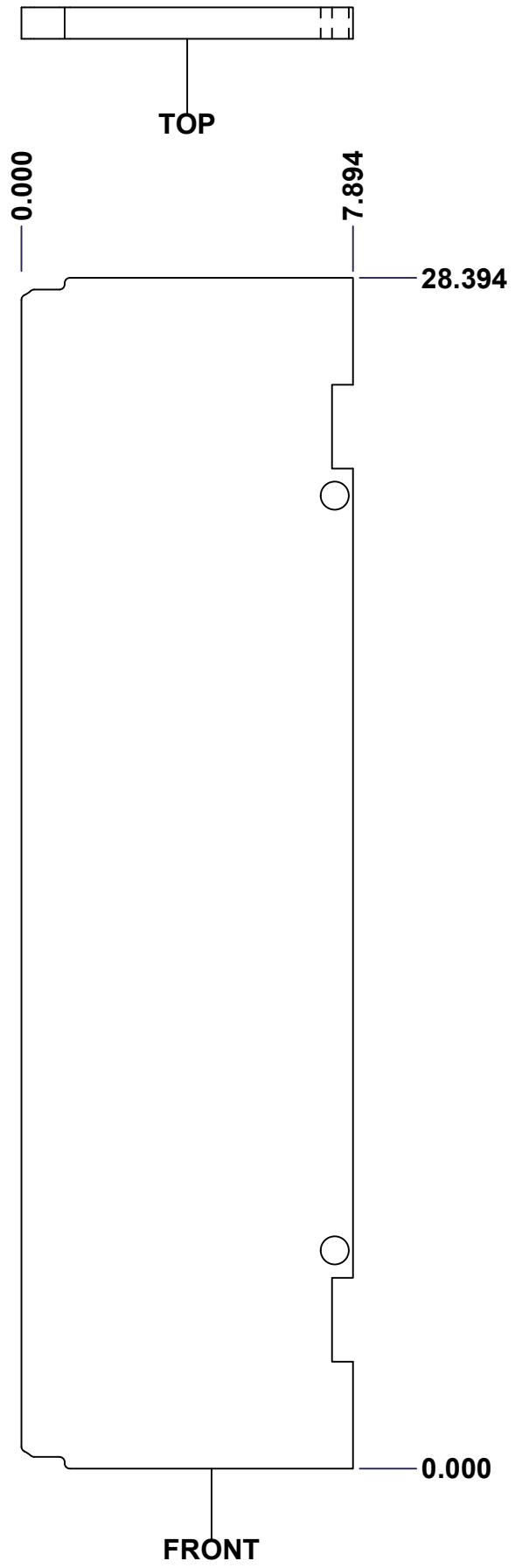

No.	Revisions	Date	By/Par

Isometric View

Tél: (450) 979-4373 Fax: (450) 979-4626 www.exmweb.com		Flatness Aplatissement	
		Max 3.0mm	
Customer Client		Date	
Drawn By Dessiné Par		Date 23-Jan-07	
Material Matière		Polyisocyanurate	
Color Couleur	Aluminum	Finish Fini	N/A
Description			Detail Rev.
5412ESFM 30" x 20" Right Insulation			
Part Number Numéro Pièce		Rev.	16
5412ESFM302008THI-RS		0	19

SEE BILL OF MATERIAL ON LAST PAGE

This drawing is confidential and must not be reproduced or used without the consent of EXM

Ce dessin est confidentiel et ne doit pas être reproduit ou utilisé sans le consentement de EXM

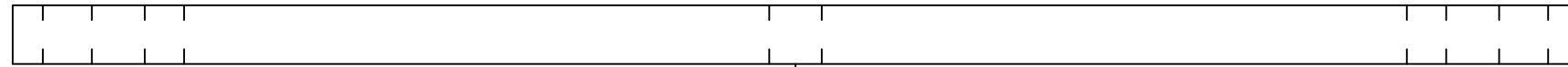

TOP

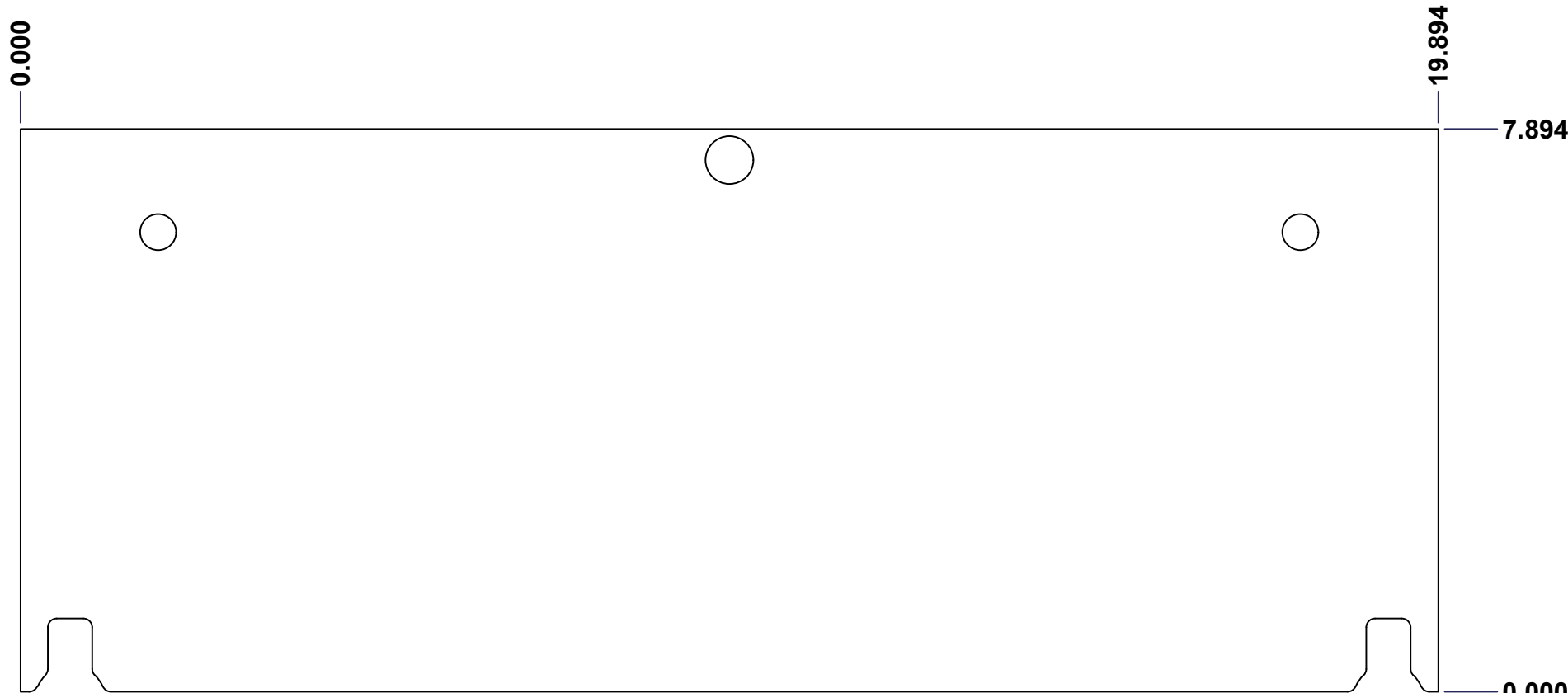

FRONT

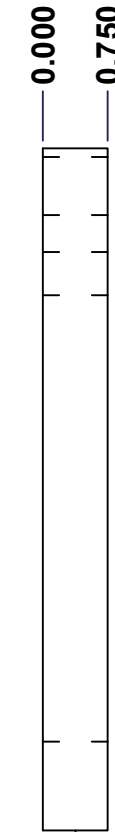

RIGHT

No.	Revisions	Date	By/Par

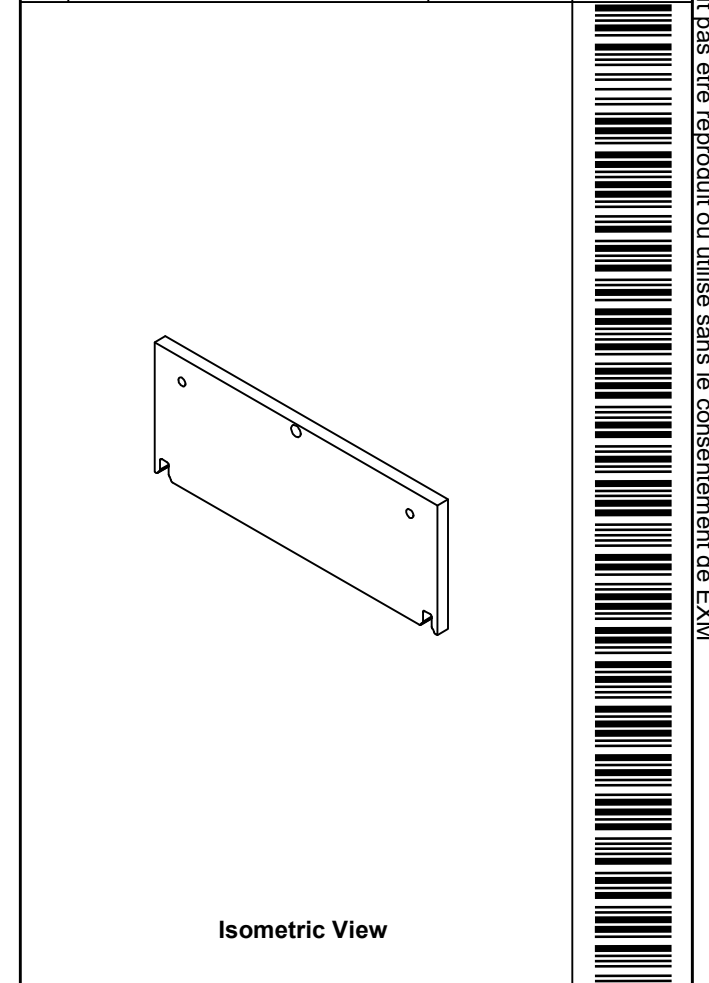

Isometric View

 Tél: (450) 979-4373
 Fax: (450) 979-4626
www.exmweb.com

Flatness / Aplatissement: Max 3.0mm
 Projection: 

Customer Client	Date
Drawn By / Dessiné Par: BoxCad: BoxCad	Date: 4/3/2024
Material / Matière: Polyisocyanurate	
Color / Couleur: Aluminum	Finish / Fini: Smooth
Description: 5412ESFM 30" x 20"Top Insulation	Detail Rev.
Part Number / Numéro Pièce: 5412ESFM302008THI-TP	Rev. 0

SEE BILL OF MATERIAL ON LAST PAGE

This drawing is confidential and must not be reproduced or used without the consent of EXM

Ce dessin est confidentiel et ne doit pas être reproduit ou utilisé sans le consentement de EXM

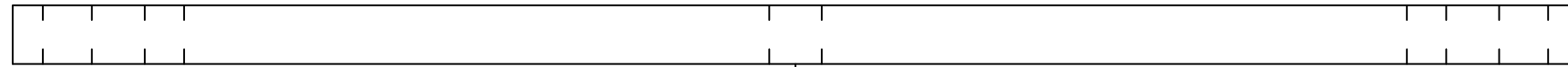

TOP

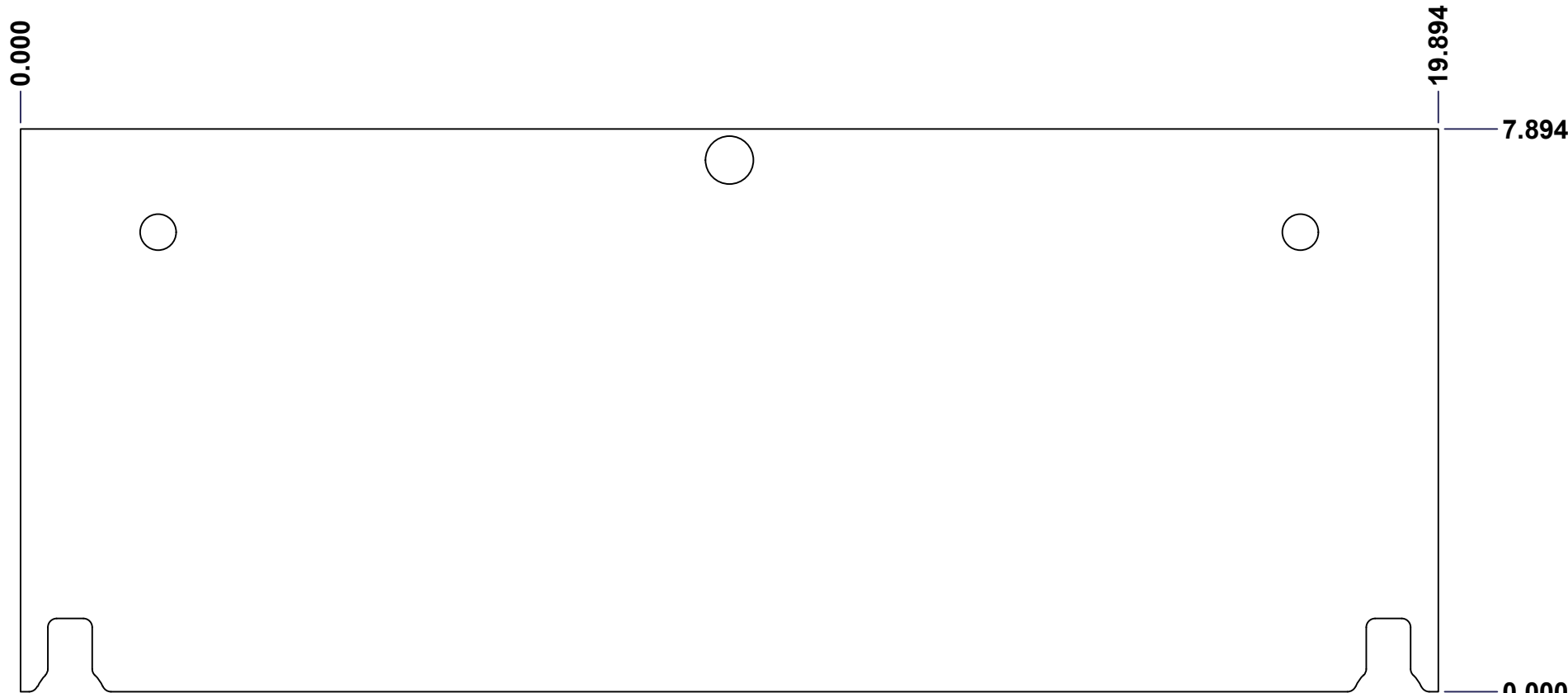

FRONT

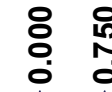

RIGHT

No.	Revisions	Date	By/Par

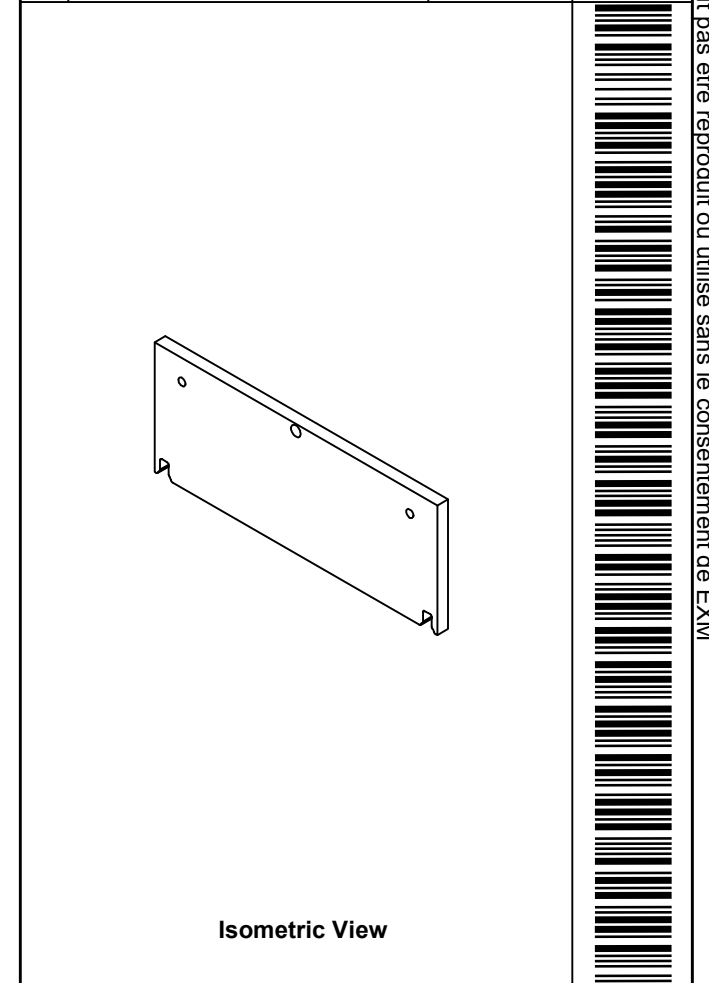

Isometric View

 Tél: (450) 979-4373
 Fax: (450) 979-4626
www.exmweb.com

Flatness / Aplatissement: Max 3.0mm
 Projection: 

Customer Client	Date
Drawn By / Dessiné Par: BoxCad: BoxCad	Date: 4/3/2024
Material / Matière: Polyisocyanurate	
Color / Couleur: Aluminum	Finish / Fini: Smooth
Description: 5412ESFM 30" x 20" Bottom Insulation	Detail Rev.
Part Number / Numéro Pièce: 5412ESFM302008THI-BT	Rev. 0

SEE BILL OF MATERIAL ON LAST PAGE

This drawing is confidential and must not be reproduced or used without the consent of EXM

Ce dessin est confidentiel et ne doit pas être reproduit ou utilisé sans le consentement de EXM

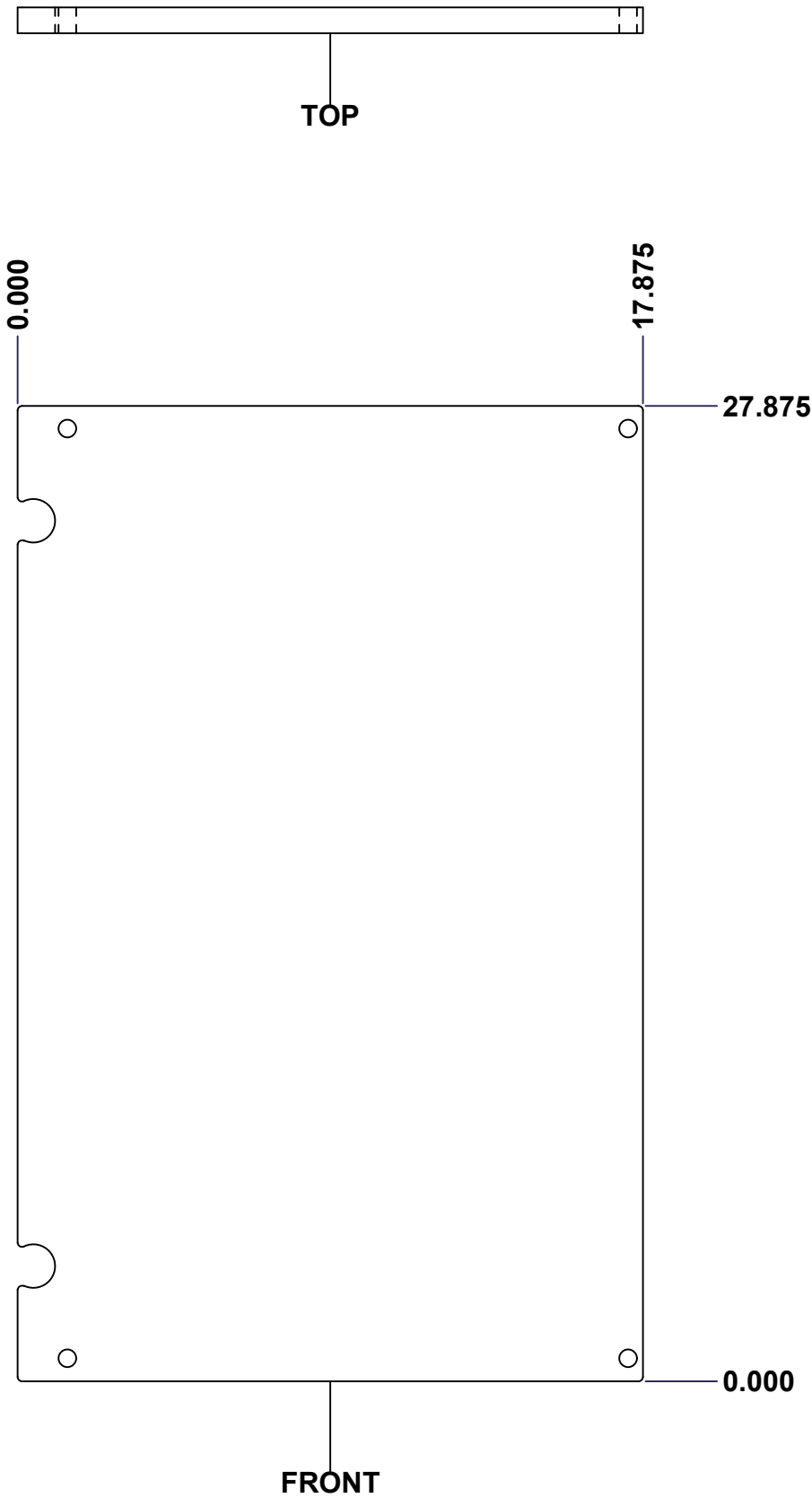

No.	Revisions	Date	By/Par

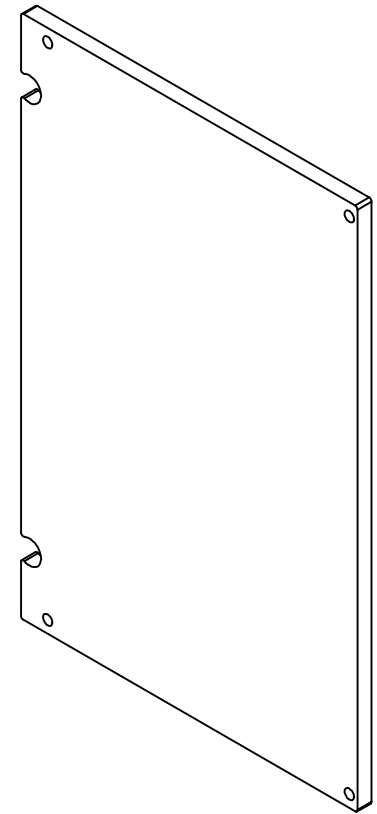

Isometric View



Tél: (450) 979-4373
 Fax: (450) 979-4626
www.exmweb.com

Flatness
 Aplatissement
 Max 3.0mm
 Projection

Customer Client	Date
Drawn By Dessiné Par	Date 23-Jan-07
Material Matière	Polyisocyanurate
Color Couleur	Aluminum
Finish Fini	N/A
Description	Detail Rev.
5412ESFM 30" x 20" Cover Insulation	
Part Number Numéro Pièce	Rev.
5412ESFM302008TH-C	0
	19
	19

SEE BILL OF MATERIAL ON LAST PAGE

This drawing is confidential and must not be reproduced or used without the consent of EXM

Ce dessin est confidentiel et ne doit pas être reproduit ou utilisé sans le consentement de EXM

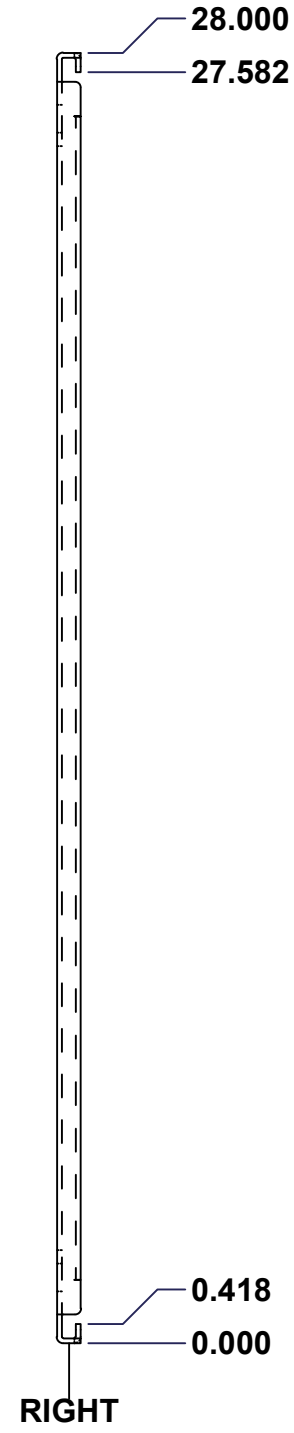
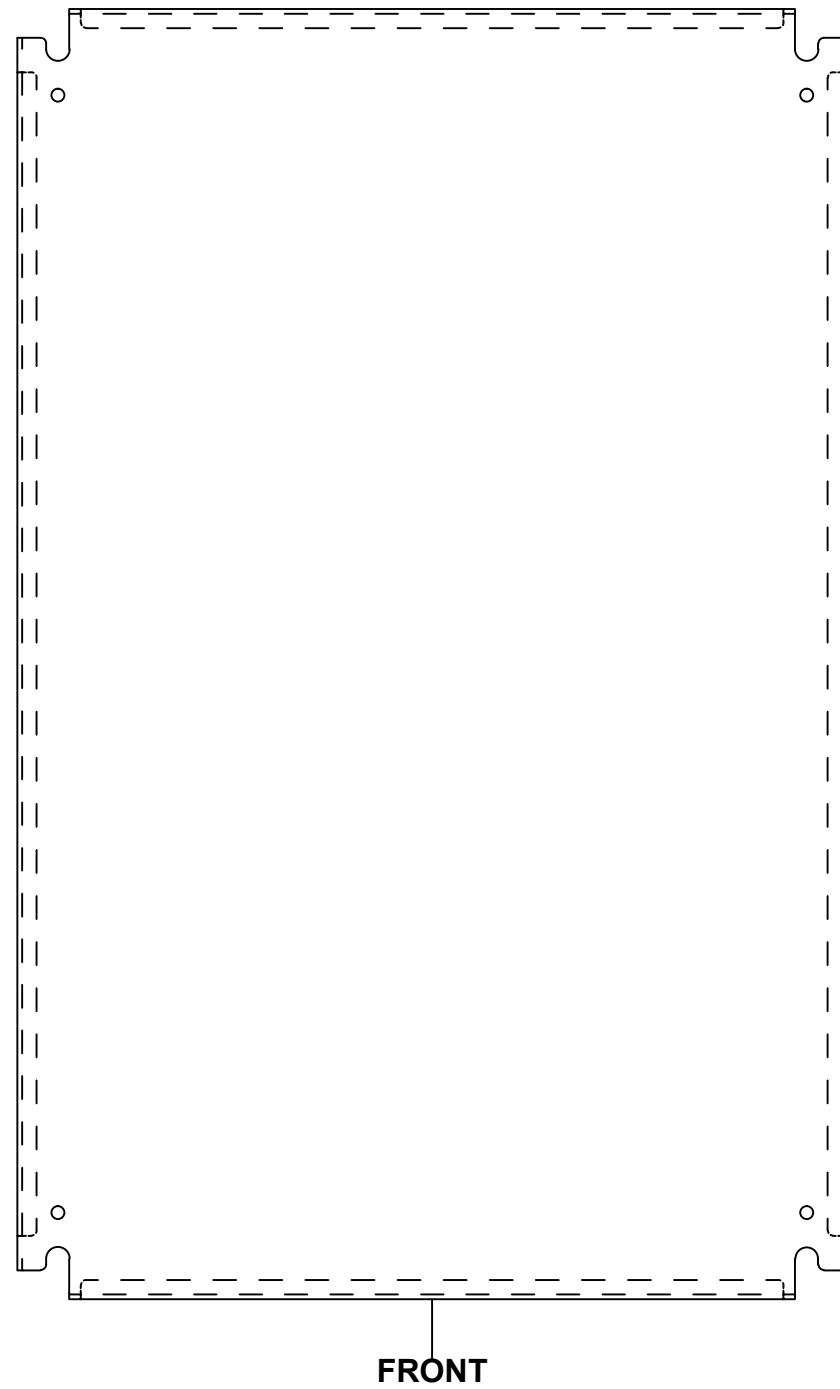
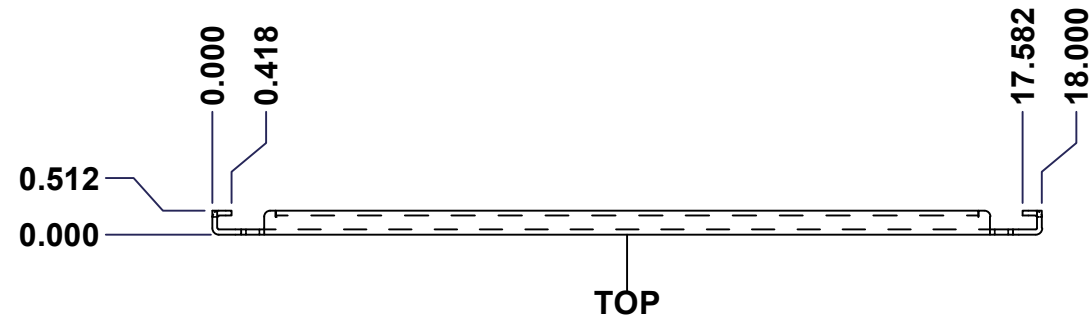

No.	Revisions	Date	By/Par

Isometric View

Tél: (450) 979-4373 Fax: (450) 979-4626 www.exmweb.com	Flatness Aplatissement
	Max 3.0mm
Projection	
Customer Client	Date
Drawn By Dessiné Par BoxCad	Date 23-Jan-07
Material Matière	See Part List
Color Couleur	See Part List
Finish Fini	See Part List
Description	Detail Rev.
881 SP - Inner Panel	
Part Number Numéro Pièce	Rev. 1
881 SP3020G	0 2

Qty	Part Number	Rev	Description	Material	Color	Finish
1	881 SP3020G-P	0	881 SP - Inner Panel Part	12 Ga Galvanized	Unpainted	Galvanized

Parts List

This drawing is confidential and must not be reproduced or used without the consent of EXM

Ce dessin est confidentiel et ne doit pas être reproduit ou utilisé sans le consentement de EXM

Table 1			FRONT VIEW
CUT-OUT	XDIM	YDIM	DESCRIPTION
1	0.875	1.875	GROUND HOLE (RND Ø0.290)
2	17.125	1.875	GROUND HOLE (RND Ø0.290)
3	0.875	26.125	GROUND HOLE (RND Ø0.290)
4	17.125	26.125	GROUND HOLE (RND Ø0.290)

All knockouts are actual size / Les disques défonçables sont grandeur réel

No.	Revisions	Date	By/Par

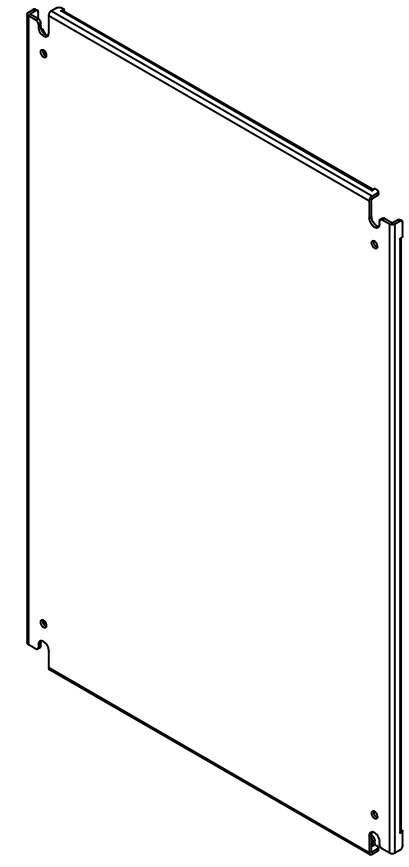
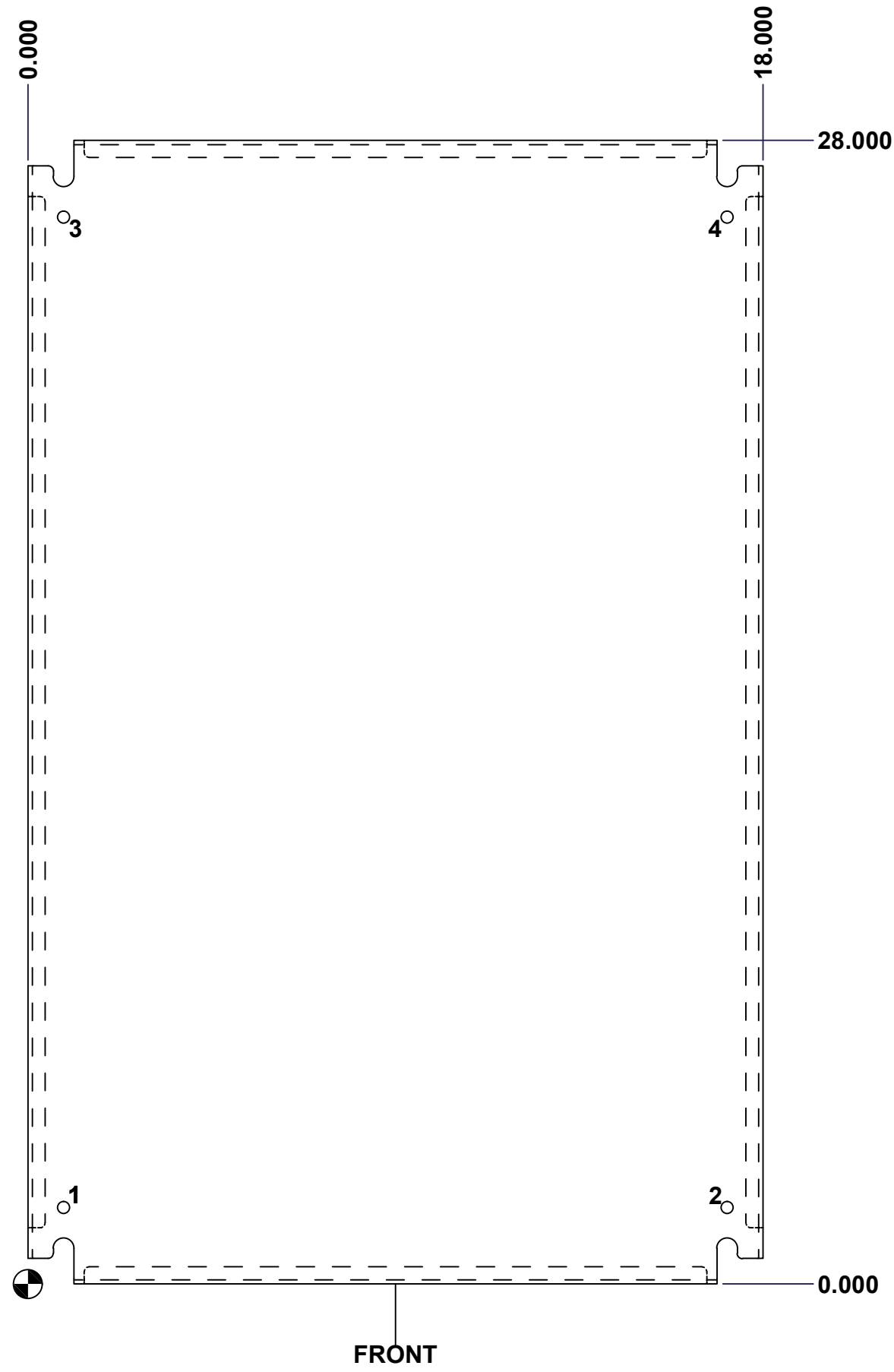

Isometric View



	Tél: (450) 979-4373 Fax: (450) 979-4626 www.exmweb.com	Flatness Aplatissement Max 3.0mm
		Projection
Customer Client		Date
Drawn By Dessiné Par	BoxCad	Date 23-Jan-07
Material Matière	See Part List	
Color Couleur	See Part List	Finish Fini See Part List
Description	881 SP - Inner Panel	
Part Number Numéro Pièce	881 SP3020G	Detail Rev. Rev. 2 0