

This drawing is confidential and must not be reproduced or used without the consent of EXM

Ce dessin est confidentiel et ne doit pas être reproduit ou utilisé sans le consentement de EXM

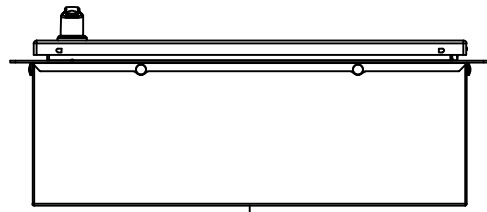

TOP

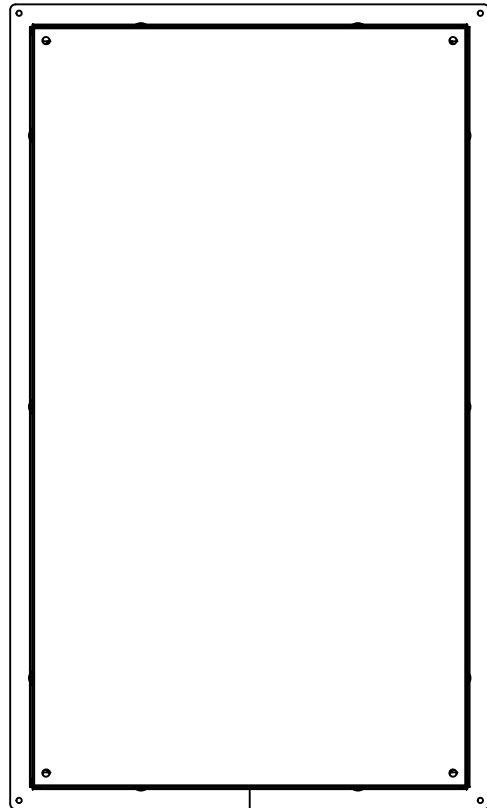

BACK

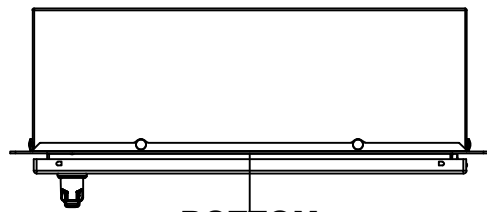

BOTTOM

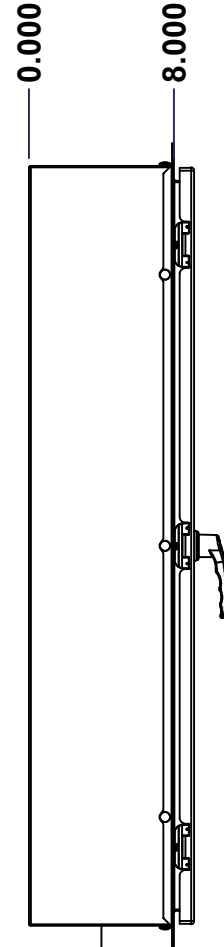

LEFT

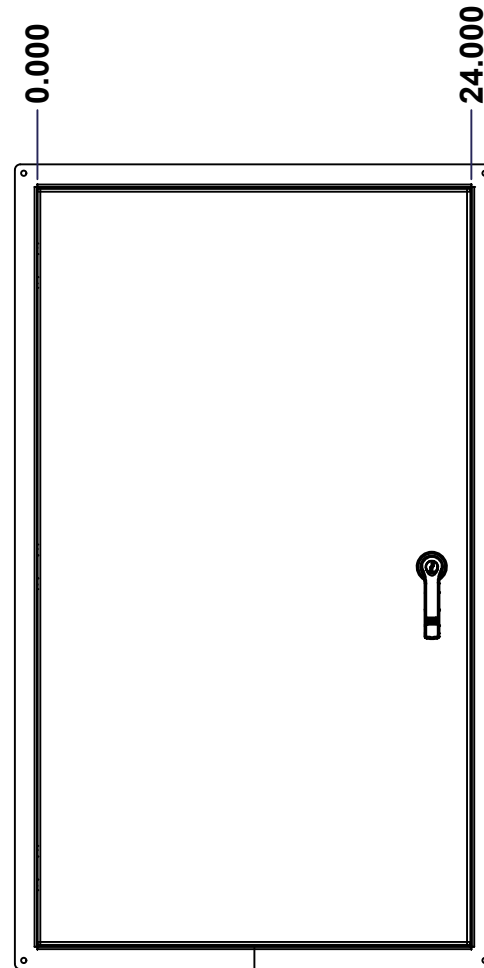

FRONT

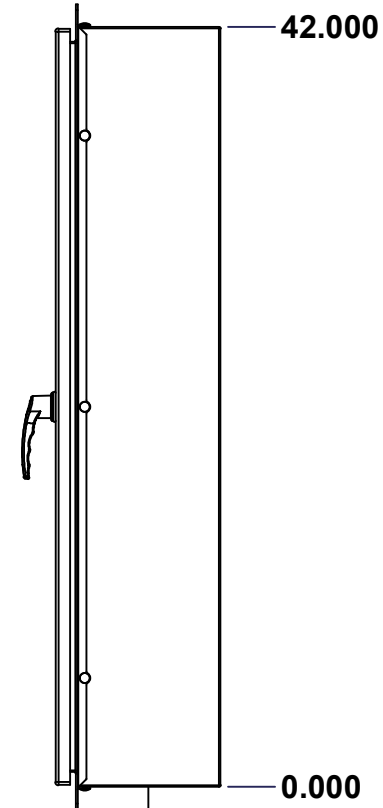

RIGHT

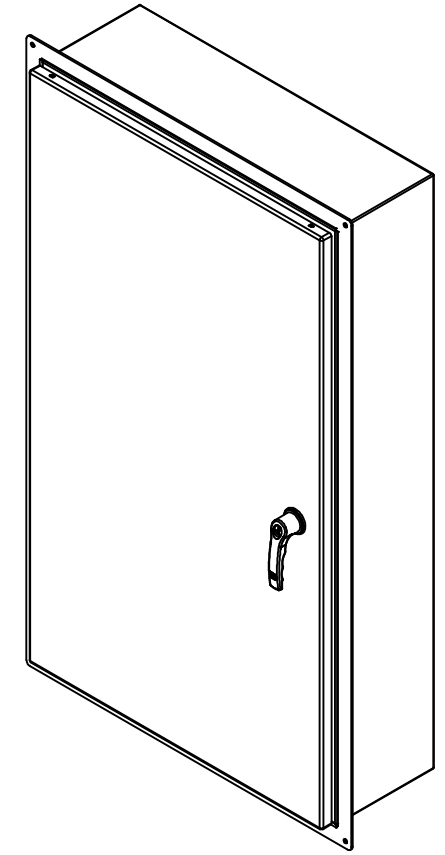

Isometric View

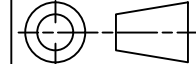

No.	Revisions	Date	By/Par

 Tél: (450) 979-4373 Fax: (450) 979-4626 www.exmweb.com		Flatness Aplatissement Max 3.0mm Projection 
Customer Client	Date	
Drawn By Dessiné Par	BoxCad: BoxCad	Date 24-Dec-24
Material Matière	16 Ga Cold Rolled A1008 CS Type B (1.4mm)	
Color Couleur	Asa-61 Grey	Finish Fini Smooth
Description	Detail Rev.	
5412ESFM 42" x 24" x 8" Assembly		
Part Number Numéro Pièce	Rev. 0	1 19

SEE BILL OF MATERIAL ON LAST PAGE

5412ESFM422408TH

This drawing is confidential and must not be reproduced or used without the consent of EXM

Ce dessin est confidentiel et ne doit pas être reproduit ou utilisé sans le consentement de EXM

NOTE	
ITEM	DESCRIPTION
1	NEMA 4, 12 Enclosure (IP66)
2	C/W Standard ground studs on box and cover
3	C/W Standard door stiffener
4	C/W Standard inner panel (Included)
5	C/W Standard inner panel mounting studs
6	C/W R5 Insulation (Installed aluminum visible)

No.	Revisions	Date	By/Par

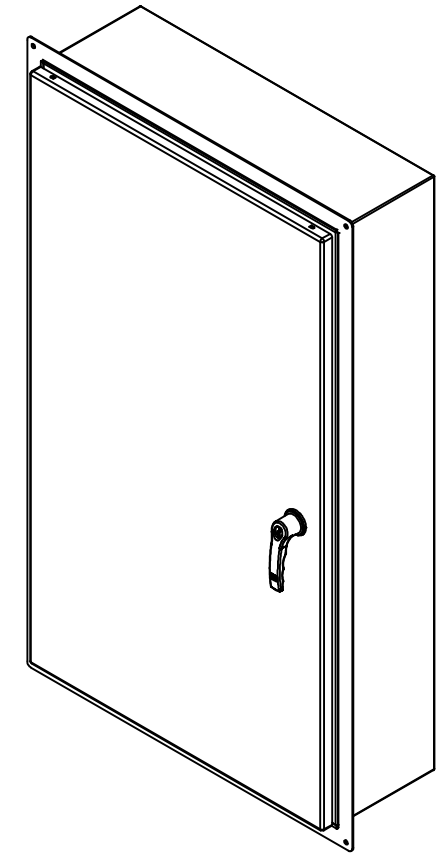

Isometric View



PACKING		
ITEM	QTY	DESCRIPTION
Cardboard sleeve	2	Top and Bottom
Cardboard strip	2	Between back of enclosure and inner panel
Plastic bag	1	To protect cover surface and inside gasket
Cardboard corner	4	To reinforced for the plastic strap tightening
Plastic strap - Black	2	To Squeeze the 2 cardboard sleeve together
Packaging label	3	White label with PN
Plastic strap- Green	2	To secure the enclosure to the wood pallet
Wood Pallet	1	2" deeper and 3" larger than enclosure size

6	STK-Q-00600	2	M12 to M8 Adaptor
1	881 SP4224G	0	881 SP - Inner Panel
1	STK-K-01800	5	5412 ES Accessory Kit
1	5412ESFM422408THC	0	5412ESFM 42" x 24" Cover
1	5412ESFM422408THB	0	5412ESFM 42" x 24" x 8" Body
3	STK-Q-04050-08	0	M6 x 8mm Hexagon Socket Head Machine Screw
Qty	Part Number	Rev	Description
Parts List			

	Tél: (450) 979-4373 Fax: (450) 979-4626 www.exmweb.com	Flatness Aplatissement Max 3.0mm
	Projection 	Customer Client
Drawn By Dessiné Par	BoxCad: BoxCad	Date 24-Dec-24
Material Matière	16 Ga Cold Rolled A1008 CS Type B (1.4mm)	
Color Couleur	Asa-61 Grey	Finish Fini Smooth
Description 5412ESFM 42" x 24" x 8" Assembly		Detail Rev.
Part Number Numéro Pièce 5412ESFM422408TH		Rev. 2 0

This drawing is confidential and must not be reproduced or used without the consent of EXM

Ce dessin est confidentiel et ne doit pas être reproduit ou utilisé sans le consentement de EXM

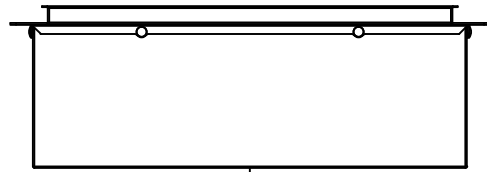

TOP

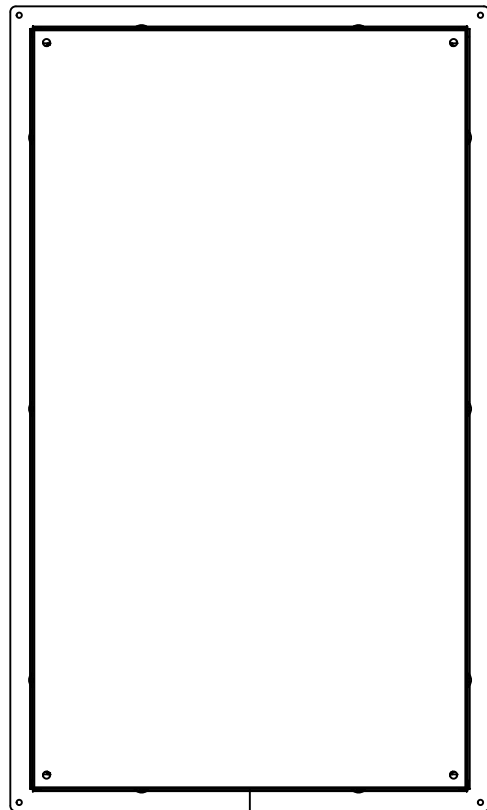

BACK

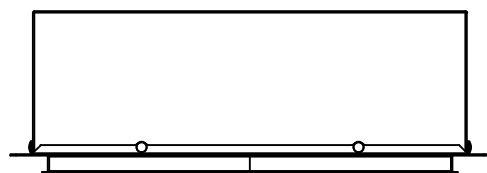

BOTTOM

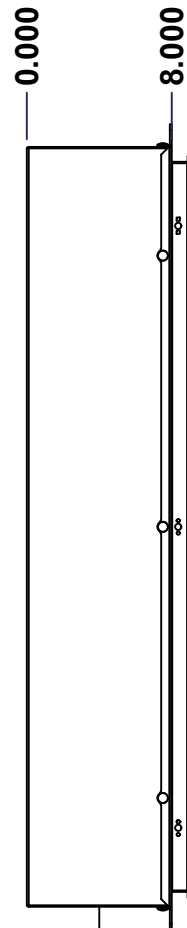

LEFT

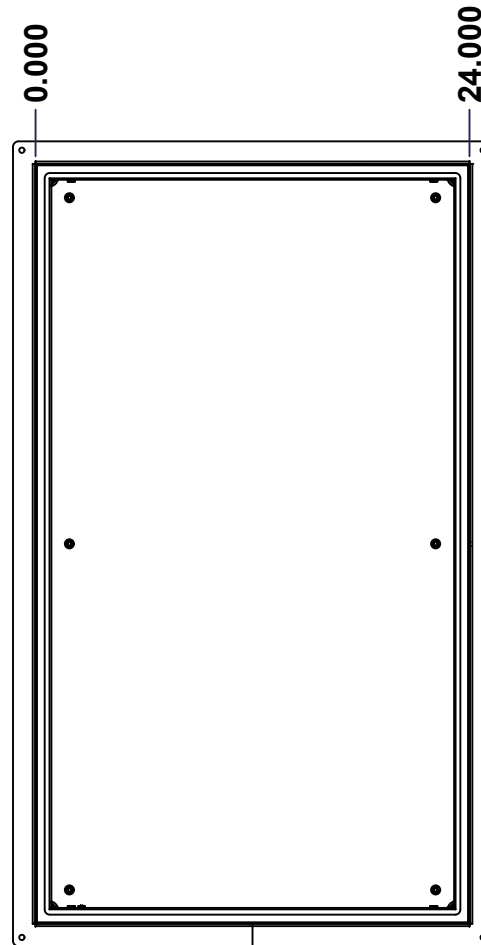

FRONT

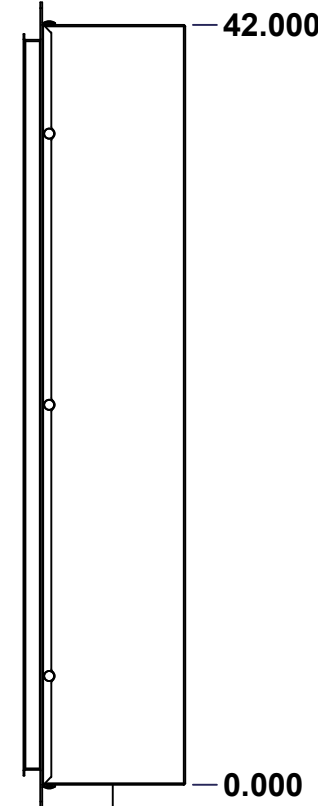

RIGHT

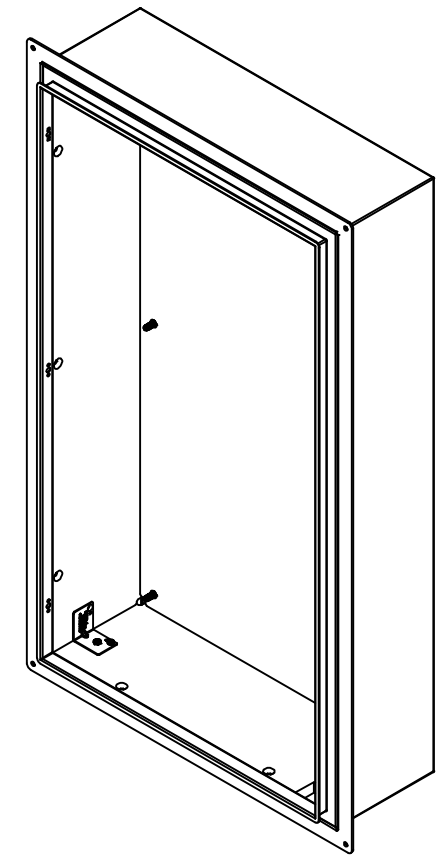

Isometric View

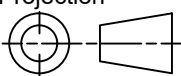

No.	Revisions	Date	By/Par

 Tél: (450) 979-4373 Fax: (450) 979-4626 www.exmweb.com		Flatness Aplatissement Max 3.0mm Projection 
Customer Client	Date	
Drawn By Dessiné Par	BoxCad: BoxCad	Date 24-Dec-24
Material Matière	16 Ga Cold Rolled A1008 CS Type B (1.4mm)	
Color Couleur	Asa-61 Grey	Finish Fini Smooth
Description	Detail Rev.	
5412ESFM 42" x 24" x 8" Body		
Part Number Numéro Pièce	Rev.	3
5412ESFM422408THB	0	19

SEE BILL OF MATERIAL ON LAST PAGE

This drawing is confidential and must not be reproduced or used without the consent of EXM

Ce dessin est confidentiel et ne doit pas être reproduit ou utilisé sans le consentement de EXM

STANDARD FEATURES ARE NOT LISTED IN THIS HOLE TABLE			
HOLE TABLE - TOP VIEW (CUSTOM FEATURE ONLY)			
CUT-OUT	XDIM	YDIM	DESCRIPTION
1	2.000	5.500	INSUL. STUD M6 x 18mm (Inside)
2	22.000	5.500	INSUL. STUD M6 x 18mm (Inside)

3	6.000	7.514	RND Ø0.290
4	18.000	7.514	RND Ø0.290

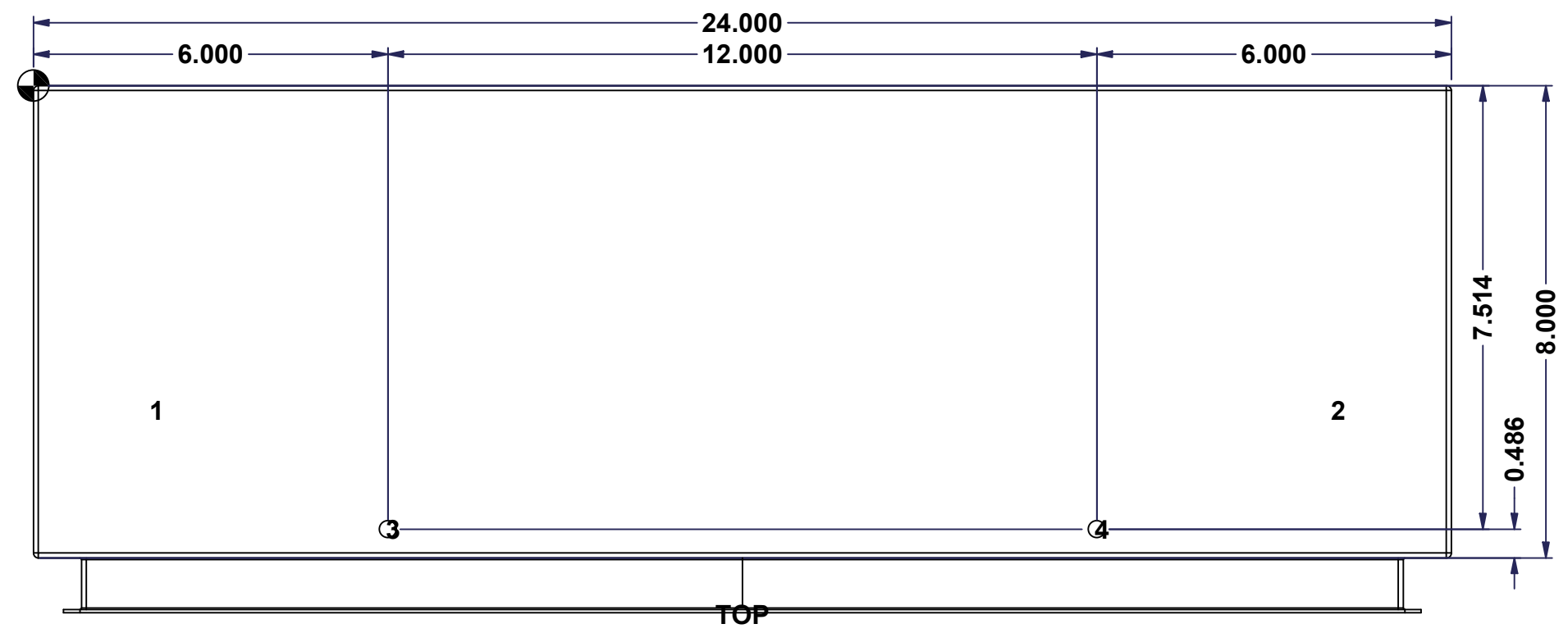

	Description	Status	
	5412ESFM 42" x 24" x 8" Body	(NULL)	
	Part Number Numéro Pièce	Rev.	4
	5412ESFM422408THB	0	19

This drawing is confidential and must not be reproduced or used without the consent of EXM

Ce dessin est confidentiel et ne doit pas être reproduit ou utilisé sans le consentement de EXM

STANDARD FEATURES ARE NOT LISTED IN THIS HOLE TABLE

HOLE TABLE - RIGHT VIEW (CUSTOM FEATURE ONLY)

CUT-OUT	XDIM	YDIM	DESCRIPTION
1	7.514	36.000	RND Ø0.290
2	7.514	6.000	RND Ø0.290
3	7.514	21.000	RND Ø0.290

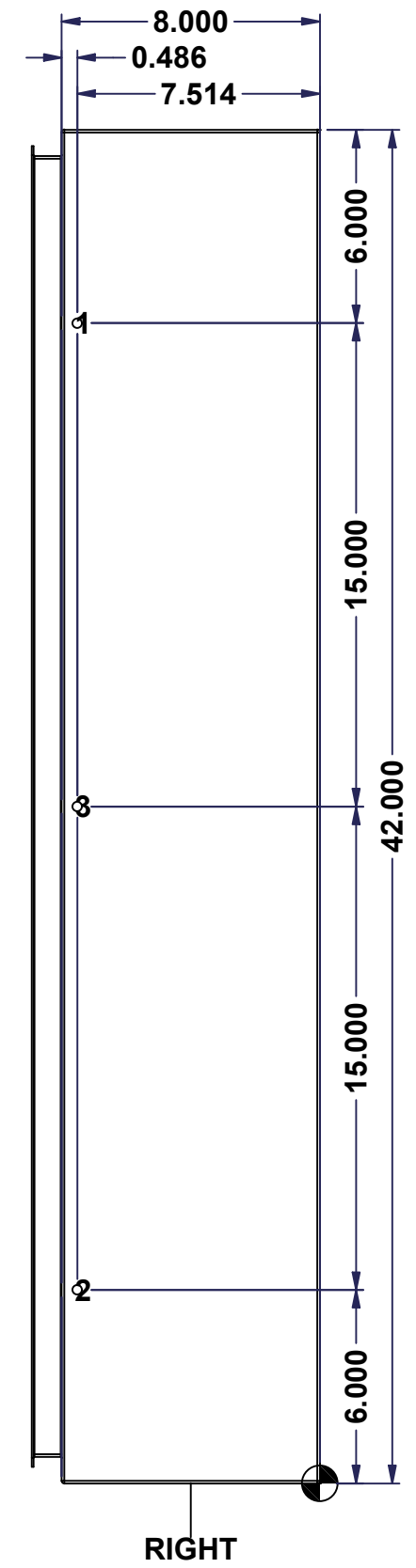

	Description	Status	
	5412ESFM 42" x 24" x 8" Body	(NULL)	
	Part Number Numéro Pièce	Rev.	5
	5412ESFM422408THB	0	19

This drawing is confidential and must not be reproduced or used without the consent of EXM

Ce dessin est confidentiel et ne doit pas être reproduit ou utilisé sans le consentement de EXM

STANDARD FEATURES ARE NOT LISTED IN THIS HOLE TABLE			
HOLE TABLE - BOTTOM VIEW (CUSTOM FEATURE ONLY)			
CUT-OUT	XDIM	YDIM	DESCRIPTION
1	2.000	5.500	INSUL. STUD M6 x 18mm (Inside)
2	22.000	5.500	INSUL. STUD M6 x 18mm (Inside)

3	6.000	7.514	RND Ø0.290
4	18.000	7.514	RND Ø0.290

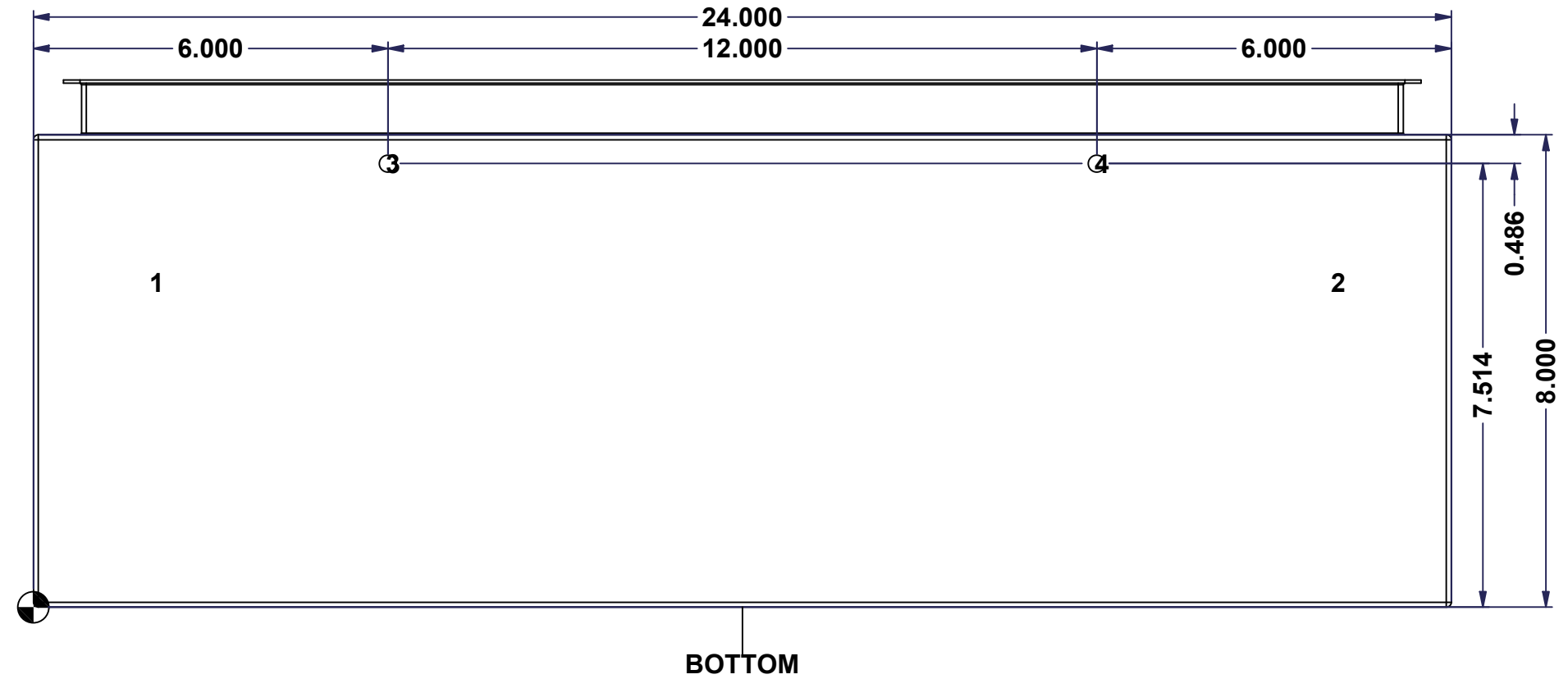

BOTTOM

	Description	Status
	5412ESFM 42" x 24" x 8" Body	(NULL)
	Part Number Numéro Pièce	Rev.
	5412ESFM422408THB	0
		6
		19

This drawing is confidential and must not be reproduced or used without the consent of EXM

Ce dessin est confidentiel et ne doit pas être reproduit ou utilisé sans le consentement de EXM

STANDARD FEATURES ARE NOT LISTED IN THIS HOLE TABLE			
HOLE TABLE - LEFT VIEW (CUSTOM FEATURE ONLY)			
CUT-OUT	XDIM	YDIM	DESCRIPTION
1	7.514	36.000	RND Ø0.290
2	7.514	6.000	RND Ø0.290
3	7.514	21.000	RND Ø0.290

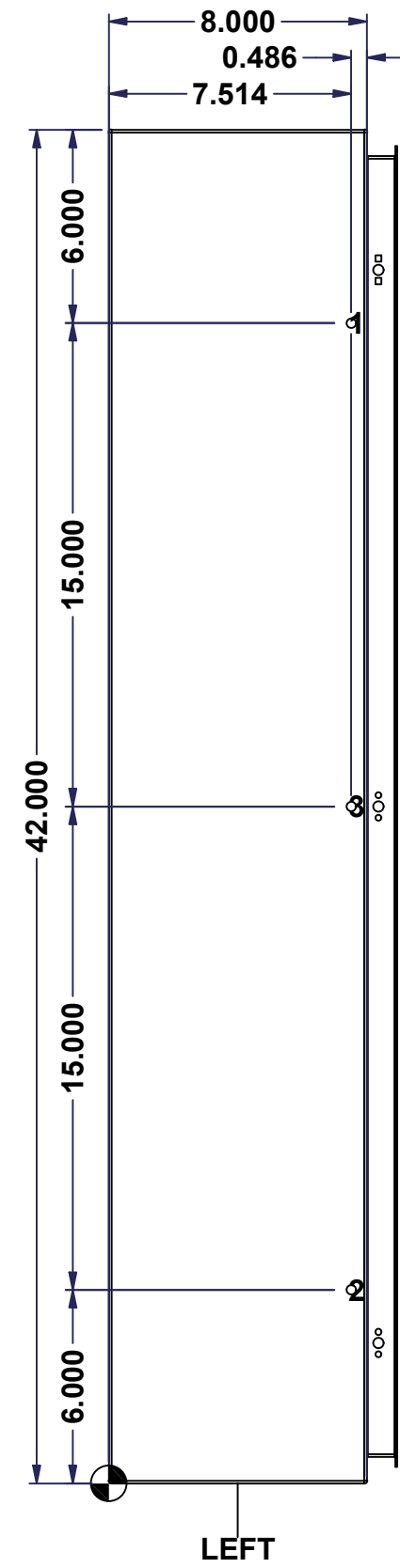

	Description	Status	
	5412ESFM 42" x 24" x 8" Body	(NULL)	
	Part Number Numéro Pièce	Rev.	7
	5412ESFM422408THB	0	19

This drawing is confidential and must not be reproduced or used without the consent of EXM

Ce dessin est confidentiel et ne doit pas être reproduit ou utilisé sans le consentement de EXM

STANDARD FEATURES ARE NOT LISTED IN THIS HOLE TABLE

HOLE TABLE - BACK VIEW (CUSTOM FEATURE ONLY)

CUT-OUT	XDIM	YDIM	DESCRIPTION
1	1.875	1.875	IP STUD M8 x 35mm (Inside)
2	1.875	40.125	IP STUD M8 x 35mm (Inside)
3	22.125	40.125	IP STUD M8 x 35mm (Inside)
4	22.125	1.875	IP STUD M8 x 35mm (Inside)
5	1.875	21.000	IP STUD M8 x 35mm (Inside)
6	22.125	21.000	IP STUD M8 x 35mm (Inside)

7	23.250	0.750	RND Ø0.390
8	23.250	41.250	RND Ø0.390
9	0.750	41.250	RND Ø0.390
10	0.750	0.750	RND Ø0.390

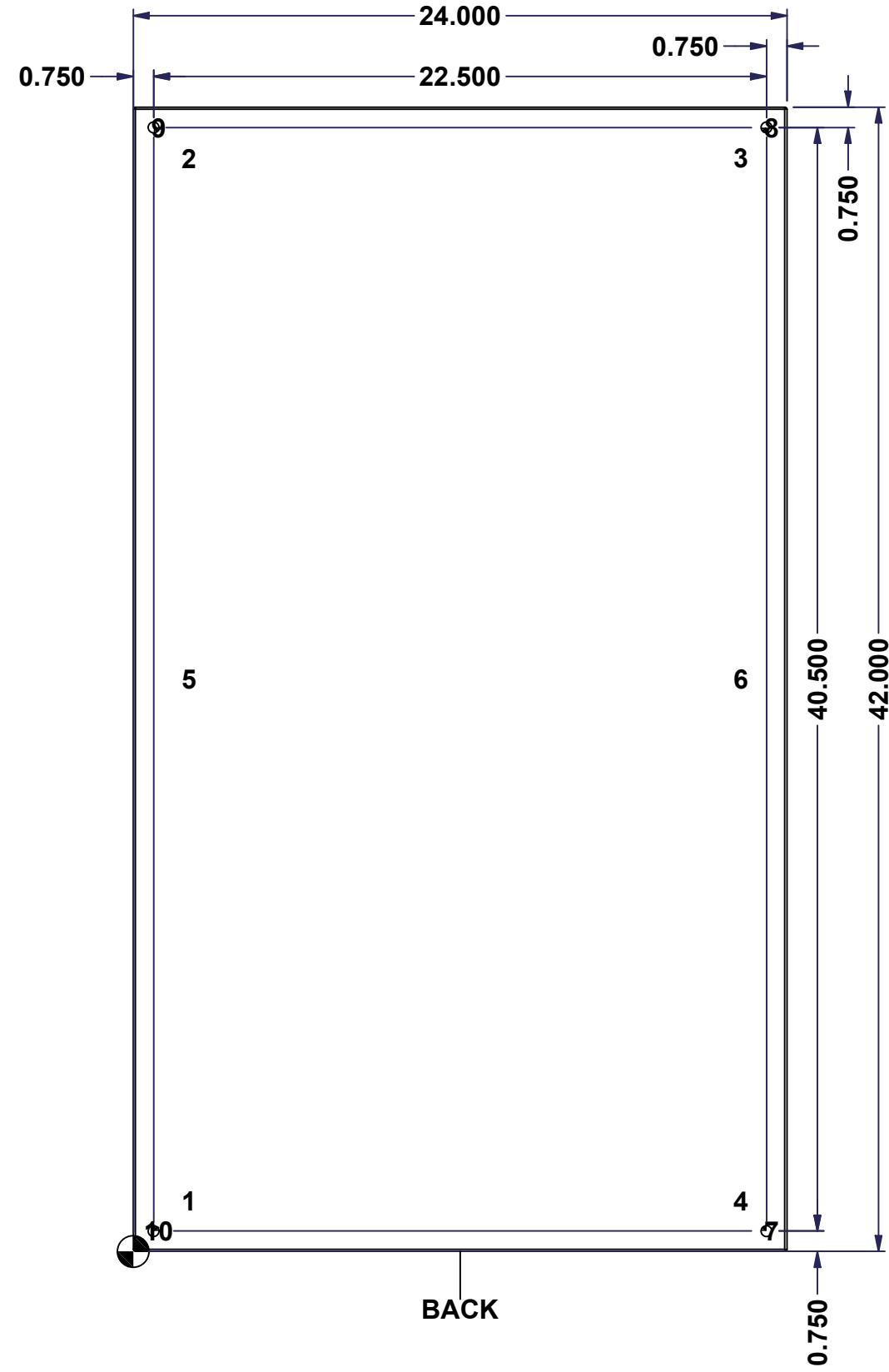

	Description	Status
	5412ESFM 42" x 24" x 8" Body	(NULL)
	Part Number Numéro Pièce	Rev.
	5412ESFM422408THB	0 / 8
		19

This drawing is confidential and must not be reproduced or used without the consent of EXM

Ce dessin est confidentiel et ne doit pas être reproduit ou utilisé sans le consentement de EXM

STANDARD FEATURES ARE NOT LISTED IN THIS HOLE TABLE			
HOLE TABLE - FRONT VIEW (CUSTOM FEATURE ONLY)			
CUT-OUT	XDIM	YDIM	DESCRIPTION
1	0.500	0.500	RND Ø0.290
2	0.500	44.000	RND Ø0.290
3	26.000	0.500	RND Ø0.290
4	26.000	44.000	RND Ø0.290

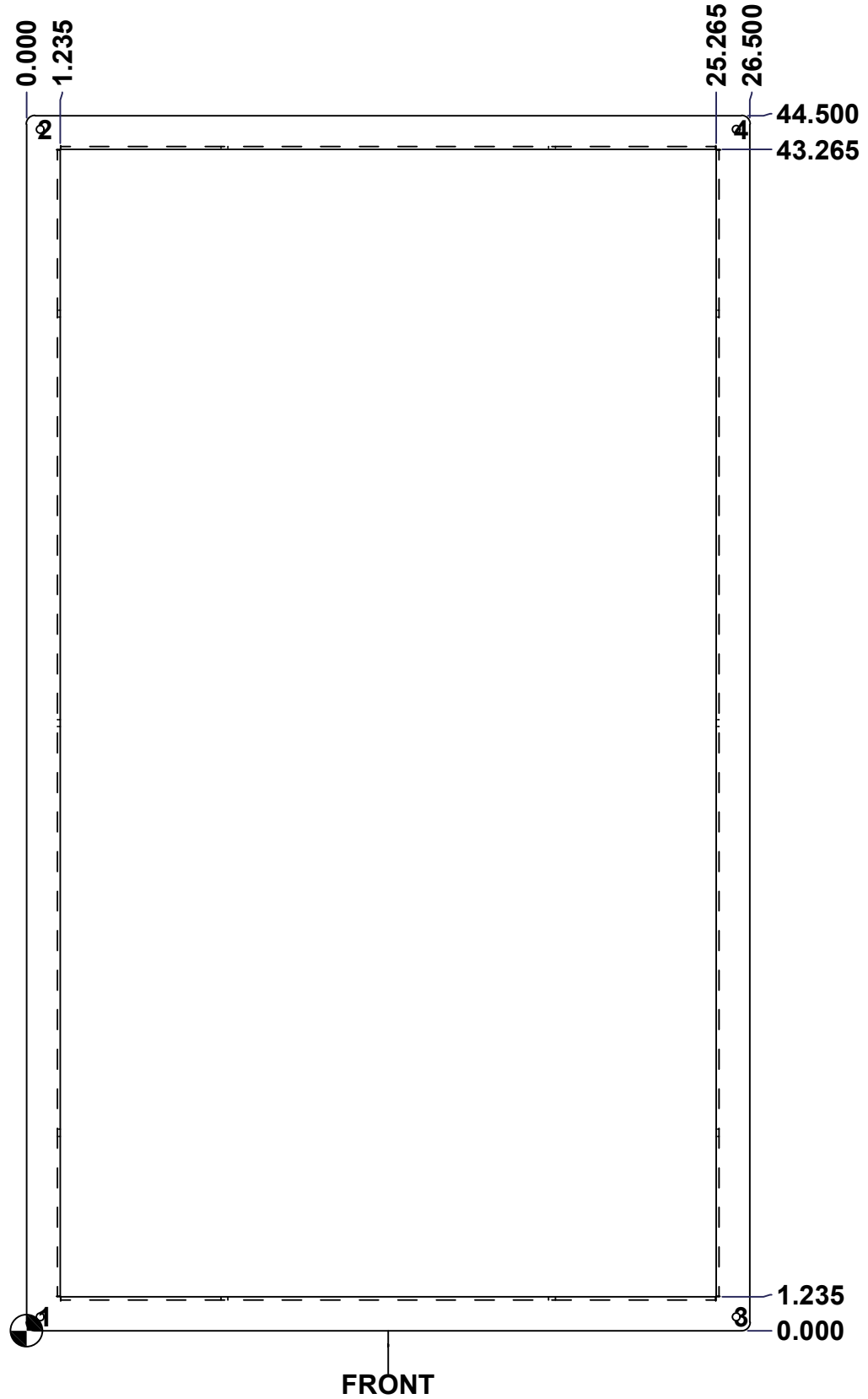

	Description	Status
	5412ESFM 42" x 24" x 8" Flange	(NULL)
	Part Number Numéro Pièce	Rev.
	5412ESFM422408THB	0 / 9
		19

This drawing is confidential and must not be reproduced or used without the consent of EXM

Ce dessin est confidentiel et ne doit pas être reproduit ou utilisé sans le consentement de EXM

No.	Revisions	Date	By/Par

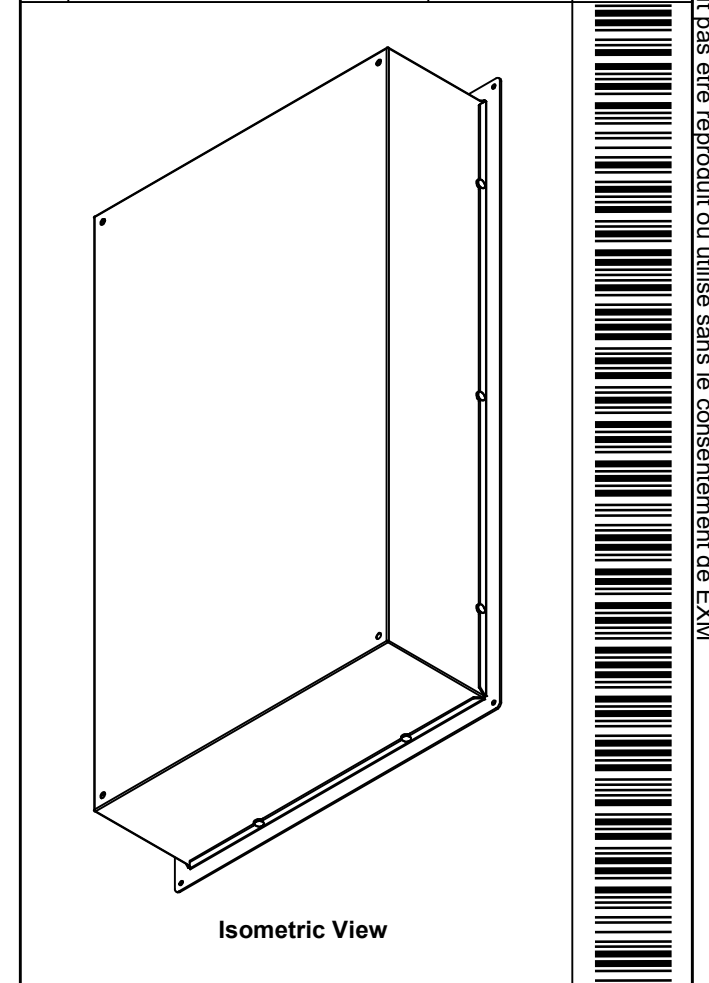

Isometric View

 Tél: (450) 979-4373
 Fax: (450) 979-4626
www.exmweb.com

Flatness
 Aplatissement
 Max 3.0mm
 Projection



1	STK-K-70554	3	5412 ESTH Accessory Kit
1	5412ESFM422408THI-RS	0	5412ESFM 42" x 24" Right Insulation
1	5412ESFM422408THI-LS	0	5412ESFM 42" x 24" Left Insulation
1	5412ESFM422408THI-BT	0	5412ESFM 42" x 24"Bottom Insulation
1	5412ESFM422408THI-TP	0	5412ESFM 42" x 24"Top Insulation
1	5412ESFM422408THI-B	0	5412ESFM 42" x 24" Back Insulation
4	STK-Q-16055	1	M6 x 18mm Stud (No Paint Cap Required)
1	5412ESFM422408THF	0	5412ESFM 42" x 24" x 8" Flange
1	STK-P-02400S	0	Powder Paint (Asa-61 Grey / Smooth)
6	STK-Q-16005	0	Stud M8 x 35mm Steel
1	5412ESFM422408THB-P	0	5412ESFM 42" x 24" x 8" Body Part

Customer Client	Date
Drawn By Dessiné Par BoxCad: BoxCad	Date 24-Dec-24
Material Matière 16 Ga Cold Rolled A1008 CS Type B (1.4mm)	
Color Couleur Asa-61 Grey	Finish Fini Smooth
Description 5412ESFM 42" x 24" x 8" Body	Detail Rev.
Part Number Numéro Pièce 5412ESFM422408THB	Rev. 10 0 19

Qty	Part Number	Rev	Description
Parts List			

This drawing is confidential and must not be reproduced or used without the consent of EXM

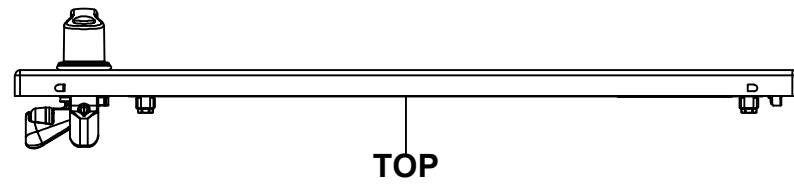
Ce dessin est confidentiel et ne doit pas être reproduit ou utilisé sans le consentement de EXM



TOP

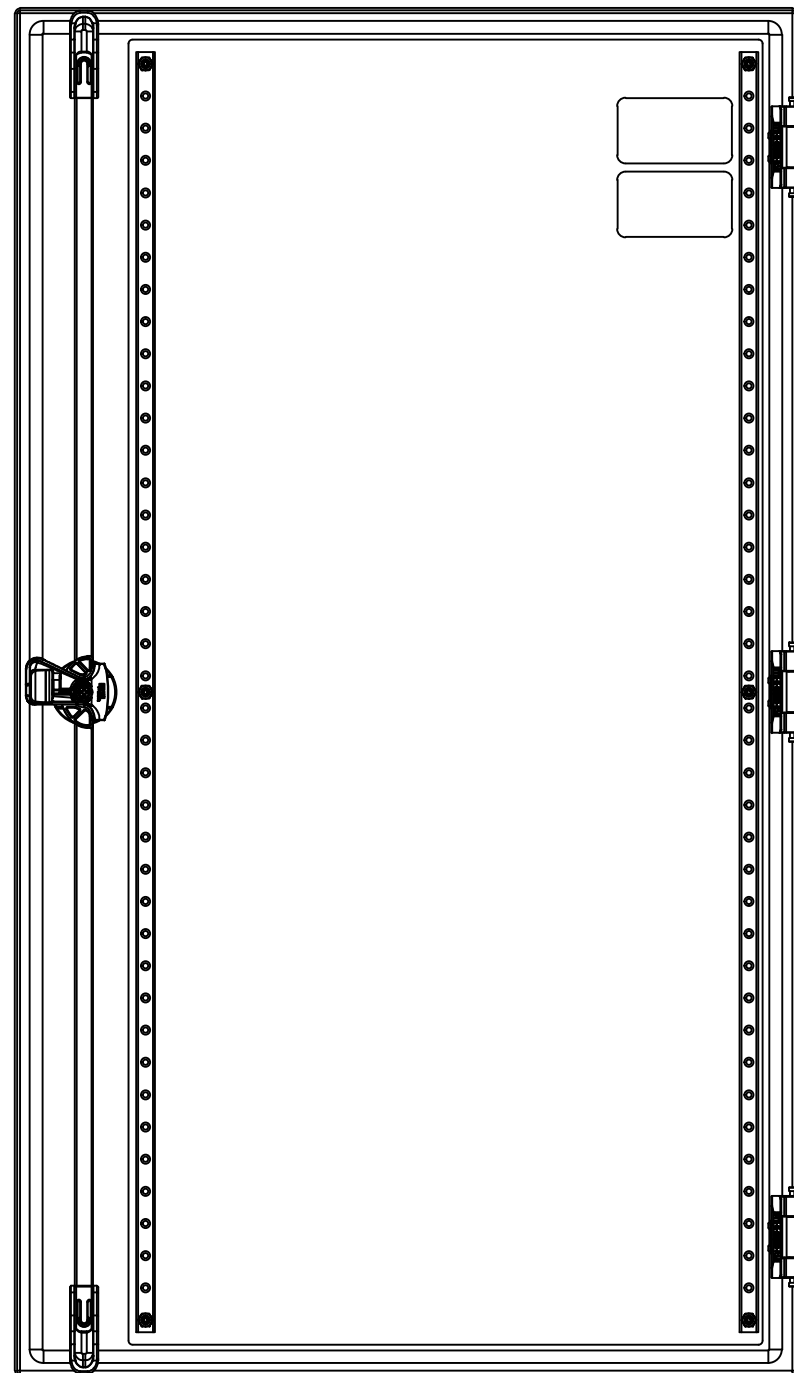

BACK



BOTTOM

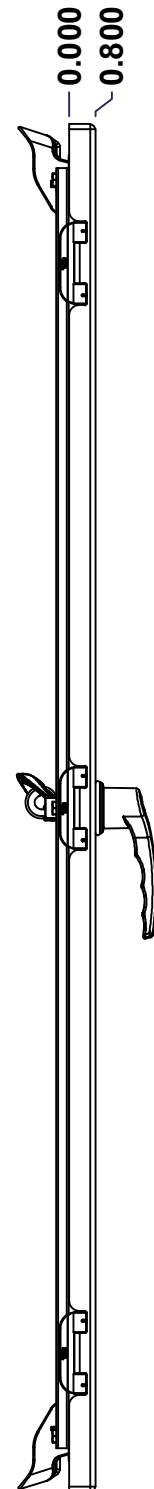

LEFT

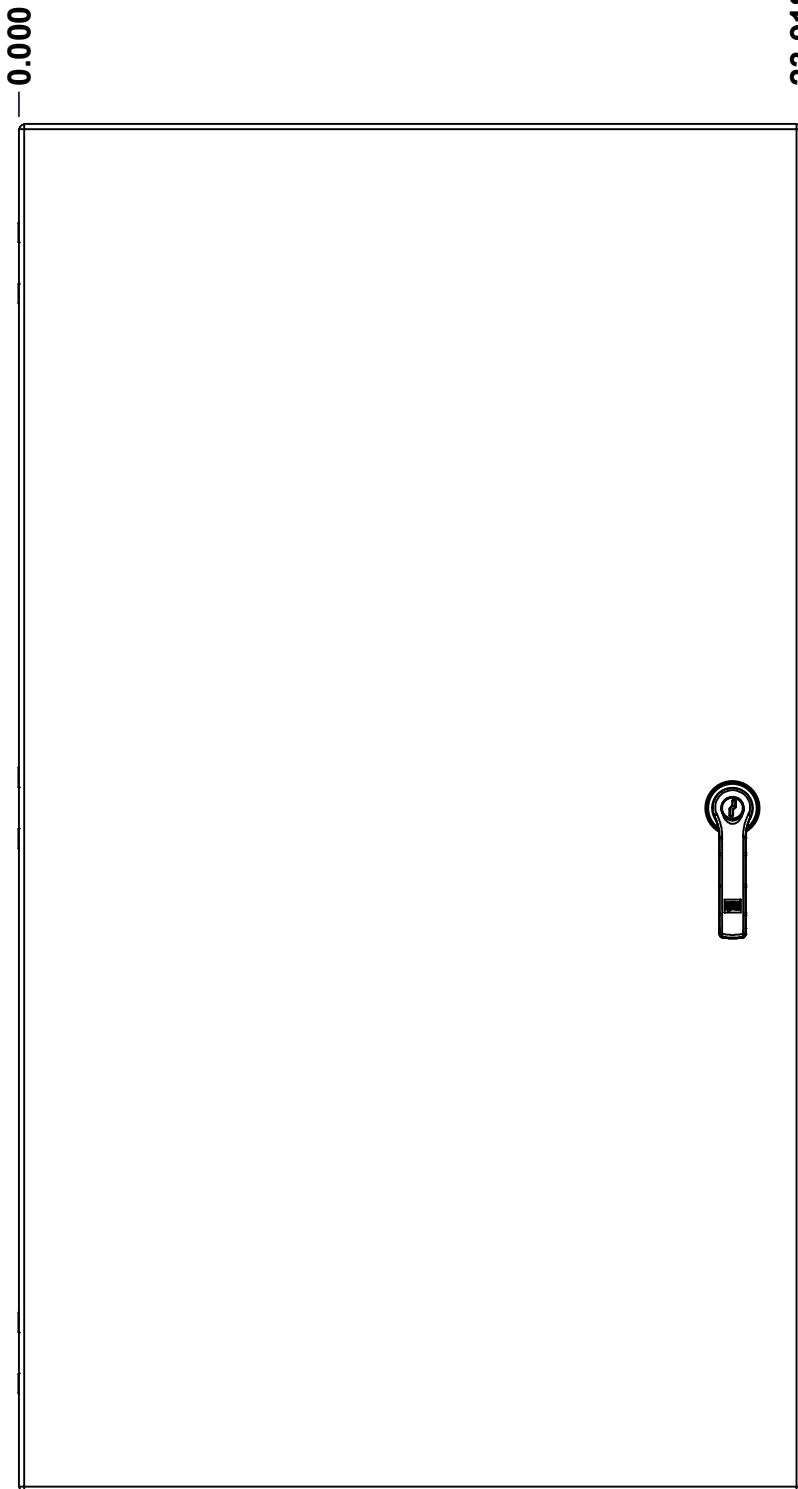

FRONT

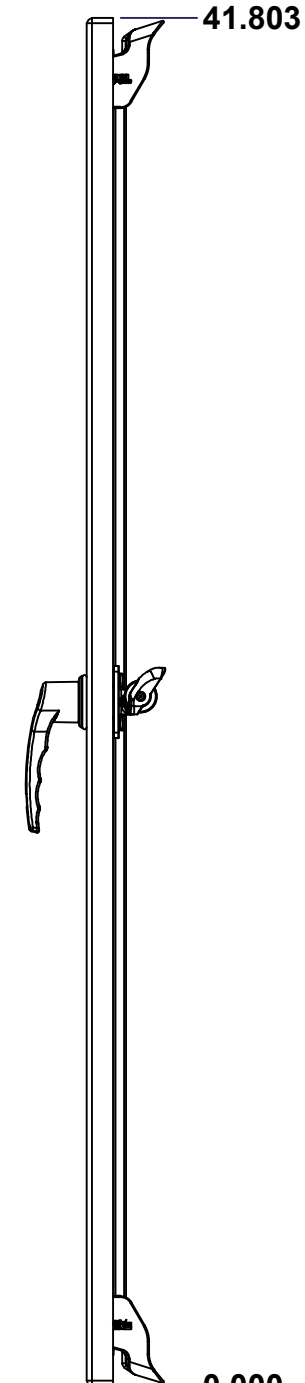

RIGHT

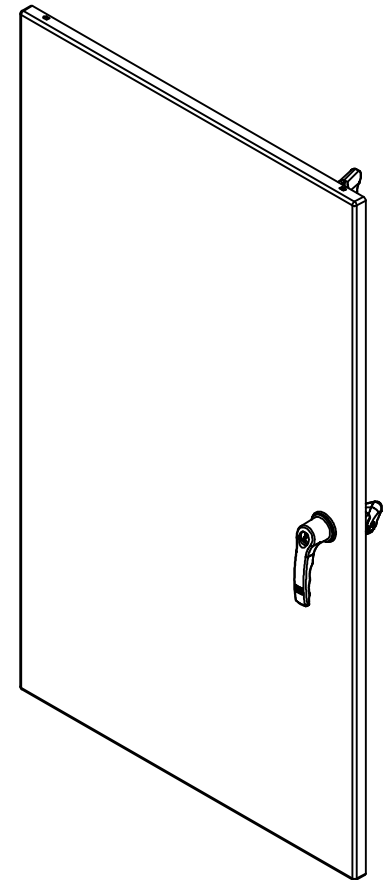

Isometric View

No.	Revisions	Date	By/Par

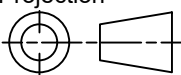

 Tél: (450) 979-4373 Fax: (450) 979-4626 www.exmweb.com		Flatness Aplatissement Max 3.0mm Projection 
Customer Client	Date	
Drawn By Dessiné Par	BoxCad: BoxCad	Date 24-Dec-24
Material Matière	14 Ga Cold Rolled A1008 CS Type B (1.7mm)	
Color Couleur	Asa-61 Grey	Finish Fini Smooth
Description	Detail Rev.	
5412ESFM 42" x 24" Cover		
Part Number Numéro Pièce	Rev.	11
5412ESFM422408THC	0	19

SEE BILL OF MATERIAL ON LAST PAGE

This drawing is confidential and must not be reproduced or used without the consent of EXM

Ce dessin est confidentiel et ne doit pas être reproduit ou utilisé sans le consentement de EXM

STANDARD FEATURES ARE NOT LISTED IN THIS HOLE TABLE			
HOLE TABLE - FRONT VIEW (CUSTOM FEATURE ONLY)			
CUT-OUT	XDIM	YDIM	DESCRIPTION
1	1.486	1.709	STUD M6 x 18mm (Inside)
2	1.486	40.094	STUD M6 x 18mm (Inside)
3	19.923	40.094	STUD M6 x 18mm (Inside)
4	19.923	1.709	STUD M6 x 18mm (Inside)
5	1.486	20.902	STUD M6 x 18mm (Inside)
6	19.923	20.902	STUD M6 x 18mm (Inside)
7	21.803	36.896	CLOSING BAR STUD (Inside)
8	21.803	4.907	CLOSING BAR STUD (Inside)
-----	-----	-----	-----
9	21.803	20.902	HANDLE 885 ESL2A @ 0.0°

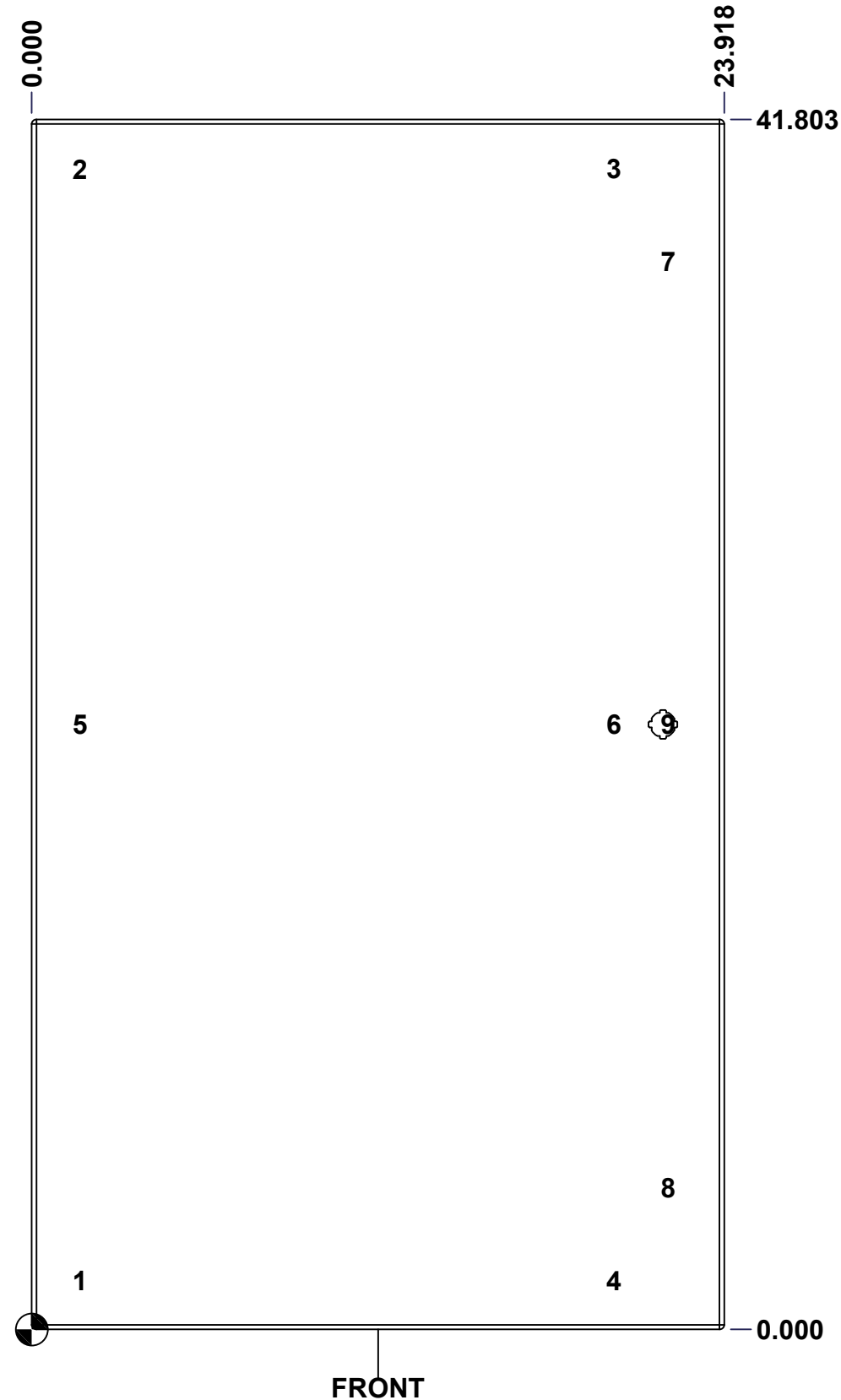

FRONT

	Description	Status
	5412ESFM 42" x 24" Cover	(NULL)
	Part Number Numéro Pièce	Rev.
	5412ESFM422408THC	0
		12
		19

This drawing is confidential and must not be reproduced or used without the consent of EXM

Ce dessin est confidentiel et ne doit pas être reproduit ou utilisé sans le consentement de EXM

No.	Revisions	Date	By/Par

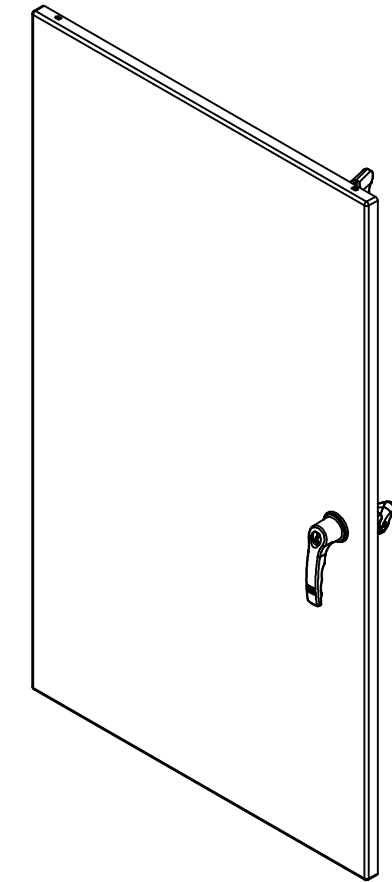

Isometric View



2	STK-Q-90042	4	5412 ES - Cabinet Closing Bar End (Small)
2	STK-Q-45655-42	0	5412 ES - Closing Bar
1	STK-A-50536	15	5412 ES Handle Cam Assembly (Right Side, Grip 32mm)
1	STK-Q-90051	3	5412 ES - Handle Cam Spacer
1	885 ESL2A	4	5412 ES Key Lock L-Handle (3 Pts)
2	STK-S-00100	0	3.5" x 2" Silver Milar Flexcon Sticker
6	STK-Q-07250	2	M6 x 16mm Collar Nut
2	STK-Q-46020-42	6	5412 ES Vertical Door Stiffener 42"
1	5412ESFM422408THI-C	0	5412ESFM 42" x 24" Cover Insulation
1	STK-P-02400S	0	Powder Paint (Asa-61 Grey / Smooth)
2	STK-Q-16405	7	Guide Stud - Small (No Paint Cap Required)
6	STK-Q-16055	1	M6 x 18mm Stud (No Paint Cap Required)
1	5412ESFM422408THG	0	5412ESFM 42" x 24" Cover Gasket Part
1	5412ESFM422408THC-P	0	5412ESFM 42" x 24" Cover Part
3	STK-K-09800	10	5412 ES Hinge with 2 Captive Hinge Pins

QTY	Part Number	Rev	Description
Parts List			

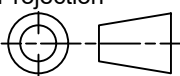
 Tél: (450) 979-4373 Fax: (450) 979-4626 www.exmweb.com		Flatness Aplatissement Max 3.0mm Projection 
Customer Client	Date	
Drawn By Dessiné Par	BoxCad: BoxCad	Date 24-Dec-24
Material Matière	14 Ga Cold Rolled A1008 CS Type B (1.7mm)	
Color Couleur	Asa-61 Grey	Finish Fini Smooth
Description		Detail Rev.
5412ESFM 42" x 24" Cover		
Part Number Numéro Pièce	Rev.	13
5412ESFM422408THC	0	19

This drawing is confidential and must not be reproduced or used without the consent of EXM

Ce dessin est confidentiel et ne doit pas être reproduit ou utilisé sans le consentement de EXM

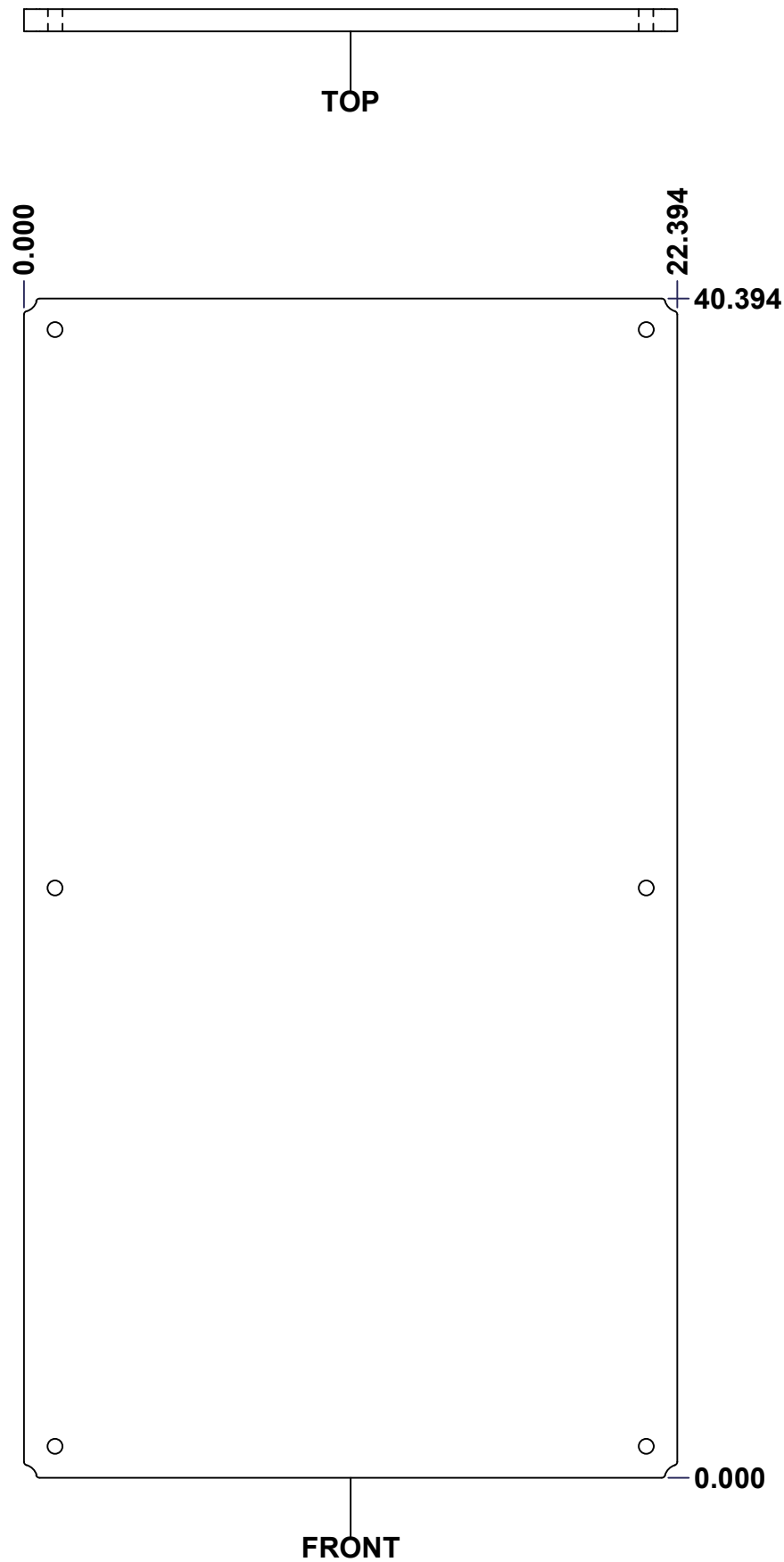

No.	Revisions	Date	By/Par

Isometric View

<p>Tél: (450) 979-4373 Fax: (450) 979-4626 www.exmweb.com</p>		Flatness Aplatissement	
		Max 3.0mm	
Customer Client		Date	
Drawn By Dessiné Par		Date	
Material Matière		Polyisocyanurate	
Color Couleur		Aluminum	Finish Fini
Description		Detail Rev.	
5412ESFM 42" x 24" Back Insulation			
Part Number Numéro Pièce		Rev.	
5412ESFM422408THI-B		0	14 19

SEE BILL OF MATERIAL ON LAST PAGE

This drawing is confidential and must not be reproduced or used without the consent of EXM

Ce dessin est confidentiel et ne doit pas être reproduit ou utilisé sans le consentement de EXM

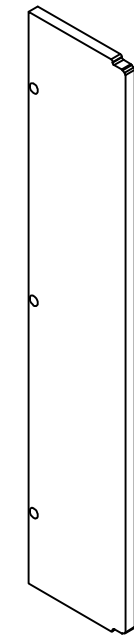
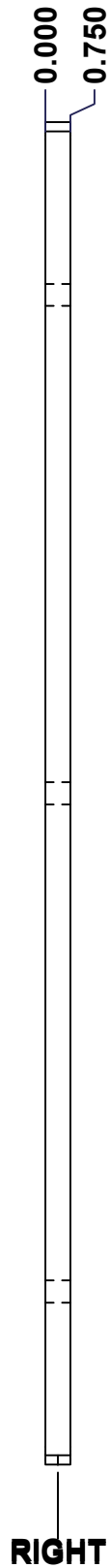
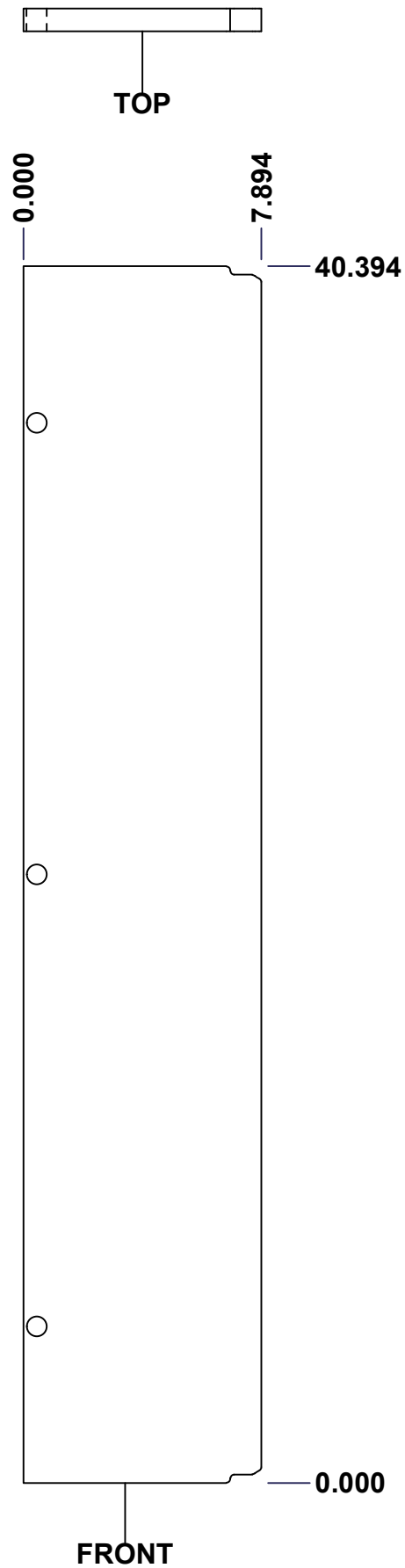

Isometric View



Tél: (450) 979-4373
 Fax: (450) 979-4626
www.exmweb.com

Flatness
Aplatissement

Max 3.0mm

Projection

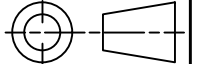

Customer Client	Date
Drawn By Dessiné Par	Date 23-Jan-07
Material Matière	Polyisocyanurate
Color Couleur	Aluminum
Finish Fini	N/A
Description	Detail Rev.
5412ESFM 42" x 24" Left Insulation	
Part Number Numéro Pièce	Rev. 15
5412ESFM422408THI-LS	0 19

SEE BILL OF MATERIAL ON LAST PAGE

This drawing is confidential and must not be reproduced or used without the consent of EXM

Ce dessin est confidentiel et ne doit pas être reproduit ou utilisé sans le consentement de EXM

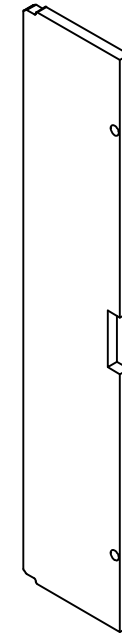
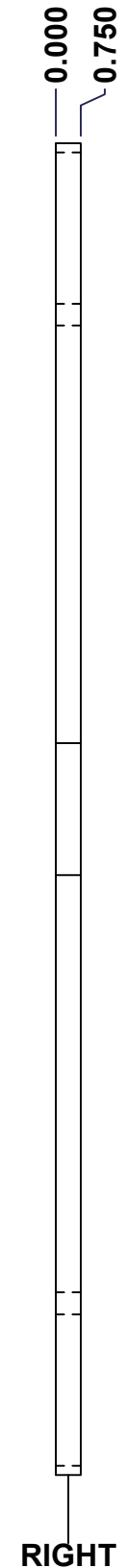
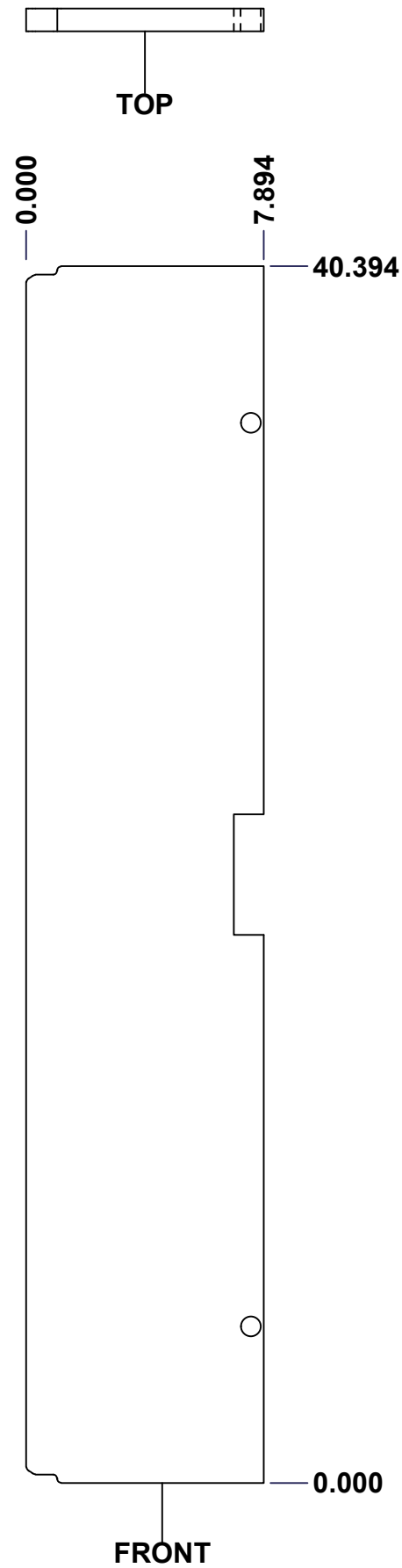

Isometric View



Tél: (450) 979-4373
 Fax: (450) 979-4626
www.exmweb.com

Flatness
Aplatissement

Max 3.0mm

Projection

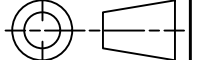

Customer Client	Date
Drawn By Dessiné Par	Date 23-Jan-07
Material Matière	Polyisocyanurate
Color Couleur	Aluminum
Finish Fini	N/A
Description	Detail Rev.
5412ESFM 42" x 24" Right Insulation	
Part Number Numéro Pièce	Rev. 16
5412ESFM422408THI-RS	0 19

SEE BILL OF MATERIAL ON LAST PAGE

This drawing is confidential and must not be reproduced or used without the consent of EXM

Ce dessin est confidentiel et ne doit pas être reproduit ou utilisé sans le consentement de EXM

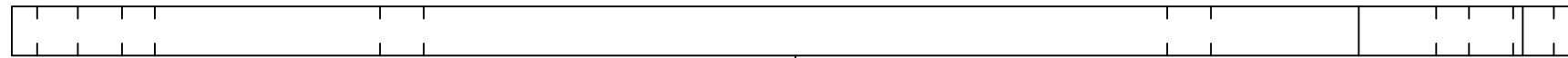

TOP

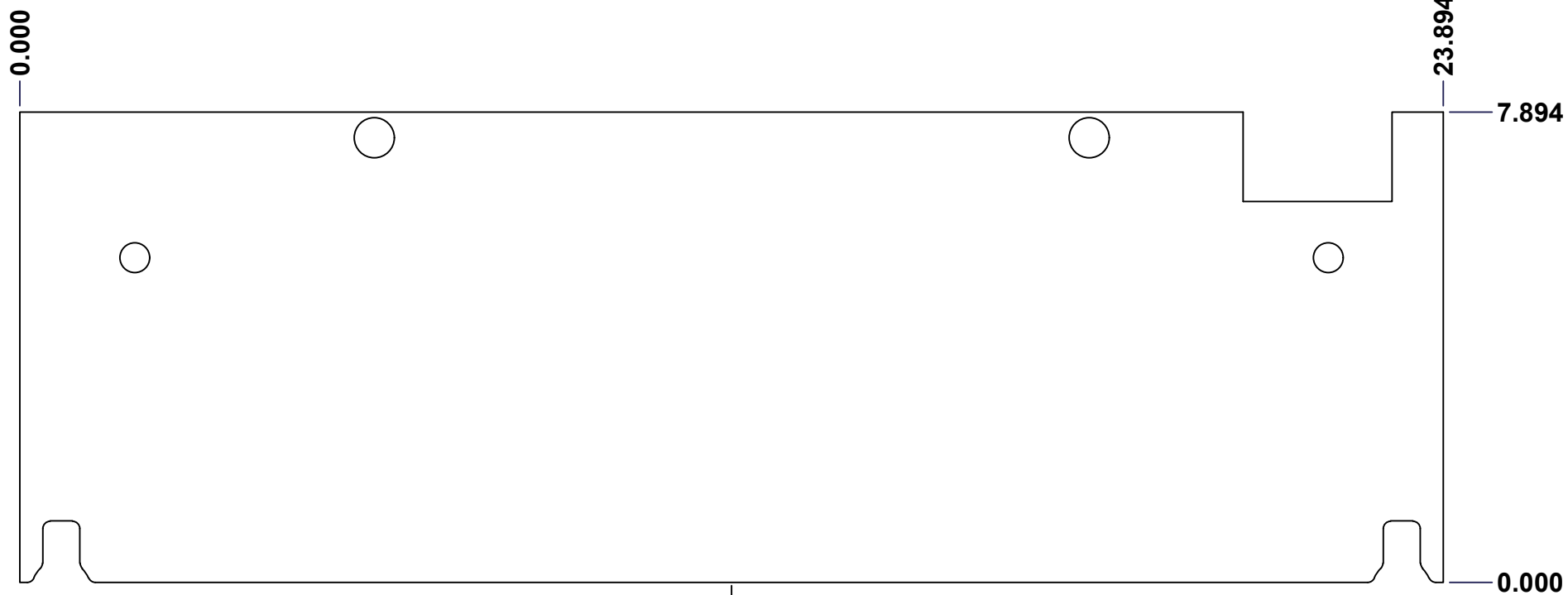

FRONT

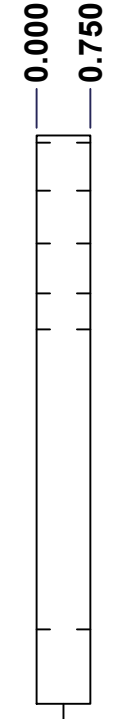

RIGHT

No.	Revisions	Date	By/Par

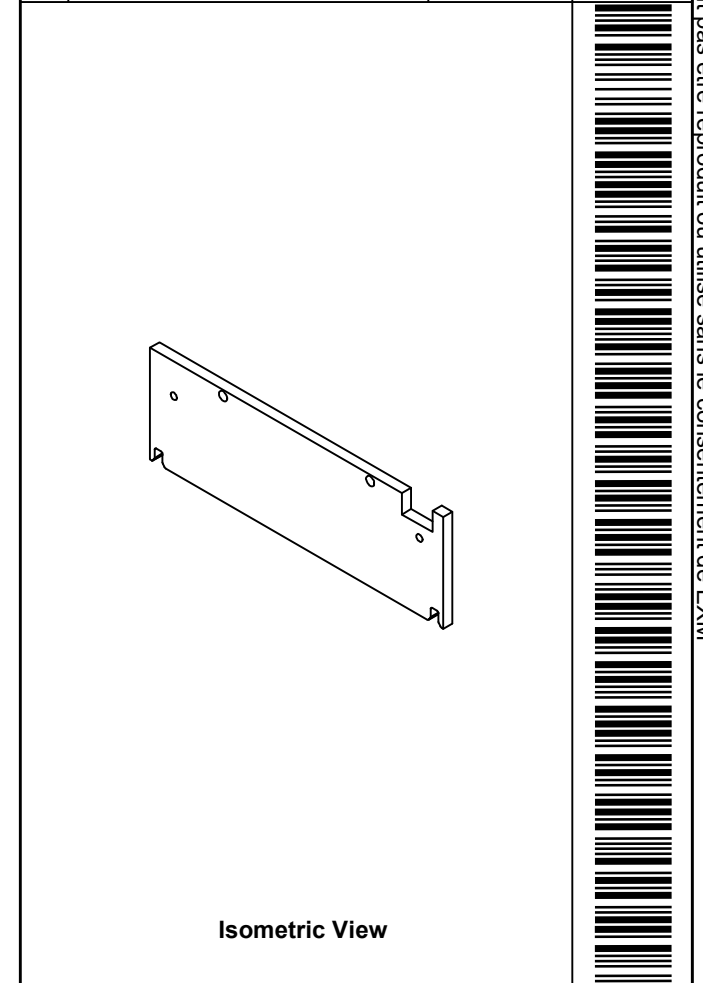

Isometric View



Tél: (450) 979-4373
 Fax: (450) 979-4626
www.exmweb.com

Flatness
Aplatissement
Max 3.0mm
Projection

Customer Client	Date
Drawn By / Dessiné Par: BoxCad: BoxCad	Date: 4/3/2024
Material / Matière: Polyisocyanurate	
Color / Couleur: Aluminum	Finish / Fini: Smooth
Description: 5412ESFM 42" x 24"Top Insulation	Detail Rev.
Part Number / Numéro Pièce: 5412ESFM422408THI-TP	Rev. 0

SEE BILL OF MATERIAL ON LAST PAGE

This drawing is confidential and must not be reproduced or used without the consent of EXM

Ce dessin est confidentiel et ne doit pas être reproduit ou utilisé sans le consentement de EXM

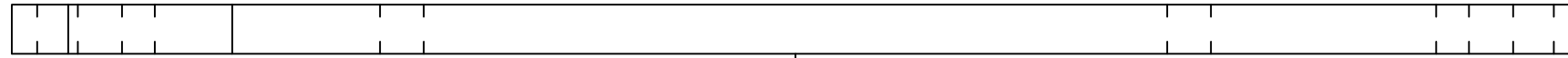

TOP

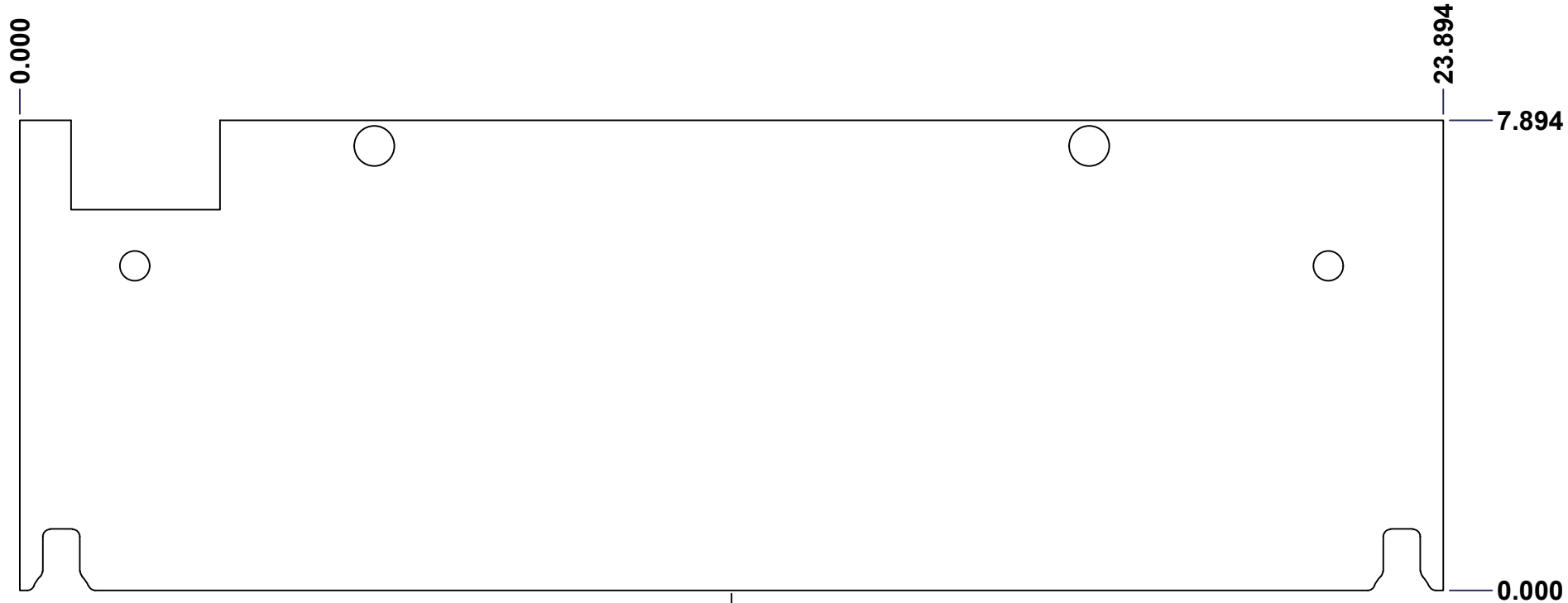

FRONT

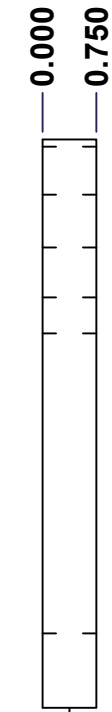

RIGHT

No.	Revisions	Date	By/Par

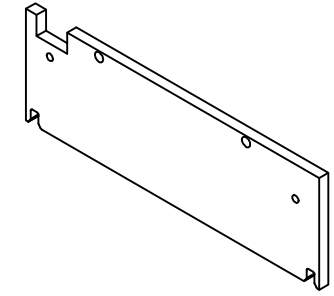

Isometric View



Tél: (450) 979-4373
 Fax: (450) 979-4626
www.exmweb.com

Flatness
Aplatissement
Max 3.0mm
Projection

Customer Client	Date
Drawn By / Dessiné Par: BoxCad: BoxCad	Date: 4/3/2024
Material / Matière: Polyisocyanurate	
Color / Couleur: Aluminum	Finish / Fini: Smooth
Description: 5412ESFM 42" x 24"Bottom Insulation	Detail Rev.
Part Number / Numéro Pièce: 5412ESFM422408THI-BT	Rev. 18
SEE BILL OF MATERIAL ON LAST PAGE	0 19

This drawing is confidential and must not be reproduced or used without the consent of EXM

Ce dessin est confidentiel et ne doit pas être reproduit ou utilisé sans le consentement de EXM

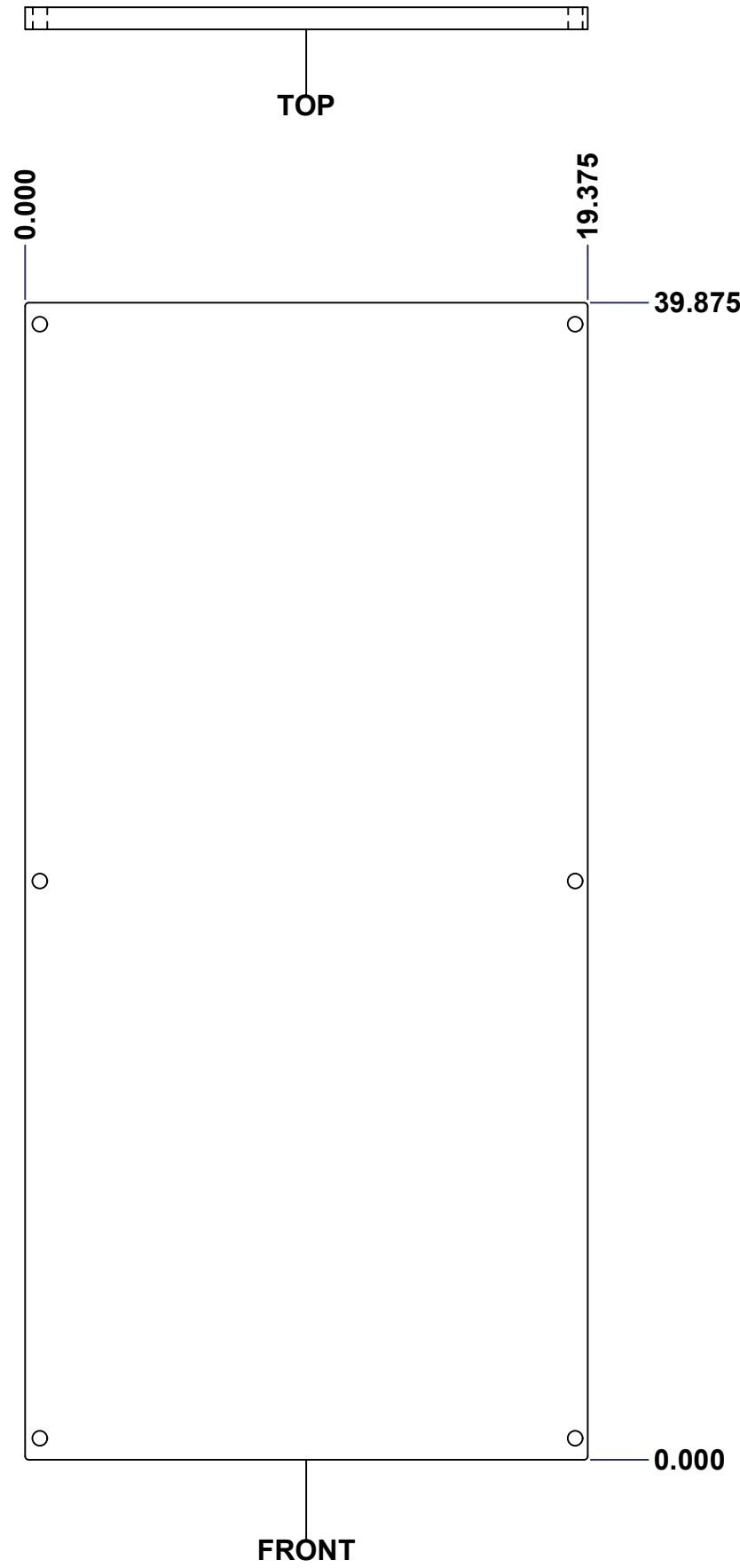

No.	Revisions	Date	By/Par

Isometric View

<p>Tél: (450) 979-4373 Fax: (450) 979-4626 www.exmweb.com</p>		Flatness Aplatissement
		Max 3.0mm
		Projection
Customer Client	Date	
Drawn By Dessiné Par	BoxCad: Patrick Deschenes	Date 23-Jan-07
Material Matière: Polyisocyanurate		
Color Couleur: Aluminum	Finish Fini: N/A	
Description 5412ESFM 42" x 24" Cover Insulation		Detail Rev.
Part Number Numéro Pièce: 5412ESFM422408THI-C	Rev. 0	19 / 19

SEE BILL OF MATERIAL ON LAST PAGE

This drawing is confidential and must not be reproduced or used without the consent of EXM

Tolerance ±1/32" unless otherwise specified

C:\Vault Workspace\Inventor Dwg\Inv-8\881SP\881SP4224G.idw

Tolérance ±1/32" sauf spécification contraire

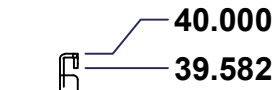
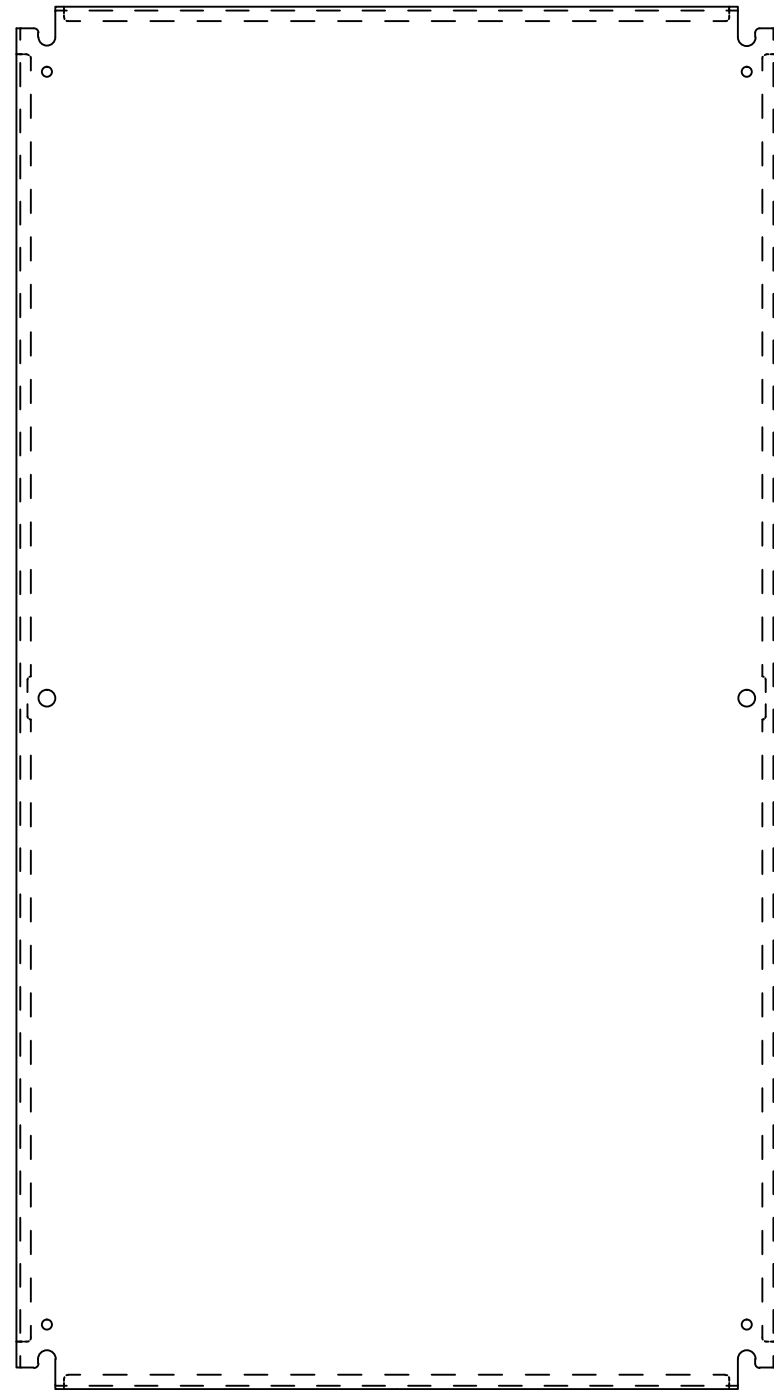
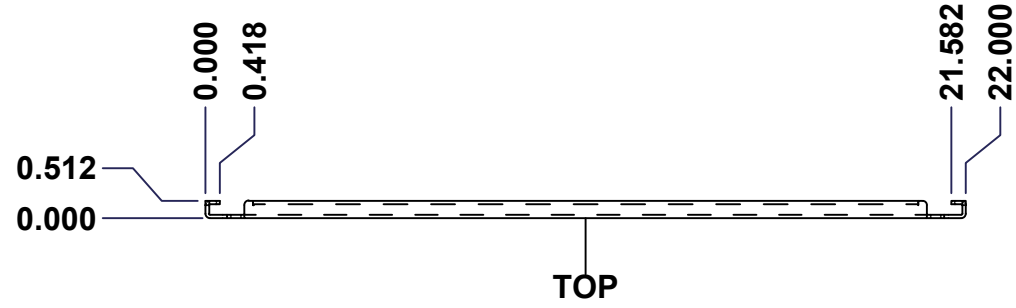

No.	Revisions	Date	By/Par

Isometric View

		Flatness Aplatissement Max 3.0mm	
Tél: (450) 979-4373 Fax: (450) 979-4626 www.exmweb.com		Projection 	
Customer Client		Date	
Drawn By Dessiné Par BoxCad		Date 23-Jan-07	
Material Matière		See Part List	
Color Couleur	See Part List	Finish Fini	See Part List
Description		Detail Rev.	
881 SP - Inner Panel			
Part Number Numéro Pièce		Rev.	1
881 SP4224G		0	2

Qty	Part Number	Rev	Description	Material	Color	Finish
1	881 SP4224G-P	0	881 SP - Inner Panel Part	12 Ga Galvanized	Unpainted	Galvanized

Parts List

Ce dessin est confidentiel et ne doit pas être reproduit ou utilisé sans le consentement de EXM

This drawing is confidential and must not be reproduced or used without the consent of EXM

Ce dessin est confidentiel et ne doit pas être reproduit ou utilisé sans le consentement de EXM

Table 1			FRONT VIEW
CUT-OUT	XDIM	YDIM	DESCRIPTION
1	0.875	1.875	GROUND HOLE (RND Ø0.290)
2	21.125	1.875	GROUND HOLE (RND Ø0.290)
3	0.875	38.125	GROUND HOLE (RND Ø0.290)
4	21.125	38.125	GROUND HOLE (RND Ø0.290)
5	0.875	20.000	MTG STUD HOLE (RND Ø0.500)
6	21.125	20.000	MTG STUD HOLE (RND Ø0.500)

All knockouts are actual size / Les disques défonçables sont grandeur réel

No.	Revisions	Date	By/Par

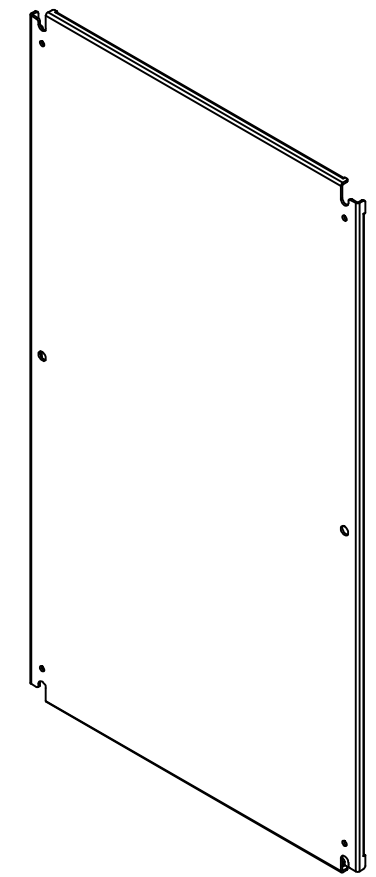
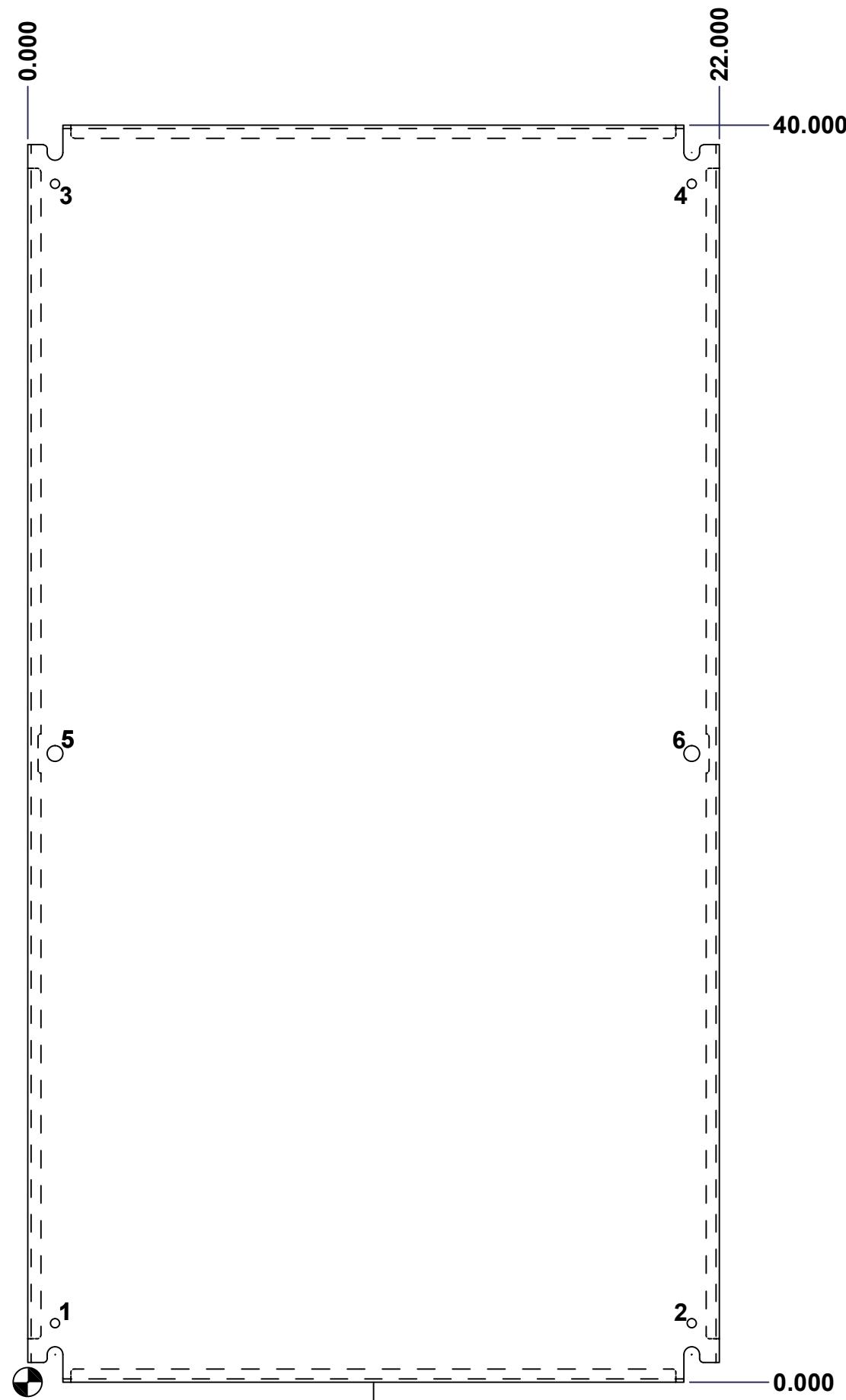

Isometric View



	Tél: (450) 979-4373 Fax: (450) 979-4626 www.exmweb.com	Flatness Aplatissement
		Max 3.0mm
Projection		
Customer Client		Date
Drawn By Dessiné Par	BoxCad	Date 23-Jan-07
Material Matière	See Part List	
Color Couleur	See Part List	Finish Fini See Part List
Description	Detail Rev.	
881 SP - Inner Panel		
Part Number Numéro Pièce	Rev.	2
881 SP4224G	0	2