

This drawing is confidential and must not be reproduced or used without the consent of EXM

Ce dessin est confidentiel et ne doit pas être reproduit ou utilisé sans le consentement de EXM

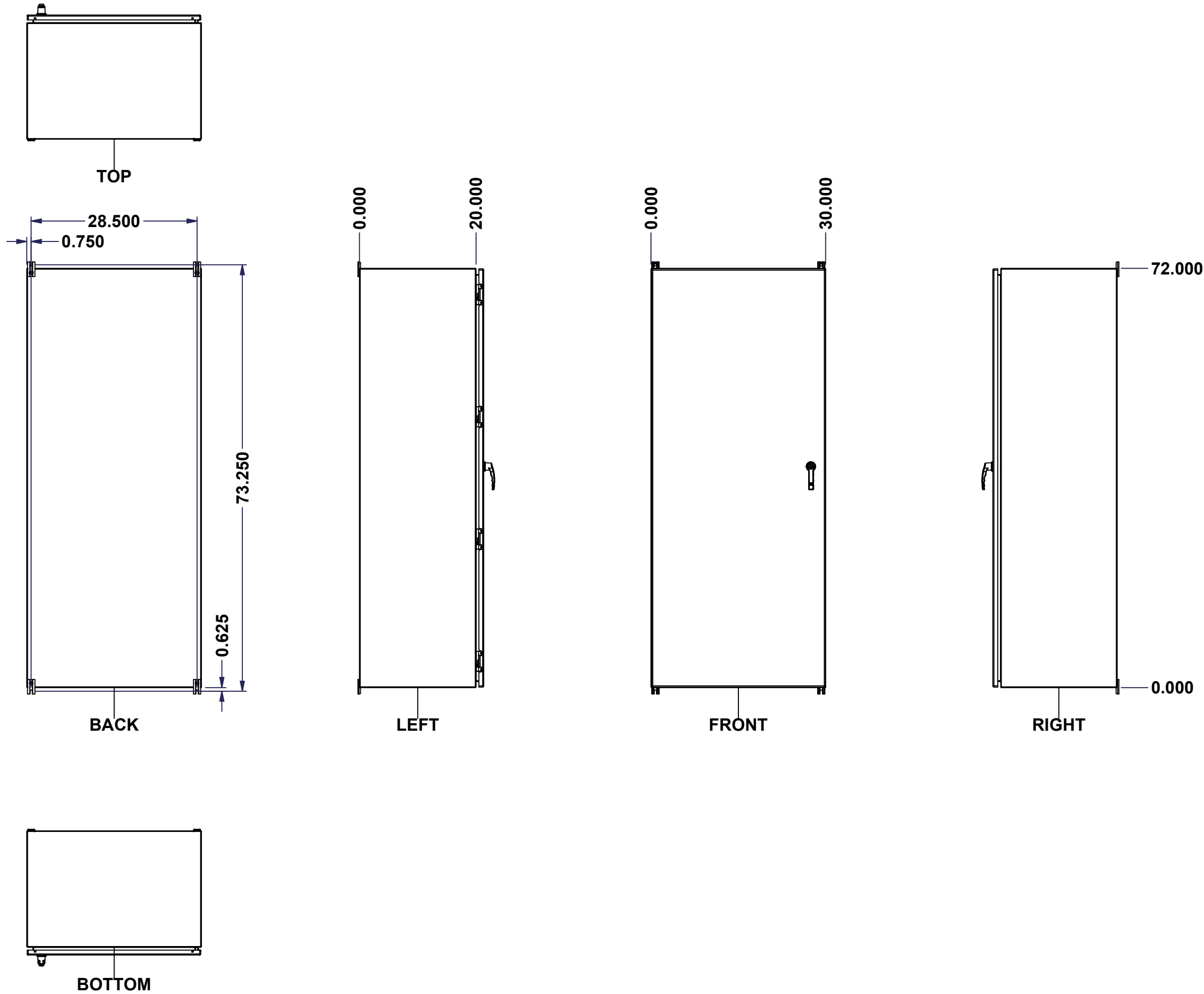

No.	Revisions	Date	By/Par

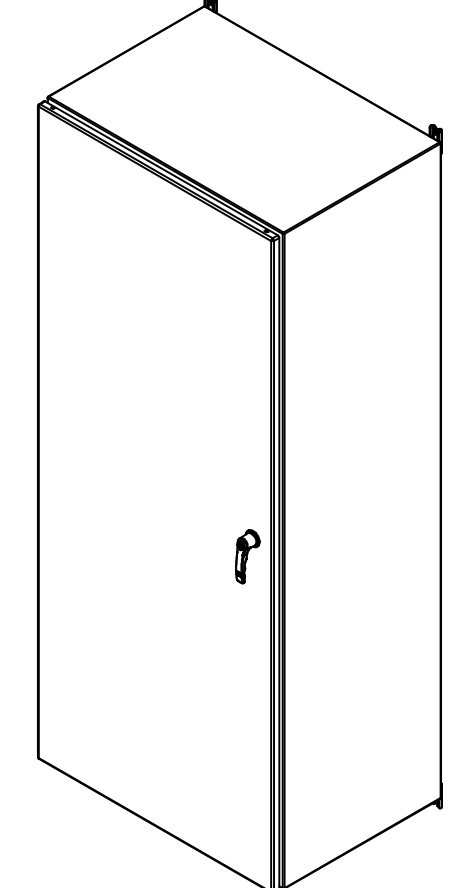

Isometric View

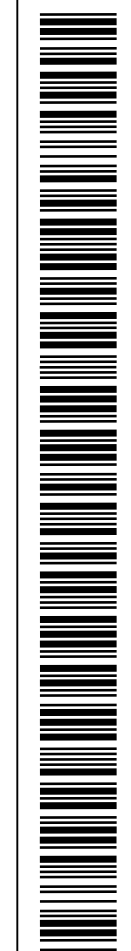

 Tél: (450) 979-4373 Fax: (450) 979-4626 www.exmweb.com		Flatness Aplatissement	
		Max 3.0mm	
Customer Client		Date	
Drawn By Dessiné Par BoxCad: BoxCad		Date 29-Dec-24	
Material Matière 12 Ga Cold Rolled A1008 CS Type B (2.5mm)			
Color Couleur Asa-61 Grey		Finish Fini Smooth	
Description 5412ESHD 72" x 30" x 20" Assembly			Detail Rev.
Part Number Numéro Pièce 5412ESHD723020TH		Rev. 0	1 / 16

SEE BILL OF MATERIAL ON LAST PAGE

This drawing is confidential and must not be reproduced or used without the consent of EXM

Ce dessin est confidentiel et ne doit pas être reproduit ou utilisé sans le consentement de EXM

NOTE	
ITEM	DESCRIPTION
1	NEMA 4, 12 Enclosure (IP66)
2	C/W Standard ground studs on box and cover
3	C/W Standard door stiffener
4	C/W Standard inner panel (Included)
5	C/W Standard inner panel mounting studs
6	C/W 885 ESMF3_OPEN Sold separately (Installed)
7	C/W 885 ESMF3_CLOSE Sold separately (Installed)
8	C/W R5 Insulation (Installed aluminum visible)

No.	Revisions	Date	By/Par

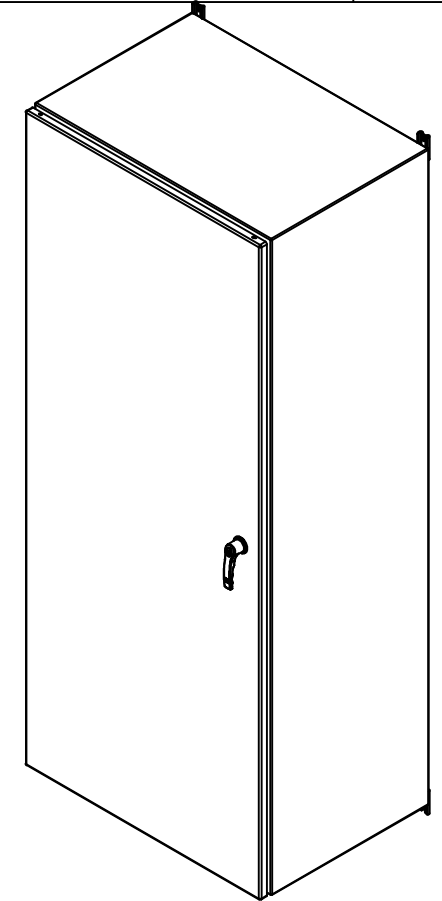

Isometric View



PACKING		
ITEM	QTY	DESCRIPTION
Cardboard sleeve	2	Top and Bottom
Cardboard strip	2	Between back of enclosure and inner panel
Plastic bag	1	To protect cover surface and inside gasket
Cardboard corner	4	To reinforced for the plastic strap tightening
Plastic strap - Black	2	To Squeeze the 2 cardboard sleeve together
Packaging label	3	White label with PN
Plastic strap- Green	2	To secure the enclosure to the wood pallet
Wood Pallet	1	2" deeper and 3" larger than enclosure size

6	STK-Q-00600	2	M12 to M8 Adaptor
1	885SP7230G	0	885SP 72" x 30" Inner Panel Part
1	STK-K-01800	5	5412 ES Accessory Kit
1	5412ESHD723020THC	0	5412ESHD 72" x 30" Cover
1	5412ESHD723020THB	0	5412ESHD 72" x 30" x 20" Body
4	STK-Q-04050-08	0	M6 x 8mm Hexagon Socket Head Machine Screw
Qty	Part Number	Rev	Description
Parts List			

		Flatness Aplatissement Max 3.0mm Projection 	
Tél: (450) 979-4373 Fax: (450) 979-4626 www.exmweb.com		Customer Client Date	
Drawn By Dessiné Par BoxCad: BoxCad		Date 29-Dec-24	
Material Matière 12 Ga Cold Rolled A1008 CS Type B (2.5mm)			
Color Couleur Asa-61 Grey		Finish Fini Smooth	
Description 5412ESHD 72" x 30" x 20" Assembly			Detail Rev.
Part Number Numéro Pièce 5412ESHD723020TH		Rev. 0	2 16

This drawing is confidential and must not be reproduced or used without the consent of EXM

Ce dessin est confidentiel et ne doit pas être reproduit ou utilisé sans le consentement de EXM

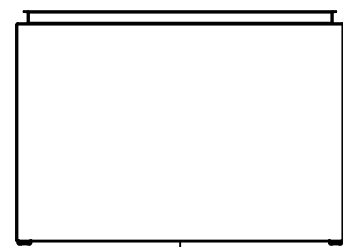

TOP

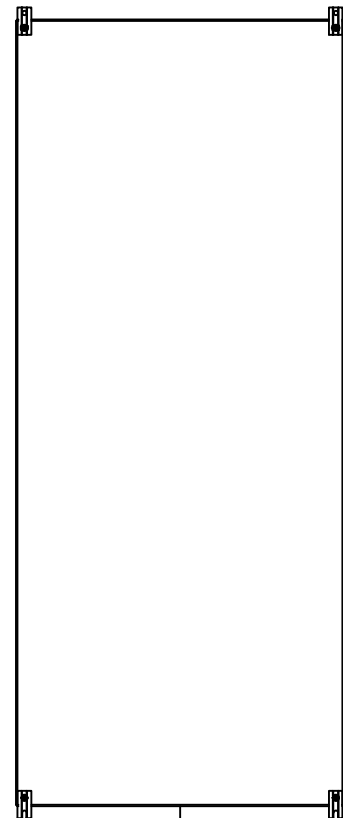

BACK

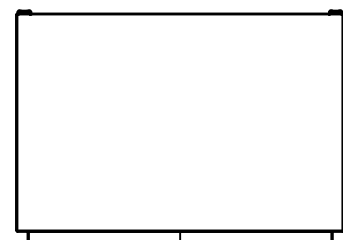

BOTTOM

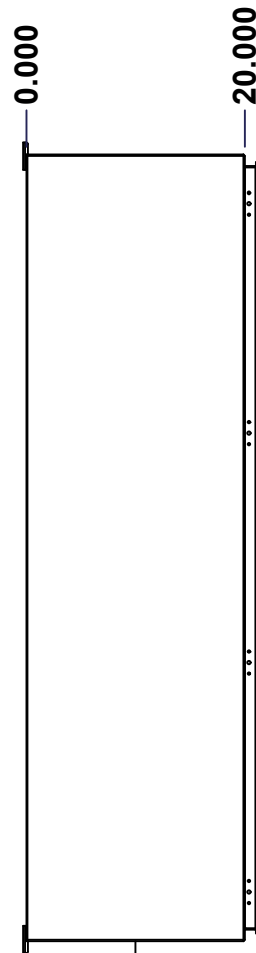

LEFT

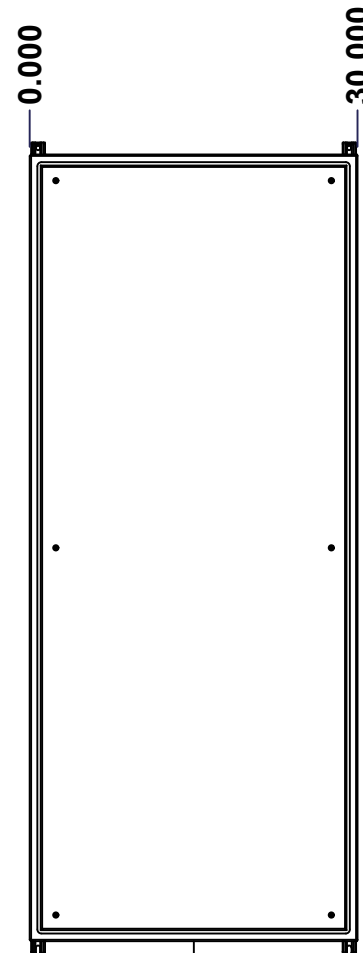

FRONT

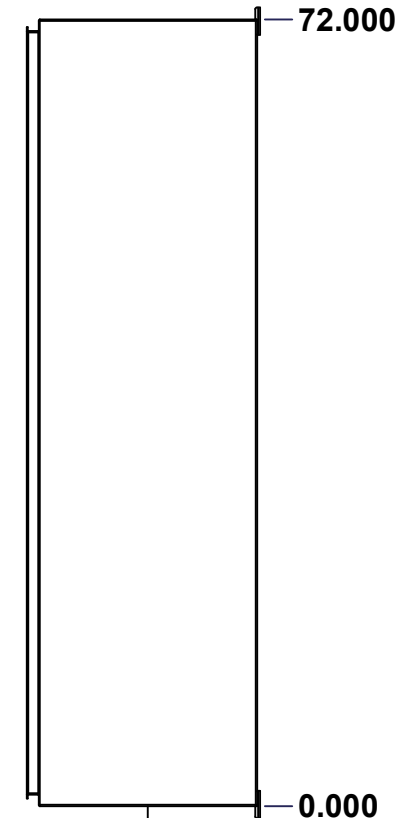

RIGHT

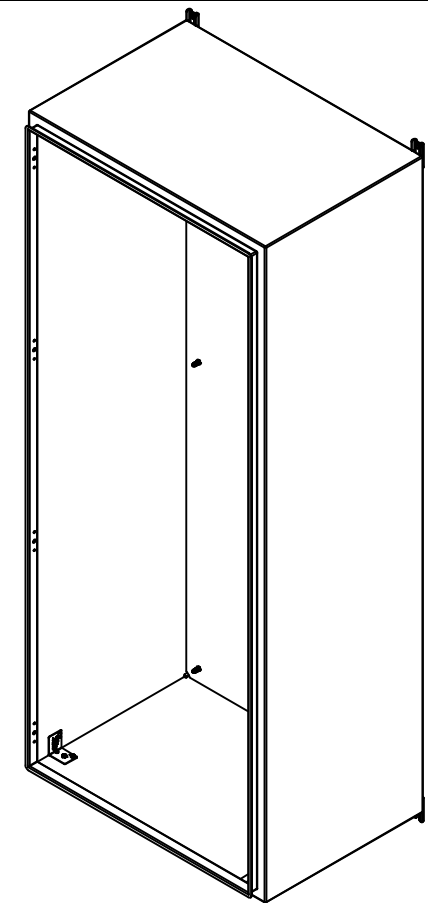

Isometric View

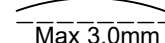
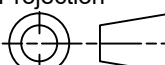

No.	Revisions	Date	By/Par

 Tél: (450) 979-4373 Fax: (450) 979-4626 www.exmweb.com		Flatness Aplatissement  Max 3.0mm
Projection 		Date 29-Dec-24
Customer Client	Date	
Drawn By Dessiné Par	BoxCad: BoxCad	Date 29-Dec-24
Material Matière	12 Ga Cold Rolled A1008 CS Type B (2.5mm)	
Color Couleur	Asa-61 Grey	Finish Fini Smooth
Description	Detail Rev.	
5412ESHD 72" x 30" x 20" Body		
Part Number Numéro Pièce	Rev. 0	3 / 16
5412ESHD723020THB		

SEE BILL OF MATERIAL ON LAST PAGE

This drawing is confidential and must not be reproduced or used without the consent of EXM

Ce dessin est confidentiel et ne doit pas être reproduit ou utilisé sans le consentement de EXM

STANDARD FEATURES ARE NOT LISTED IN THIS HOLE TABLE			
HOLE TABLE - TOP VIEW (CUSTOM FEATURE ONLY)			
CUT-OUT	XDIM	YDIM	DESCRIPTION
1	2.000	17.500	INSUL. STUD M6 x 18mm (Inside)
2	28.000	17.500	INSUL. STUD M6 x 18mm (Inside)

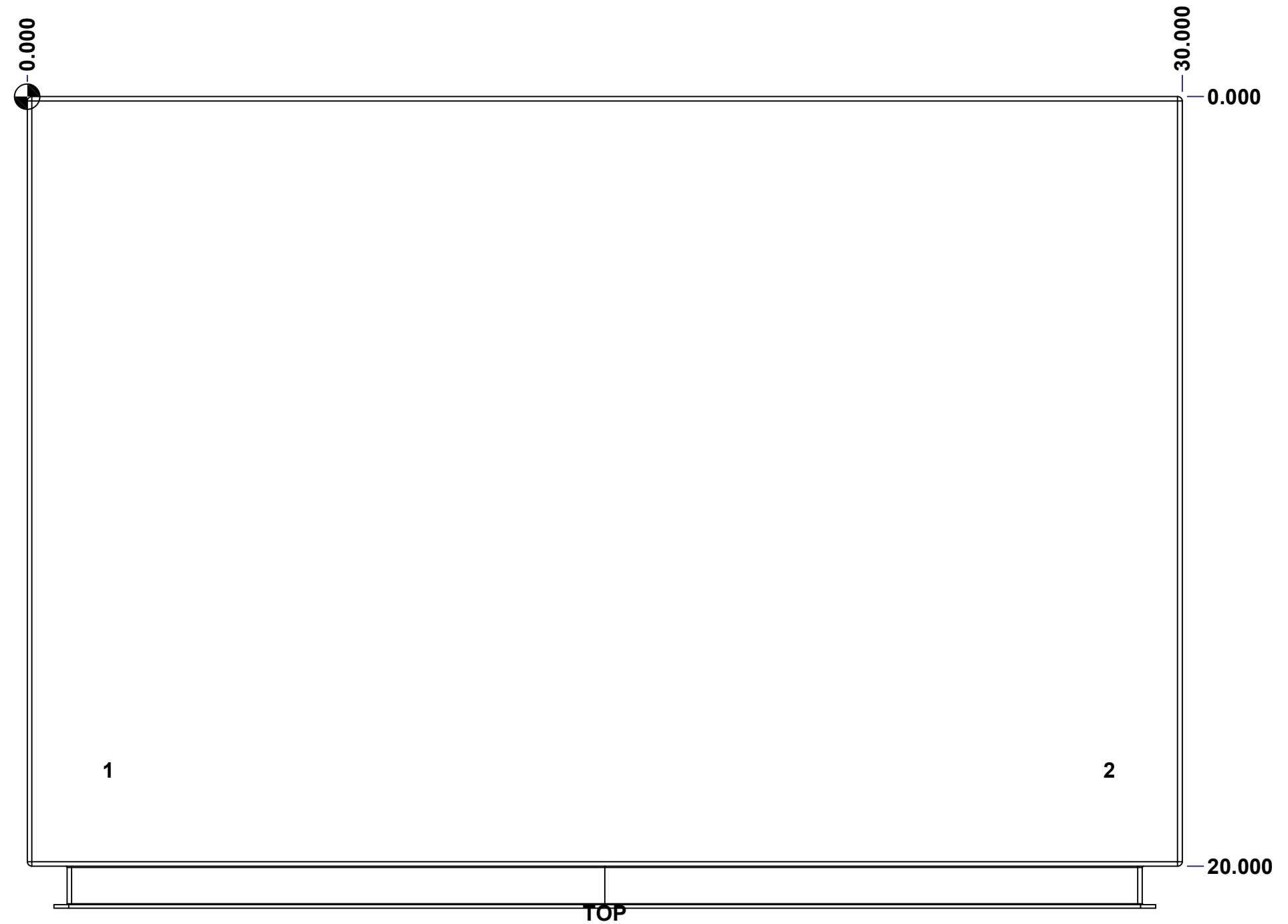

	Description	Status	
	5412ESHD 72" x 30" x 20" Body	(NULL)	
	Part Number Numéro Pièce	Rev.	4
	5412ESHD723020THB	0	16

This drawing is confidential and must not be reproduced or used without the consent of EXM

Ce dessin est confidentiel et ne doit pas être reproduit ou utilisé sans le consentement de EXM

STANDARD FEATURES ARE NOT LISTED IN THIS HOLE TABLE			
HOLE TABLE - BOTTOM VIEW (CUSTOM FEATURE ONLY)			
CUT-OUT	XDIM	YDIM	DESCRIPTION
1	2.000	17.500	INSUL. STUD M6 x 18mm (Inside)
2	28.000	17.500	INSUL. STUD M6 x 18mm (Inside)

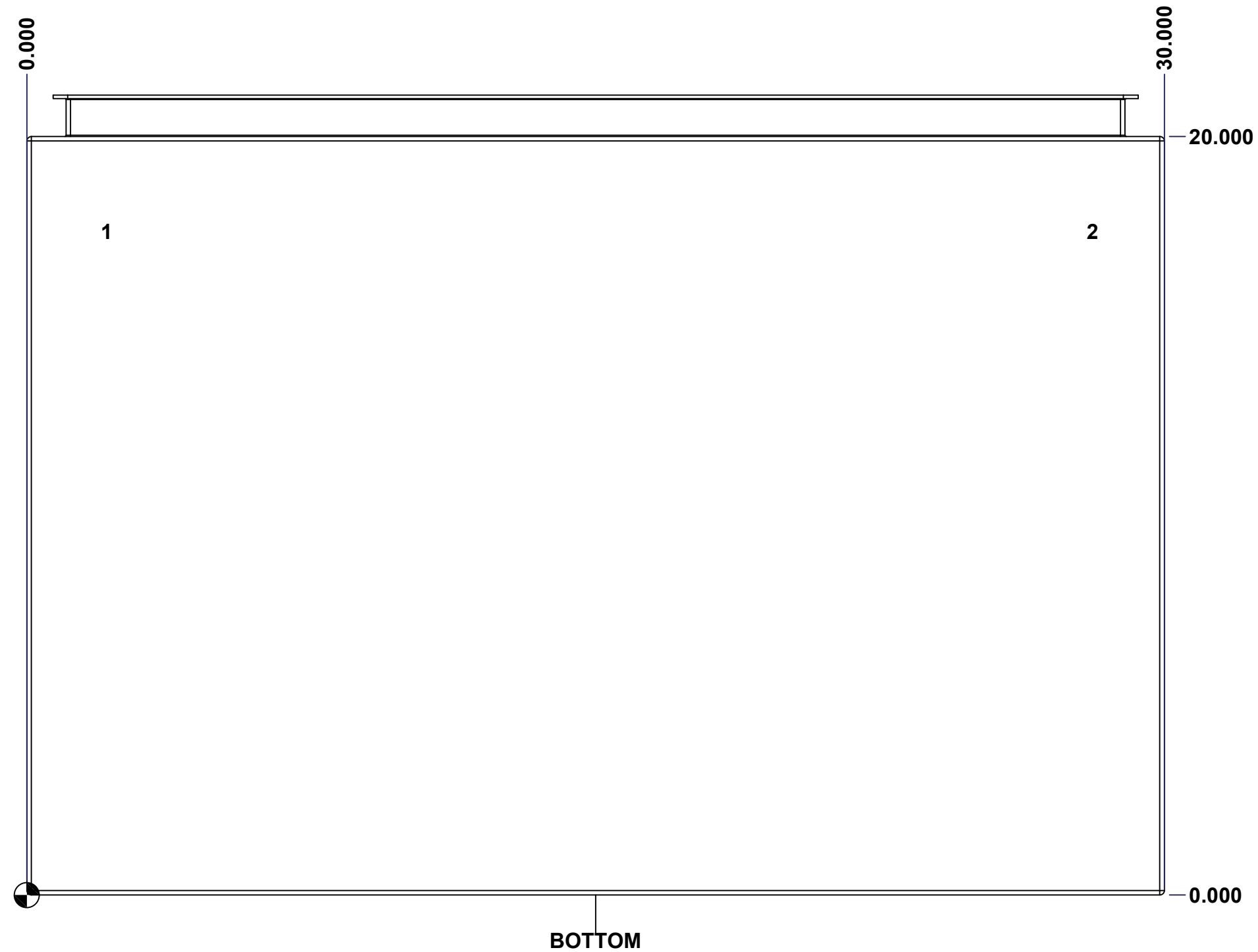

	Description	Status
	5412ESHD 72" x 30" x 20" Body	(NULL)
	Part Number Numéro Pièce	Rev.
	5412ESHD723020THB	0 / 5
		16

This drawing is confidential and must not be reproduced or used without the consent of EXM

Ce dessin est confidentiel et ne doit pas être reproduit ou utilisé sans le consentement de EXM

STANDARD FEATURES ARE NOT LISTED IN THIS HOLE TABLE

HOLE TABLE - BACK VIEW (CUSTOM FEATURE ONLY)

CUT-OUT	XDIM	YDIM	DESCRIPTION
1	2.375	2.375	IP STUD M8 x 35mm (Inside)
2	2.375	69.625	IP STUD M8 x 35mm (Inside)
3	27.625	69.625	IP STUD M8 x 35mm (Inside)
4	27.625	2.375	IP STUD M8 x 35mm (Inside)
5	2.375	36.000	IP STUD M8 x 35mm (Inside)
6	27.625	36.000	IP STUD M8 x 35mm (Inside)

7	29.250	0.000	FOOT 885 ESMF3_OPEN
8	0.750	0.000	FOOT 885 ESMF3_OPEN
9	29.250	72.000	FOOT 885 ESMF3_CLOSE
10	0.750	72.000	FOOT 885 ESMF3_CLOSE

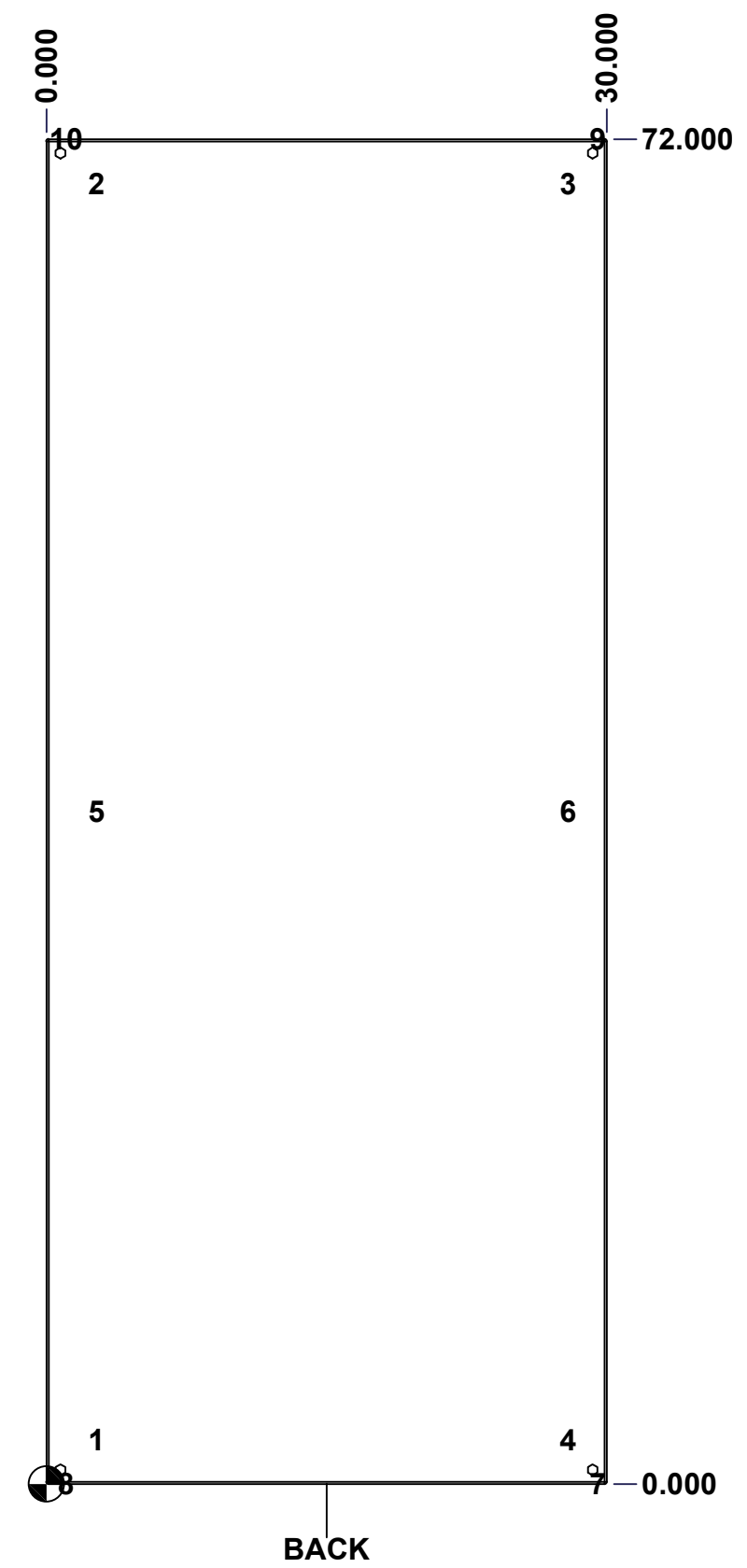

	Description	Status
	5412ESHD 72" x 30" x 20" Body	(NULL)
	Part Number Numéro Pièce	Rev.
	5412ESHD723020THB	0 / 6
		16

This drawing is confidential and must not be reproduced or used without the consent of EXM

Ce dessin est confidentiel et ne doit pas être reproduit ou utilisé sans le consentement de EXM

No.	Revisions	Date	By/Par

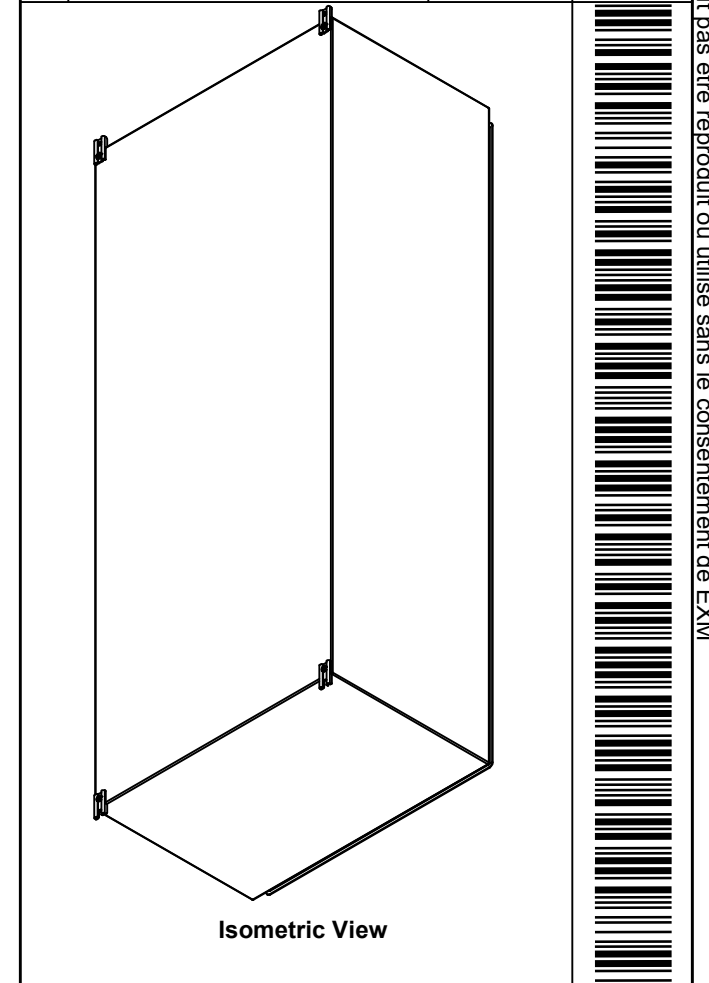

Isometric View

1	885 ESMF3	0	885 ESMF3 Mounting Foot Kit
4	RIVET_NUT_M10_FH_CE	0	Rivet Nut M10 (Low Profile Close End)
1	STK-K-70554	3	5412 ESTH Accessory Kit
1	5412ESHD723020THI-RS	0	5412ESHD 72" x 30" Right Insulation
1	5412ESHD723020THI-LS	0	5412ESHD 72" x 30" Left Insulation
1	5412ESHD723020THI-BT	0	5412ESHD 72" x 30" Bottom Insulation
1	5412ESHD723020THI-TP	0	5412ESHD 72" x 30" Top Insulation
1	5412ESHD723020THI-B	0	5412ESHD 72" x 30" Back Insulation
4	STK-Q-16055	1	M6 x 18mm Stud (No Paint Cap Required)
1	STK-P-02400S	0	Powder Paint (Asa-61 Grey / Smooth)
6	STK-Q-16005	0	Stud M8 x 35mm Steel
1	5412ESHD723020THB-P	0	5412ESHD 72" x 30" x 20" Body Part
Qty	Part Number	Rev	Description
Parts List			

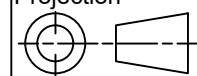
 Tél: (450) 979-4373 Fax: (450) 979-4626 www.exmweb.com		Flatness Aplatissement Max 3.0mm
Projection 		Customer Client
Drawn By Dessiné Par BoxCad: BoxCad		Date 29-Dec-24
Material Matière 12 Ga Cold Rolled A1008 CS Type B (2.5mm)		
Color Couleur Asa-61 Grey	Finish Fini Smooth	
Description 5412ESHD 72" x 30" x 20" Body		Detail Rev.
Part Number Numéro Pièce 5412ESHD723020THB		Rev. 7 0
		16

This drawing is confidential and must not be reproduced or used without the consent of EXM

Ce dessin est confidentiel et ne doit pas être reproduit ou utilisé sans le consentement de EXM

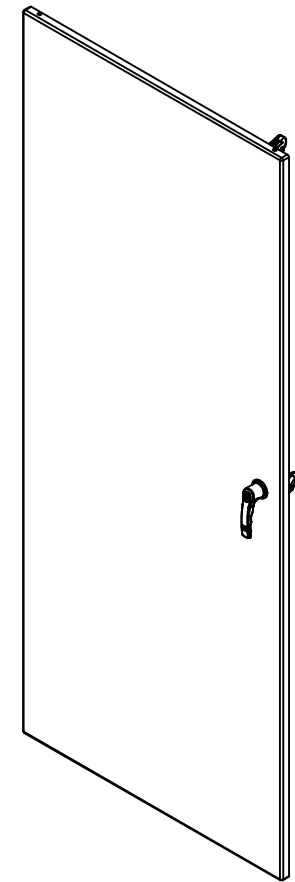
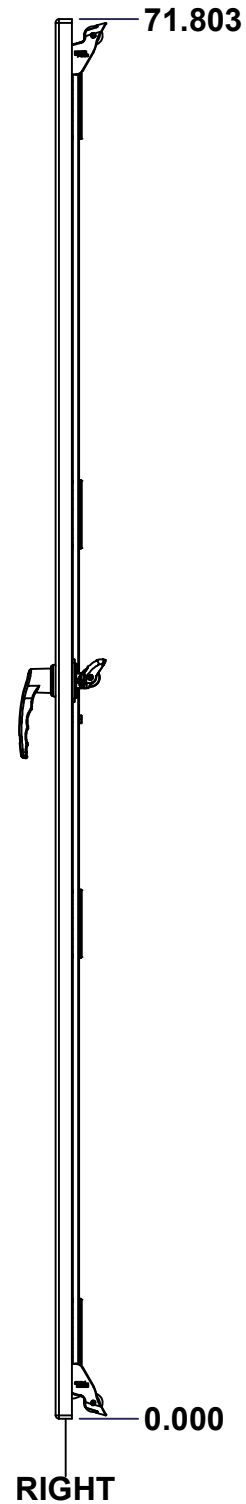
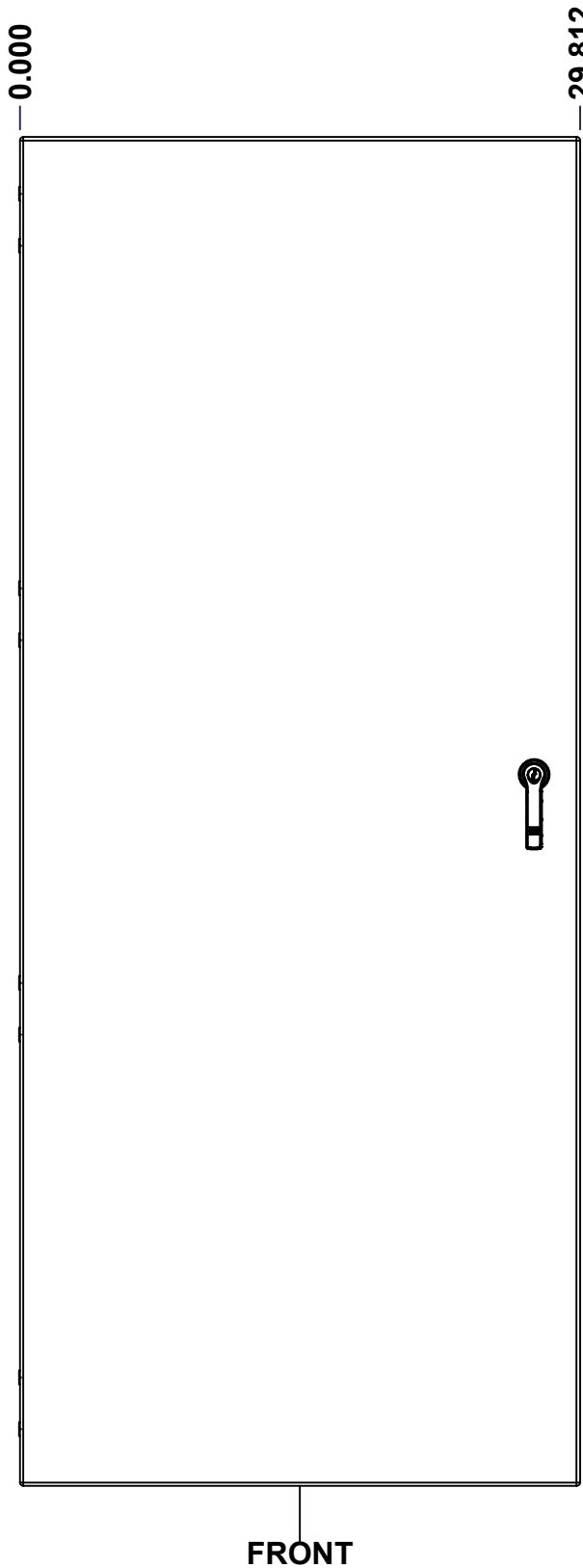
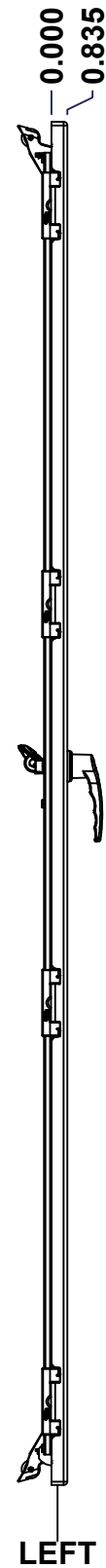
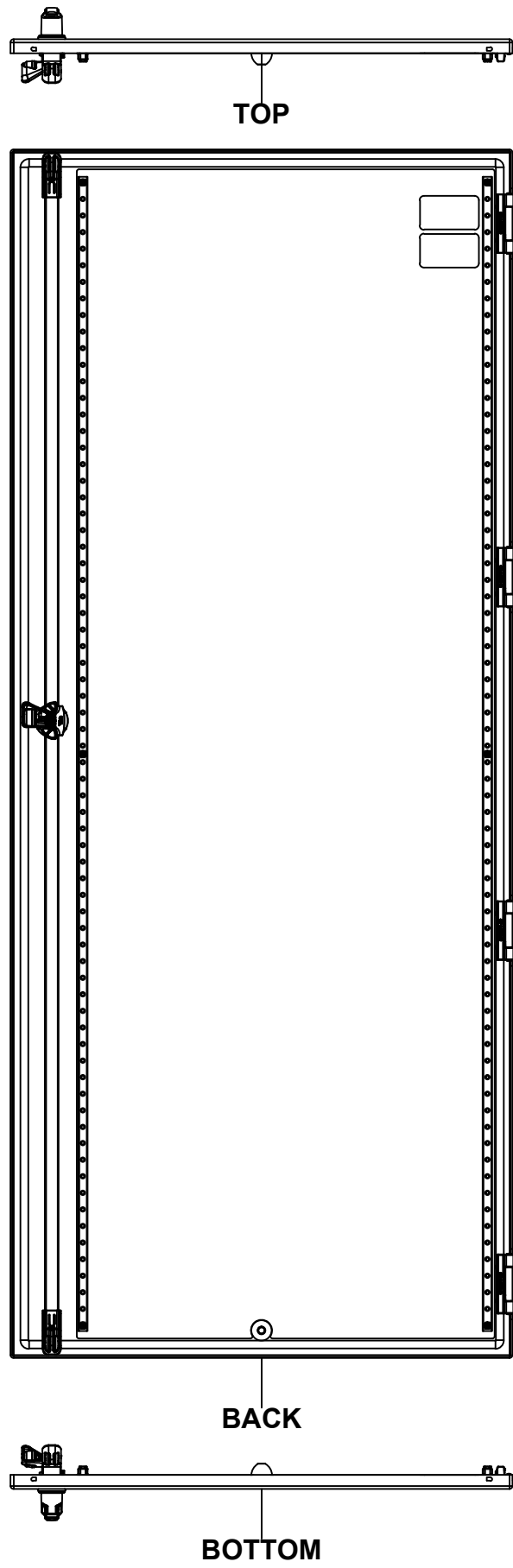

Isometric View

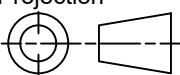

No.	Revisions	Date	By/Par

 Tél: (450) 979-4373 Fax: (450) 979-4626 www.exmweb.com		Flatness Aplatissement Max 3.0mm Projection 
Customer Client		Date
Drawn By Dessiné Par	BoxCad: BoxCad	Date 29-Dec-24
Material Matière	12 Ga Cold Rolled A1008 CS Type B (2.5mm)	
Color Couleur	Asa-61 Grey	Finish Fini Smooth
Description		Detail Rev.
5412ESHD 72" x 30" Cover		
Part Number Numéro Pièce	Rev. 8	16
5412ESHD723020THC		0

SEE BILL OF MATERIAL ON LAST PAGE

This drawing is confidential and must not be reproduced or used without the consent of EXM

Ce dessin est confidentiel et ne doit pas être reproduit ou utilisé sans le consentement de EXM

STANDARD FEATURES ARE NOT LISTED IN THIS HOLE TABLE

HOLE TABLE - FRONT VIEW (CUSTOM FEATURE ONLY)

CUT-OUT	XDIM	YDIM	DESCRIPTION
1	1.486	1.945	STUD M6 x 18mm (Inside)
2	1.486	69.858	STUD M6 x 18mm (Inside)
3	25.512	69.858	STUD M6 x 18mm (Inside)
4	25.512	1.945	STUD M6 x 18mm (Inside)
5	1.486	35.902	STUD M6 x 18mm (Inside)
6	25.512	35.902	STUD M6 x 18mm (Inside)
7	27.366	65.803	LARGE CBAR GUIDE (Inside)
8	27.366	6.000	LARGE CBAR GUIDE (Inside)
9	14.906	1.650	STUD M6 x 18mm (Inside)

10	27.366	37.870	HANDLE 885 ESL2A @ 0.0°

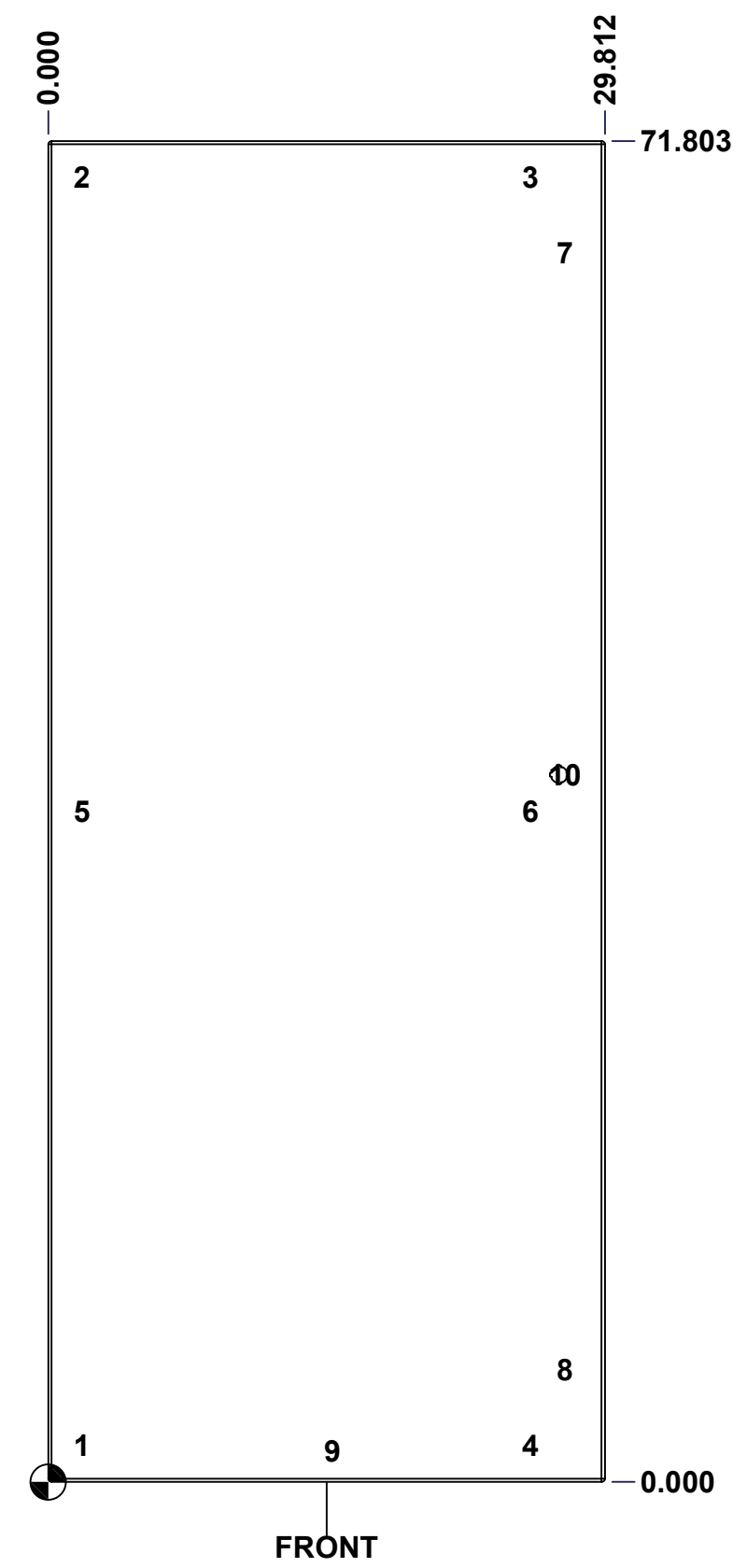

	Description	Status
	5412ESHD 72" x 30" Cover	(NULL)
	Part Number Numéro Pièce	Rev.
	5412ESHD723020THC	0 / 9
		16

This drawing is confidential and must not be reproduced or used without the consent of EXM

Ce dessin est confidentiel et ne doit pas être reproduit ou utilisé sans le consentement de EXM

No.	Revisions	Date	By/Par

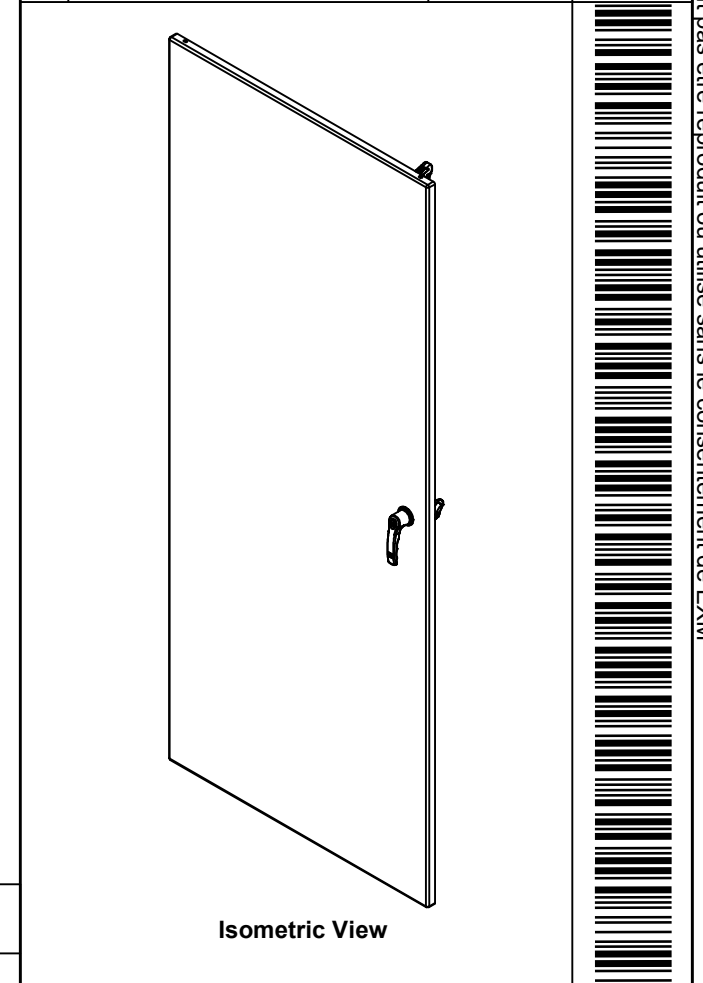

1	5412ESHD723020THCB_D-P	0	5412ESHD 72" Lower Closing Bar (Cam)
1	5412ESHD723020THCB_U-P	0	5412ESHD 72" Upper Closing Bar (Cam)
1	STK-A-50538	3	9500 Handle Cam Assembly (Right Side, Grip 36mm)
1	STK-Q-90051	3	5412 ES - Handle Cam Spacer
1	885 ESL2A	4	5412 ES Key Lock L-Handle (3 Pts)
2	STK-S-00100	0	3.5" x 2" Silver Milar Flexcon Sticker
6	STK-Q-07250	2	M6 x 16mm Collar Nut
2	STK-Q-46020-72	5	5412 ES Vertical Door Stiffener 72"
1	5412ESHD723020THI-C	0	5412ESHD 72" x 30" Cover Insulation
1	STK-P-02400S	0	Powder Paint (Asa-61 Grey / Smooth)
1	STK-Q-46515	3	5412 ES Door Support with Brass Insert
2	STK-Q-16410	0	Guide Stud - Largel (No Paint Cap Required)
7	STK-Q-16055	1	M6 x 18mm Stud (No Paint Cap Required)
1	5412ESHD723020THG	0	5412ESHD 72" x 30" Door Gasket
1	5412ESHD723020THC-P	0	5412ESHD 72" x 30" Cover Part
2	STK-A-90025	0	9500 - Cabinet Closing Bar End (Large)
4	STK-K-09860	7	Cabinet Hinge with Captive Pins
QTY	Part Number	Rev	Description
Parts List			

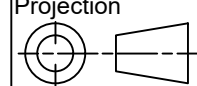
 Tél: (450) 979-4373 Fax: (450) 979-4626 www.exmweb.com		Flatness Aplatissement Max 3.0mm Projection 
Customer Client	Date	Date
Drawn By Dessiné Par	BoxCad: BoxCad	Date 29-Dec-24
Material Matière	12 Ga Cold Rolled A1008 CS Type B (2.5mm)	
Color Couleur	Asa-61 Grey	Finish Fini Smooth
Description	Detail Rev.	
5412ESHD 72" x 30" Cover		
Part Number Numéro Pièce	Rev.	10
5412ESHD723020THC	0	16

This drawing is confidential and must not be reproduced or used without the consent of EXM

Ce dessin est confidentiel et ne doit pas être reproduit ou utilisé sans le consentement de EXM

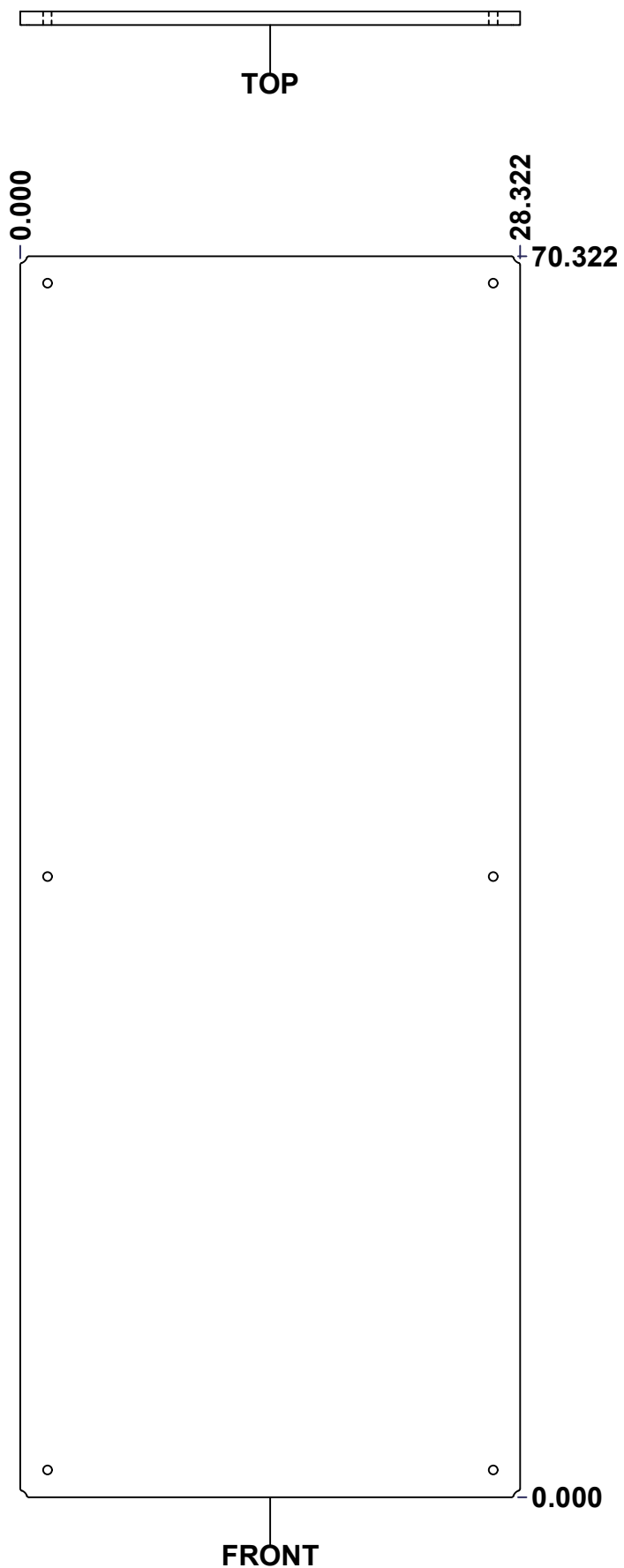

No.	Revisions	Date	By/Par

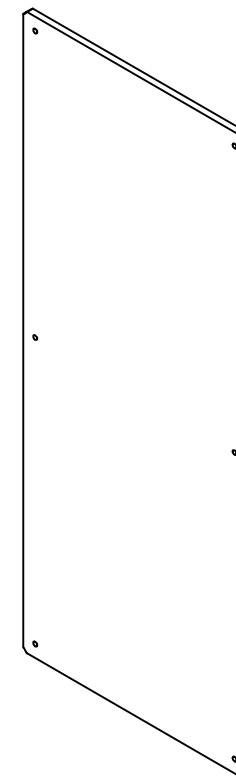

Isometric View

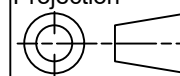

 Tél: (450) 979-4373 Fax: (450) 979-4626 www.exmweb.com	Flatness Aplatissement	Max 3.0mm
	Projection	
Customer Client	Date	
Drawn By Dessiné Par	BoxCad: Patrick Deschenes	Date 23-Jan-07
Material Matière	Polyisocyanurate	
Color Couleur	Aluminum	Finish Fini N/A
Description	Detail Rev.	
5412ESHD 72" x 30" Back Insulation		
Part Number Numéro Pièce	Rev.	11
5412ESHD723020THI-B	0	16

SEE BILL OF MATERIAL ON LAST PAGE

This drawing is confidential and must not be reproduced or used without the consent of EXM

Ce dessin est confidentiel et ne doit pas être reproduit ou utilisé sans le consentement de EXM

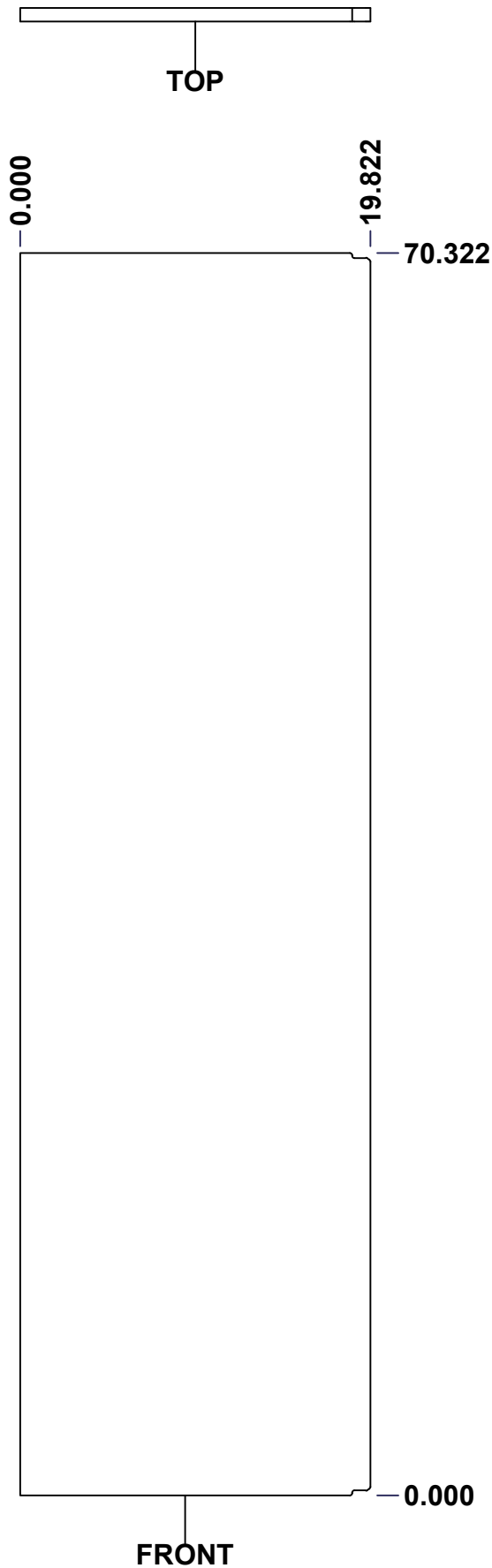

No.	Revisions	Date	By/Par

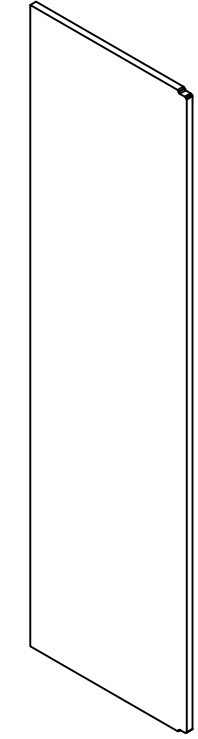

Isometric View

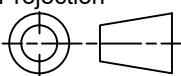

 Tél: (450) 979-4373 Fax: (450) 979-4626 www.exmweb.com		Flatness Aplatissement Max 3.0mm
Projection 		Date 23-Jan-07
Customer Client	Date	
Drawn By / Dessiné Par: BoxCad: Patrick Deschenes	Date: 23-Jan-07	
Material / Matière: Polyisocyanurate	Date	
Color / Couleur: Aluminum	Finish / Fini: N/A	Date
Description: 5412ESHD 72" x 30" Left Insulation		Detail Rev.
Part Number / Numéro Pièce: 5412ESHD723020TH-LS	Rev. 0	12 / 16

SEE BILL OF MATERIAL ON LAST PAGE

This drawing is confidential and must not be reproduced or used without the consent of EXM

Ce dessin est confidentiel et ne doit pas être reproduit ou utilisé sans le consentement de EXM

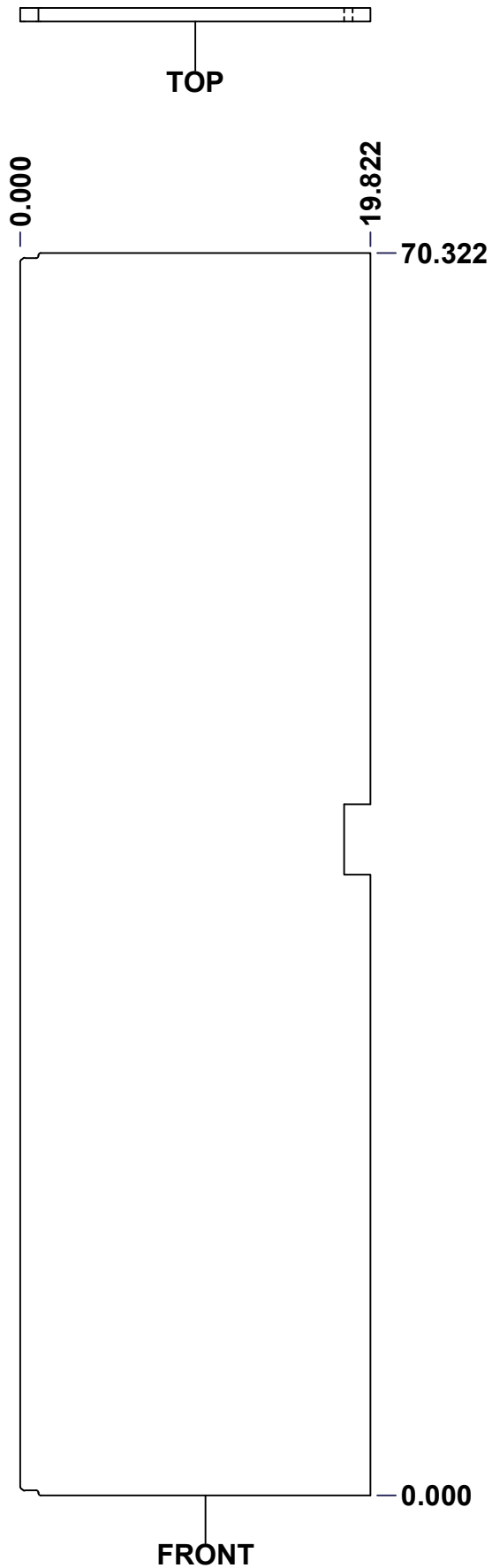

No.	Revisions	Date	By/Par

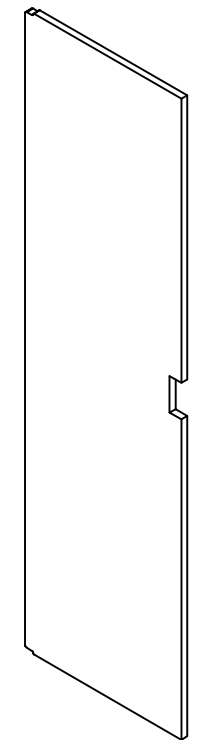

Isometric View

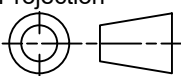

 Tél: (450) 979-4373 Fax: (450) 979-4626 www.exmweb.com		Flatness Aplatissement Max 3.0mm
Projection 		Date 23-Jan-07
Customer Client	Date	
Drawn By / Dessiné Par: BoxCad: Patrick Deschenes	Date: 23-Jan-07	
Material / Matière: Polyisocyanurate	Date	
Color / Couleur: Aluminum	Finish / Fini: N/A	Date
Description: 5412ESHD 72" x 30" Right Insulation		Detail Rev.
Part Number / Numéro Pièce: 5412ESHD723020TH-RS	Rev. 0	13 / 16

SEE BILL OF MATERIAL ON LAST PAGE

This drawing is confidential and must not be reproduced or used without the consent of EXM

Ce dessin est confidentiel et ne doit pas être reproduit ou utilisé sans le consentement de EXM

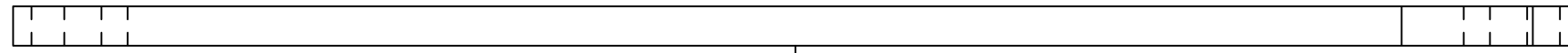

TOP



FRONT

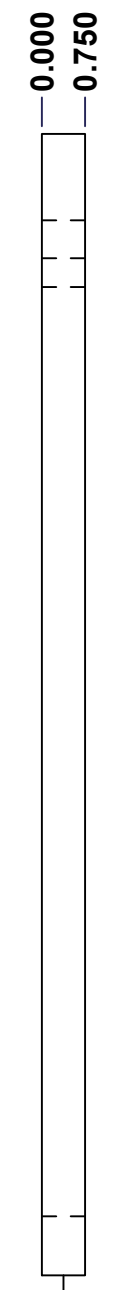

RIGHT

No.	Revisions	Date	By/Par

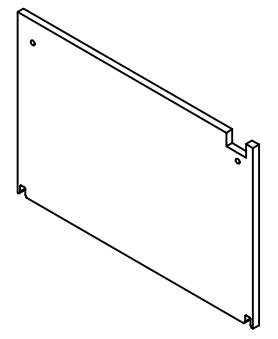

Isometric View



Tél: (450) 979-4373
 Fax: (450) 979-4626
www.exmweb.com

Flatness
Aplatissement
Max 3.0mm
Projection

Customer Client	Date
Drawn By Dessiné Par BoxCad: BoxCad	Date 4/3/2024
Material Matière Polyisocyanurate	
Color Couleur Aluminum	Finish Fini Smooth

Description 5412ESHD 72" x 30"Top Insulation	Detail Rev.
---	-------------

Part Number Numéro Pièce	Rev.	14
5412ESHD723020THI-TP	0	16

SEE BILL OF MATERIAL ON LAST PAGE

This drawing is confidential and must not be reproduced or used without the consent of EXM

Ce dessin est confidentiel et ne doit pas être reproduit ou utilisé sans le consentement de EXM

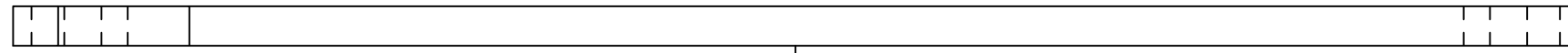

TOP

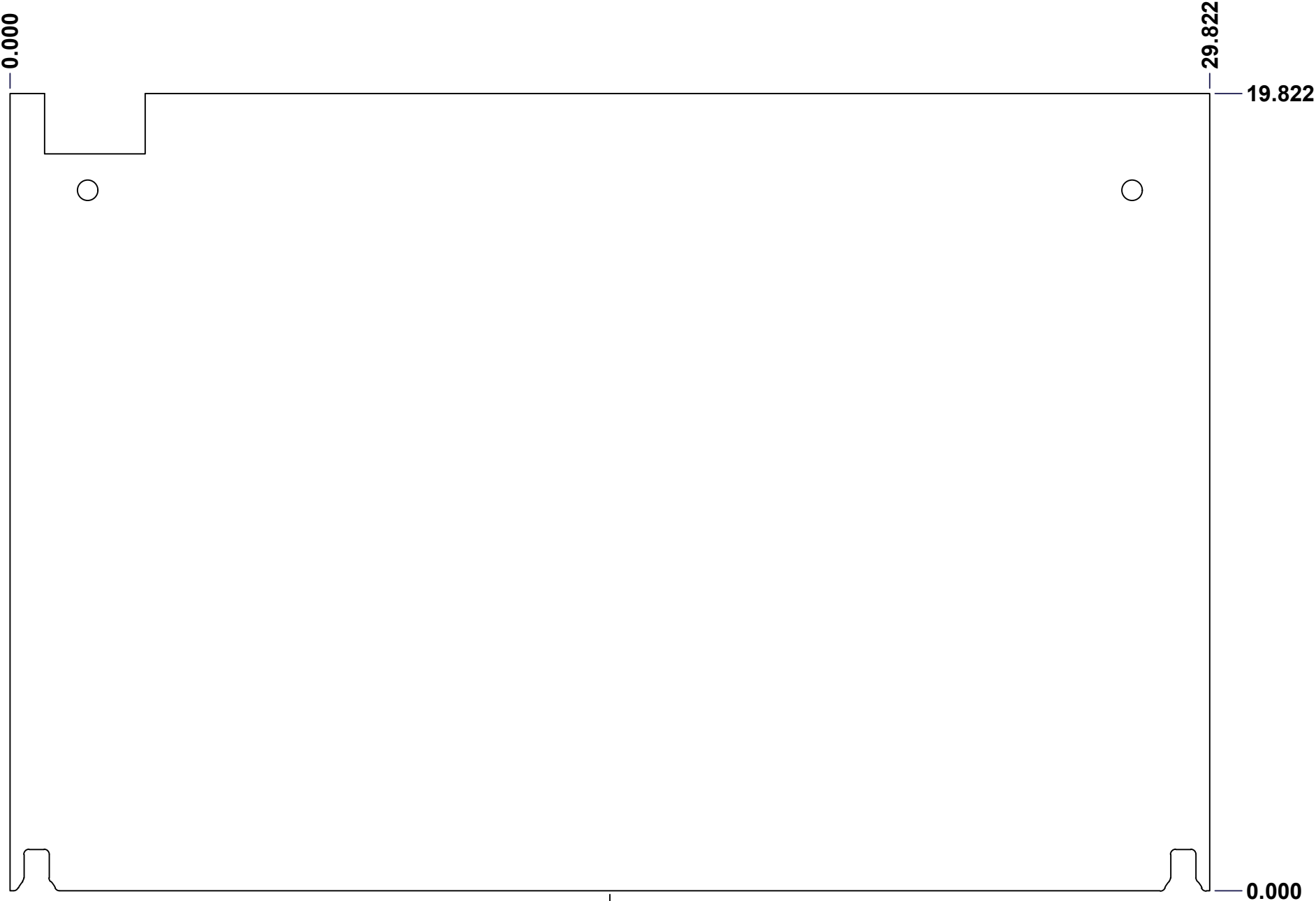

FRONT

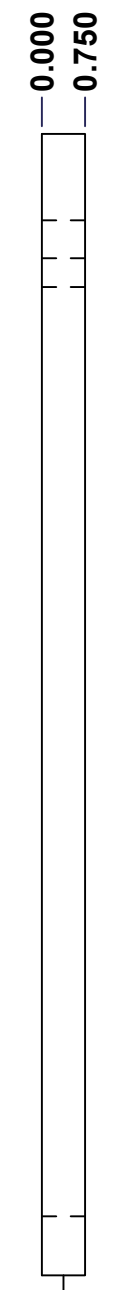

RIGHT

No.	Revisions	Date	By/Par

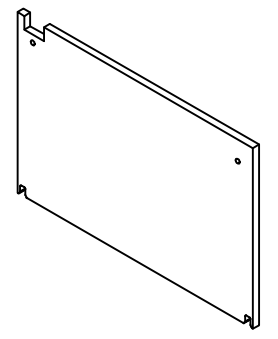

Isometric View



Tél: (450) 979-4373
 Fax: (450) 979-4626
www.exmweb.com

Flatness
Aplatissement
Max 3.0mm
Projection

Customer Client	Date
Drawn By / Dessiné Par: BoxCad: BoxCad	Date: 4/3/2024
Material / Matière: Polyisocyanurate	
Color / Couleur: Aluminum	Finish / Fini: Smooth

Description: 5412ESHD 72" x 30"Bottom Insulation	Detail Rev.
--	-------------

Part Number / Numéro Pièce: 5412ESHD723020THI-BT	Rev. 0	15	16
--	--------	----	----

SEE BILL OF MATERIAL ON LAST PAGE

This drawing is confidential and must not be reproduced or used without the consent of EXM

Ce dessin est confidentiel et ne doit pas être reproduit ou utilisé sans le consentement de EXM

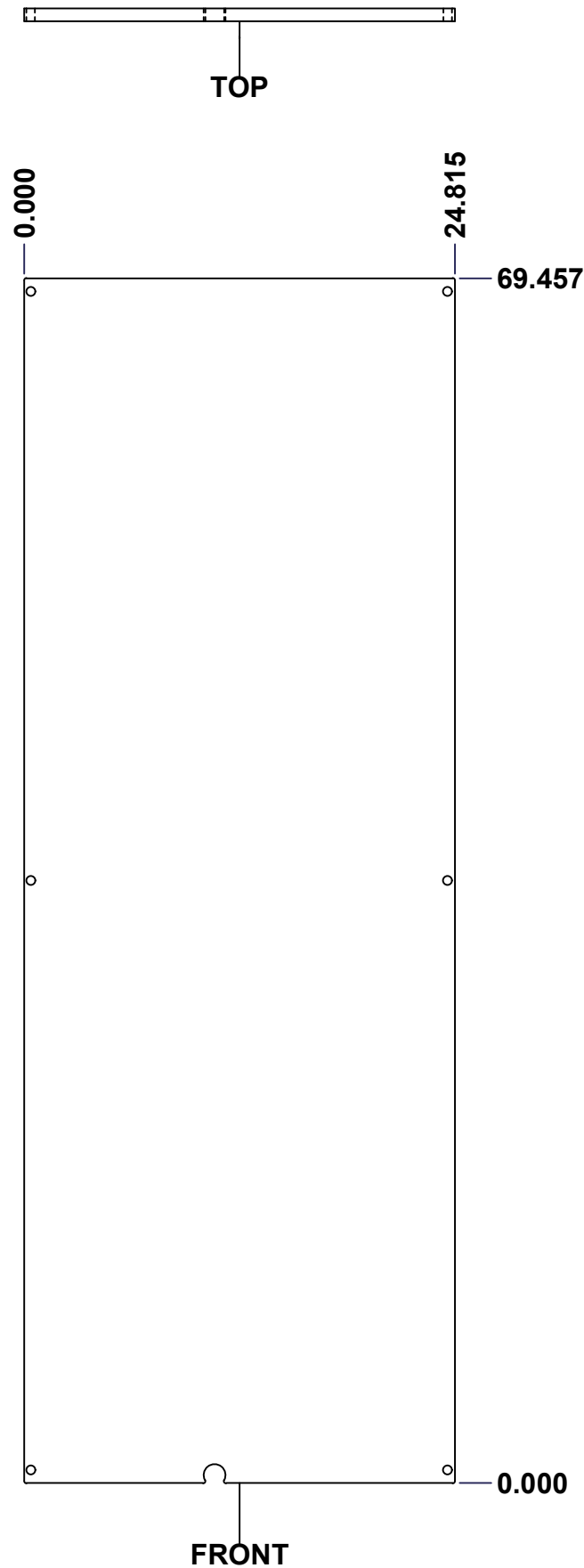

0.000
0.750

No.	Revisions	Date	By/Par

Isometric View

<p>Tél: (450) 979-4373 Fax: (450) 979-4626 www.exmweb.com</p>		Flatness Aplatissement Max 3.0mm Projection
Customer Client	Date	
Drawn By Dessiné Par	BoxCad: Patrick Deschenes	Date 23-Jan-07
Material Matière	Polyisocyanurate	
Color Couleur	Aluminum	Finish Fini N/A
Description 5412ESHD 72" x 30" Cover Insulation		Detail Rev.
Part Number Numéro Pièce	Rev. 0	16 / 16

SEE BILL OF MATERIAL ON LAST PAGE

5412ESHD723020THI-C

This drawing is confidential and must not be reproduced or used without the consent of EXM

Ce dessin est confidentiel et ne doit pas être reproduit ou utilisé sans le consentement de EXM

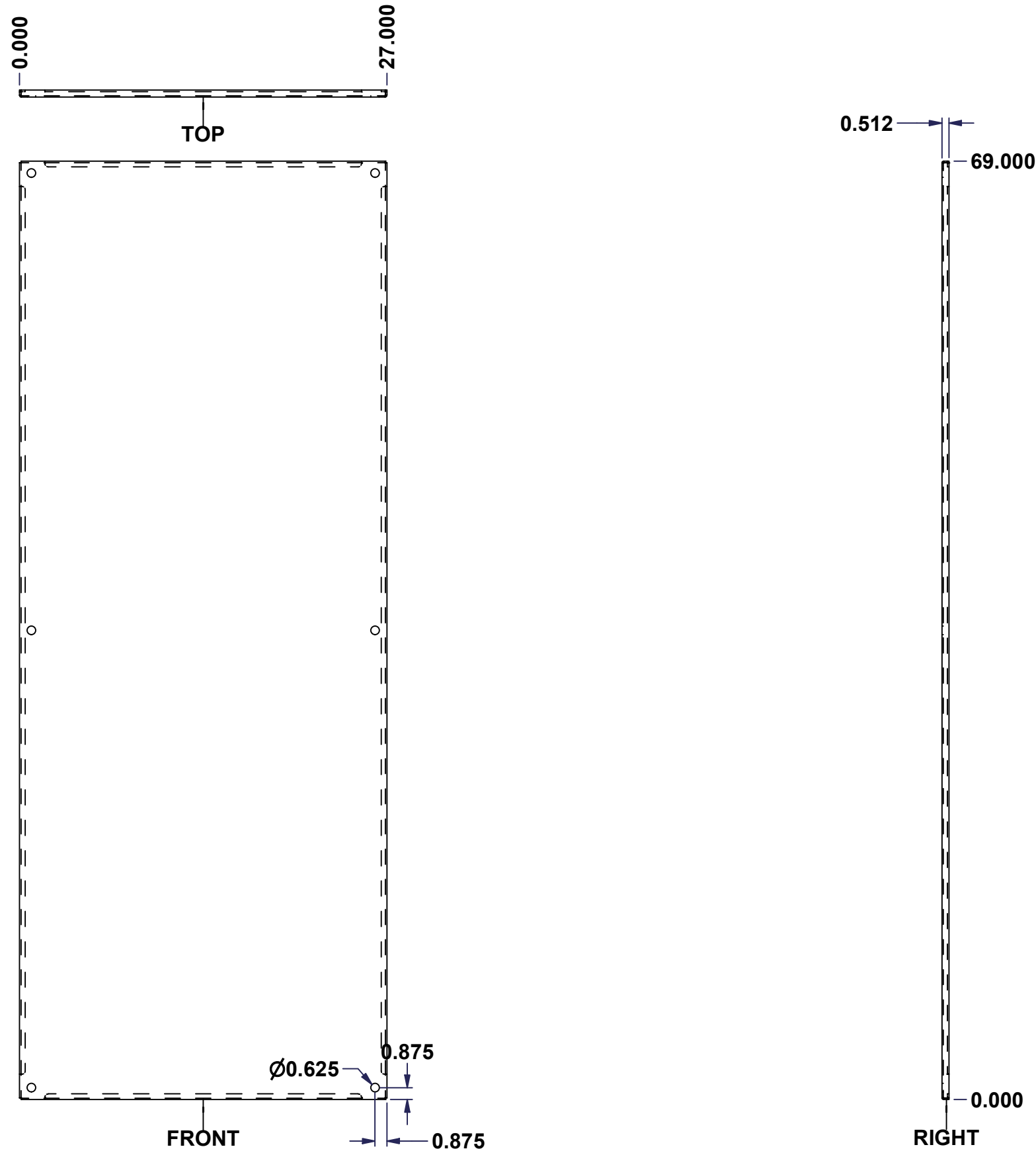

No.	Revisions	Date	By/Par

Isometric View

		Flatness Aplatissement Max 3.0mm	
Tél: (450) 979-4373 Fax: (450) 979-4626 www.exmweb.com		Projection 	
Customer Client		Date	
Drawn By / Dessiné Par: BoxCad: nickz		Date: 01/03/2017	
Material / Matière: 12 Ga Galvanized (2.5mm)			
Color / Couleur: See Part List		Finish / Fini: See Part List	
Description: 885SP 72" x 30" Inner Panel Part			Detail Rev.
Part Number / Numéro Pièce: 885SP7230G			Rev. 1

Qty	Part Number	Rev	Description	Material	Color	Finish
1	885SP7230G-P	0	885SP 72" x 30" Inner Panel Part	12 Ga Galvanized (2.5mm)	Unpainted	Galvanized

Parts List