

This drawing is confidential and must not be reproduced or used without the consent of EXM

Ce dessin est confidentiel et ne doit pas être reproduit ou utilisé sans le consentement de EXM

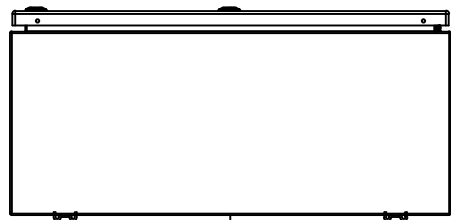

TOP

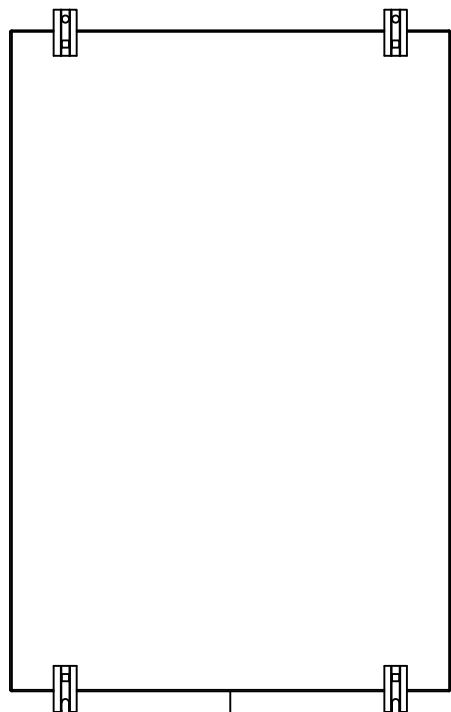

BACK

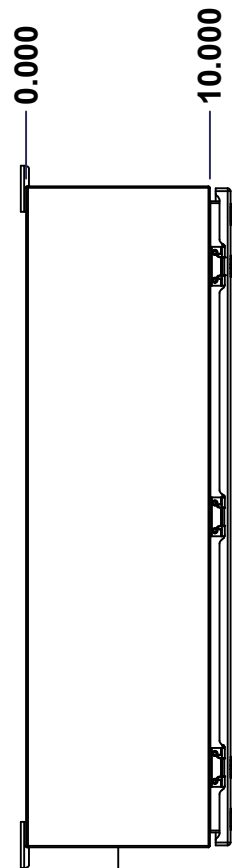

LEFT

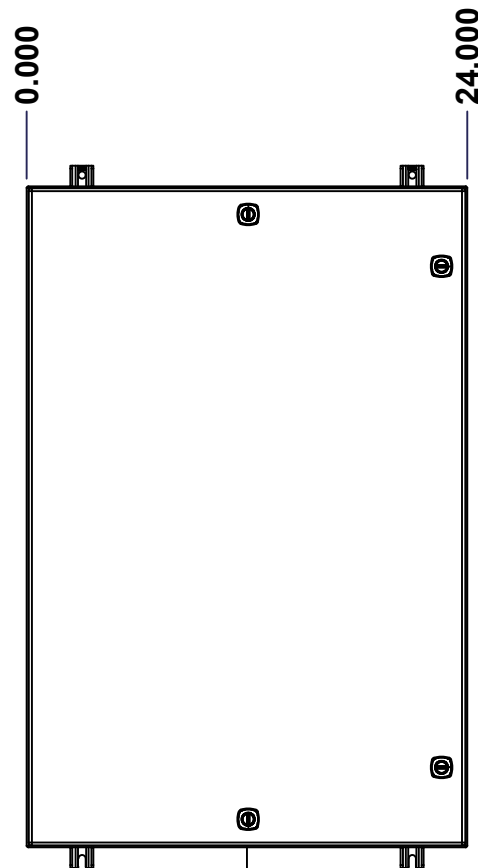

FRONT

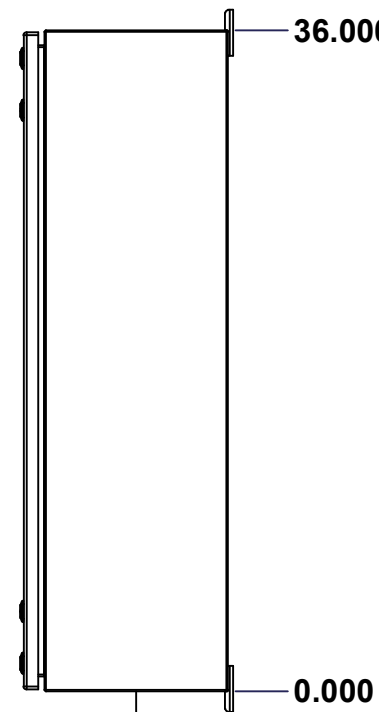

RIGHT

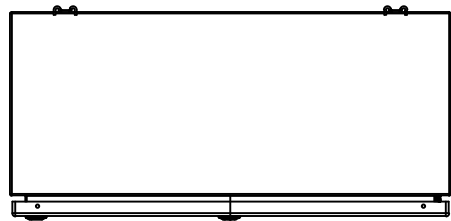

BOTTOM

No.	Revisions	Date	By/Par

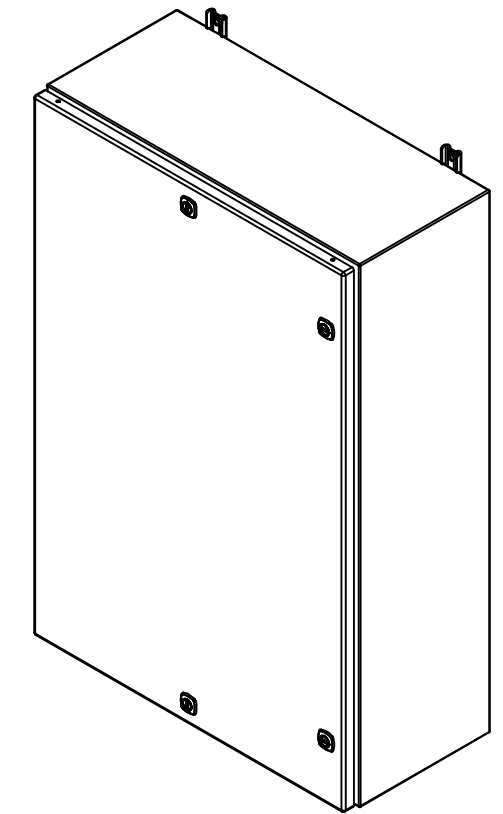

Isometric View

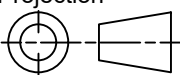

 Tél: (450) 979-4373 Fax: (450) 979-4626 www.exmweb.com		Flatness Aplatissement Max 3.0mm Projection 
Customer Client	Date	
Drawn By Dessiné Par	BoxCad: BoxCad	Date 27-Feb-25
Material Matière	16 Ga Cold Rolled A1008 CS Type B (1.4mm)	
Color Couleur	Asa-61 Grey	Finish Fini Smooth
Description 5412ESPR 36" x 24" x 10" Assembly		Detail Rev.
Part Number Numéro Pièce	5412ESPR362410TH	Rev. 1 0

SEE BILL OF MATERIAL ON LAST PAGE

This drawing is confidential and must not be reproduced or used without the consent of EXM

Ce dessin est confidentiel et ne doit pas être reproduit ou utilisé sans le consentement de EXM

NOTE	
ITEM	DESCRIPTION
1	NEMA 4, 12 Enclosure (IP66)
2	C/W Standard ground studs on box and cover
3	C/W Standard door stiffener
4	C/W Standard inner panel (Included)
5	C/W Standard inner panel mounting studs
6	C/W R5 Insulation (Installed aluminum visible)

No.	Revisions	Date	By/Par

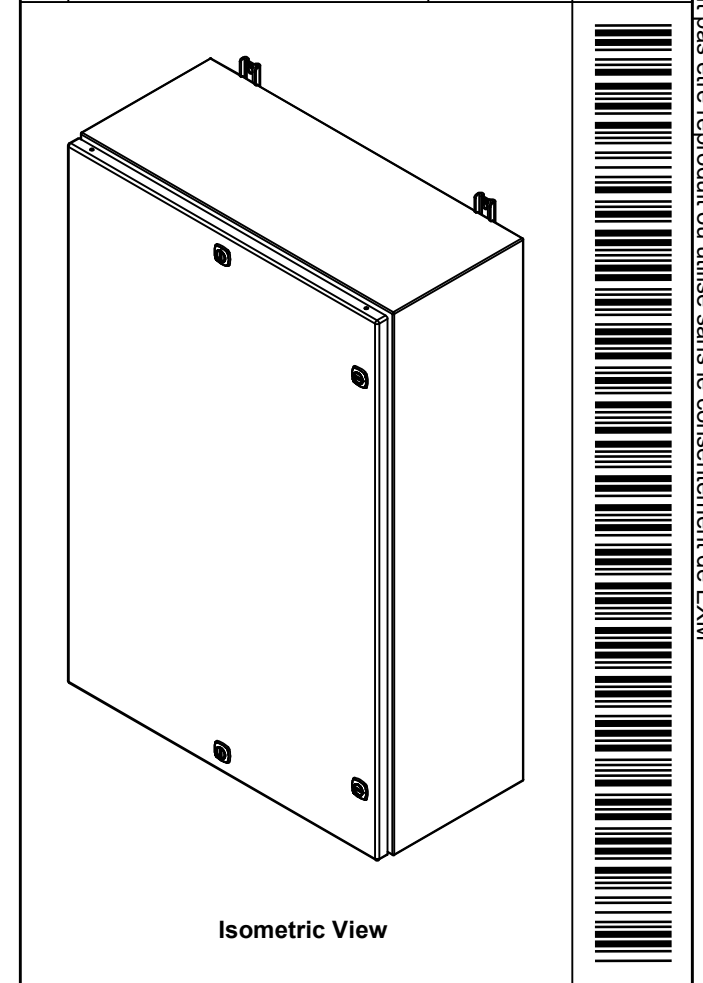

	Tél: (450) 979-4373 Fax: (450) 979-4626 www.exmweb.com	Flatness Aplatissement
		Max 3.0mm
Projection		
Customer Client	Date	
Drawn By Dessiné Par	BoxCad: BoxCad	Date 27-Feb-25
Material Matière	16 Ga Cold Rolled A1008 CS Type B (1.4mm)	

PACKING		
ITEM	QTY	DESCRIPTION
Cardboard sleeve	2	Top and Bottom
Cardboard strip	2	Between back of enclosure and inner panel
Plastic bag	1	To protect cover surface and inside gasket
Plastic strap - Black	2	To Squeeze the 2 cardboard sleeve together
Packaging label	1	White label with product number

Qty	Part Number	Rev	Description
6	STK-Q-00600	2	M12 to M8 Adaptor
1	881 SP3624G	0	881 SP - Inner Panel
1	STK-K-01800	5	5412 ES Accessory Kit
1	5412ESPR362410THC	0	5412ESPR 36" x 24" Cover
1	5412ESPR362410THB	0	5412ESPR 36" x 24" x 10" Body
6	STK-Q-04050-08	0	M6 x 8mm Hexagon Socket Head Machine Screw
Parts List			

Color Couleur	Asa-61 Grey	Finish Fini	Smooth
Description	5412ESPR 36" x 24" x 10" Assembly		Detail Rev.
Part Number Numéro Pièce	5412ESPR362410TH		Rev. 0
			2 / 16

This drawing is confidential and must not be reproduced or used without the consent of EXM

Ce dessin est confidentiel et ne doit pas être reproduit ou utilisé sans le consentement de EXM

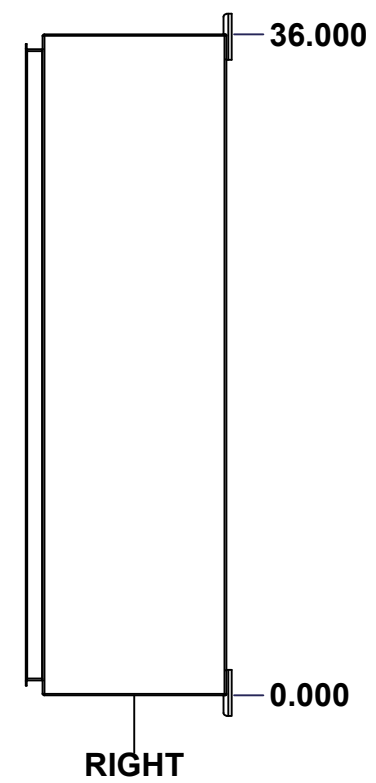
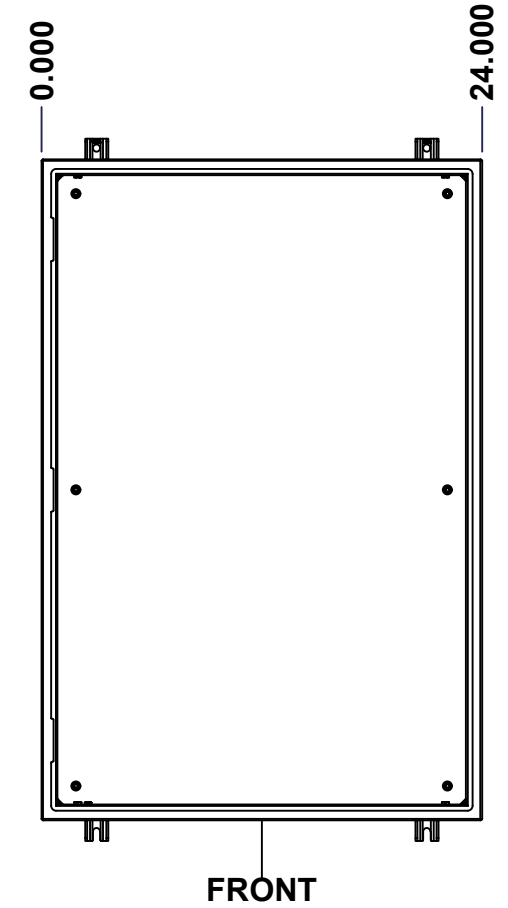
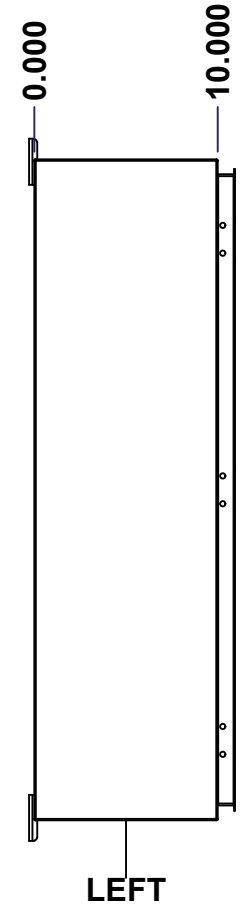
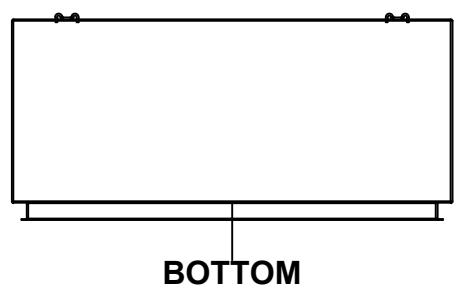
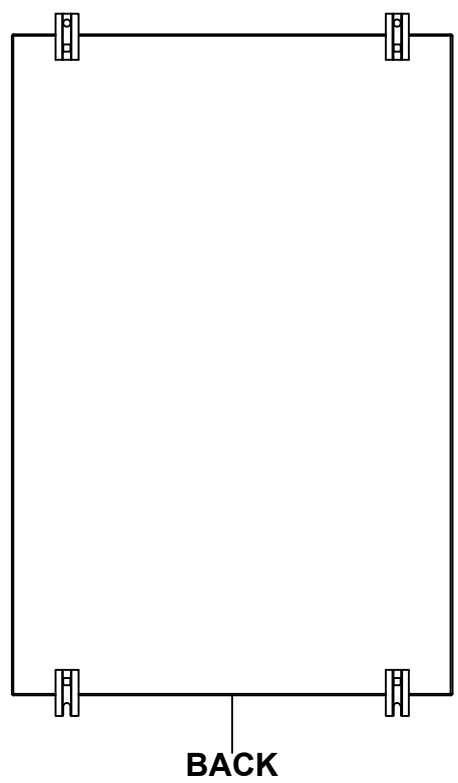
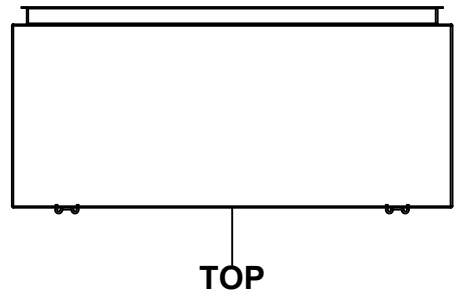

No.	Revisions	Date	By/Par

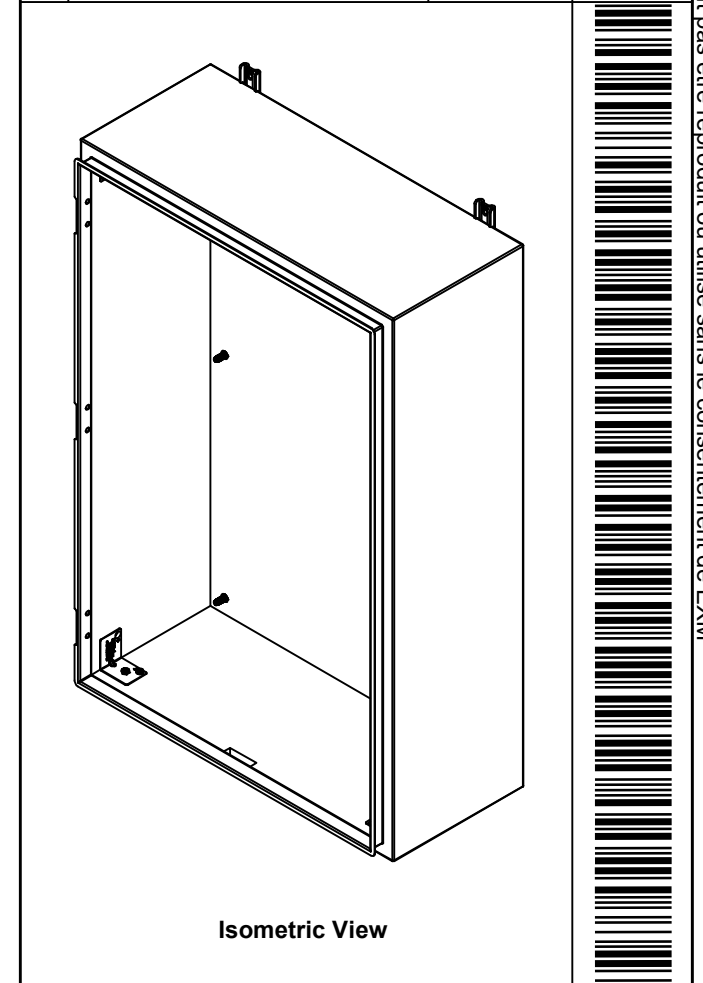

 Tél: (450) 979-4373 Fax: (450) 979-4626 www.exmweb.com		Flatness Aplatissement	
		Max 3.0mm	
Customer Client		Date	
Drawn By Dessiné Par BoxCad: BoxCad		Date 27-Feb-25	
Material Matière 16 Ga Cold Rolled A1008 CS Type B (1.4mm)			
Color Couleur Asa-61 Grey		Finish Fini Smooth	
Description 5412ESPR 36" x 24" x 10" Body			Detail Rev.
Part Number Numéro Pièce 5412ESPR362410THB		Rev. 0	3
SEE BILL OF MATERIAL ON LAST PAGE		SEE BILL OF MATERIAL ON LAST PAGE	
		SEE BILL OF MATERIAL ON LAST PAGE	

SEE BILL OF MATERIAL ON LAST PAGE

This drawing is confidential and must not be reproduced or used without the consent of EXM

Ce dessin est confidentiel et ne doit pas être reproduit ou utilisé sans le consentement de EXM

STANDARD FEATURES ARE NOT LISTED IN THIS HOLE TABLE			
HOLE TABLE - TOP VIEW (CUSTOM FEATURE ONLY)			
CUT-OUT	XDIM	YDIM	DESCRIPTION
1	2.000	8.500	INSUL. STUD M6 x 18mm (Inside)
2	22.000	8.500	INSUL. STUD M6 x 18mm (Inside)

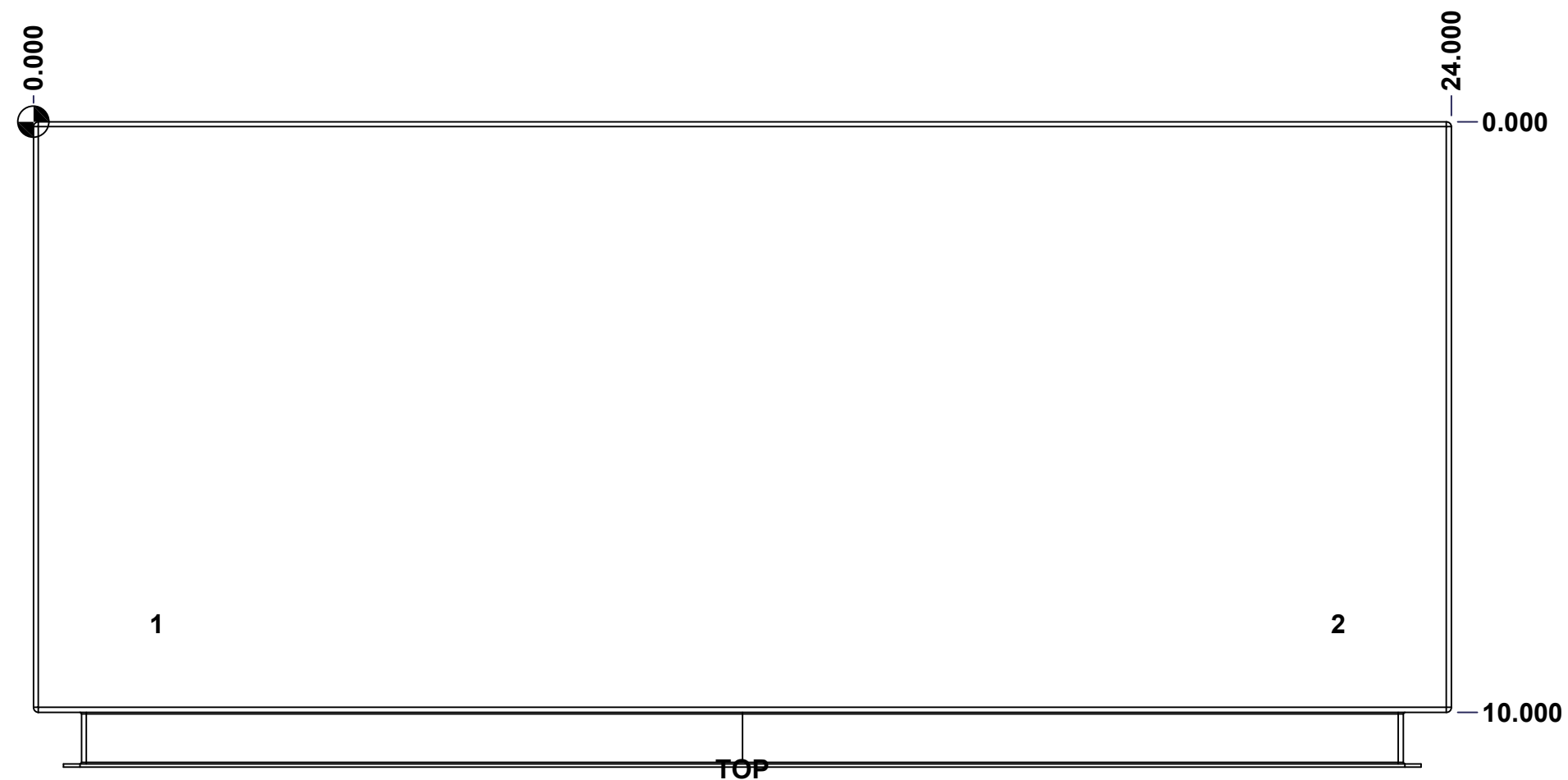

	Description	Status
	5412ESPR 36" x 24" x 10" Body	(NULL)
	Part Number Numéro Pièce	Rev.
	5412ESPR362410THB	0 / 4
		16

This drawing is confidential and must not be reproduced or used without the consent of EXM

Ce dessin est confidentiel et ne doit pas être reproduit ou utilisé sans le consentement de EXM

STANDARD FEATURES ARE NOT LISTED IN THIS HOLE TABLE			
HOLE TABLE - BOTTOM VIEW (CUSTOM FEATURE ONLY)			
CUT-OUT	XDIM	YDIM	DESCRIPTION
1	2.000	8.500	INSUL. STUD M6 x 18mm (Inside)
2	22.000	8.500	INSUL. STUD M6 x 18mm (Inside)

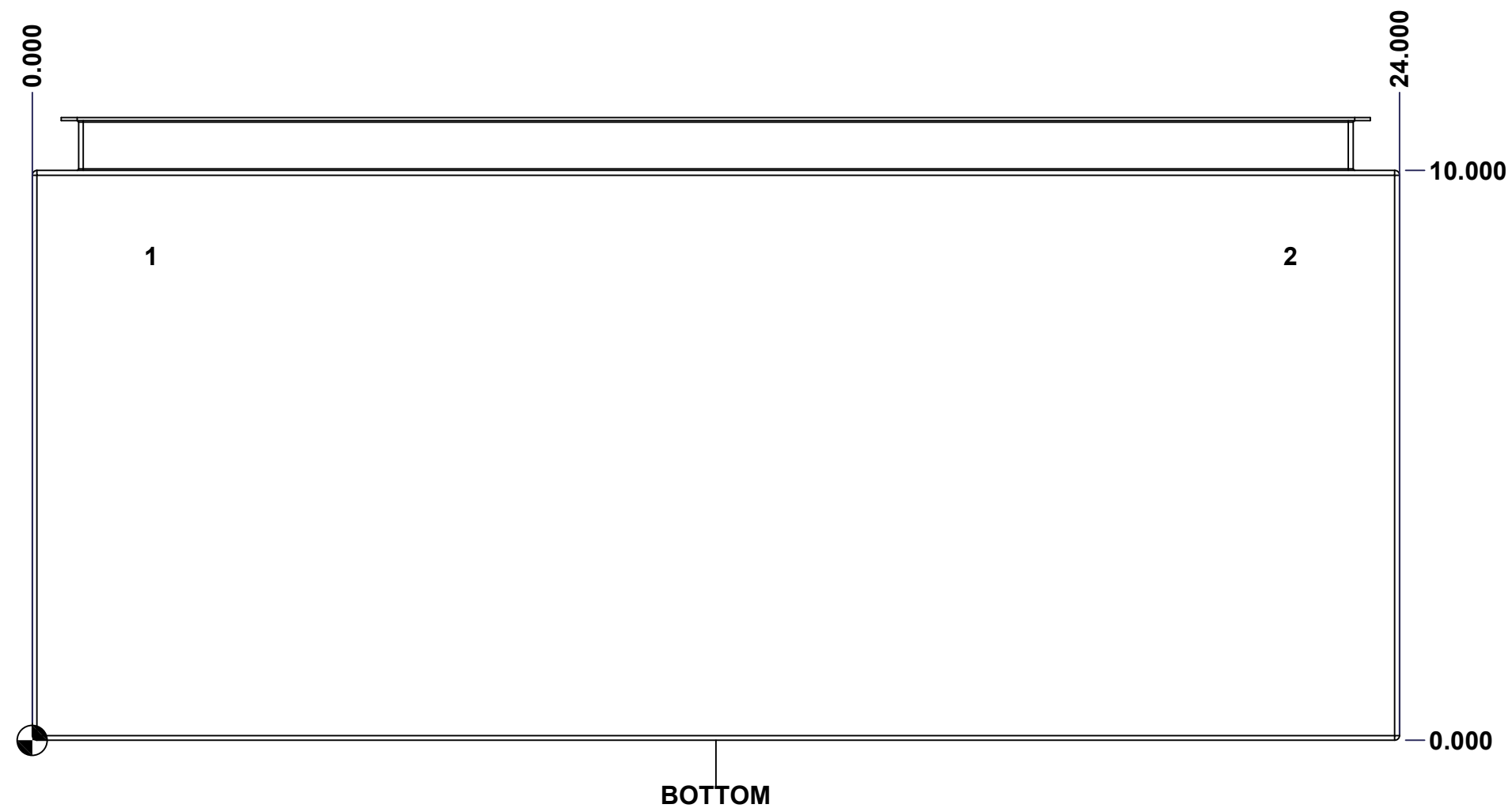

	Description	Status
	5412ESPR 36" x 24" x 10" Body	(NULL)
Part Number Numéro Pièce 5412ESPR362410THB	Rev.	5
	0	16

This drawing is confidential and must not be reproduced or used without the consent of EXM

Ce dessin est confidentiel et ne doit pas être reproduit ou utilisé sans le consentement de EXM

STANDARD FEATURES ARE NOT LISTED IN THIS HOLE TABLE

HOLE TABLE - BACK VIEW (CUSTOM FEATURE ONLY)

CUT-OUT	XDIM	YDIM	DESCRIPTION
1	1.875	1.875	IP STUD M8 x 35mm (Inside)
2	1.875	34.125	IP STUD M8 x 35mm (Inside)
3	22.125	34.125	IP STUD M8 x 35mm (Inside)
4	22.125	1.875	IP STUD M8 x 35mm (Inside)
5	1.875	18.000	IP STUD M8 x 35mm (Inside)
6	22.125	18.000	IP STUD M8 x 35mm (Inside)

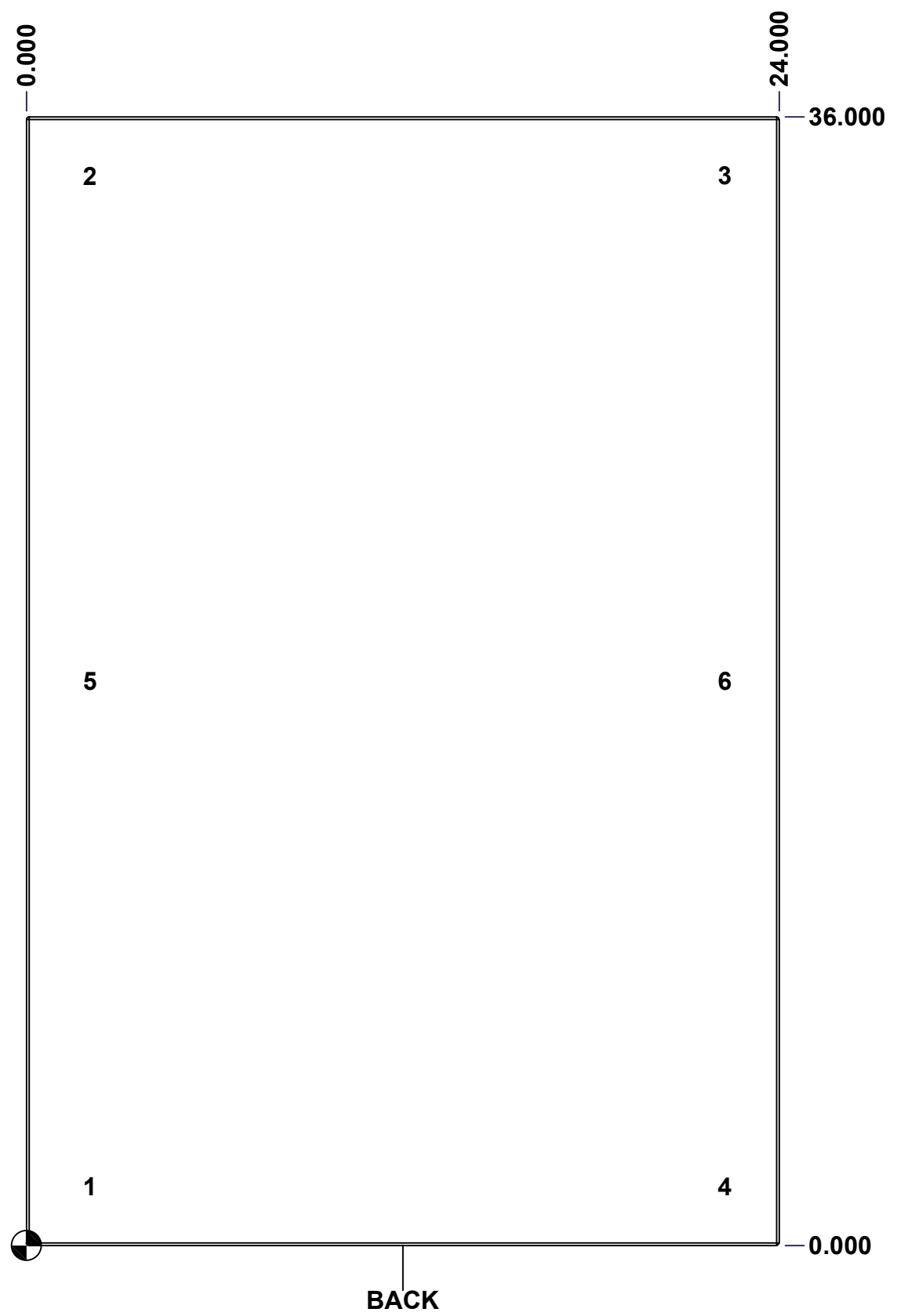

	Description	Status
	5412ESPR 36" x 24" x 10" Body	(NULL)
	Part Number Numéro Pièce	Rev.
	5412ESPR362410THB	0 / 6
		16

This drawing is confidential and must not be reproduced or used without the consent of EXM

Ce dessin est confidentiel et ne doit pas être reproduit ou utilisé sans le consentement de EXM

No.	Revisions	Date	By/Par

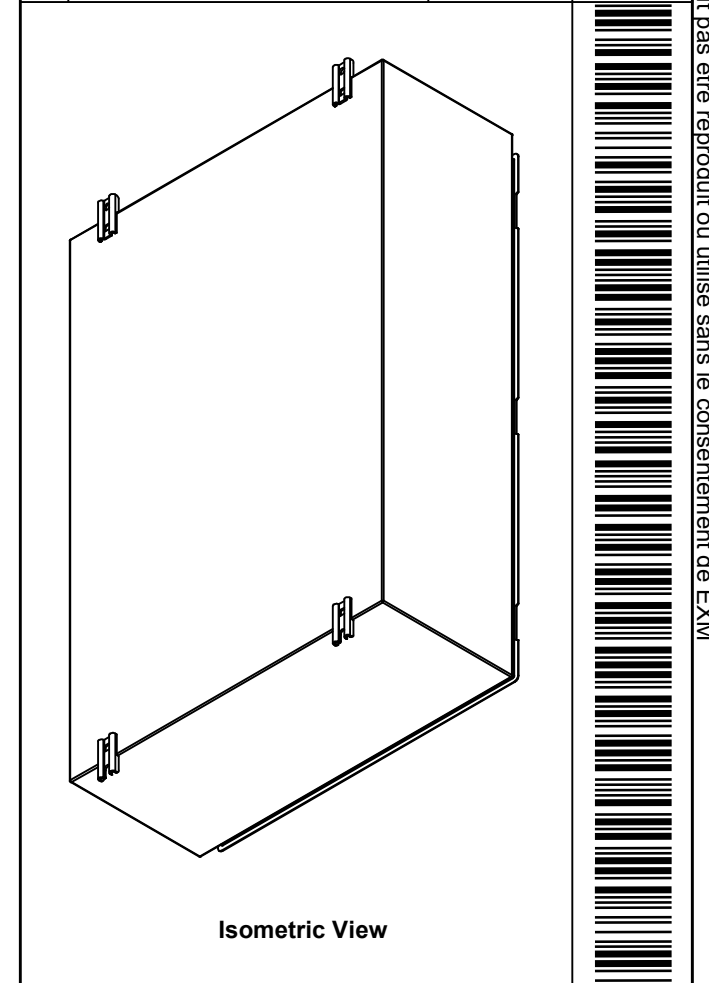

1	STK-K-70554	3	5412 ESTH Accessory Kit
1	5412ESPR362410THI-RS	0	5412ESPR 36" x 24" Right Insulation
1	5412ESPR362410THI-LS	0	5412ESPR 36" x 24" Left Insulation
1	5412ESPR362410THI-BT	0	5412ESPR 36" x 24"Bottom Insulation
1	5412ESPR362410THI-TP	0	5412ESPR 36" x 24"Top Insulation
1	5412ESPR362410THI-B	0	5412ESPR 36" x 24" Back Insulation
4	STK-Q-16055	1	M6 x 18mm Stud (No Paint Cap Required)
2	885ESMF3-FEET	0	885 ESMF3 Mounting Foot (Close)
2	885ESMF3-FEET-A	0	885 ESMF3 Mounting Foot (Open)
1	STK-P-02400S	0	Powder Paint (Asa-61 Grey / Smooth)
6	STK-Q-16005	0	Stud M8 x 35mm Steel
1	5412ESPR362410THB-P	0	5412ESPR 36" x 24" x 10" Body Part
Qty	Part Number	Rev	Description
Parts List			

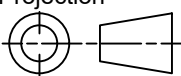
 Tél: (450) 979-4373 Fax: (450) 979-4626 www.exmweb.com		Flatness Aplatissement Max 3.0mm Projection 
Customer Client	Date	Date
Drawn By Dessiné Par	BoxCad: BoxCad	Date 27-Feb-25
Material Matière	16 Ga Cold Rolled A1008 CS Type B (1.4mm)	
Color Couleur	Asa-61 Grey	Finish Fini Smooth
Description		Detail Rev.
5412ESPR 36" x 24" x 10" Body		
Part Number Numéro Pièce	Rev.	7
5412ESPR362410THB	0	16

This drawing is confidential and must not be reproduced or used without the consent of EXM

Ce dessin est confidentiel et ne doit pas être reproduit ou utilisé sans le consentement de EXM

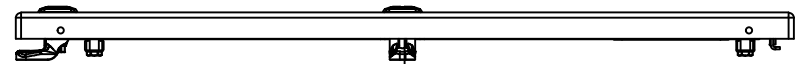

TOP

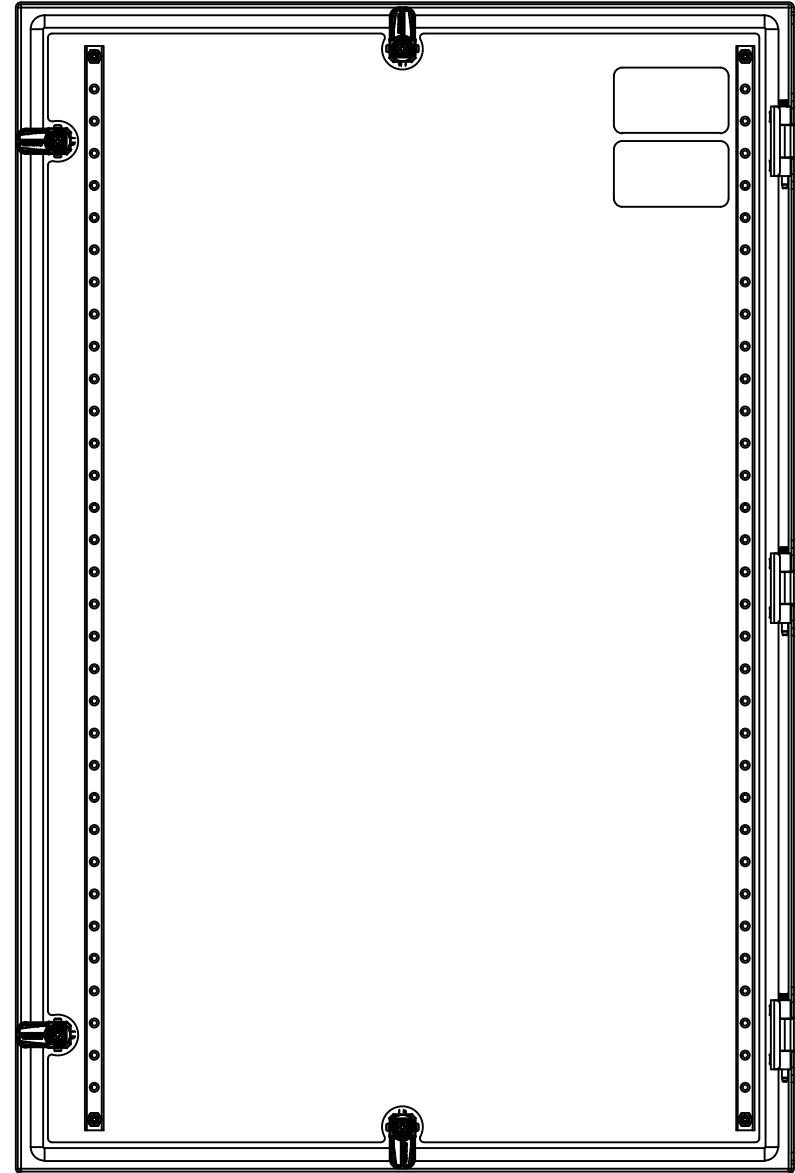

BACK



BOTTOM

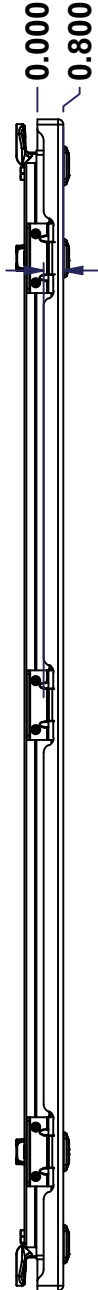

LEFT

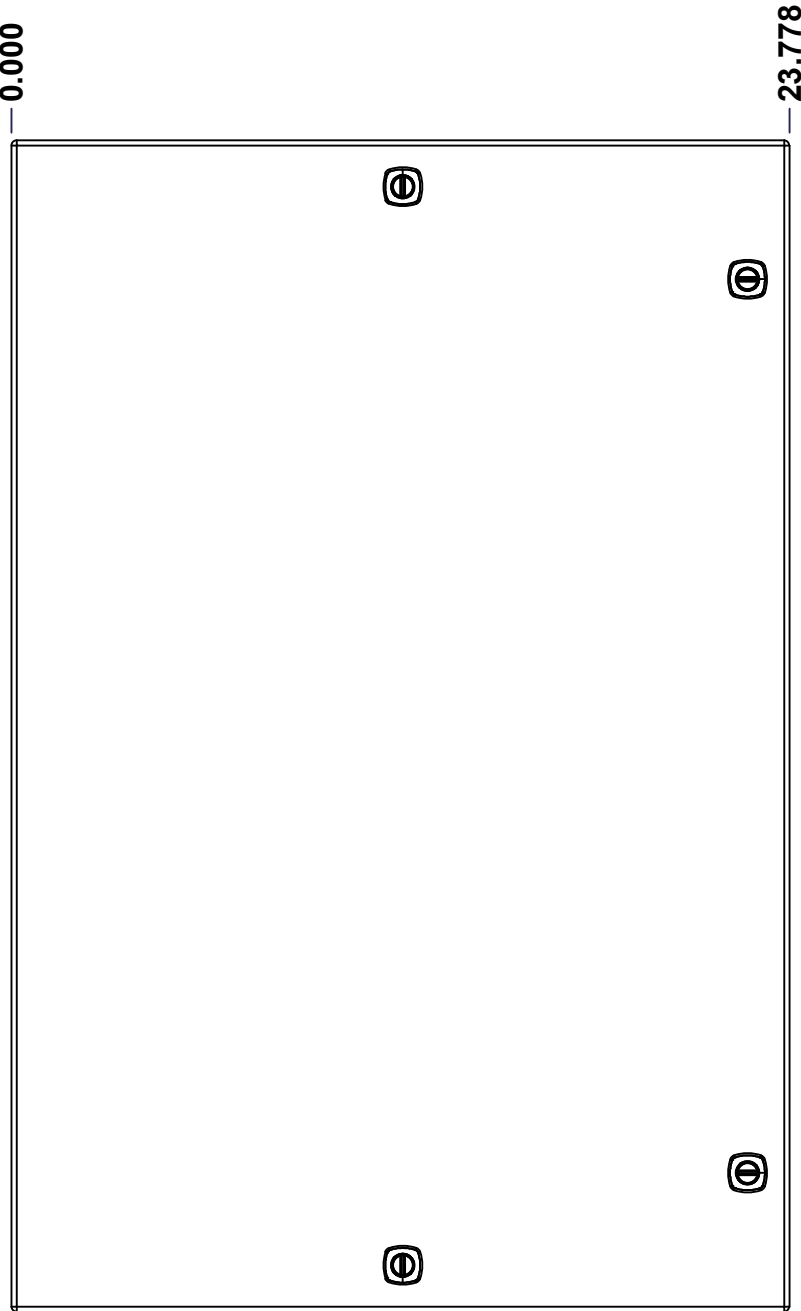

FRONT

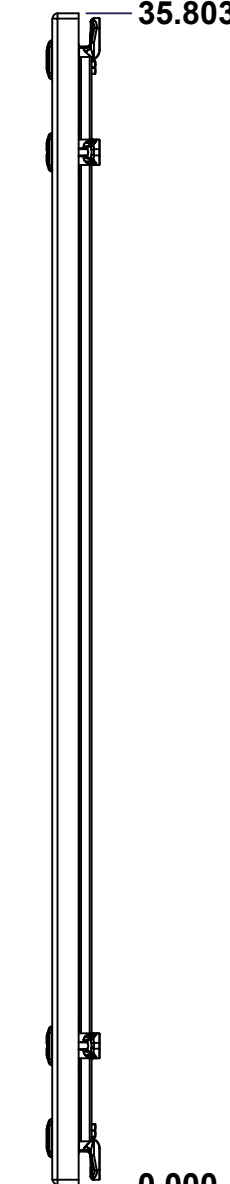

RIGHT

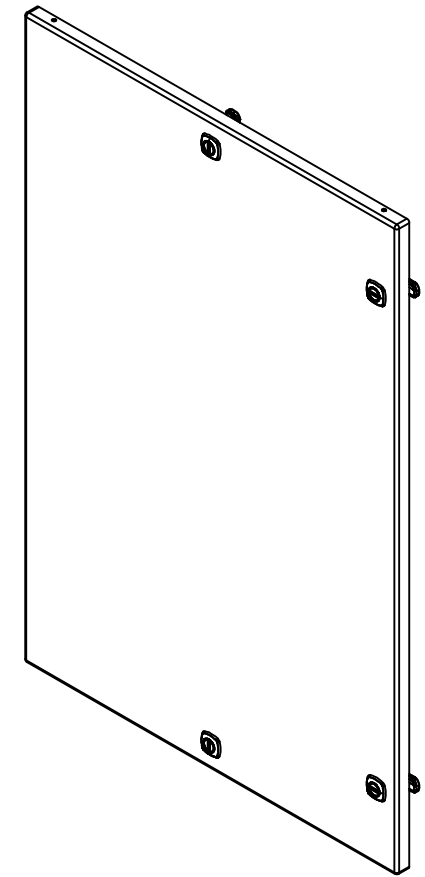

Isometric View

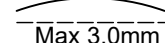
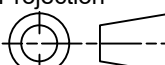

No.	Revisions	Date	By/Par

 Tél: (450) 979-4373 Fax: (450) 979-4626 www.exmweb.com		Flatness Aplatissement  Max 3.0mm Projection 
Customer Client	Date	
Drawn By Dessiné Par	BoxCad: BoxCad	Date 27-Feb-25
Material Matière	14 Ga Cold Rolled A1008 CS Type B (1.7mm)	
Color Couleur	Asa-61 Grey	Finish Fini Smooth
Description	Detail Rev.	
5412ESPR 36" x 24" Cover		
Part Number Numéro Pièce	Rev.	8
5412ESPR362410THC	0	16

SEE BILL OF MATERIAL ON LAST PAGE

This drawing is confidential and must not be reproduced or used without the consent of EXM

Ce dessin est confidentiel et ne doit pas être reproduit ou utilisé sans le consentement de EXM

STANDARD FEATURES ARE NOT LISTED IN THIS HOLE TABLE

HOLE TABLE - FRONT VIEW (CUSTOM FEATURE ONLY)

CUT-OUT	XDIM	YDIM	DESCRIPTION
1	1.486	1.661	STUD M6 x 18mm (Inside)
2	1.486	34.142	STUD M6 x 18mm (Inside)
3	21.377	34.142	STUD M6 x 18mm (Inside)
4	21.377	1.661	STUD M6 x 18mm (Inside)

5	22.494	31.553	LOCK 880 SCQ4-SL @ 0.0°
6	22.494	4.250	LOCK 880 SCQ4-SL @ 0.0°
7	11.959	34.379	LOCK 880 SCQ4-SL @ 90.0°
8	11.959	1.424	LOCK 880 SCQ4-SL @ 270.0°

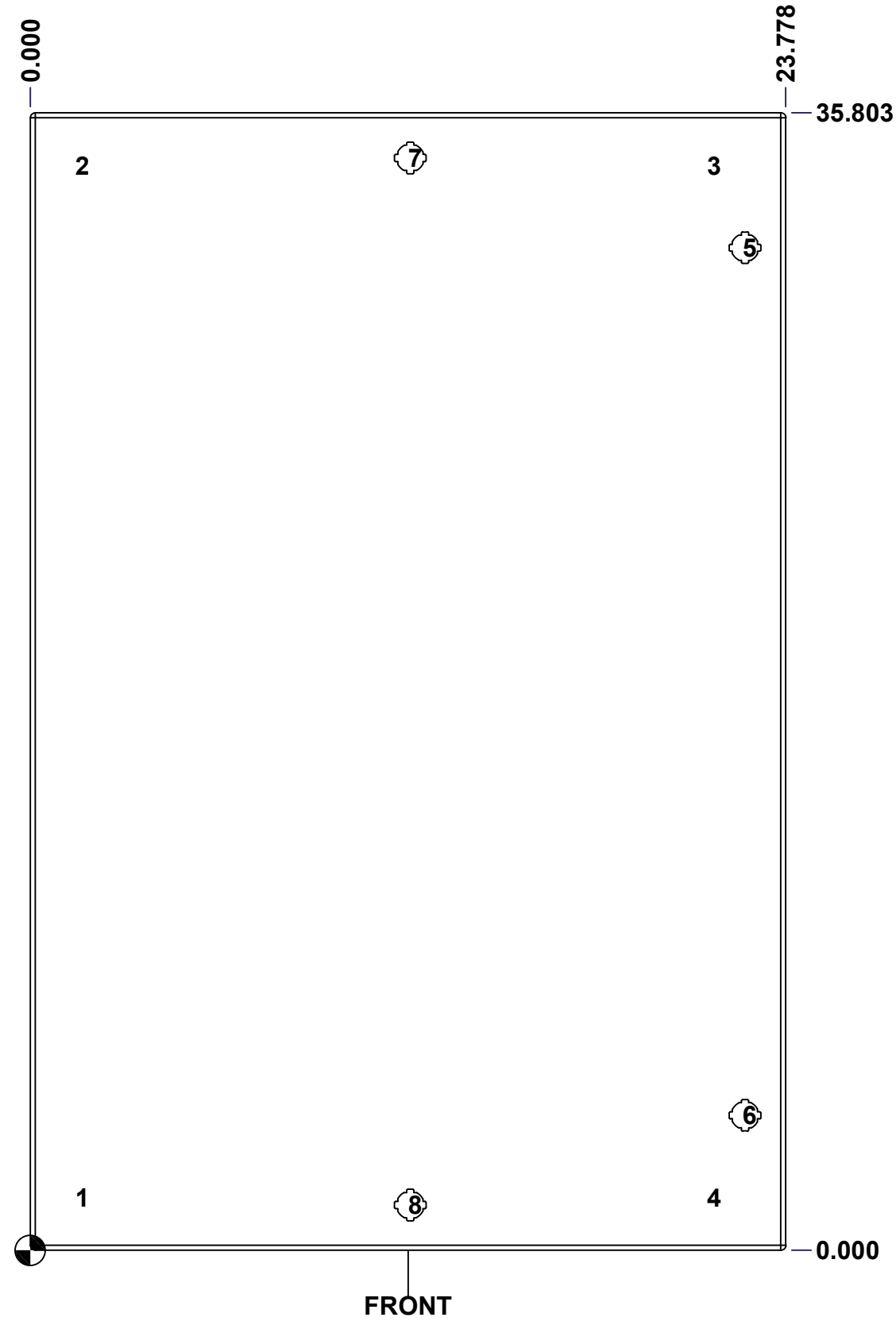

	Description	Status
	5412ESPR 36" x 24" Cover	(NULL)
	Part Number Numéro Pièce	Rev.
	5412ESPR362410THC	0 / 9
		16

This drawing is confidential and must not be reproduced or used without the consent of EXM

Ce dessin est confidentiel et ne doit pas être reproduit ou utilisé sans le consentement de EXM

No.	Revisions	Date	By/Par

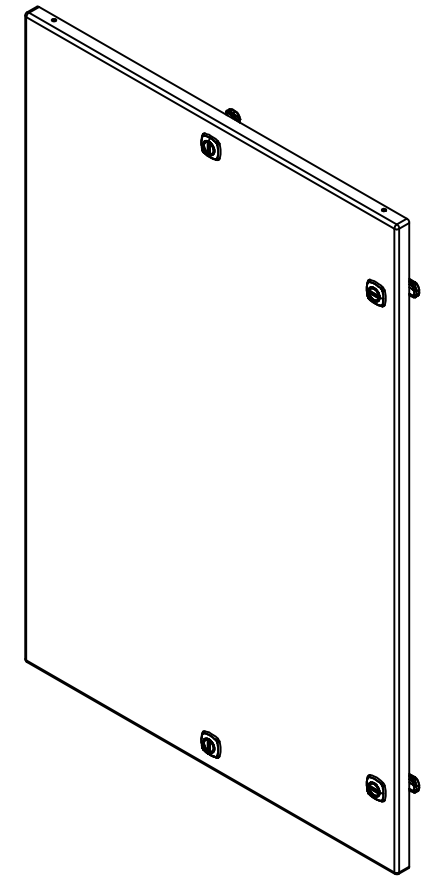

Isometric View

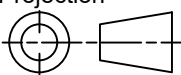

 Tél: (450) 979-4373 Fax: (450) 979-4626 www.exmweb.com		Flatness Aplatissement Max 3.0mm Projection 
Customer Client	Date	
Drawn By Dessiné Par	BoxCad: BoxCad	Date 27-Feb-25
Material Matière	14 Ga Cold Rolled A1008 CS Type B (1.7mm)	
Color Couleur	Asa-61 Grey	Finish Fini Smooth
Description		Detail Rev.
5412ESPR 36" x 24" Cover		
Part Number Numéro Pièce	Rev. 0	10 / 16
5412ESPR362410THC		

QTY	Part Number	Rev	Description
4	STK-K-12500	19	5412 ES 1/4 Turn Lock
2	STK-S-00100	0	3.5" x 2" Silver Milar Flexcon Sticker
4	STK-Q-07250	2	M6 x 16mm Collar Nut
2	STK-Q-46020-36	5	5412 ES Vertical Door Stiffener 36"
1	5412ESPR362410THI-C	0	5412ESPR 36" x 24" Cover Insulation
4	STK-Q-16055	1	M6 x 18mm Stud (No Paint Cap Required)
1	5412ESPR362410THG	0	5412ESPR 36" x 24" Cover Gasket Part
1	5412ESPR362410THC-P	0	5412ESPR 36" x 24" Cover Part
3	STK-A-33005PR	1	5412 ESPR Hinge 180° (Body Part)
Parts List			

This drawing is confidential and must not be reproduced or used without the consent of EXM

Ce dessin est confidentiel et ne doit pas être reproduit ou utilisé sans le consentement de EXM

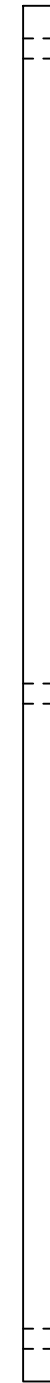
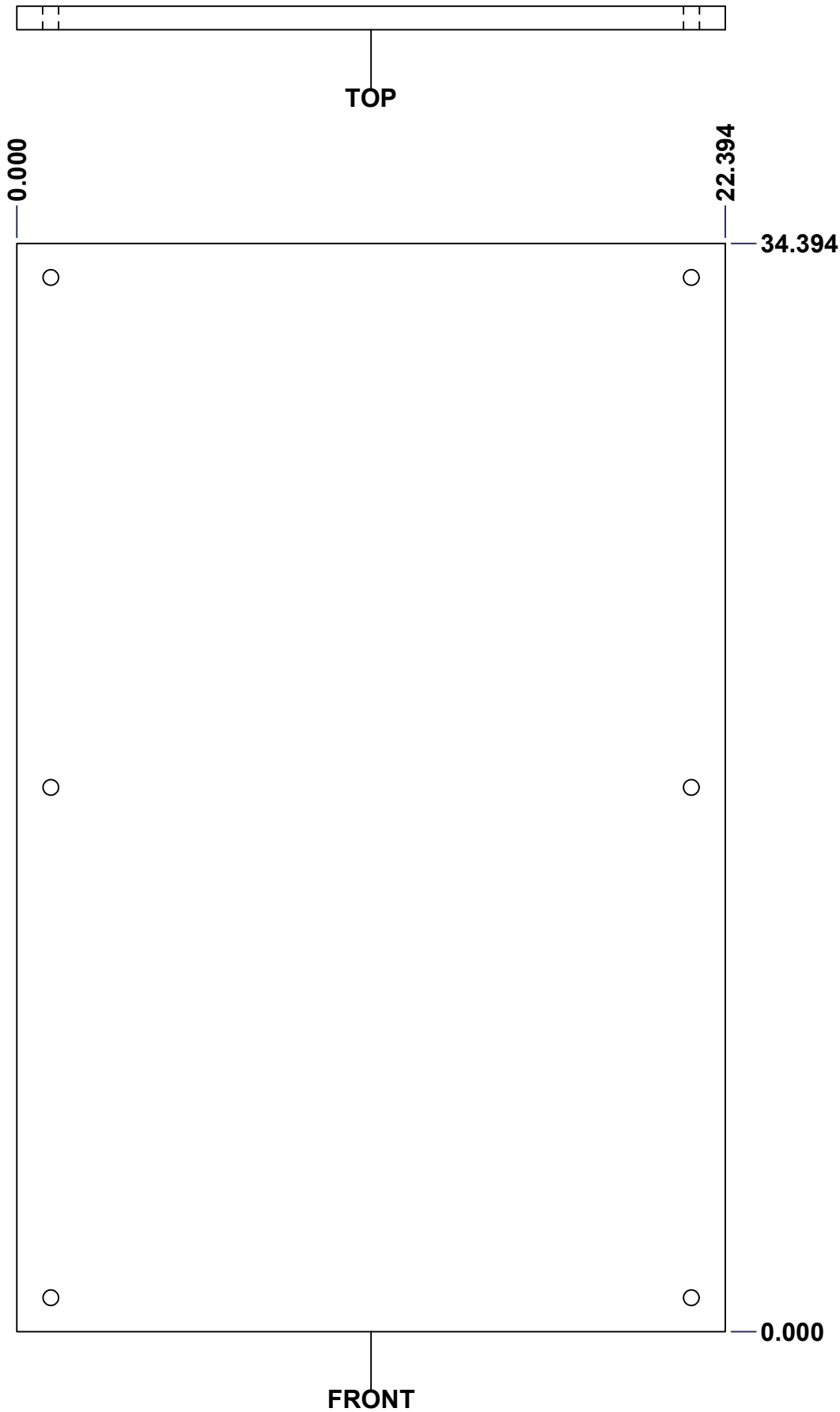

No.	Revisions	Date	By/Par

Isometric View

<p>Tél: (450) 979-4373 Fax: (450) 979-4626 www.exmweb.com</p>		Flatness Aplatissement	
		Max 3.0mm	
Customer Client		Date	
Drawn By Dessiné Par		Date	
Material Matière		Polyisocyanurate	
Color Couleur		Finish Fini	
Aluminum		N/A	
Description			Detail Rev.
5412ESPR 36" x 24" Back Insulation			
Part Number Numéro Pièce		Rev.	
5412ESPR362410THI-B		0	11 16

SEE BILL OF MATERIAL ON LAST PAGE

This drawing is confidential and must not be reproduced or used without the consent of EXM

Ce dessin est confidentiel et ne doit pas être reproduit ou utilisé sans le consentement de EXM

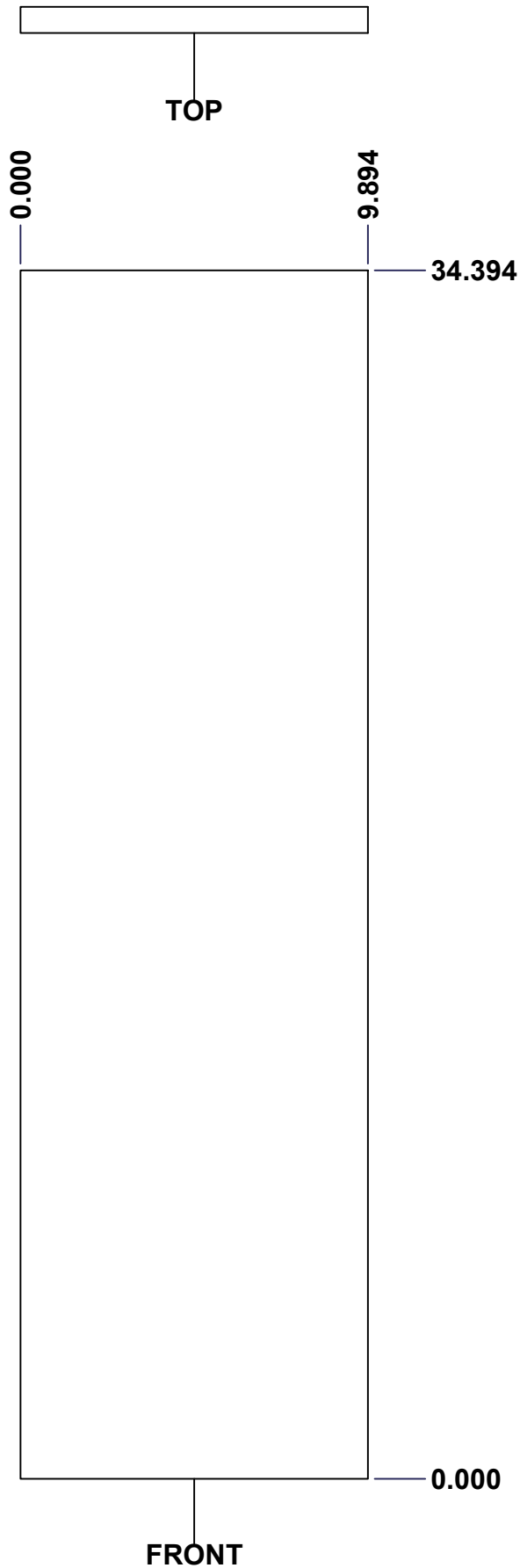

No.	Revisions	Date	By/Par

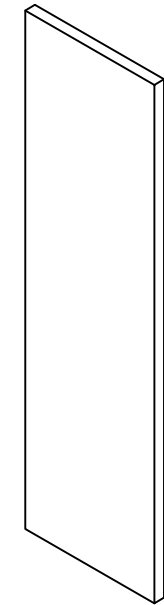

Isometric View



 Tél: (450) 979-4373 Fax: (450) 979-4626 www.exmweb.com		Flatness Aplatissement	
		Max 3.0mm	
Customer Client		Date	
Drawn By Dessiné Par		Date	
Material Matière		Polyisocyanurate	
Color Couleur		Finish Fini	
Aluminum		N/A	
Description		Detail Rev.	
5412ESPR 36" x 24" Left Insulation			
Part Number Numéro Pièce		Rev.	
5412ESPR362410THI-LS		0	12 / 16

SEE BILL OF MATERIAL ON LAST PAGE

This drawing is confidential and must not be reproduced or used without the consent of EXM

Ce dessin est confidentiel et ne doit pas être reproduit ou utilisé sans le consentement de EXM

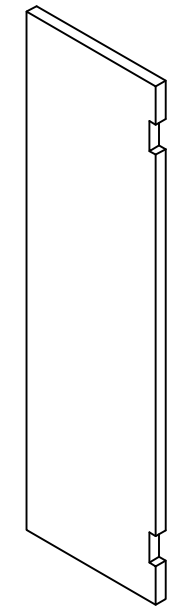
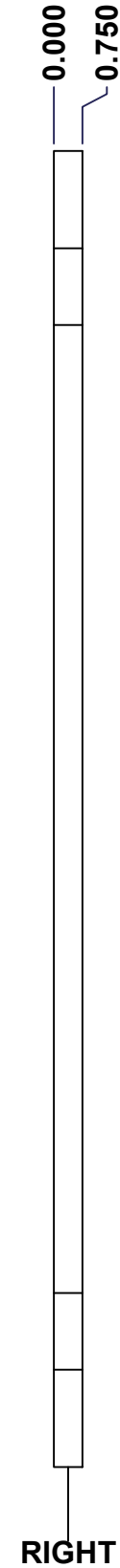
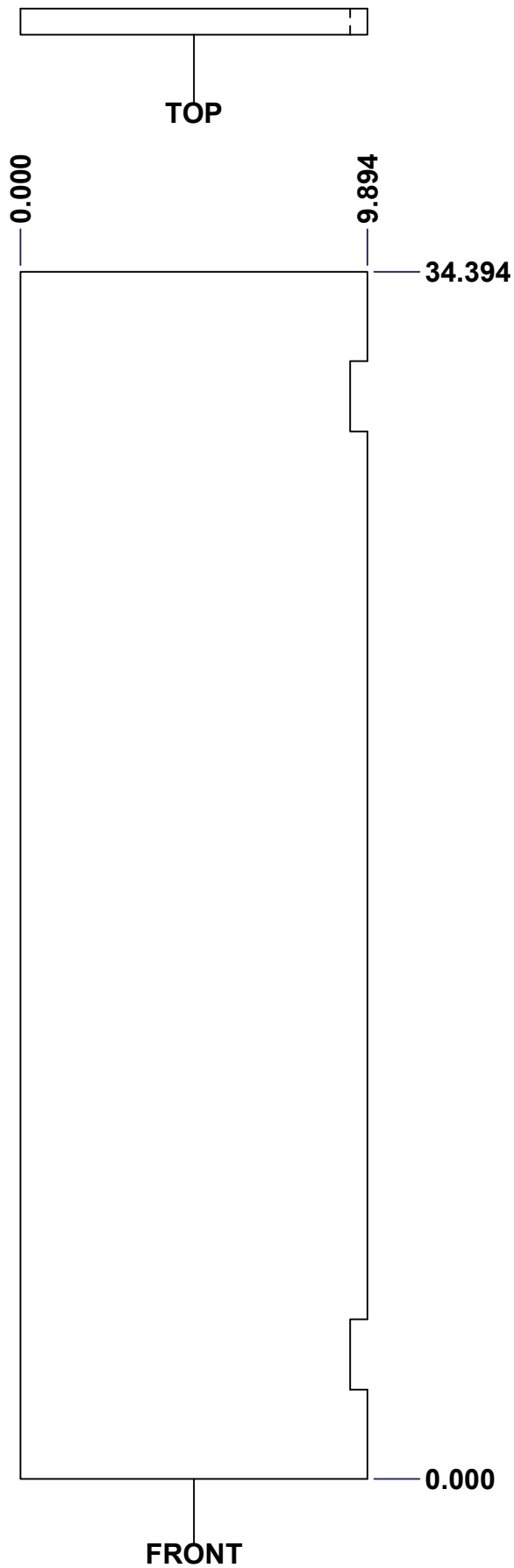

Isometric View

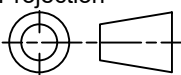

No.	Revisions	Date	By/Par

 Tél: (450) 979-4373 Fax: (450) 979-4626 www.exmweb.com		Flatness Aplatissement Max 3.0mm Projection 
Customer Client	Date	
Drawn By Dessiné Par	BoxCad: Patrick Deschenes	Date 23-Jan-07
Material Matière	Polyisocyanurate	
Color Couleur	Aluminum	Finish Fini N/A
Description	Detail Rev.	
5412ESPR 36" x 24" Right Insulation		
Part Number Numéro Pièce	Rev. 0	13 / 16
5412ESPR362410THI-RS		

SEE BILL OF MATERIAL ON LAST PAGE

This drawing is confidential and must not be reproduced or used without the consent of EXM

Ce dessin est confidentiel et ne doit pas être reproduit ou utilisé sans le consentement de EXM

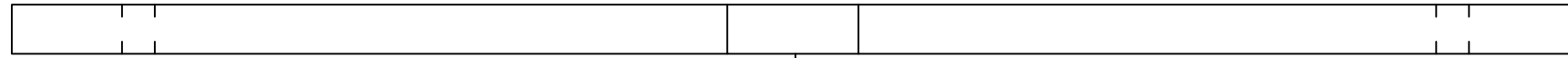

TOP

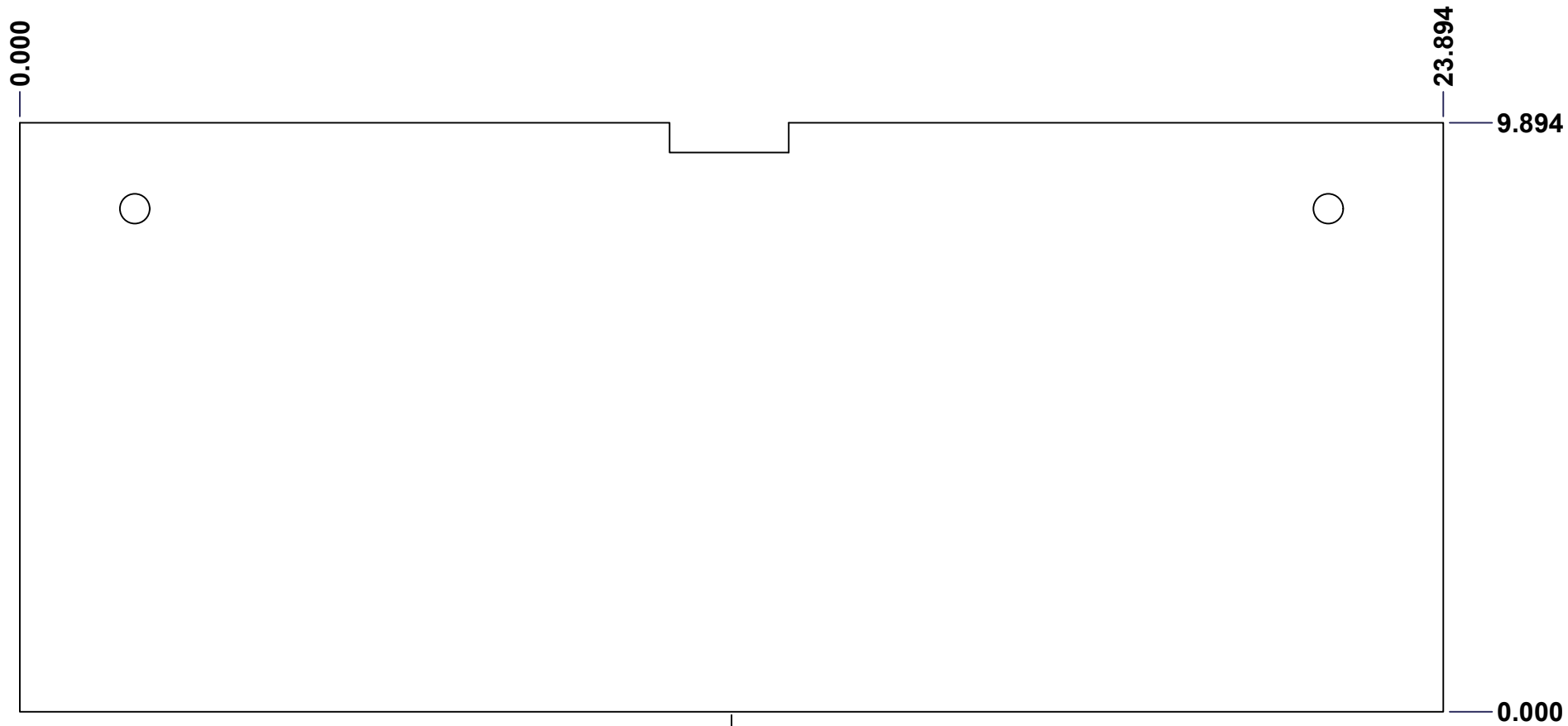

FRONT

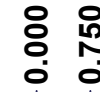

RIGHT

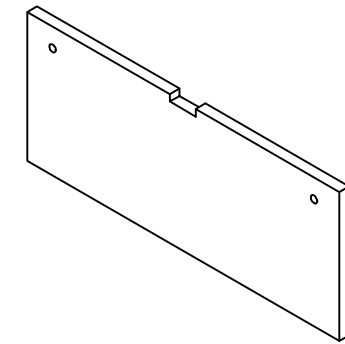

Isometric View

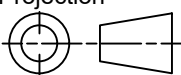

No.	Revisions	Date	By/Par

 Tél: (450) 979-4373 Fax: (450) 979-4626 www.exmweb.com		Flatness Aplatissement Max 3.0mm Projection 
Customer Client	Date	
Drawn By / Dessiné Par: BoxCad: BoxCad	Date: 4/3/2024	
Material / Matière: Polyisocyanurate		
Color / Couleur: Aluminum	Finish / Fini: Smooth	
Description: 5412ESPR 36" x 24"Top Insulation		Detail Rev.
Part Number / Numéro Pièce: 5412ESPR362410THI-TP	Rev. 0	14 / 16

SEE BILL OF MATERIAL ON LAST PAGE

This drawing is confidential and must not be reproduced or used without the consent of EXM

Ce dessin est confidentiel et ne doit pas être reproduit ou utilisé sans le consentement de EXM

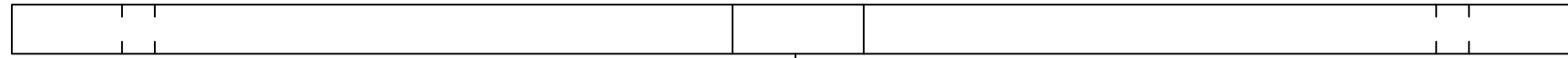

TOP

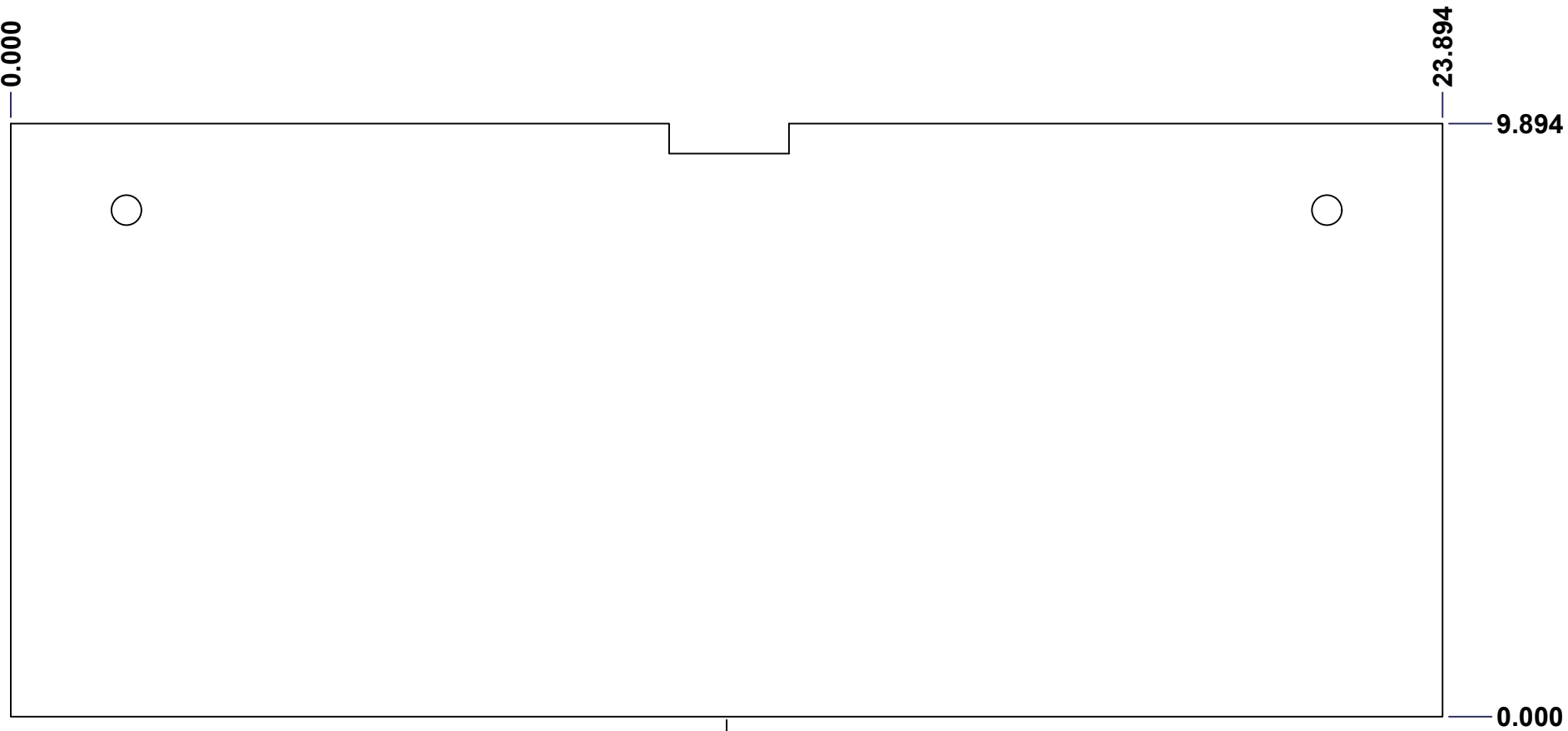

FRONT

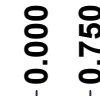

RIGHT

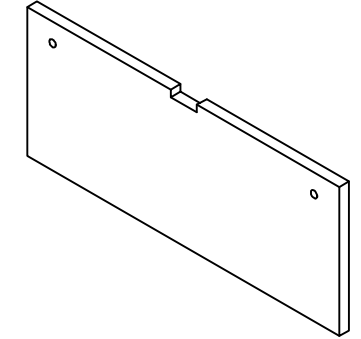

Isometric View



Tél: (450) 979-4373
 Fax: (450) 979-4626
www.exmweb.com

Flatness
 Aplatissement
 Max 3.0mm
 Projection

Customer Client	Date
Drawn By / Dessiné Par: BoxCad: BoxCad	Date: 4/3/2024
Material / Matière: Polyisocyanurate	
Color / Couleur: Aluminum	Finish / Fini: Smooth
Description: 5412ESPR 36" x 24"Bottom Insulation	Detail Rev.
Part Number / Numéro Pièce: 5412ESPR362410THI-BT	Rev. 0

SEE BILL OF MATERIAL ON LAST PAGE

This drawing is confidential and must not be reproduced or used without the consent of EXM

Ce dessin est confidentiel et ne doit pas être reproduit ou utilisé sans le consentement de EXM

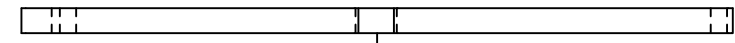

TOP

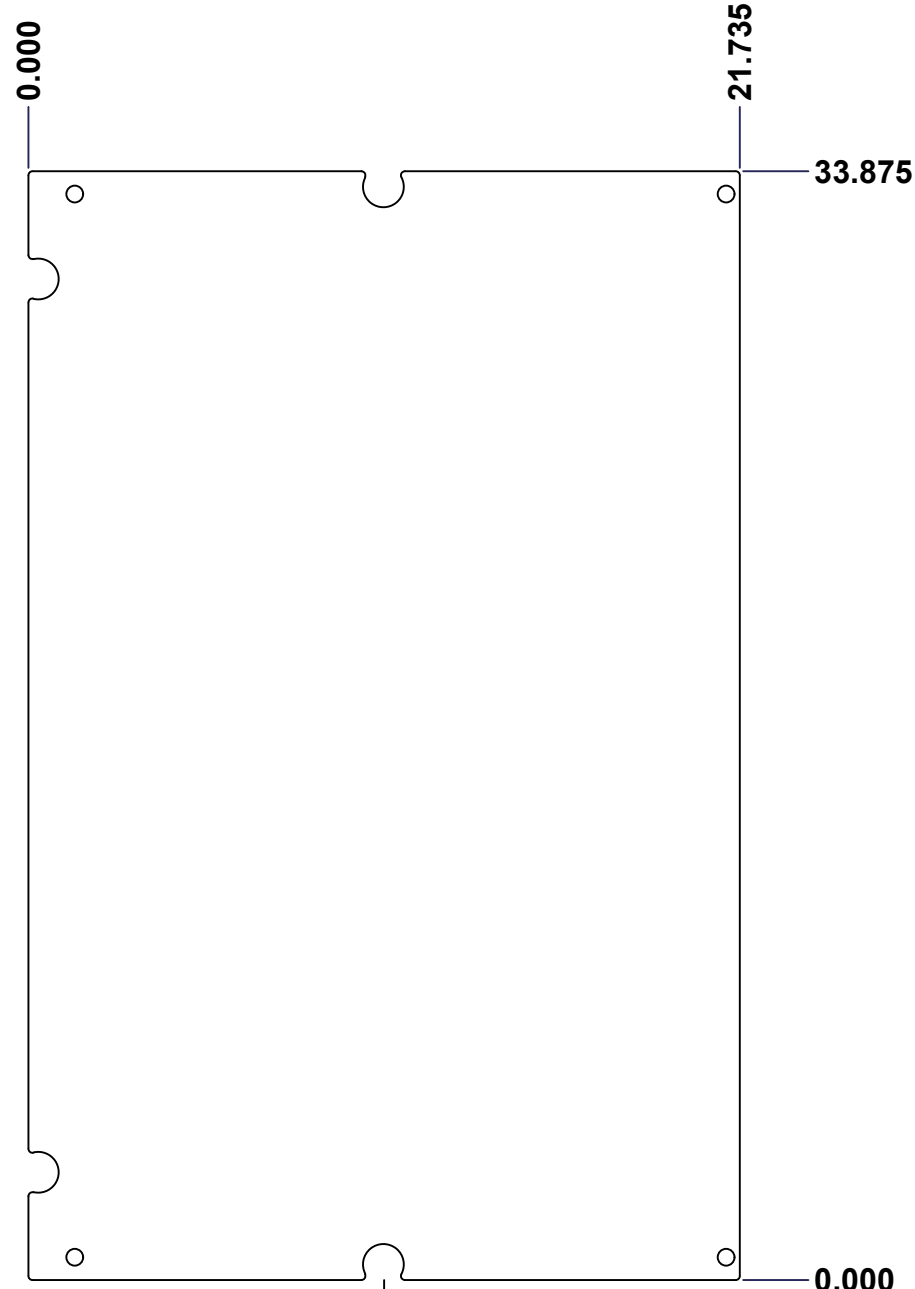

FRONT

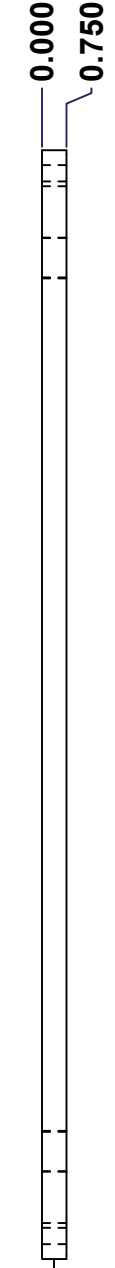

RIGHT

No.	Revisions	Date	By/Par

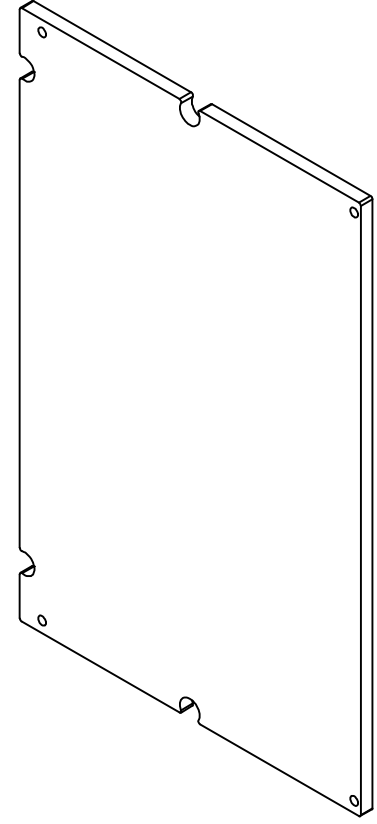

Isometric View



Tél: (450) 979-4373
 Fax: (450) 979-4626
www.exmweb.com

Flatness
Aplatissement
Max 3.0mm
Projection

Customer Client	Date
Drawn By / Dessiné Par: BoxCad: Patrick Deschenes	Date: 23-Jan-07
Material / Matière: Polyisocyanurate	
Color / Couleur: Aluminum	Finish / Fini: N/A

Description: 5412ESPR 36" x 24" Cover Insulation	Detail Rev.
--	-------------

Part Number / Numéro Pièce: 5412ESPR362410THI-C	Rev. 0	16 / 16
---	--------	---------

SEE BILL OF MATERIAL ON LAST PAGE

This drawing is confidential and must not be reproduced or used without the consent of EXM

Ce dessin est confidentiel et ne doit pas être reproduit ou utilisé sans le consentement de EXM



No.	Revisions	Date	By/Par

Isometric View

Tél: (450) 979-4373 Fax: (450) 979-4626 www.exmweb.com		Flatness Aplatissement Max 3.0mm Projection
Customer Client	Date	
Drawn By Dessiné Par: BoxCad	Date: 23-Jan-07	
Material Matière	See Part List	
Color Couleur	See Part List	Finish Fini: See Part List
Description: 881 SP - Inner Panel		Detail Rev.
Part Number Numéro Pièce: 881 SP3624G	Rev. 0	1 2

Qty	Part Number	Rev	Description	Material	Color	Finish
1	881 SP3624G-P	0	881 SP - Inner Panel Part	12 Ga Galvanized	Unpainted	Galvanized

Parts List

This drawing is confidential and must not be reproduced or used without the consent of EXM

Ce dessin est confidentiel et ne doit pas être reproduit ou utilisé sans le consentement de EXM

Table 1			FRONT VIEW
CUT-OUT	XDIM	YDIM	DESCRIPTION
1	0.875	1.875	GROUND HOLE (RND Ø0.290)
2	21.125	1.875	GROUND HOLE (RND Ø0.290)
3	0.875	32.125	GROUND HOLE (RND Ø0.290)
4	21.125	32.125	GROUND HOLE (RND Ø0.290)
5	0.875	17.000	MTG STUD HOLE (RND Ø0.500)
6	21.125	17.000	MTG STUD HOLE (RND Ø0.500)

All knockouts are actual size / Les disques défonçables sont grandeur réel



No.	Revisions	Date	By/Par

Isometric View

		Tél: (450) 979-4373 Fax: (450) 979-4626 www.exmweb.com	Flatness Aplatissement Max 3.0mm Projection
Customer Client			Date
Drawn By / Dessiné Par	BoxCad	Date 23-Jan-07	
Material / Matière	See Part List		
Color / Couleur	See Part List	Finish / Fini	See Part List
Description		Detail Rev.	
881 SP - Inner Panel			
Part Number / Numéro Pièce	881 SP3624G	Rev.	2
		0	2