

This drawing is confidential and must not be reproduced or used without the consent of EXM

Ce dessin est confidentiel et ne doit pas être reproduit ou utilisé sans le consentement de EXM

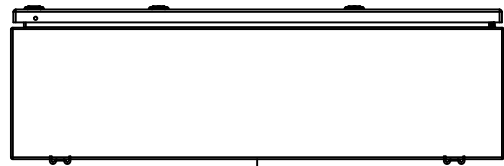

TOP

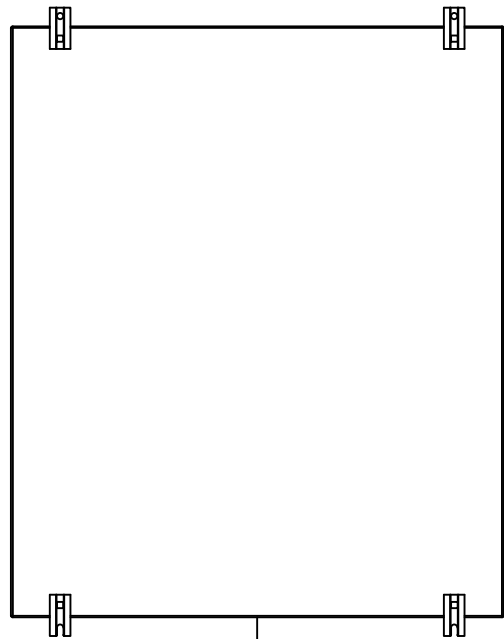

BACK

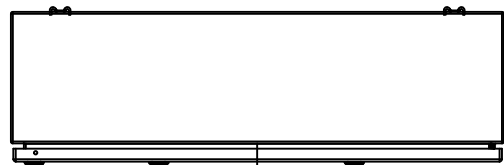

BOTTOM

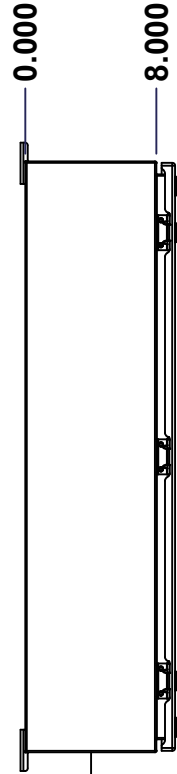

LEFT

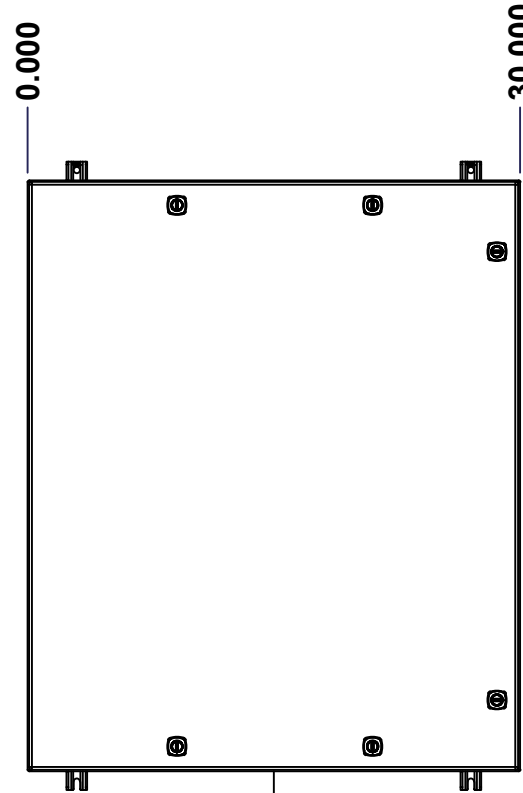

FRONT

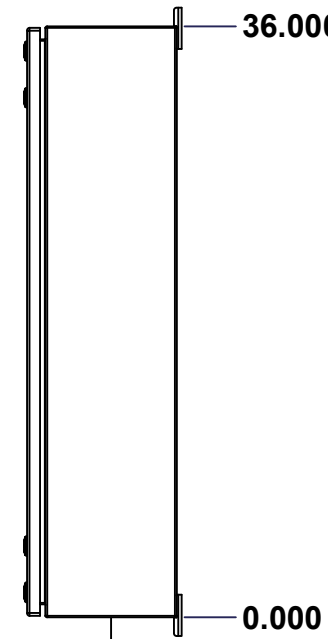

RIGHT

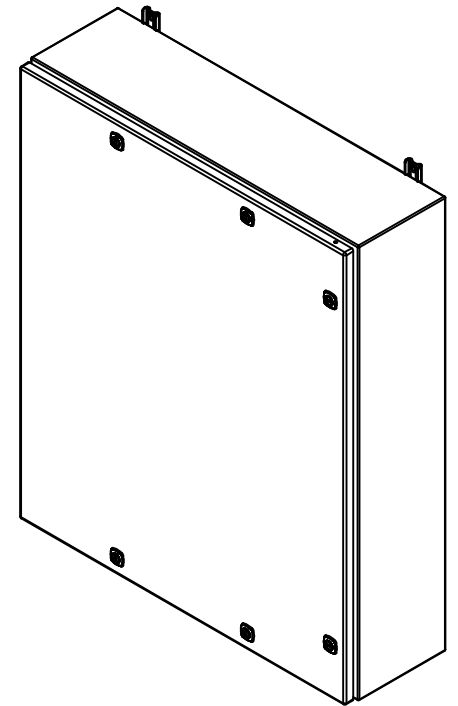

Isometric View

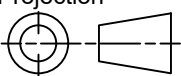

| No. | Revisions | Date | By/Par |
|-----|-----------|------|--------|
| | | | |
| | | | |
| | | | |
| | | | |

| | | |
|--|---|---|
|  Tél: (450) 979-4373 Fax: (450) 979-4626 www.exmweb.com | | Flatness Aplatissement Max 3.0mm Projection  |
| Customer Client | Date | |
| Drawn By Dessiné Par | BoxCad: BoxCad | Date 05-Mar-25 |
| Material Matière | 14 Ga Cold Rolled A1008 CS Type B (1.7mm) | |
| Color Couleur | Asa-61 Grey | Finish Fini Smooth |
| Description | Detail Rev. | |
| 5412ESPR 36" x 30" x 8" Assembly | | |
| Part Number Numéro Pièce | Rev. 0 | 1 / 16 |

SEE BILL OF MATERIAL ON LAST PAGE

5412ESPR363008TH

This drawing is confidential and must not be reproduced or used without the consent of EXM

Ce dessin est confidentiel et ne doit pas être reproduit ou utilisé sans le consentement de EXM

| NOTE | |
|------|--|
| ITEM | DESCRIPTION |
| 1 | NEMA 4, 12 Enclosure (IP66) |
| 2 | C/W Standard ground studs on box and cover |
| 3 | C/W Standard door stiffener |
| 4 | C/W Standard inner panel (Included) |
| 5 | C/W Standard inner panel mounting studs |
| 6 | C/W R5 Insulation (Installed aluminum visible) |

| No. | Revisions | Date | By/Par |
|-----|-----------|------|--------|
| | | | |
| | | | |
| | | | |
| | | | |
| | | | |
| | | | |

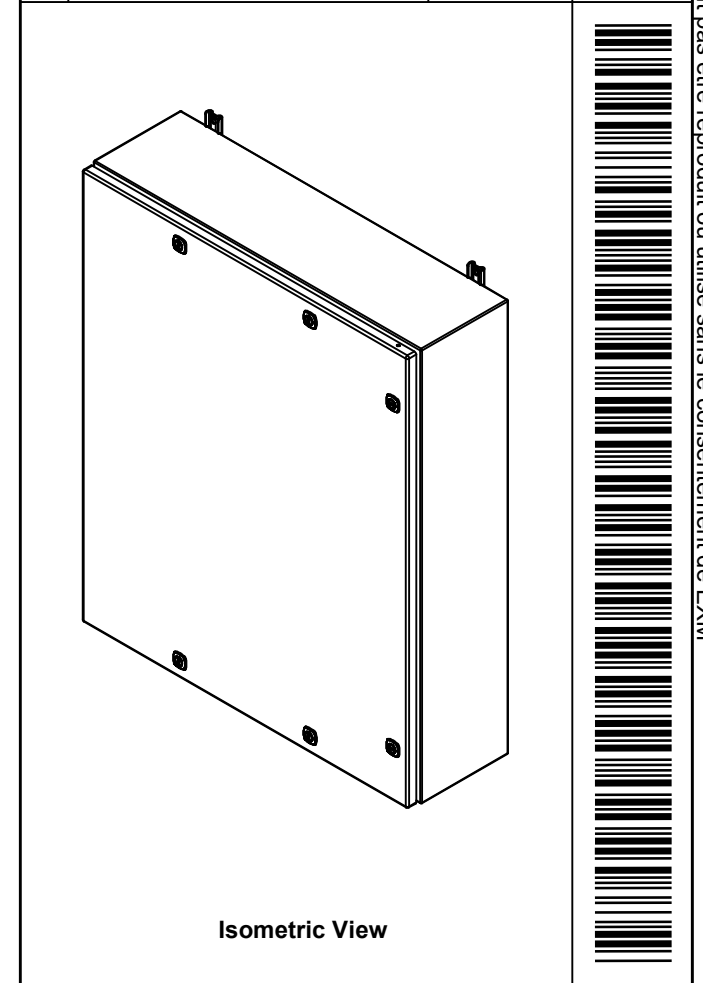

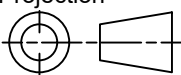
| | |
|--|---|
|  Tél: (450) 979-4373 Fax: (450) 979-4626 www.exmweb.com | Flatness Aplatissement |
| | Max 3.0mm |
| Projection |  |
| Customer Client | Date |
| Drawn By Dessiné Par BoxCad: BoxCad | Date 05-Mar-25 |
| Material Matière 14 Ga Cold Rolled A1008 CS Type B (1.7mm) | |

| PACKING | | |
|-----------------------|-----|--|
| ITEM | QTY | DESCRIPTION |
| Cardboard sleeve | 2 | Top and Bottom |
| Cardboard strip | 2 | Between back of enclosure and inner panel |
| Plastic bag | 1 | To protect cover surface and inside gasket |
| Plastic strap - Black | 2 | To Squeeze the 2 cardboard sleeve together |
| Packaging label | 1 | White label with product number |

| Qty | Part Number | Rev | Description |
|------------|-------------------|-----|--|
| 6 | STK-Q-00600 | 2 | M12 to M8 Adaptor |
| 1 | 881 SP3630G | 0 | 881 SP - Inner Panel |
| 1 | STK-K-01800 | 5 | 5412 ES Accessory Kit |
| 1 | 5412ESPR363008THC | 0 | 5412ESPR 36" x 30" Cover |
| 1 | 5412ESPR363008THB | 0 | 5412ESPR 36" x 30" x 8" Body |
| 6 | STK-Q-04050-08 | 0 | M6 x 8mm Hexagon Socket Head Machine Screw |
| Parts List | | | |

| | | | |
|-----------------------------|----------------------------------|----------------|--------|
| Color Couleur | Asa-61 Grey | Finish Fini | Smooth |
| Description | 5412ESPR 36" x 30" x 8" Assembly | | |
| Part Number Numéro Pièce | 5412ESPR363008TH | | Rev. 2 |
| | | | 0 |
| | | | 16 |

This drawing is confidential and must not be reproduced or used without the consent of EXM

Ce dessin est confidentiel et ne doit pas être reproduit ou utilisé sans le consentement de EXM

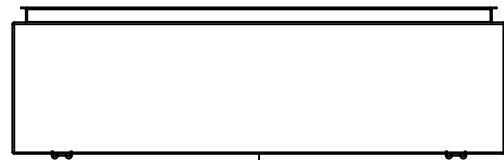

TOP

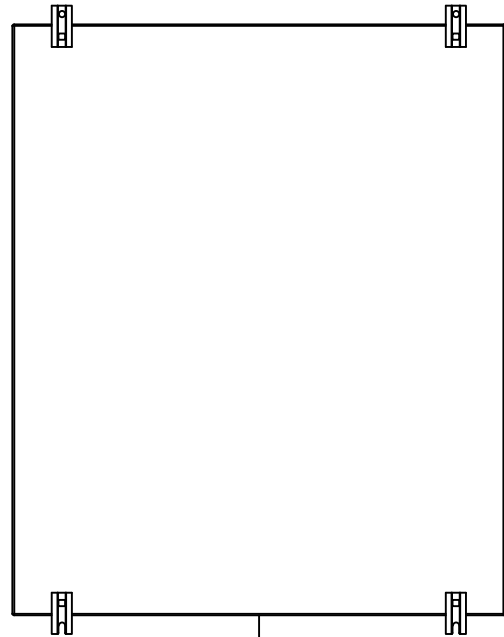

BACK

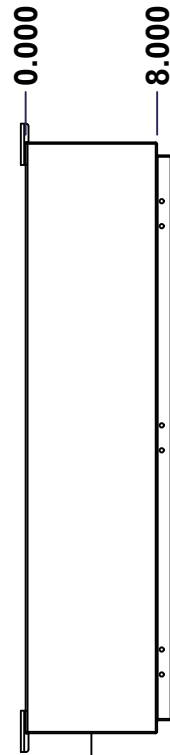

LEFT

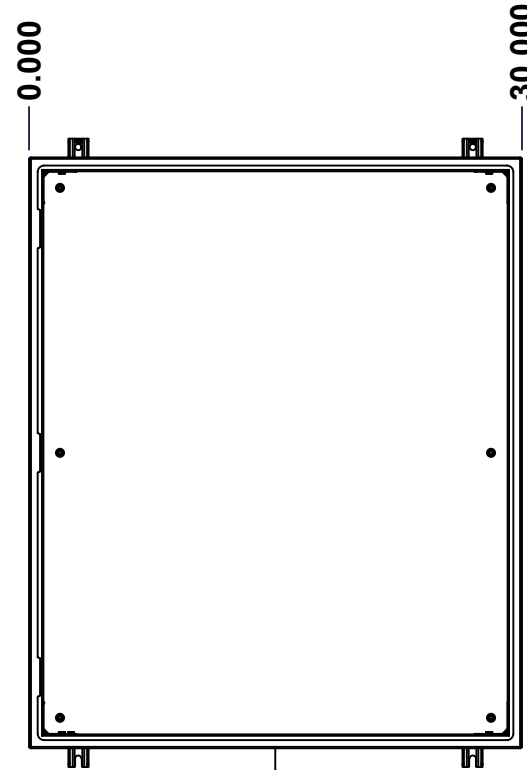

FRONT

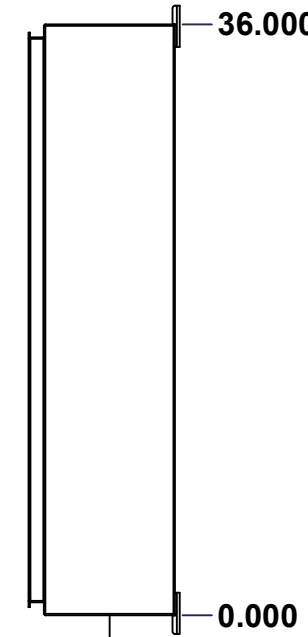

RIGHT

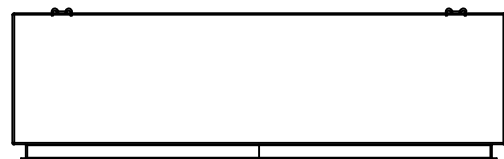

BOTTOM

| No. | Revisions | Date | By/Par |
|-----|-----------|------|--------|
| | | | |
| | | | |
| | | | |
| | | | |

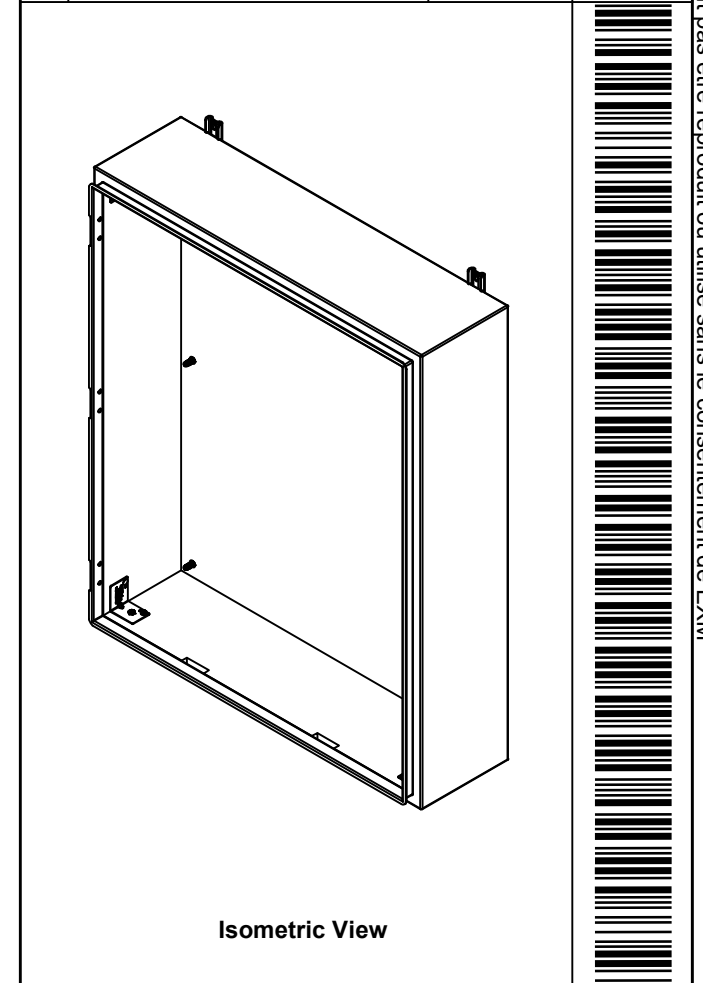

Isometric View

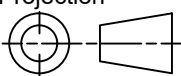

| | | |
|--|---|---|
|  Tél: (450) 979-4373 Fax: (450) 979-4626 www.exmweb.com | | Flatness Aplatissement Max 3.0mm Projection  |
| Customer Client | Date | |
| Drawn By Dessiné Par | BoxCad: BoxCad | Date 05-Mar-25 |
| Material Matière | 14 Ga Cold Rolled A1008 CS Type B (1.7mm) | |
| Color Couleur | Asa-61 Grey | Finish Fini Smooth |
| Description | Detail Rev. | |
| 5412ESPR 36" x 30" x 8" Body | | |
| Part Number Numéro Pièce | Rev. 0 | 3 / 16 |

SEE BILL OF MATERIAL ON LAST PAGE

5412ESPR363008THB

This drawing is confidential and must not be reproduced or used without the consent of EXM

Ce dessin est confidentiel et ne doit pas être reproduit ou utilisé sans le consentement de EXM

| STANDARD FEATURES ARE NOT LISTED IN THIS HOLE TABLE | | | |
|---|--------|-------|--------------------------------|
| HOLE TABLE - TOP VIEW (CUSTOM FEATURE ONLY) | | | |
| CUT-OUT | XDIM | YDIM | DESCRIPTION |
| 1 | 2.000 | 6.500 | INSUL. STUD M6 x 18mm (Inside) |
| 2 | 28.000 | 6.500 | INSUL. STUD M6 x 18mm (Inside) |

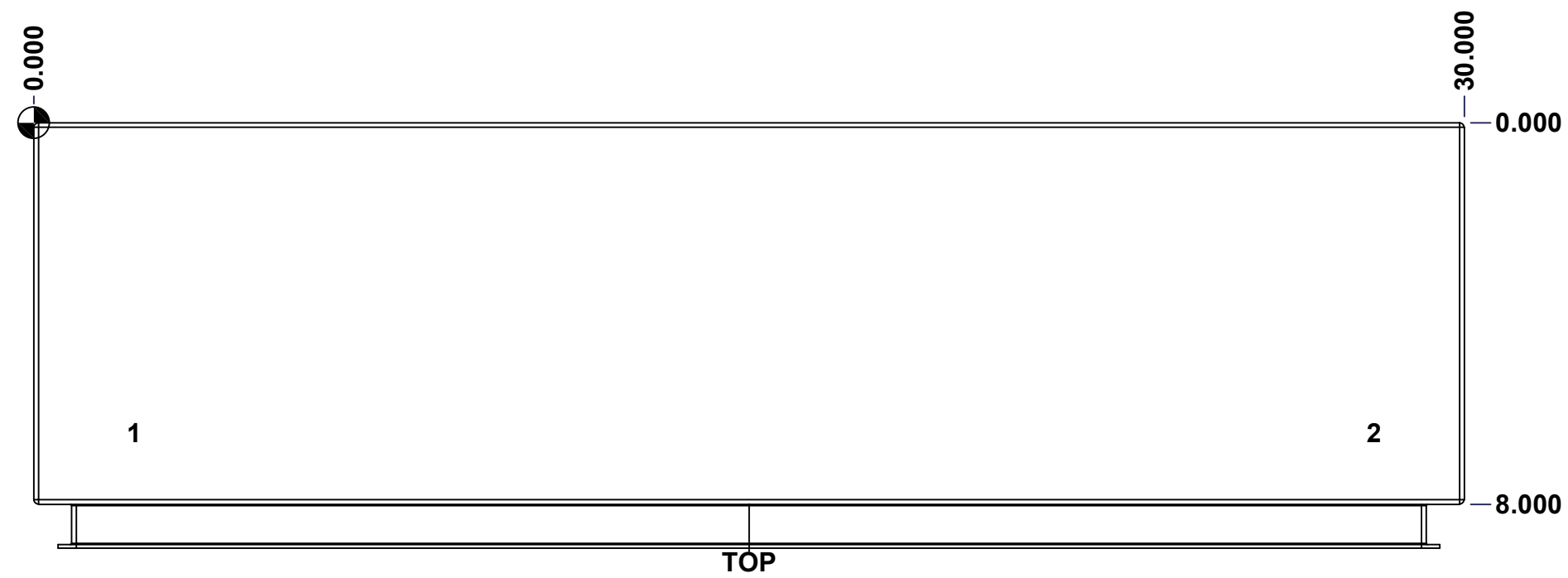

| | | |
|--|------------------------------|--------------|
| | Description | Status |
| | 5412ESPR 36" x 30" x 8" Body | (NULL) |
| | Part Number Numéro Pièce | Rev. |
| | 5412ESPR363008THB | 0 / 4 |
| | | 16 |

This drawing is confidential and must not be reproduced or used without the consent of EXM

Ce dessin est confidentiel et ne doit pas être reproduit ou utilisé sans le consentement de EXM

| STANDARD FEATURES ARE NOT LISTED IN THIS HOLE TABLE | | | |
|--|--------|-------|--------------------------------|
| HOLE TABLE - BOTTOM VIEW (CUSTOM FEATURE ONLY) | | | |
| CUT-OUT | XDIM | YDIM | DESCRIPTION |
| 1 | 2.000 | 6.500 | INSUL. STUD M6 x 18mm (Inside) |
| 2 | 28.000 | 6.500 | INSUL. STUD M6 x 18mm (Inside) |

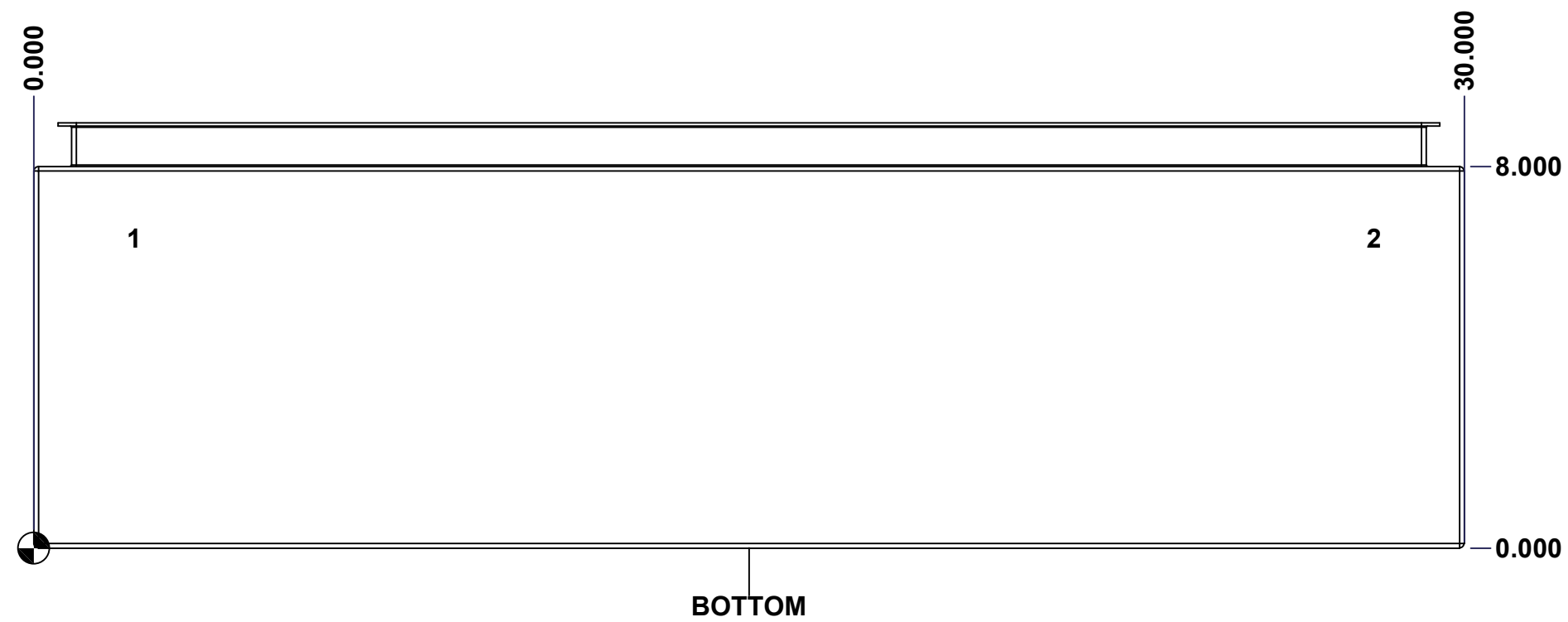

| | | |
|--|------------------------------|--------------|
| | Description | Status |
| | 5412ESPR 36" x 30" x 8" Body | (NULL) |
| | Part Number Numéro Pièce | Rev. |
| | 5412ESPR363008THB | 0 / 5 |
| | | 16 |

This drawing is confidential and must not be reproduced or used without the consent of EXM

Ce dessin est confidentiel et ne doit pas être reproduit ou utilisé sans le consentement de EXM

STANDARD FEATURES ARE NOT LISTED IN THIS HOLE TABLE

HOLE TABLE - BACK VIEW (CUSTOM FEATURE ONLY)

| CUT-OUT | XDIM | YDIM | DESCRIPTION |
|---------|--------|--------|----------------------------|
| 1 | 1.875 | 1.875 | IP STUD M8 x 35mm (Inside) |
| 2 | 1.875 | 34.125 | IP STUD M8 x 35mm (Inside) |
| 3 | 28.125 | 34.125 | IP STUD M8 x 35mm (Inside) |
| 4 | 28.125 | 1.875 | IP STUD M8 x 35mm (Inside) |
| 5 | 1.875 | 18.000 | IP STUD M8 x 35mm (Inside) |
| 6 | 28.125 | 18.000 | IP STUD M8 x 35mm (Inside) |

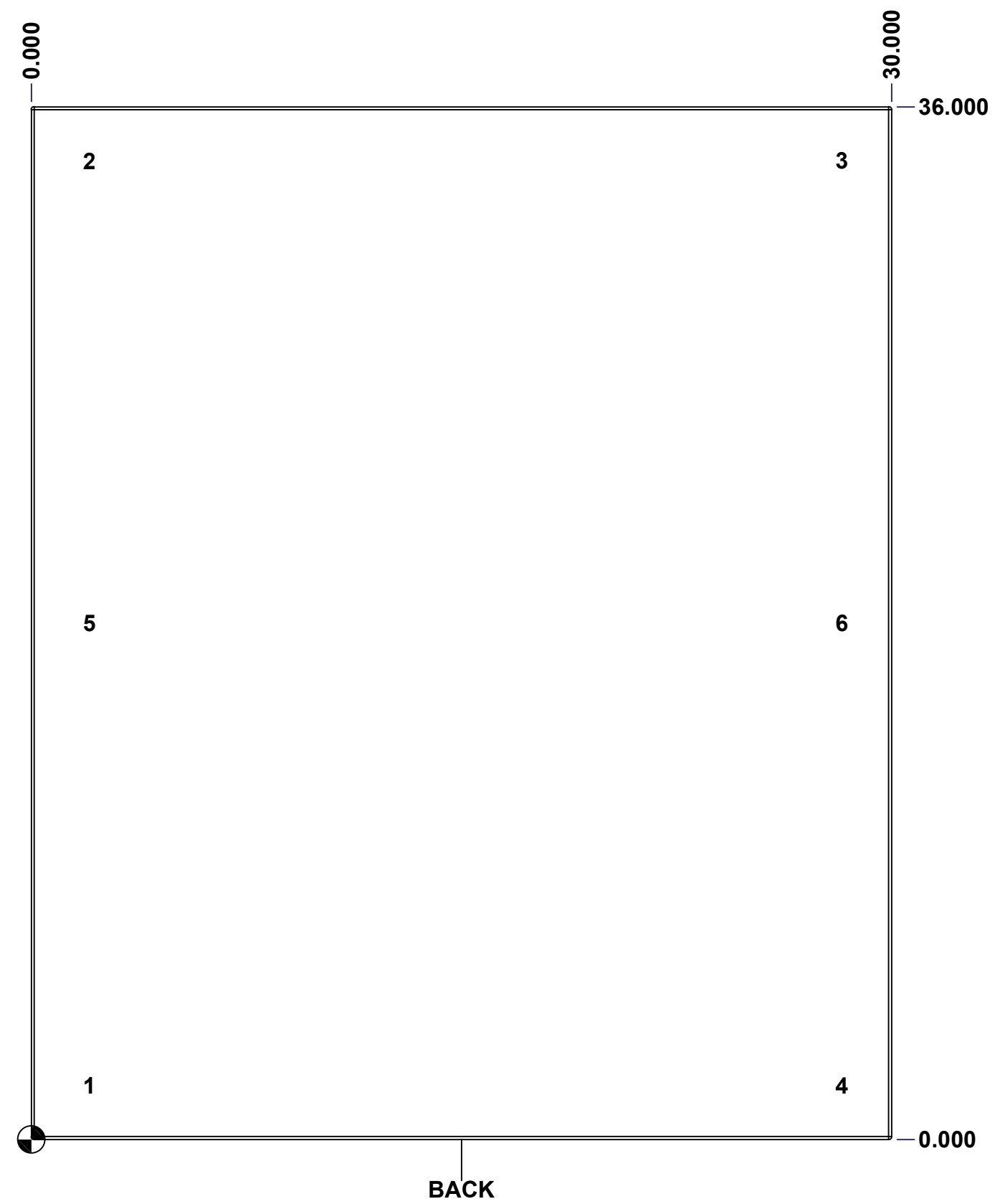

| | | |
|--|------------------------------|--------------|
| | Description | Status |
| | 5412ESPR 36" x 30" x 8" Body | (NULL) |
| | Part Number Numéro Pièce | Rev. |
| | 5412ESPR363008THB | 0 / 6 |
| | | 16 |

This drawing is confidential and must not be reproduced or used without the consent of EXM

Ce dessin est confidentiel et ne doit pas être reproduit ou utilisé sans le consentement de EXM

| No. | Revisions | Date | By/Par |
|-----|-----------|------|--------|
| | | | |
| | | | |
| | | | |
| | | | |
| | | | |

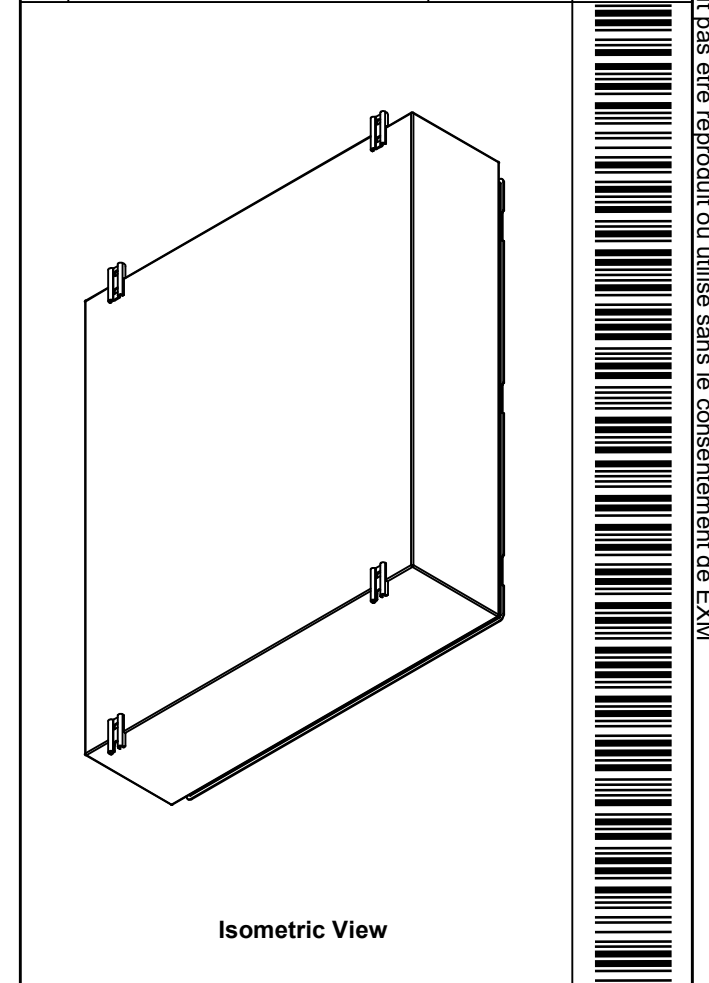

| 1 | STK-K-70554 | 3 | 5412 ESTH Accessory Kit |
|------------|----------------------|-----|--|
| 1 | 5412ESPR363008THI-RS | 0 | 5412ESPR 36" x 30" Right Insulation |
| 1 | 5412ESPR363008THI-LS | 0 | 5412ESPR 36" x 30" Left Insulation |
| 1 | 5412ESPR363008THI-BT | 0 | 5412ESPR 36" x 30"Bottom Insulation |
| 1 | 5412ESPR363008THI-TP | 0 | 5412ESPR 36" x 30"Top Insulation |
| 1 | 5412ESPR363008THI-B | 0 | 5412ESPR 36" x 30" Back Insulation |
| 4 | STK-Q-16055 | 1 | M6 x 18mm Stud (No Paint Cap Required) |
| 2 | 885ESMF3-FEET | 0 | 885 ESMF3 Mounting Foot (Close) |
| 2 | 885ESMF3-FEET-A | 0 | 885 ESMF3 Mounting Foot (Open) |
| 1 | STK-P-02400S | 0 | Powder Paint (Asa-61 Grey / Smooth) |
| 6 | STK-Q-16005 | 0 | Stud M8 x 35mm Steel |
| 1 | 5412ESPR363008THB-P | 0 | 5412ESPR 36" x 30" x 8" Body Part |
| Qty | Part Number | Rev | Description |
| Parts List | | | |

| | | |
|--|---|-----------------------|
| Tél: (450) 979-4373 Fax: (450) 979-4626 www.exmweb.com | Flatness Aplatissement | Max 3.0mm |
| | Projection | |
| Customer Client | Date | |
| Drawn By Dessiné Par | BoxCad: BoxCad | Date 05-Mar-25 |
| Material Matière | 14 Ga Cold Rolled A1008 CS Type B (1.7mm) | |
| Color Couleur | Asa-61 Grey | Finish Fini Smooth |
| Description | Detail Rev. | |
| 5412ESPR 36" x 30" x 8" Body | | |
| Part Number Numéro Pièce | Rev. | 7 |
| 5412ESPR363008THB | 0 | 16 |

This drawing is confidential and must not be reproduced or used without the consent of EXM

Ce dessin est confidentiel et ne doit pas être reproduit ou utilisé sans le consentement de EXM

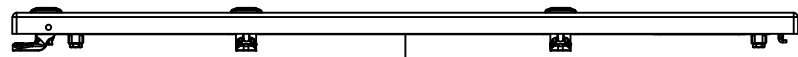

TOP

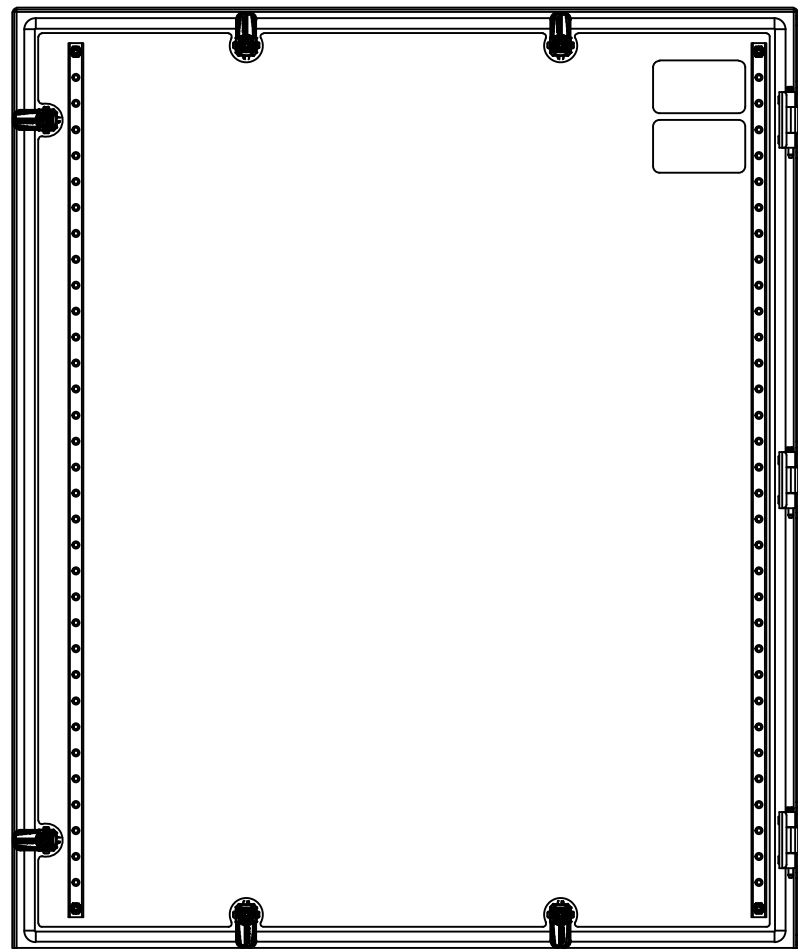

BACK

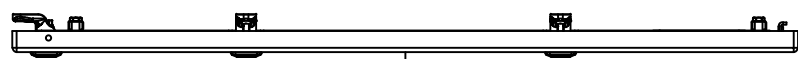

BOTTOM

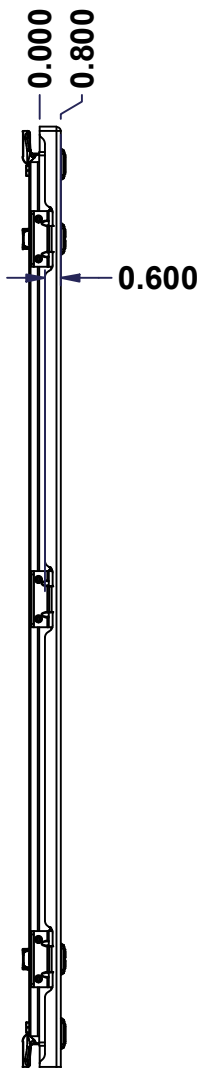

LEFT

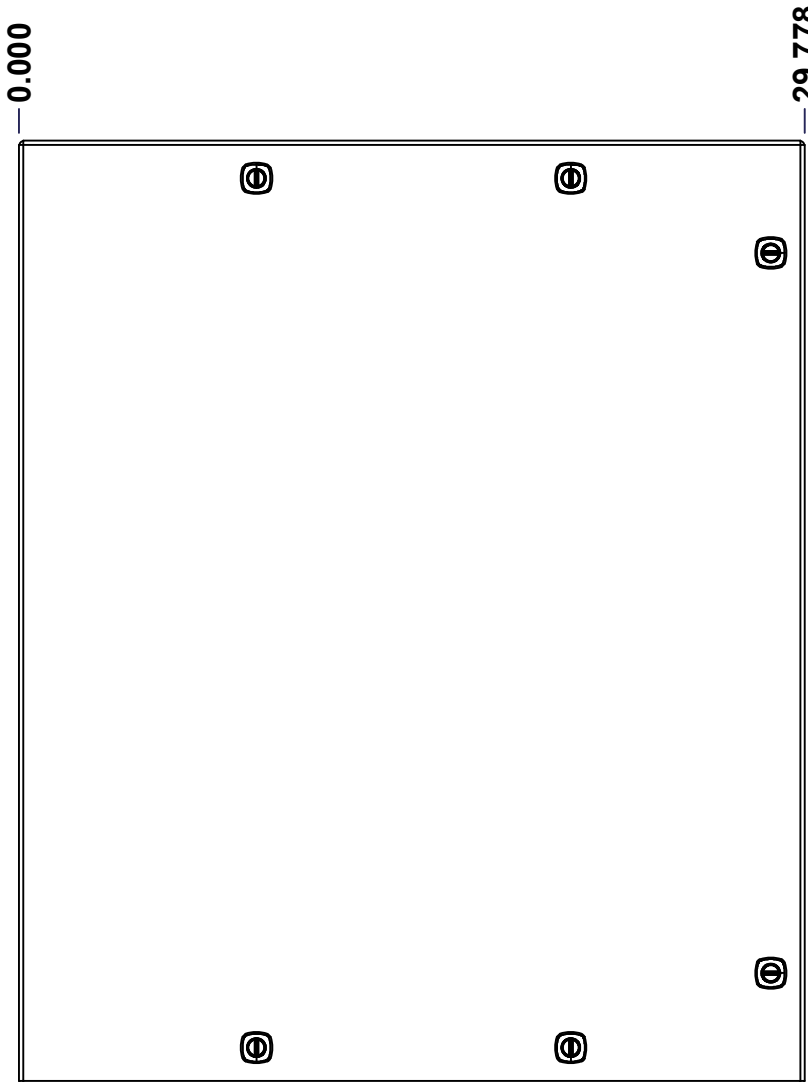

FRONT

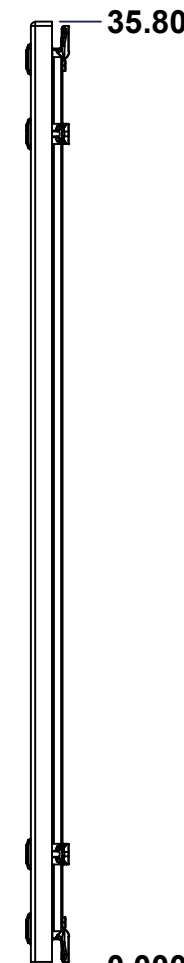

RIGHT

| No. | Revisions | Date | By/Par |
|-----|-----------|------|--------|
| | | | |
| | | | |
| | | | |
| | | | |

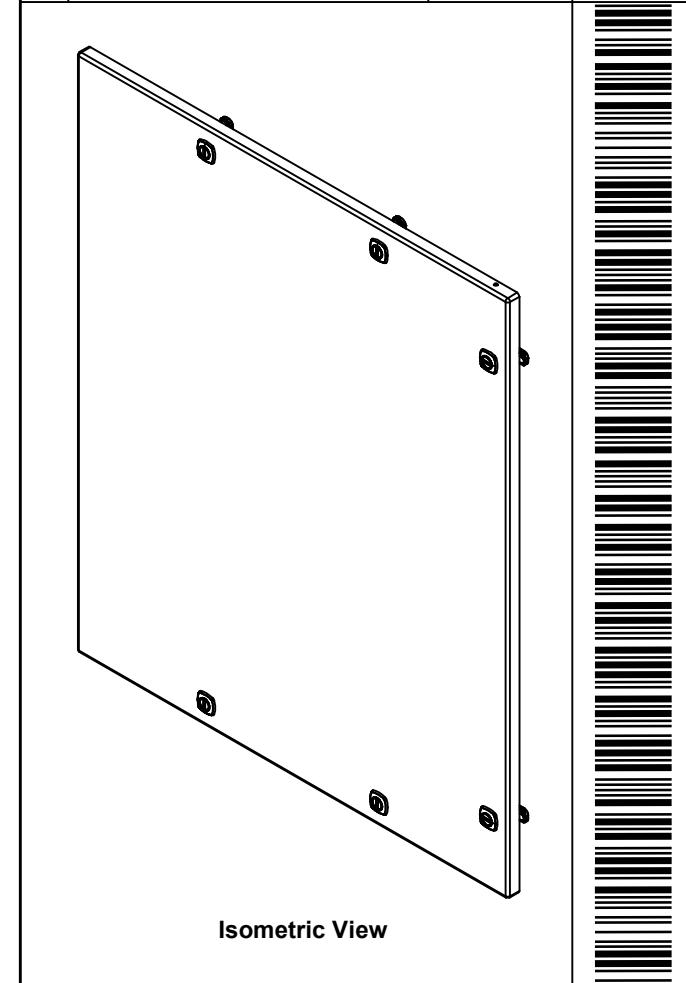

Isometric View

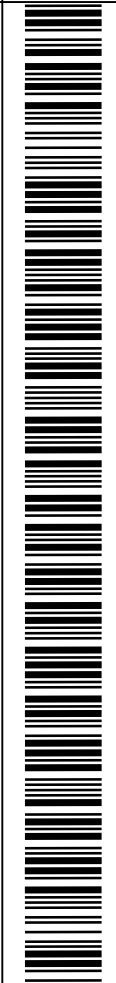

| | | |
|--|---|--|
| Tél: (450) 979-4373 Fax: (450) 979-4626 www.exmweb.com | | Flatness Aplatissement Max 3.0mm Projection |
| Customer Client | Date | |
| Drawn By Dessiné Par | BoxCad: BoxCad | Date 05-Mar-25 |
| Material Matière | 14 Ga Cold Rolled A1008 CS Type B (1.7mm) | |
| Color Couleur | Asa-61 Grey | Finish Fini Smooth |
| Description | Detail Rev. | |
| 5412ESPR 36" x 30" Cover | | |
| Part Number Numéro Pièce | Rev. 0 | 8 / 16 |

SEE BILL OF MATERIAL ON LAST PAGE

5412ESPR363008THC

This drawing is confidential and must not be reproduced or used without the consent of EXM

Ce dessin est confidentiel et ne doit pas être reproduit ou utilisé sans le consentement de EXM

STANDARD FEATURES ARE NOT LISTED IN THIS HOLE TABLE

HOLE TABLE - FRONT VIEW (CUSTOM FEATURE ONLY)

| CUT-OUT | XDIM | YDIM | DESCRIPTION |
|---------|--------|--------|---------------------------|
| 1 | 1.486 | 1.661 | STUD M6 x 18mm (Inside) |
| 2 | 1.486 | 34.142 | STUD M6 x 18mm (Inside) |
| 3 | 27.377 | 34.142 | STUD M6 x 18mm (Inside) |
| 4 | 27.377 | 1.661 | STUD M6 x 18mm (Inside) |
| ----- | | | |
| 5 | 28.494 | 31.553 | LOCK 880 SCQ4-SL @ 0.0° |
| 6 | 28.494 | 4.250 | LOCK 880 SCQ4-SL @ 0.0° |
| 7 | 9.000 | 34.379 | LOCK 880 SCQ4-SL @ 90.0° |
| 8 | 20.918 | 34.379 | LOCK 880 SCQ4-SL @ 90.0° |
| 9 | 9.000 | 1.424 | LOCK 880 SCQ4-SL @ 270.0° |
| 10 | 20.918 | 1.424 | LOCK 880 SCQ4-SL @ 270.0° |

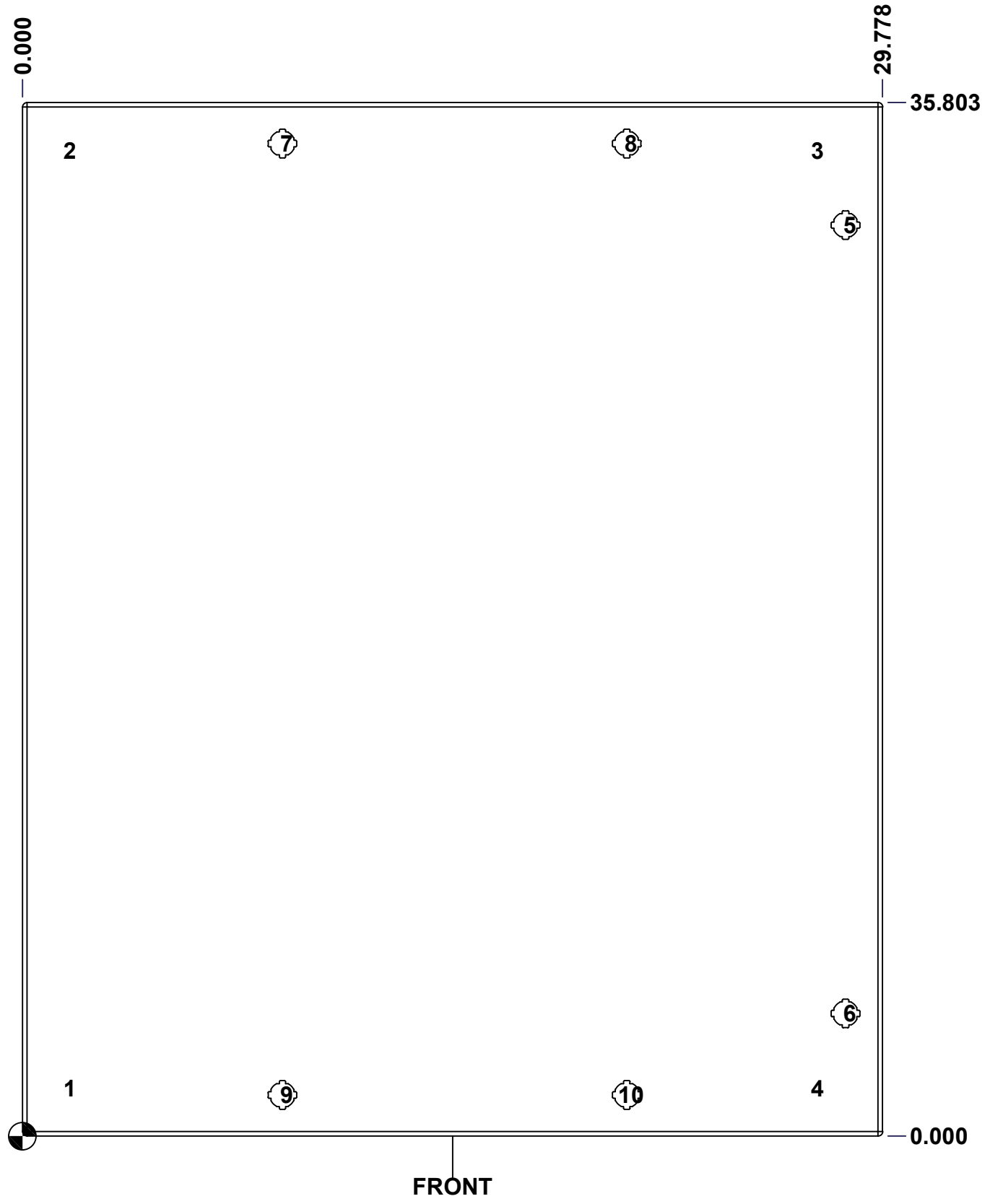

FRONT

| | | |
|--|-----------------------------|----------|
| | Description | Status |
| | 5412ESPR 36" x 30" Cover | (NULL) |
| | Part Number Numéro Pièce | Rev. |
| | 5412ESPR363008THC | 0 |
| | | 9 |
| | | 16 |

This drawing is confidential and must not be reproduced or used without the consent of EXM

Ce dessin est confidentiel et ne doit pas être reproduit ou utilisé sans le consentement de EXM

| No. | Revisions | Date | By/Par |
|-----|-----------|------|--------|
| | | | |
| | | | |
| | | | |
| | | | |
| | | | |

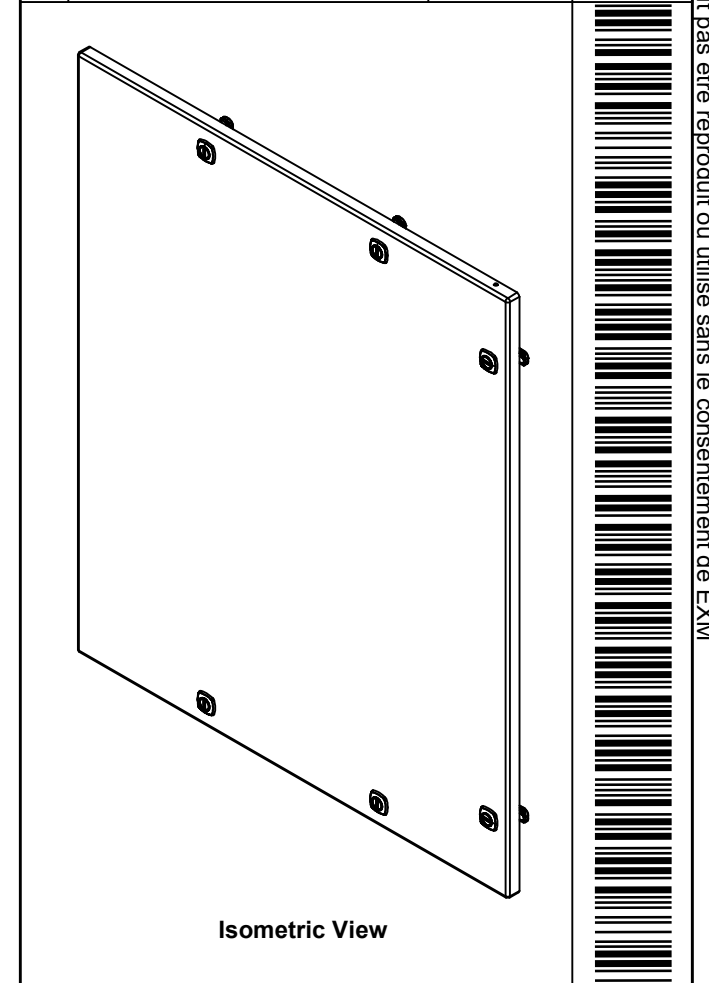

 Tél: (450) 979-4373
 Fax: (450) 979-4626
www.exmweb.com

Flatness
 Aplatissement
 Max 3.0mm
Projection



| | |
|---|-----------------------|
| Customer Client | Date |
| Drawn By Dessiné Par BoxCad: BoxCad | Date 05-Mar-25 |
| Material Matière 14 Ga Cold Rolled A1008 CS Type B (1.7mm) | |
| Color Couleur Asa-61 Grey | Finish Fini Smooth |

| | |
|-----------------------------|-------------|
| Description | Detail Rev. |
| 5412ESPR 36" x 30" Cover | |
| Part Number Numéro Pièce | Rev. 10 |
| 5412ESPR363008THC | 0 16 |

| QTY | Part Number | Rev | Description |
|------------|---------------------|-----|--|
| 6 | STK-K-12500 | 19 | 5412 ES 1/4 Turn Lock |
| 2 | STK-S-00100 | 0 | 3.5" x 2" Silver Milar Flexcon Sticker |
| 4 | STK-Q-07250 | 2 | M6 x 16mm Collar Nut |
| 2 | STK-Q-46020-36 | 5 | 5412 ES Vertical Door Stiffener 36" |
| 1 | 5412ESPR363008THI-C | 0 | 5412ESPR 36" x 30" Cover Insulation |
| 4 | STK-Q-16055 | 1 | M6 x 18mm Stud (No Paint Cap Required) |
| 1 | 5412ESPR363008THG | 0 | 5412ESPR 36" x 30" Cover Gasket Part |
| 1 | 5412ESPR363008THC-P | 0 | 5412ESPR 36" x 30" Cover Part |
| 3 | STK-A-33005PR | 1 | 5412 ESPR Hinge 180° (Body Part) |
| Parts List | | | |

This drawing is confidential and must not be reproduced or used without the consent of EXM

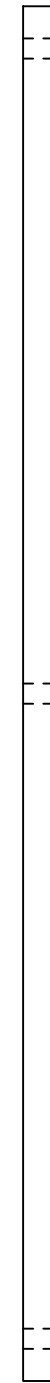
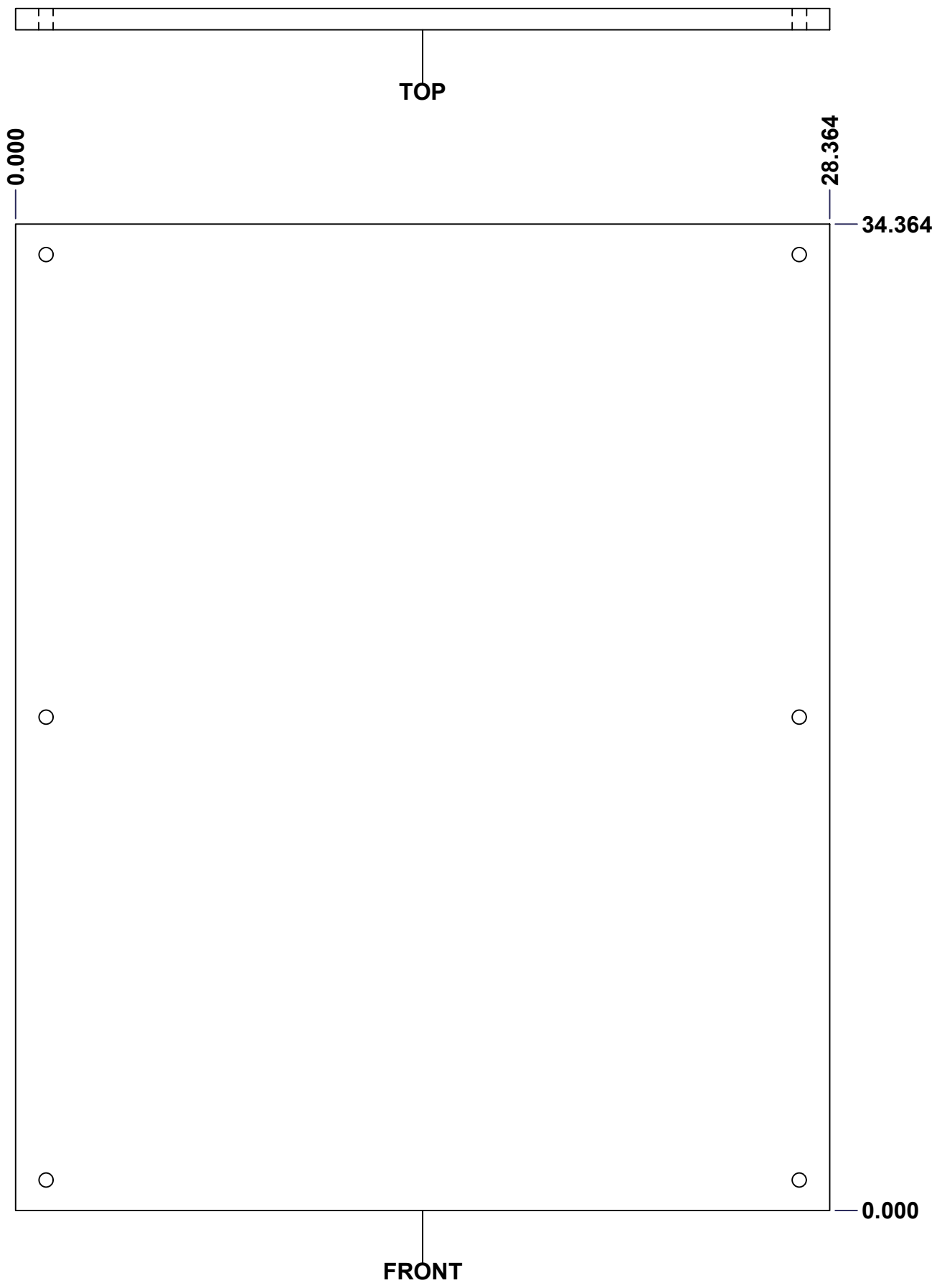
Ce dessin est confidentiel et ne doit pas être reproduit ou utilisé sans le consentement de EXM



| No. | Revisions | Date | By/Par |
|-----|-----------|------|--------|
| | | | |
| | | | |
| | | | |
| | | | |
| | | | |

Isometric View

| | | | |
|---|--|---------------------------|----------------|
| <p>Tél: (450) 979-4373 Fax: (450) 979-4626 www.exmweb.com</p> | | Flatness Aplatissement | |
| | | Max 3.0mm | |
| Customer Client | | Date | |
| Drawn By Dessiné Par | | Date | |
| Material Matière | | Polyisocyanurate | |
| Color Couleur | | Aluminum | Finish Fini |
| Description | | Detail Rev. | |
| Part Number Numéro Pièce | | Rev. | 11 |
| 5412ESPR363008THI-B | | 0 | 16 |

SEE BILL OF MATERIAL ON LAST PAGE

This drawing is confidential and must not be reproduced or used without the consent of EXM

Ce dessin est confidentiel et ne doit pas être reproduit ou utilisé sans le consentement de EXM

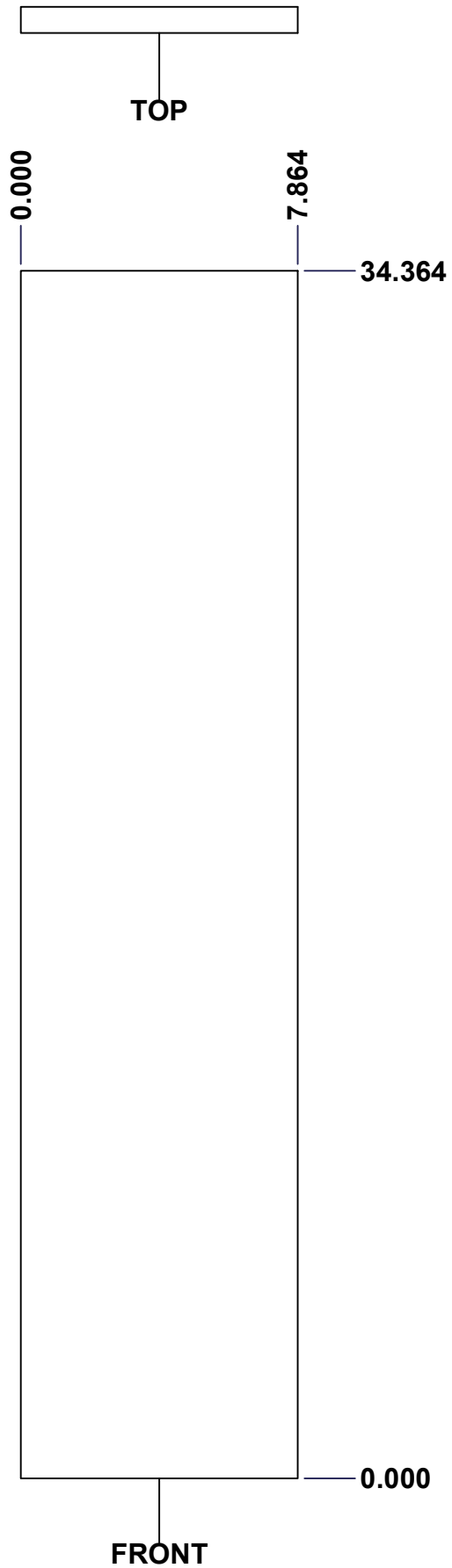

| No. | Revisions | Date | By/Par |
|-----|-----------|------|--------|
| | | | |
| | | | |
| | | | |
| | | | |
| | | | |

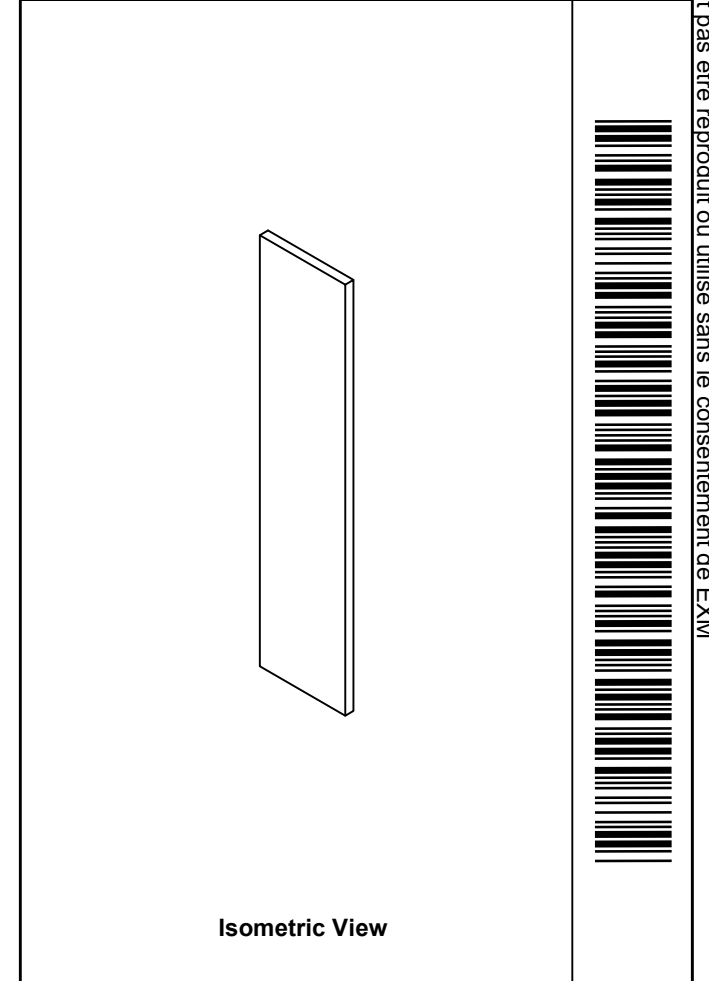

Isometric View

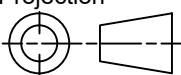
| | | |
|--|---------------------------|--|
|  Tél: (450) 979-4373 Fax: (450) 979-4626 www.exmweb.com | | Flatness Aplatissement Max 3.0mm |
| Projection  | | Date 23-Jan-07 |
| Customer Client | Date | |
| Drawn By Dessiné Par | BoxCad: Patrick Deschenes | Date 23-Jan-07 |
| Material Matière | Polyisocyanurate | |
| Color Couleur | Aluminum | Finish Fini N/A |
| Description | Detail Rev. | |
| 5412ESPR 36" x 30" Left Insulation | | |
| Part Number Numéro Pièce | Rev. | 12 |
| 5412ESPR363008TH-LS | 0 | 16 |

SEE BILL OF MATERIAL ON LAST PAGE

This drawing is confidential and must not be reproduced or used without the consent of EXM

Ce dessin est confidentiel et ne doit pas être reproduit ou utilisé sans le consentement de EXM

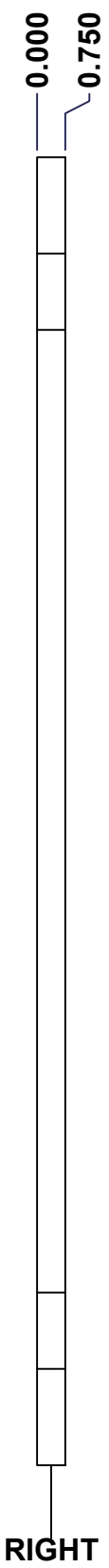
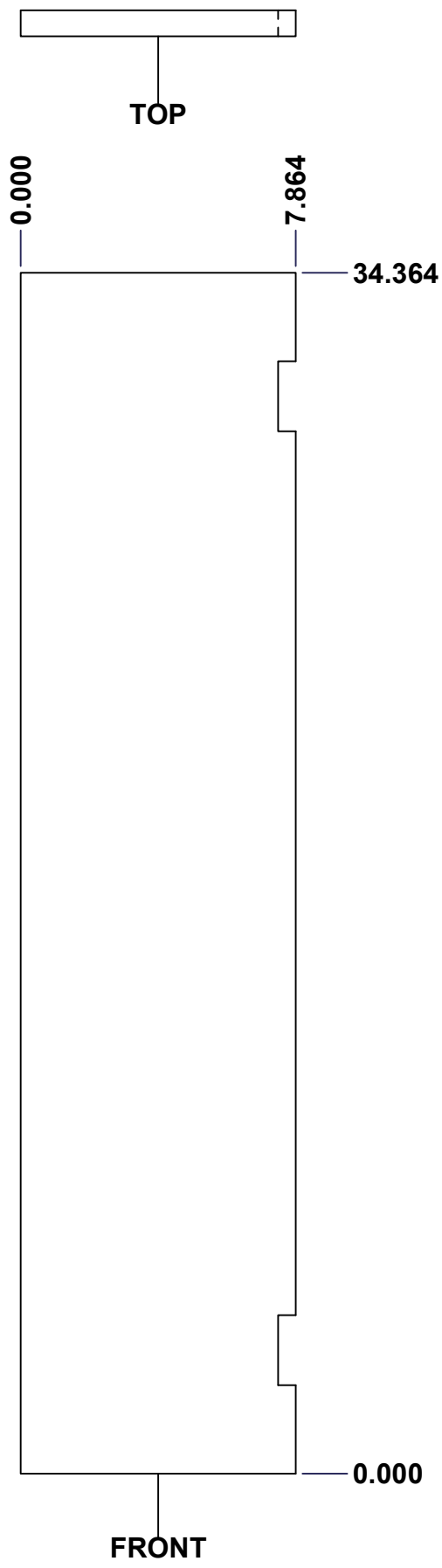

| No. | Revisions | Date | By/Par |
|-----|-----------|------|--------|
| | | | |
| | | | |
| | | | |
| | | | |
| | | | |

Isometric View

| | | |
|--|---------------------------|--|
| Tél: (450) 979-4373 Fax: (450) 979-4626 www.exmweb.com | | Flatness Aplatissement Max 3.0mm |
| Projection | | Date 23-Jan-07 |
| Customer Client | Date | |
| Drawn By Dessiné Par | BoxCad: Patrick Deschenes | Date 23-Jan-07 |
| Material Matière | Polyisocyanurate | |
| Color Couleur | Aluminum | Finish Fini N/A |
| Description 5412ESPR 36" x 30" Right Insulation | | Detail Rev. |
| Part Number Numéro Pièce | | Rev. |
| 5412ESPR363008THI-RS | | 13 0 |
| SEE BILL OF MATERIAL ON LAST PAGE | | 16 |

This drawing is confidential and must not be reproduced or used without the consent of EXM

Ce dessin est confidentiel et ne doit pas être reproduit ou utilisé sans le consentement de EXM

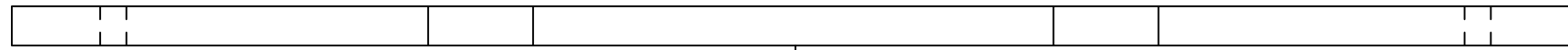

TOP

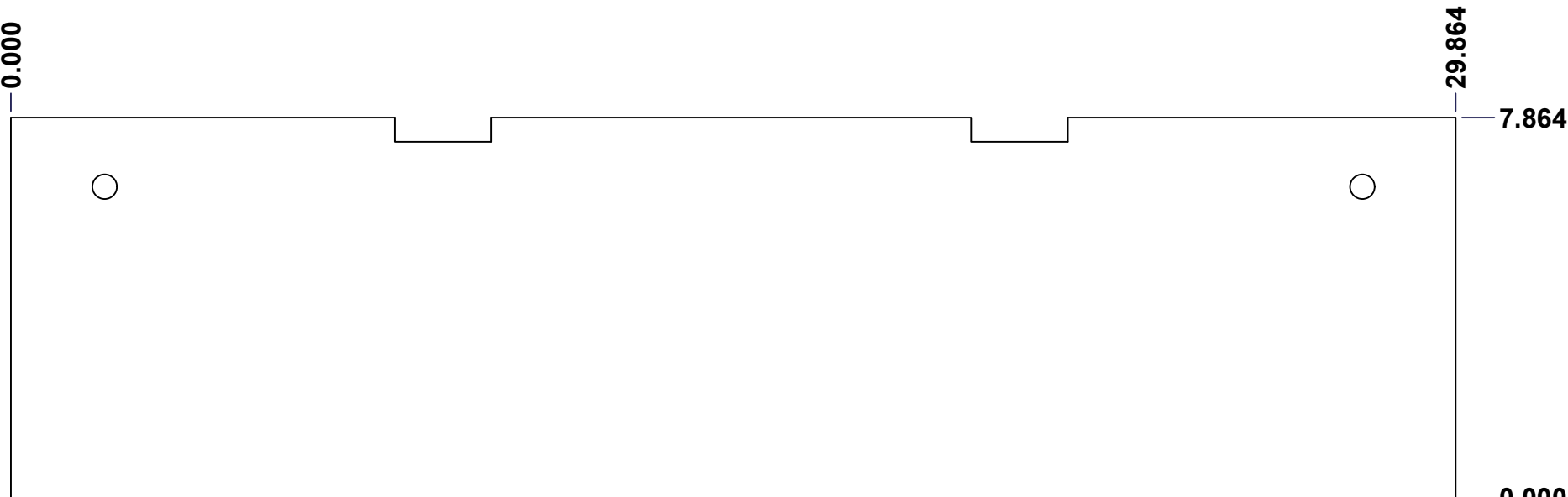

FRONT



RIGHT

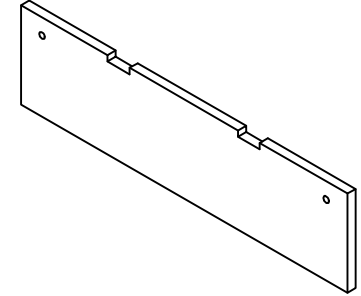

Isometric View

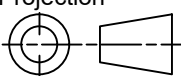

| No. | Revisions | Date | By/Par |
|-----|-----------|------|--------|
| | | | |
| | | | |
| | | | |
| | | | |
| | | | |

| | | |
|--|------------------|---|
|  Tél: (450) 979-4373 Fax: (450) 979-4626 www.exmweb.com | | Flatness Aplatissement Max 3.0mm Projection  |
| Customer Client | Date | |
| Drawn By Dessiné Par | BoxCad: BoxCad | Date 4/3/2024 |
| Material Matière | Polyisocyanurate | |
| Color Couleur | Aluminum | Finish Fini Smooth |
| Description | Detail Rev. | |
| 5412ESPR 36" x 30"Top Insulation | | |
| Part Number Numéro Pièce | Rev. 0 | 14 16 |

SEE BILL OF MATERIAL ON LAST PAGE

5412ESPR363008THI-TP

This drawing is confidential and must not be reproduced or used without the consent of EXM

Ce dessin est confidentiel et ne doit pas être reproduit ou utilisé sans le consentement de EXM

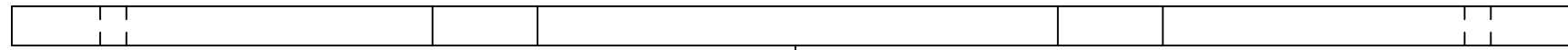

TOP

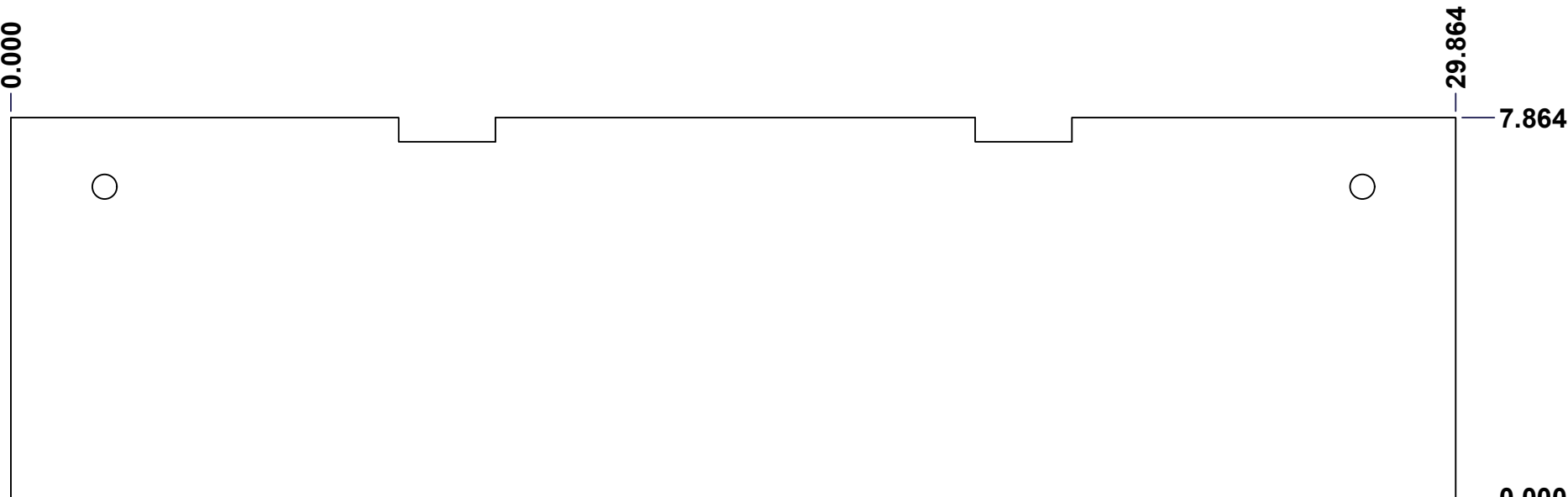



FRONT

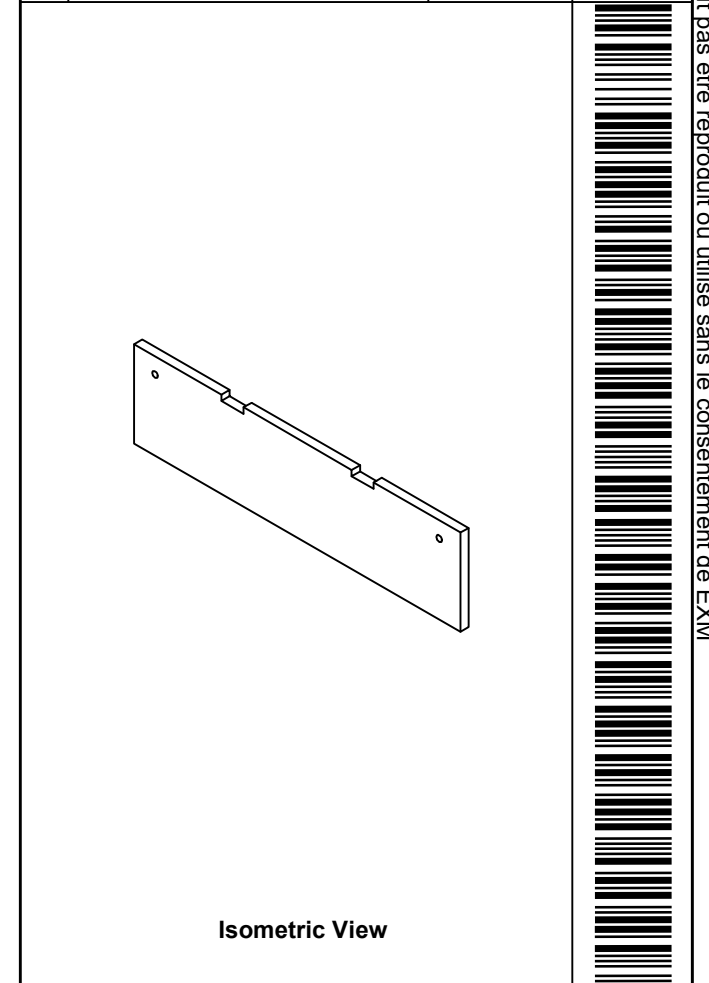

RIGHT

| No. | Revisions | Date | By/Par |
|-----|-----------|------|--------|
| | | | |
| | | | |
| | | | |
| | | | |
| | | | |

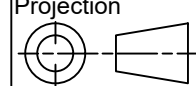

| | |
|--|---|
|  Tél: (450) 979-4373 Fax: (450) 979-4626 www.exmweb.com | Flatness Aplatissement Max 3.0mm |
| | Projection  |
| Customer Client | Date |
| Drawn By Dessiné Par BoxCad: BoxCad | Date 4/3/2024 |
| Material Matière Polyisocyanurate | |
| Color Couleur Aluminum | Finish Fini Smooth |
| Description 5412ESPR 36" x 30"Bottom Insulation | Detail Rev. |
| Part Number Numéro Pièce 5412ESPR363008THI-BT | Rev. 15 0 |

SEE BILL OF MATERIAL ON LAST PAGE

This drawing is confidential and must not be reproduced or used without the consent of EXM

Ce dessin est confidentiel et ne doit pas être reproduit ou utilisé sans le consentement de EXM

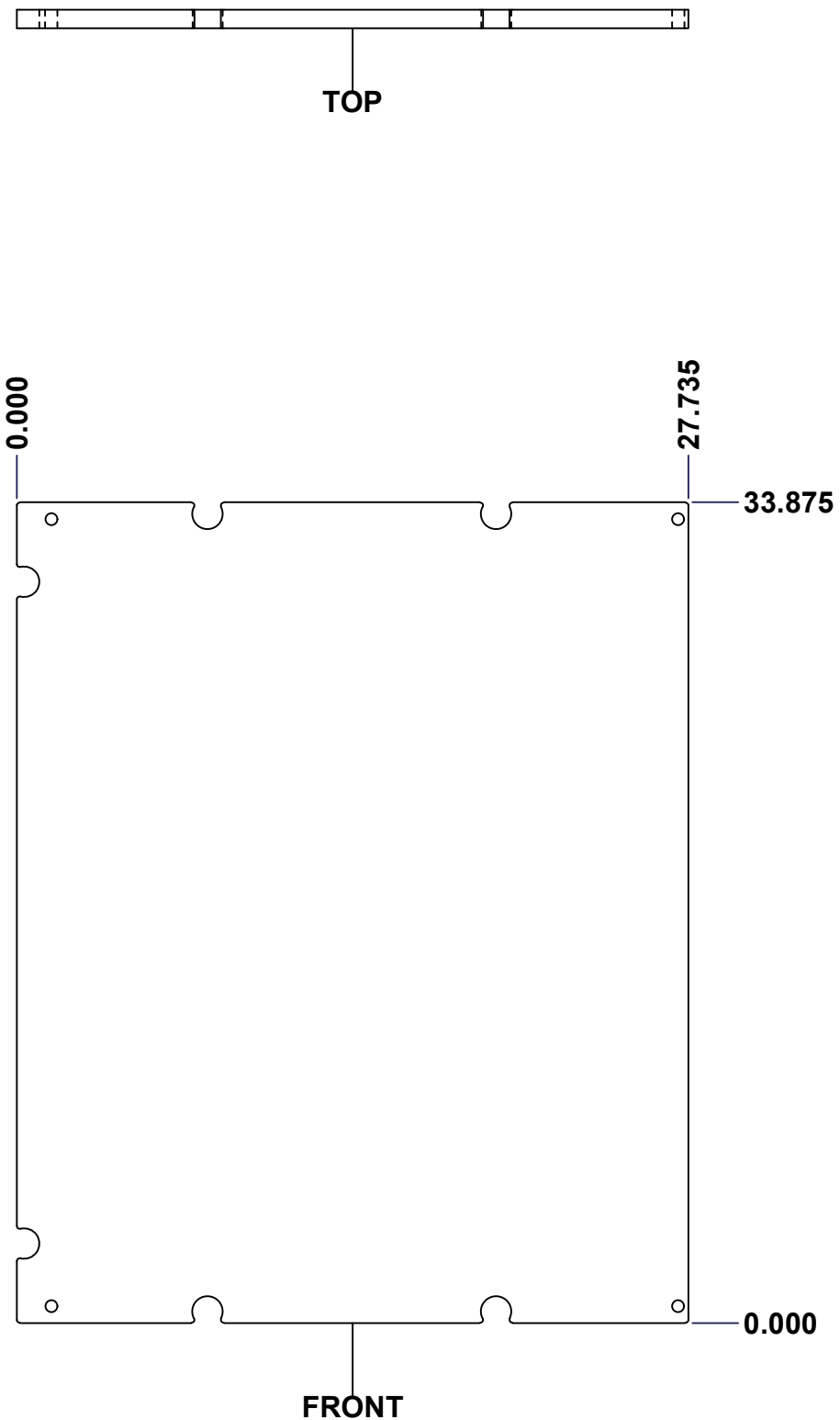

| No. | Revisions | Date | By/Par |
|-----|-----------|------|--------|
| | | | |
| | | | |
| | | | |
| | | | |

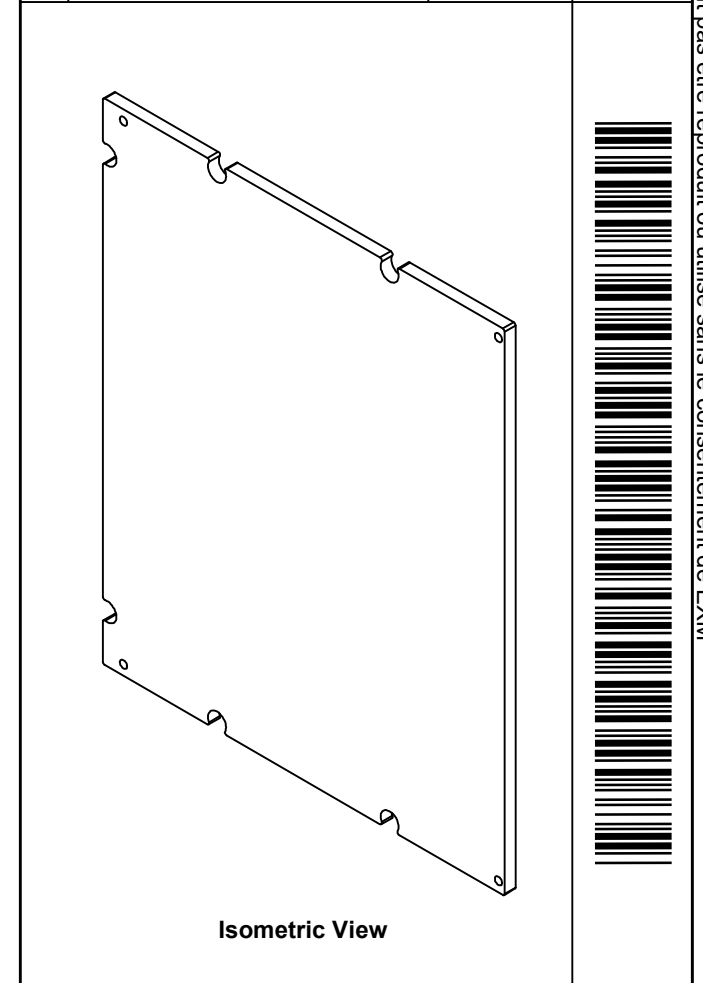

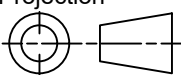
| | | |
|--|---------------------------|---|
|  Tél: (450) 979-4373 Fax: (450) 979-4626 www.exmweb.com | | Flatness Aplatissement Max 3.0mm Projection  |
| Customer Client | Date | |
| Drawn By Dessiné Par | BoxCad: Patrick Deschenes | Date 23-Jan-07 |
| Material Matière | Polyisocyanurate | |
| Color Couleur | Aluminum | Finish Fini N/A |
| Description 5412ESPR 36" x 30" Cover Insulation | | Detail Rev. |
| Part Number Numéro Pièce | Rev. 0 | 16 / 16 |

SEE BILL OF MATERIAL ON LAST PAGE

5412ESPR363008THI-C

This drawing is confidential and must not be reproduced or used without the consent of EXM

Ce dessin est confidentiel et ne doit pas être reproduit ou utilisé sans le consentement de EXM

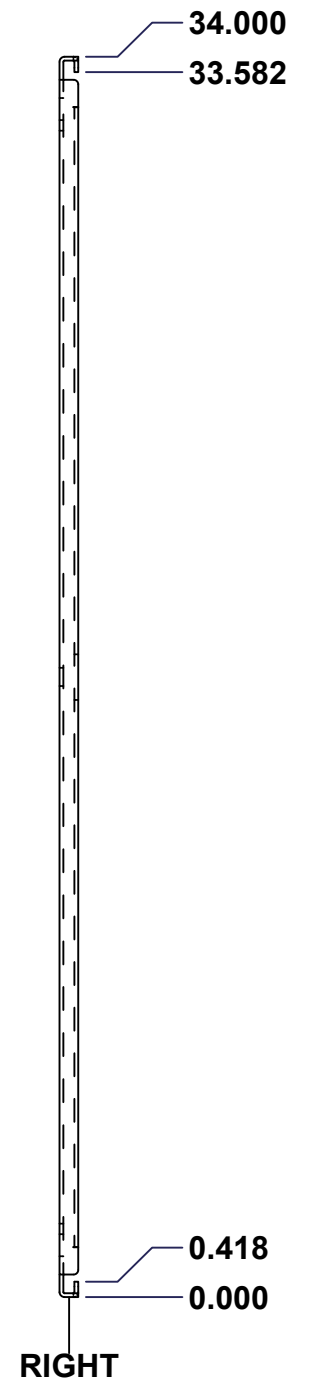
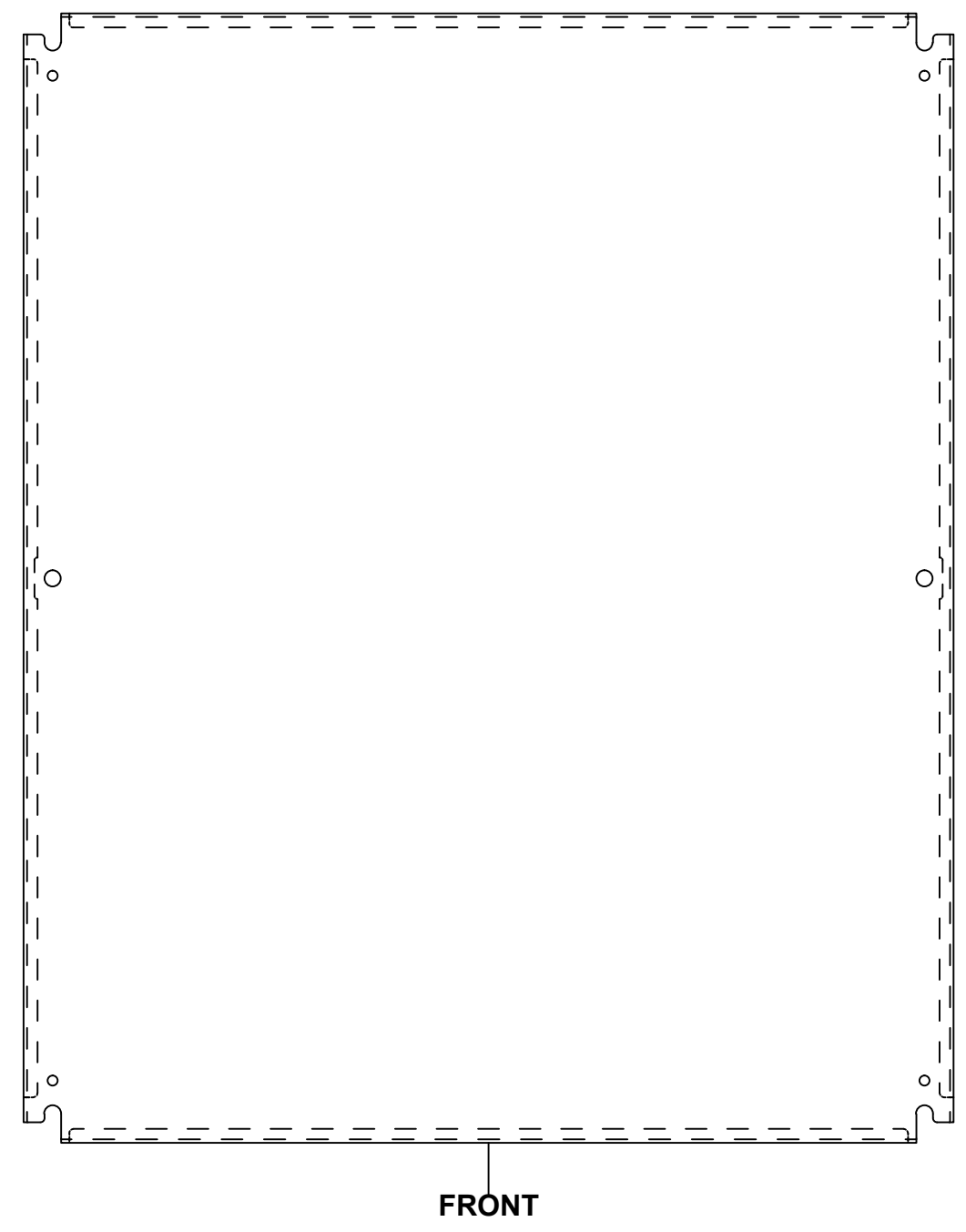
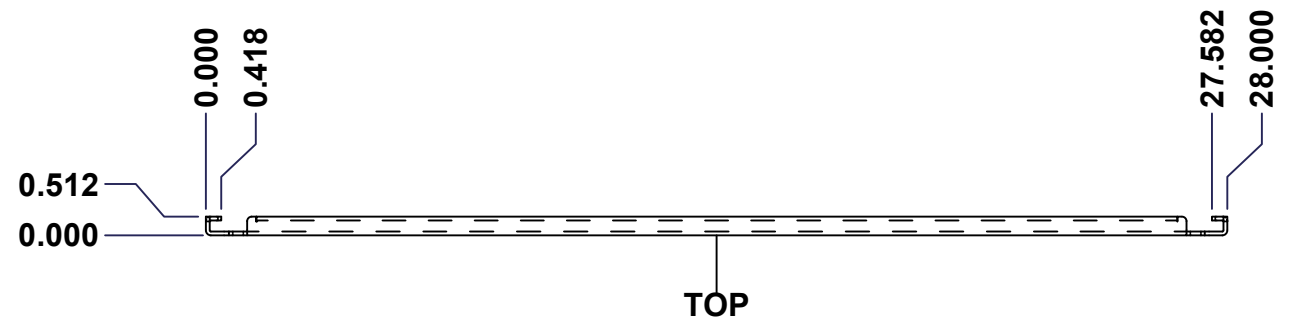

| No. | Revisions | Date | By/Par |
|-----|-----------|------|--------|
| | | | |
| | | | |
| | | | |
| | | | |
| | | | |

Isometric View

| | |
|--|---------------------------|
| Tél: (450) 979-4373 Fax: (450) 979-4626 www.exmweb.com | Flatness Aplatissement |
| | Max 3.0mm |
| Projection | |
| Customer Client | Date |
| Drawn By Dessiné Par BoxCad | Date 23-Jan-07 |
| Material Matière | See Part List |
| Color Couleur | See Part List |
| Finish Fini | See Part List |
| Description | Detail Rev. |
| 881 SP - Inner Panel | |
| Part Number Numéro Pièce | Rev. 1 |
| 881 SP3630G | 0 2 |

| Qty | Part Number | Rev | Description | Material | Color | Finish |
|-----|---------------|-----|---------------------------|------------------|-----------|------------|
| 1 | 881 SP3630G-P | 0 | 881 SP - Inner Panel Part | 12 Ga Galvanized | Unpainted | Galvanized |

Parts List

This drawing is confidential and must not be reproduced or used without the consent of EXM

Ce dessin est confidentiel et ne doit pas être reproduit ou utilisé sans le consentement de EXM

| Table 1 | | | FRONT VIEW |
|---------|--------|--------|----------------------------|
| CUT-OUT | XDIM | YDIM | DESCRIPTION |
| 1 | 0.875 | 1.875 | GROUND HOLE (RND Ø0.290) |
| 2 | 27.125 | 1.875 | GROUND HOLE (RND Ø0.290) |
| 3 | 0.875 | 32.125 | GROUND HOLE (RND Ø0.290) |
| 4 | 27.125 | 32.125 | GROUND HOLE (RND Ø0.290) |
| 5 | 0.875 | 17.000 | MTG STUD HOLE (RND Ø0.500) |
| 6 | 27.125 | 17.000 | MTG STUD HOLE (RND Ø0.500) |

All knockouts are actual size / Les disques défonçables sont grandeur réel

| No. | Revisions | Date | By/Par |
|-----|-----------|------|--------|
| | | | |
| | | | |
| | | | |
| | | | |
| | | | |
| | | | |



| | | |
|--|--|--|
| | Tél: (450) 979-4373 Fax: (450) 979-4626 www.exmweb.com | Flatness Aplatissement Max 3.0mm |
| | Projection | Customer Client Date |
| Drawn By Dessiné Par BoxCad | Date 23-Jan-07 | Material Matière See Part List |
| Color Couleur See Part List | Finish Fini See Part List | Description 881 SP - Inner Panel |
| Part Number Numéro Pièce 881 SP3630G | Detail Rev. Rev. 0 | 2 2 |