

This drawing is confidential and must not be reproduced or used without the consent of EXM

Ce dessin est confidentiel et ne doit pas être reproduit ou utilisé sans le consentement de EXM

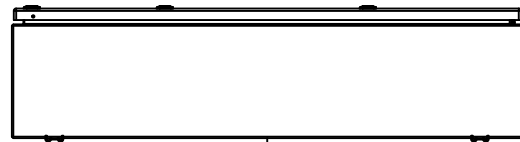

TOP

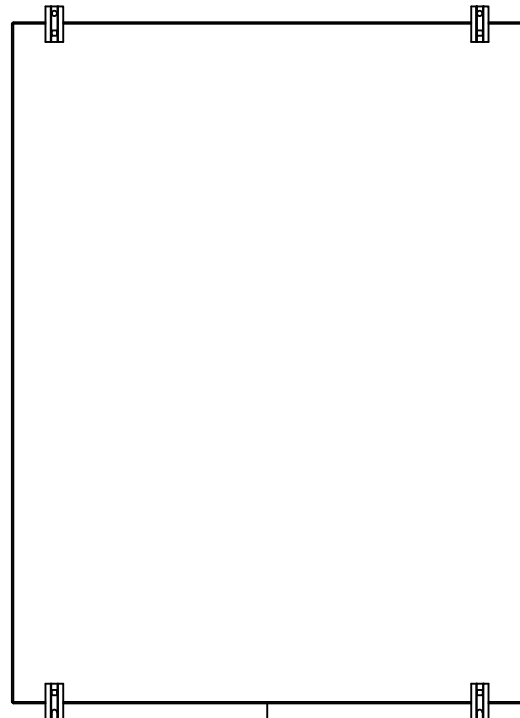

BACK

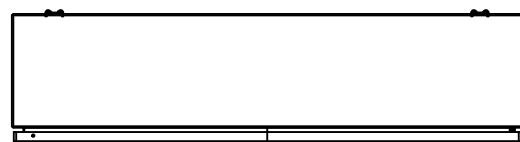

BOTTOM

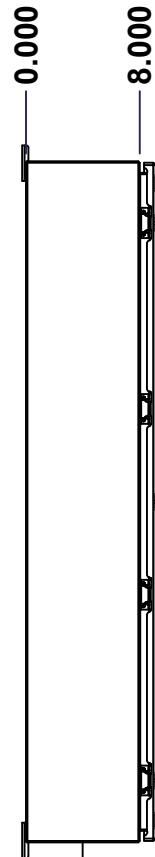

LEFT

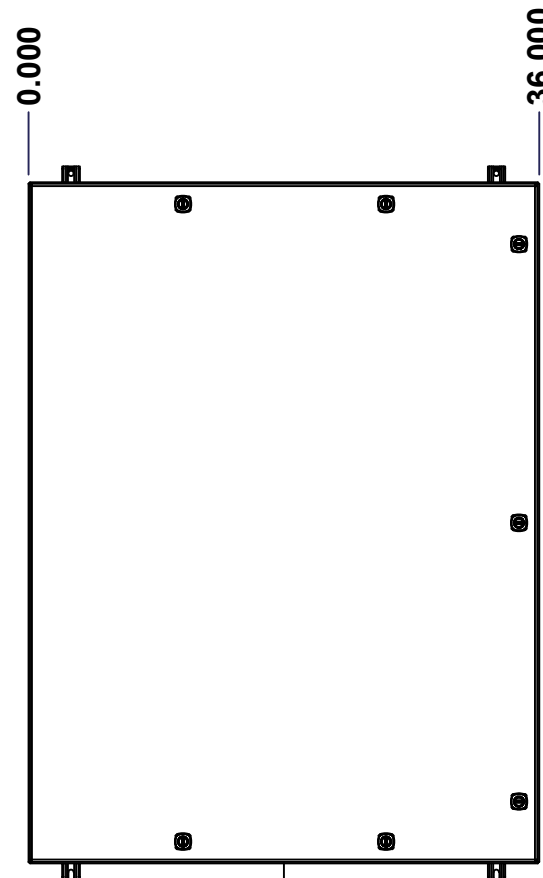

FRONT

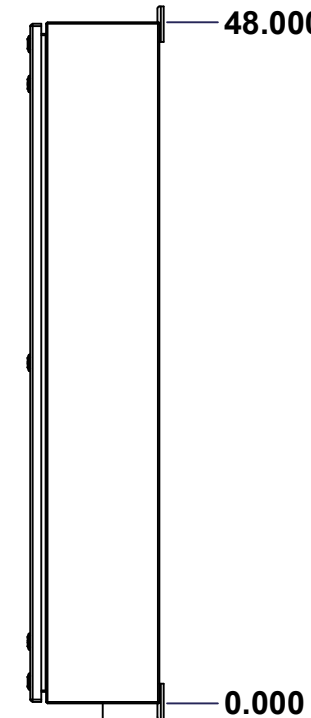

RIGHT

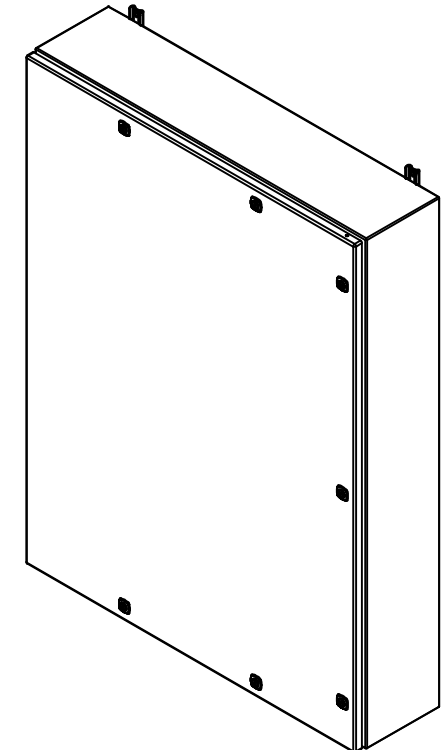

Isometric View

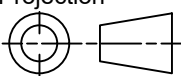

No.	Revisions	Date	By/Par

 Tél: (450) 979-4373 Fax: (450) 979-4626 www.exmweb.com		Flatness Aplatissement Max 3.0mm Projection 
Customer Client	Date	
Drawn By Dessiné Par	BoxCad: BoxCad	Date 10-Mar-25
Material Matière	14 Ga Cold Rolled A1008 CS Type B (1.7mm)	
Color Couleur	Asa-61 Grey	Finish Fini Smooth
Description	Detail Rev.	
5412ESPR 48" x 36" x 8" Assembly		
Part Number Numéro Pièce	Rev.	1
5412ESPR483608TH	0	16

SEE BILL OF MATERIAL ON LAST PAGE

This drawing is confidential and must not be reproduced or used without the consent of EXM

Ce dessin est confidentiel et ne doit pas être reproduit ou utilisé sans le consentement de EXM

NOTE	
ITEM	DESCRIPTION
1	NEMA 4, 12 Enclosure (IP66)
2	C/W Standard ground studs on box and cover
3	C/W Standard door stiffener
4	C/W Standard inner panel (Included)
5	C/W Standard inner panel mounting studs
6	C/W R5 Insulation (Installed aluminum visible)

No.	Revisions	Date	By/Par

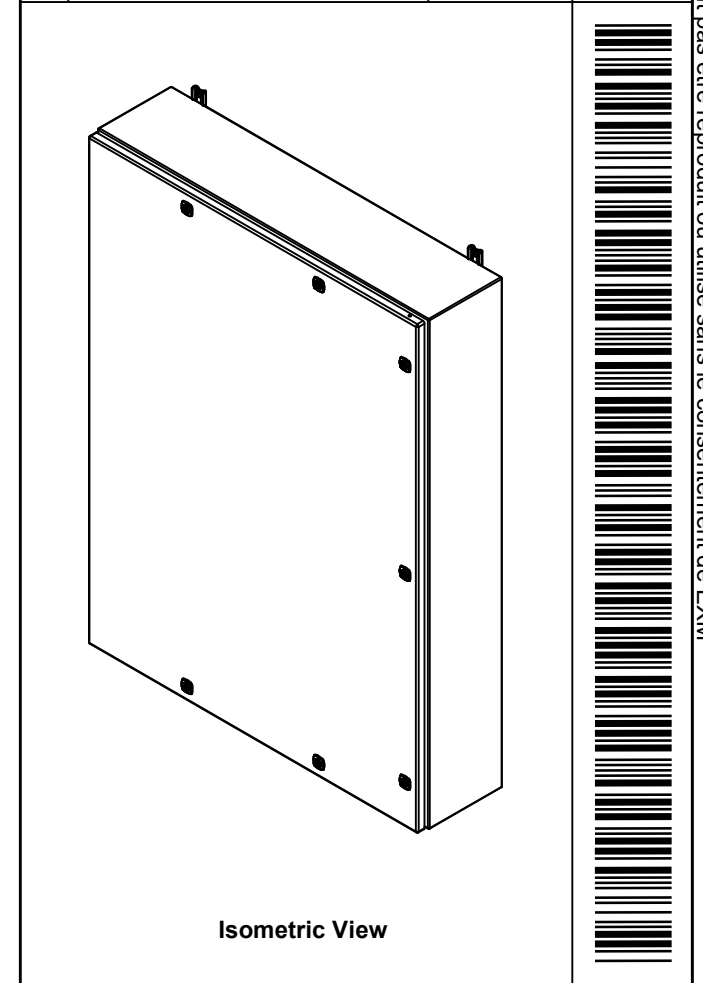

PACKING		
ITEM	QTY	DESCRIPTION
Cardboard sleeve	2	Top and Bottom
Cardboard strip	2	Between back of enclosure and inner panel
Plastic bag	1	To protect cover surface and inside gasket
Cardboard corner	4	To reinforced for the plastic strap tightening
Plastic strap - Black	2	To Squeeze the 2 cardboard sleeve together
Packaging label	3	White label with PN
Plastic strap- Green	2	To secure the enclosure to the wood pallet
Wood Pallet	1	2" deeper and 3" larger than enclosure size

8	STK-Q-00600	2	M12 to M8 Adaptor
1	881 SP4836G	0	881 SP - Inner Panel
1	STK-K-01800	5	5412 ES Accessory Kit
1	5412ESPR483608THC	0	5412ESPR 48" x 36" Cover
1	5412ESPR483608THB	0	5412ESPR 48" x 36" x 8" Body
8	STK-Q-04050-08	0	M6 x 8mm Hexagon Socket Head Machine Screw
Qty	Part Number	Rev	Description
Parts List			

	Tél: (450) 979-4373 Fax: (450) 979-4626 www.exmweb.com	Flatness Aplatissement Max 3.0mm
	Projection 	Customer Client Date
Drawn By Dessiné Par BoxCad: BoxCad	Date 10-Mar-25	Material Matière 14 Ga Cold Rolled A1008 CS Type B (1.7mm)
Color Couleur Asa-61 Grey	Finish Fini Smooth	Description 5412ESPR 48" x 36" x 8" Assembly
Part Number Numéro Pièce 5412ESPR483608TH	Rev. 0	Detail Rev. 2 16

This drawing is confidential and must not be reproduced or used without the consent of EXM

Ce dessin est confidentiel et ne doit pas être reproduit ou utilisé sans le consentement de EXM

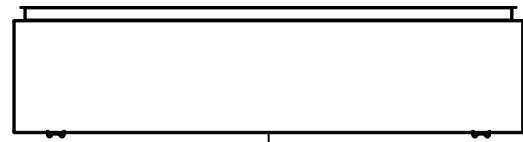

TOP

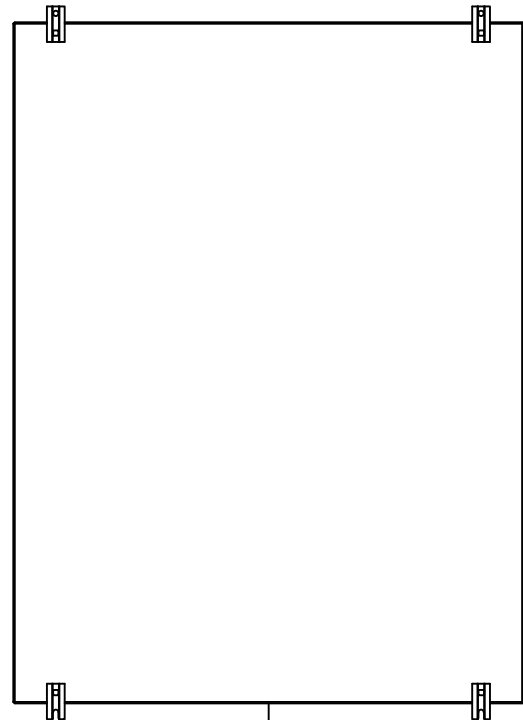

BACK

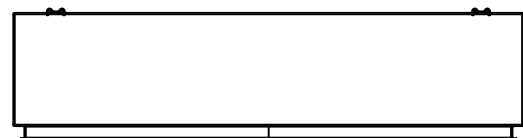

BOTTOM

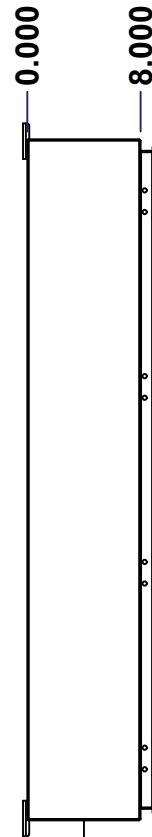

LEFT

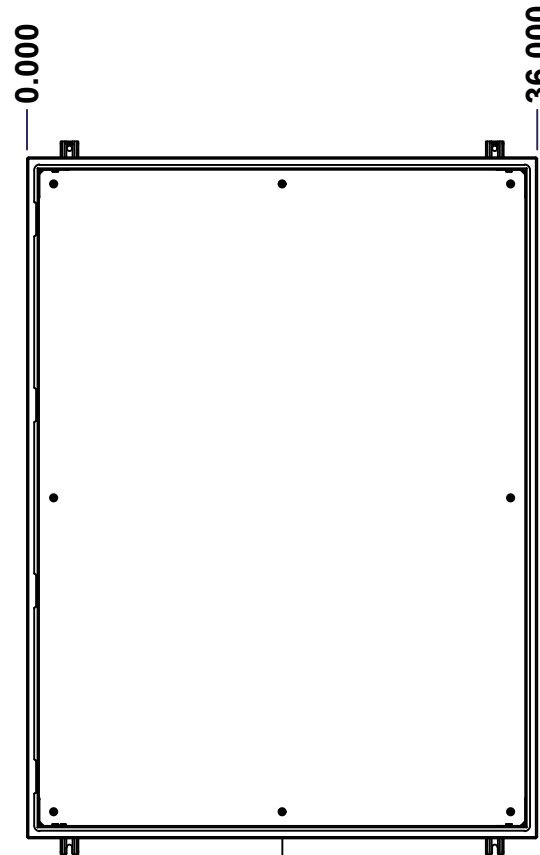

FRONT

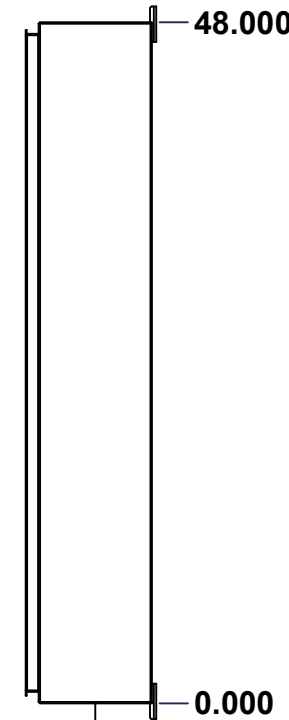

RIGHT

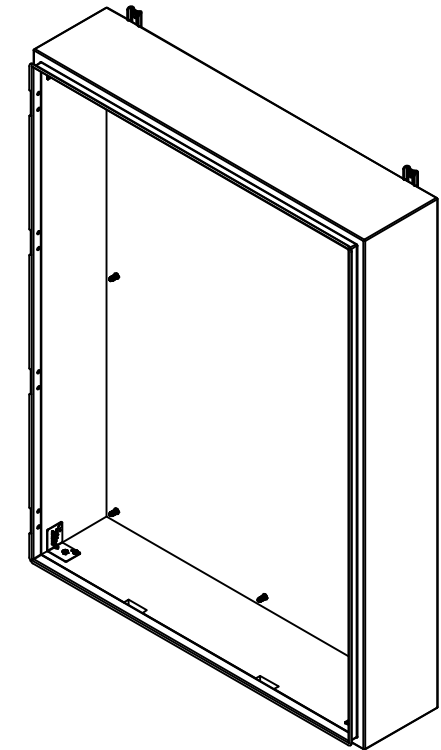

Isometric View

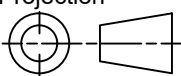

No.	Revisions	Date	By/Par

 Tél: (450) 979-4373 Fax: (450) 979-4626 www.exmweb.com		Flatness Aplatissement Max 3.0mm Projection 
Customer Client	Date	
Drawn By Dessiné Par	BoxCad: BoxCad	Date 10-Mar-25
Material Matière	14 Ga Cold Rolled A1008 CS Type B (1.7mm)	
Color Couleur	Asa-61 Grey	Finish Fini Smooth
Description	Detail Rev.	
5412ESPR 48" x 36" x 8" Body		
Part Number Numéro Pièce	Rev. 0	3 / 16

SEE BILL OF MATERIAL ON LAST PAGE

5412ESPR483608THB

This drawing is confidential and must not be reproduced or used without the consent of EXM

Ce dessin est confidentiel et ne doit pas être reproduit ou utilisé sans le consentement de EXM

STANDARD FEATURES ARE NOT LISTED IN THIS HOLE TABLE			
HOLE TABLE - TOP VIEW (CUSTOM FEATURE ONLY)			
CUT-OUT	XDIM	YDIM	DESCRIPTION
1	2.000	6.500	INSUL. STUD M6 x 18mm (Inside)
2	34.000	6.500	INSUL. STUD M6 x 18mm (Inside)

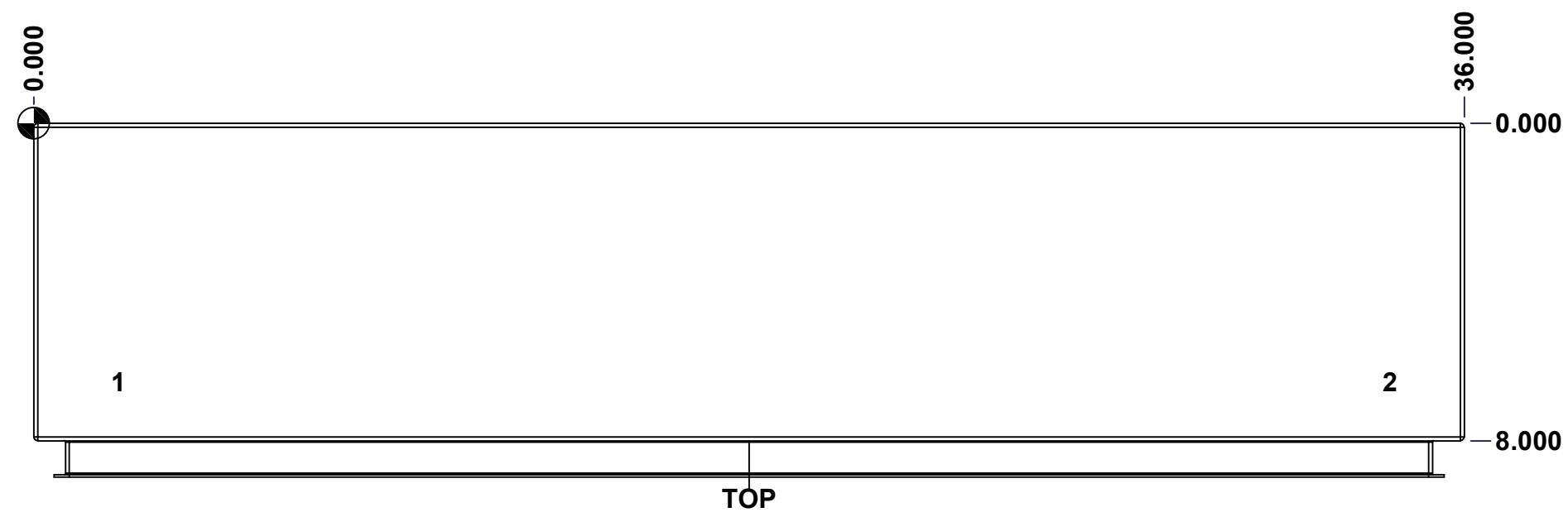

	Description	Status
	5412ESPR 48" x 36" x 8" Body	(NULL)
Part Number Numéro Pièce 5412ESPR483608THB	Rev.	4
	0	16

This drawing is confidential and must not be reproduced or used without the consent of EXM

Ce dessin est confidentiel et ne doit pas être reproduit ou utilisé sans le consentement de EXM

STANDARD FEATURES ARE NOT LISTED IN THIS HOLE TABLE			
HOLE TABLE - BOTTOM VIEW (CUSTOM FEATURE ONLY)			
CUT-OUT	XDIM	YDIM	DESCRIPTION
1	2.000	6.500	INSUL. STUD M6 x 18mm (Inside)
2	34.000	6.500	INSUL. STUD M6 x 18mm (Inside)

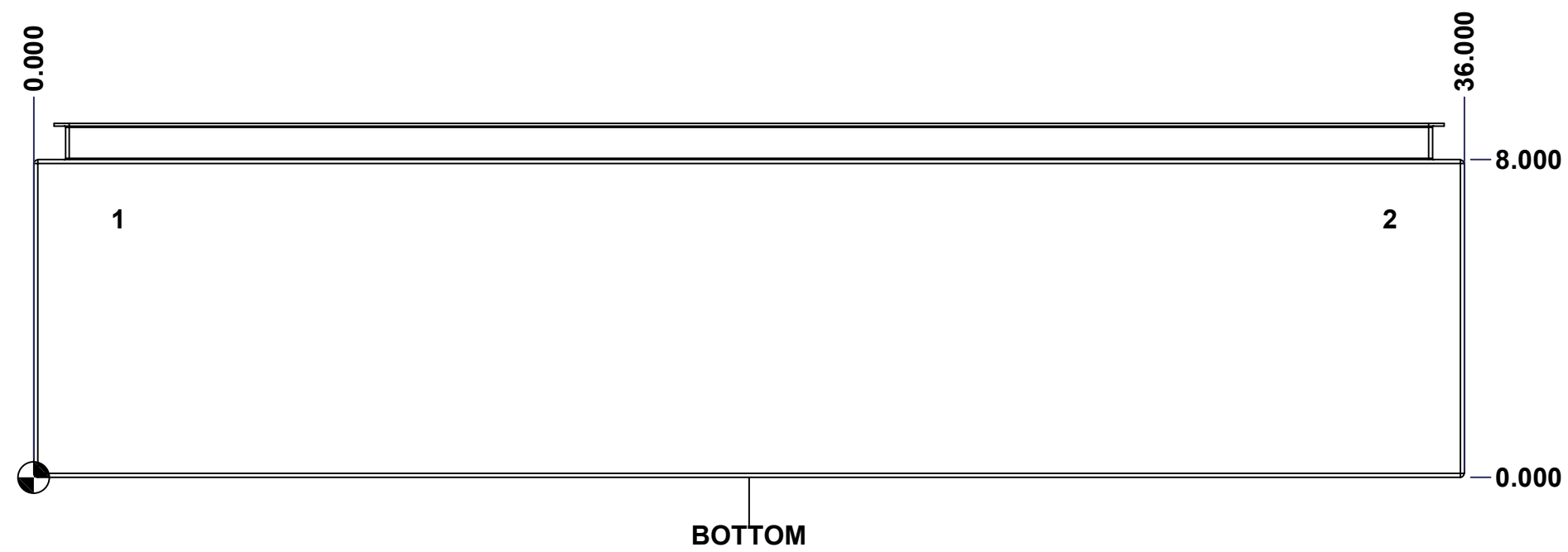

	Description	Status
	5412ESPR 48" x 36" x 8" Body	(NULL)
	Part Number Numéro Pièce	Rev.
	5412ESPR483608THB	0 / 5
		16

This drawing is confidential and must not be reproduced or used without the consent of EXM

Ce dessin est confidentiel et ne doit pas être reproduit ou utilisé sans le consentement de EXM

STANDARD FEATURES ARE NOT LISTED IN THIS HOLE TABLE

HOLE TABLE - BACK VIEW (CUSTOM FEATURE ONLY)

CUT-OUT	XDIM	YDIM	DESCRIPTION
1	1.875	1.875	IP STUD M8 x 35mm (Inside)
2	1.875	46.125	IP STUD M8 x 35mm (Inside)
3	34.125	46.125	IP STUD M8 x 35mm (Inside)
4	34.125	1.875	IP STUD M8 x 35mm (Inside)
5	1.875	24.000	IP STUD M8 x 35mm (Inside)
6	34.125	24.000	IP STUD M8 x 35mm (Inside)
7	18.000	1.875	IP STUD M8 x 35mm (Inside)
8	18.000	46.125	IP STUD M8 x 35mm (Inside)

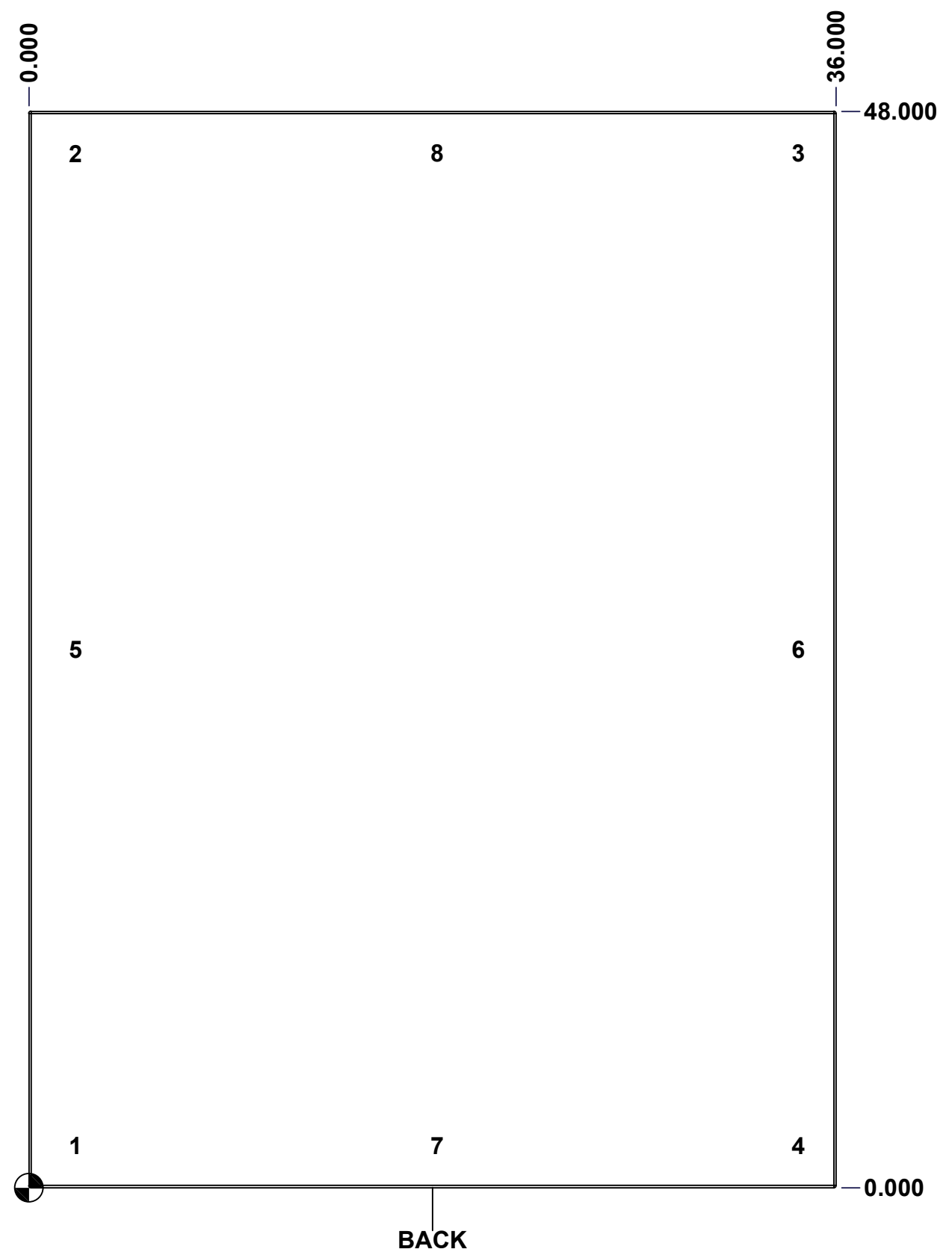



	Description	Status
	5412ESPR 48" x 36" x 8" Body	(NULL)
	Part Number Numéro Pièce	Rev.
	5412ESPR483608THB	0 / 6
		16

This drawing is confidential and must not be reproduced or used without the consent of EXM

Ce dessin est confidentiel et ne doit pas être reproduit ou utilisé sans le consentement de EXM

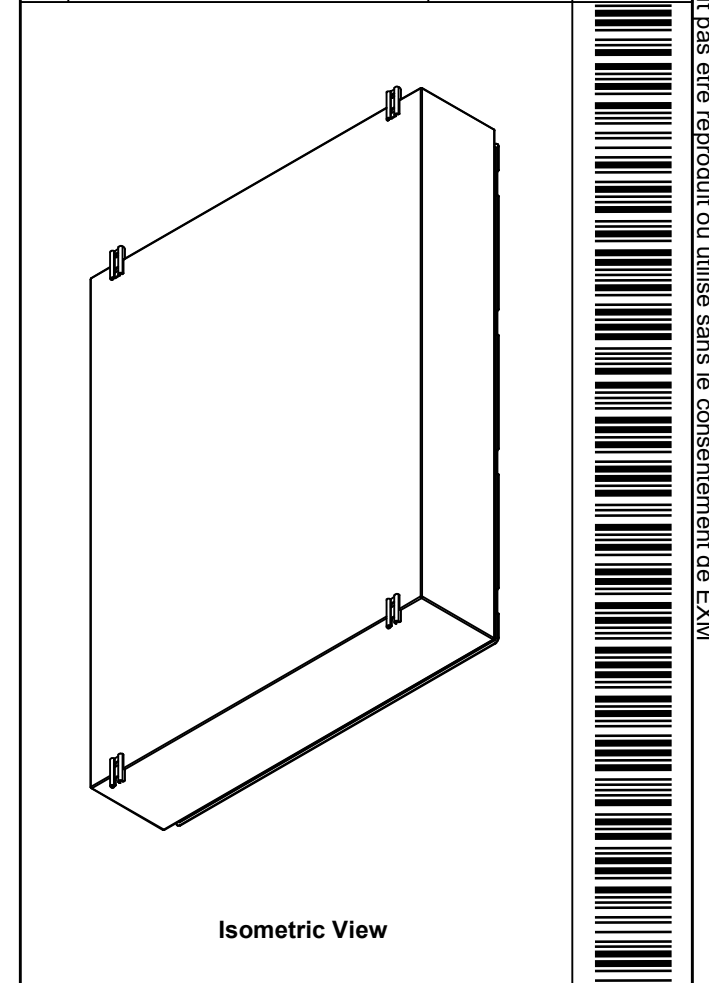
No.	Revisions	Date	By/Par

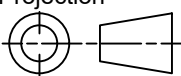

 Tél: (450) 979-4373 Fax: (450) 979-4626 www.exmweb.com		Flatness Aplatissement Max 3.0mm Projection 
Customer Client	Date	
Drawn By Dessiné Par	BoxCad: BoxCad	Date 10-Mar-25
Material Matière	14 Ga Cold Rolled A1008 CS Type B (1.7mm)	
Color Couleur	Asa-61 Grey	Finish Fini Smooth
Description		Detail Rev.
5412ESPR 48" x 36" x 8" Body		
Part Number Numéro Pièce	Rev.	7
5412ESPR483608THB	0	16

1	STK-K-70554	3	5412 ESTH Accessory Kit
1	5412ESPR483608THI-RS	0	5412ESPR 48" x 36" Right Insulation
1	5412ESPR483608THI-LS	0	5412ESPR 48" x 36" Left Insulation
1	5412ESPR483608THI-BT	0	5412ESPR 48" x 36"Bottom Insulation
1	5412ESPR483608THI-TP	0	5412ESPR 48" x 36"Top Insulation
1	5412ESPR483608THI-B	0	5412ESPR 48" x 36" Back Insulation
4	STK-Q-16055	1	M6 x 18mm Stud (No Paint Cap Required)
2	885ESMF3-FEET	0	885 ESMF3 Mounting Foot (Close)
2	885ESMF3-FEET-A	0	885 ESMF3 Mounting Foot (Open)
1	STK-P-02400S	0	Powder Paint (Asa-61 Grey / Smooth)
8	STK-Q-16005	0	Stud M8 x 35mm Steel
1	5412ESPR483608THB-P	0	5412ESPR 48" x 36" x 8" Body Part
Qty	Part Number	Rev	Description
Parts List			

This drawing is confidential and must not be reproduced or used without the consent of EXM

Ce dessin est confidentiel et ne doit pas être reproduit ou utilisé sans le consentement de EXM

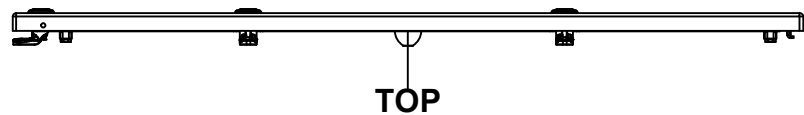

TOP

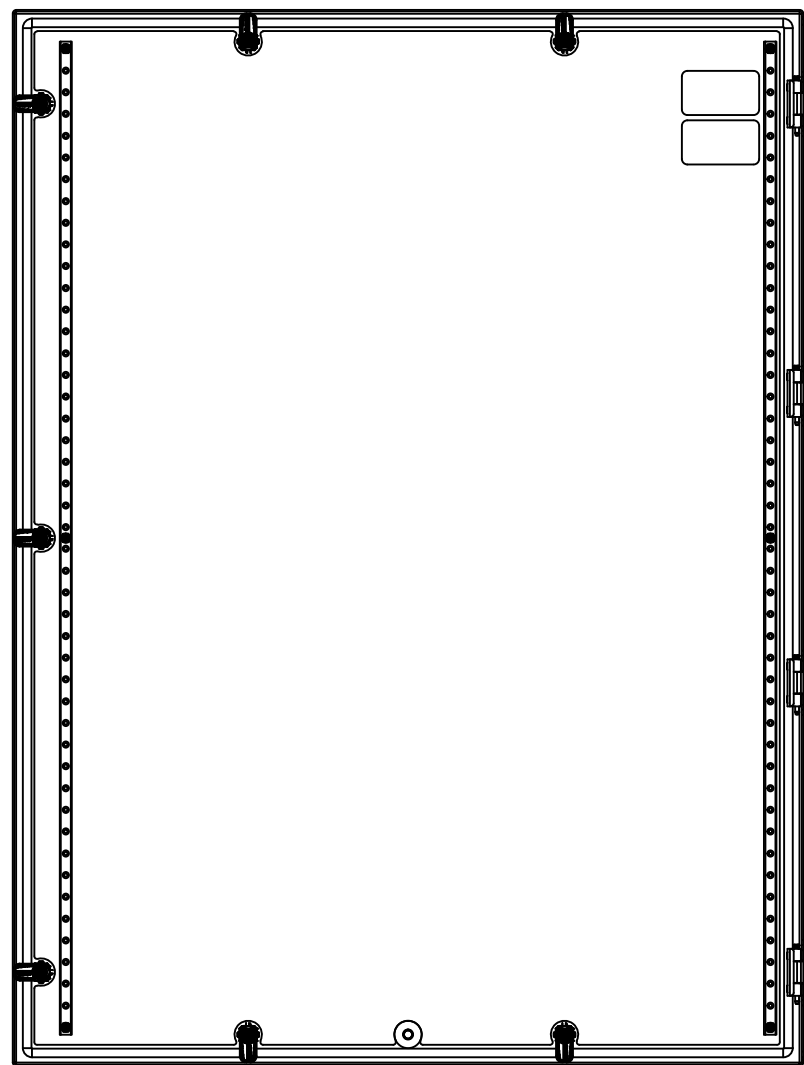

BACK



BOTTOM

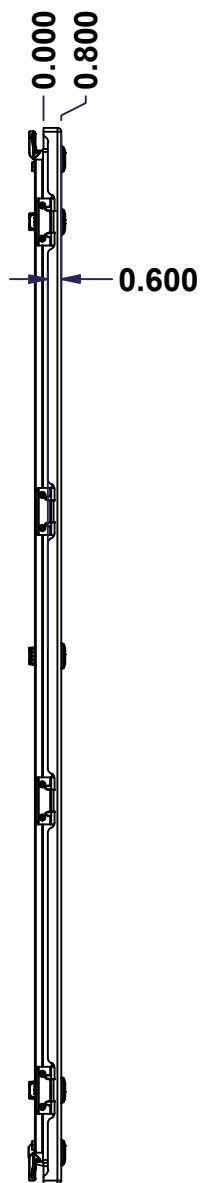

LEFT

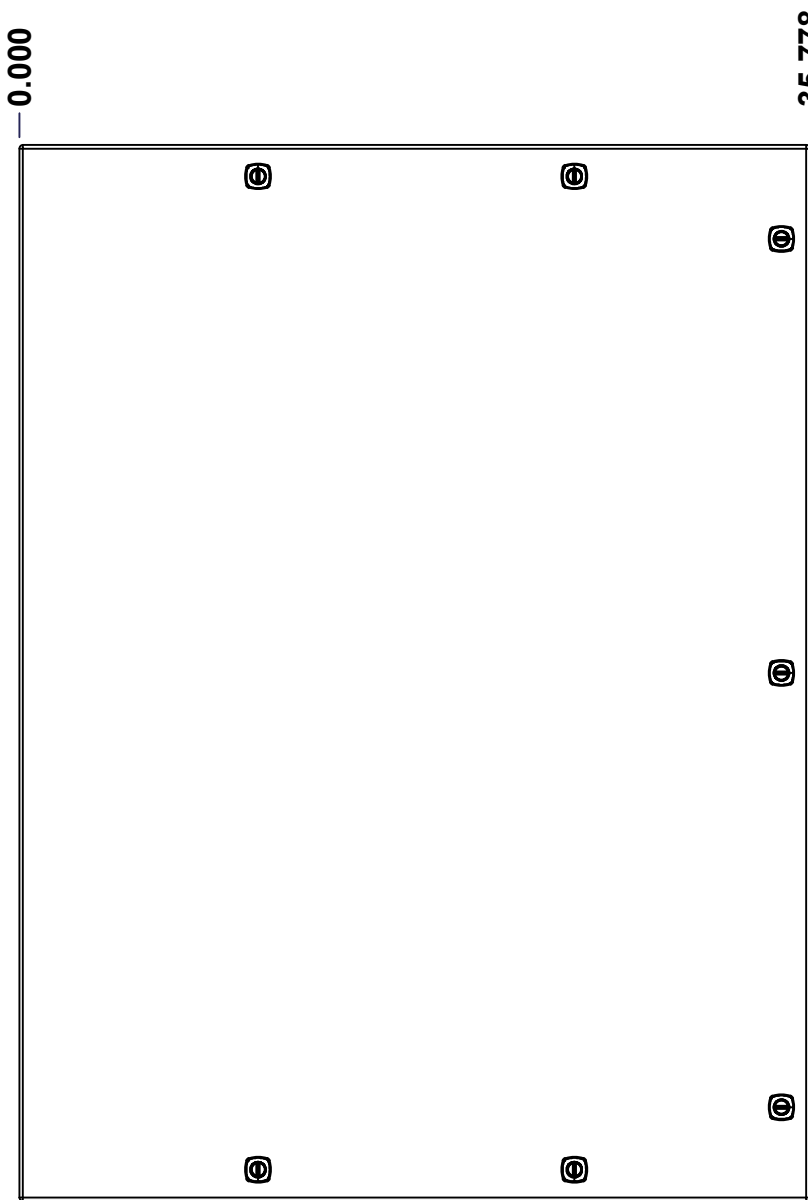

FRONT

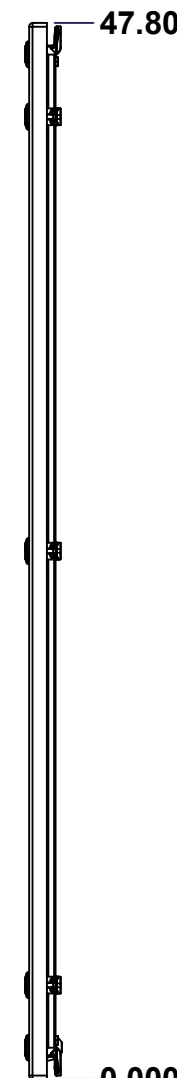

RIGHT

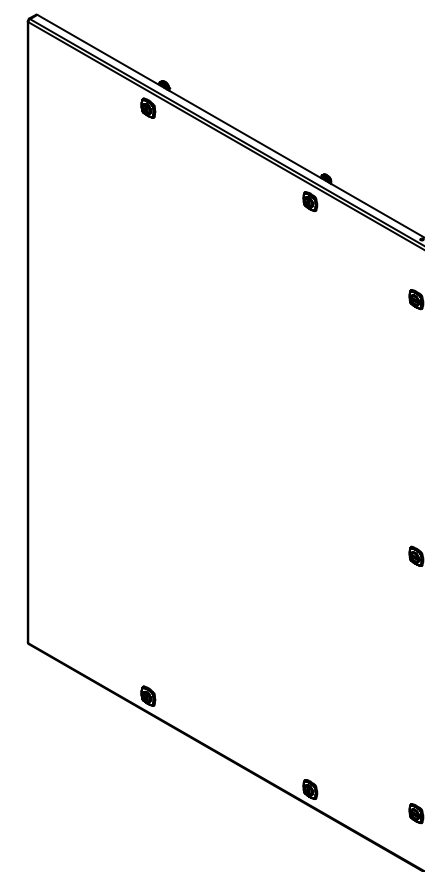

Isometric View

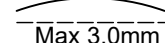
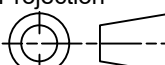

No.	Revisions	Date	By/Par

 Tél: (450) 979-4373 Fax: (450) 979-4626 www.exmweb.com		Flatness Aplatissement  Max 3.0mm Projection 
Customer Client	Date	
Drawn By Dessiné Par	BoxCad: BoxCad	Date 10-Mar-25
Material Matière	14 Ga Cold Rolled A1008 CS Type B (1.7mm)	
Color Couleur	Asa-61 Grey	Finish Fini Smooth
Description 5412ESPR 48" x 36" Cover		Detail Rev.
Part Number Numéro Pièce	Rev. 0	8 / 16

SEE BILL OF MATERIAL ON LAST PAGE

5412ESPR483608THC

This drawing is confidential and must not be reproduced or used without the consent of EXM

Ce dessin est confidentiel et ne doit pas être reproduit ou utilisé sans le consentement de EXM

STANDARD FEATURES ARE NOT LISTED IN THIS HOLE TABLE

HOLE TABLE - FRONT VIEW (CUSTOM FEATURE ONLY)

CUT-OUT	XDIM	YDIM	DESCRIPTION
1	1.486	1.756	STUD M6 x 18mm (Inside)
2	1.486	46.047	STUD M6 x 18mm (Inside)
3	33.377	46.047	STUD M6 x 18mm (Inside)
4	33.377	1.756	STUD M6 x 18mm (Inside)
5	1.486	23.902	STUD M6 x 18mm (Inside)
6	33.377	23.902	STUD M6 x 18mm (Inside)
7	17.959	1.435	STUD M6 x 18mm (Inside)

8	34.494	43.553	LOCK 880 SCQ4-SL @ 0.0°
9	34.494	23.902	LOCK 880 SCQ4-SL @ 0.0°
10	34.494	4.250	LOCK 880 SCQ4-SL @ 0.0°
11	10.800	46.379	LOCK 880 SCQ4-SL @ 90.0°
12	25.118	46.379	LOCK 880 SCQ4-SL @ 90.0°
13	10.800	1.424	LOCK 880 SCQ4-SL @ 270.0°
14	25.118	1.424	LOCK 880 SCQ4-SL @ 270.0°

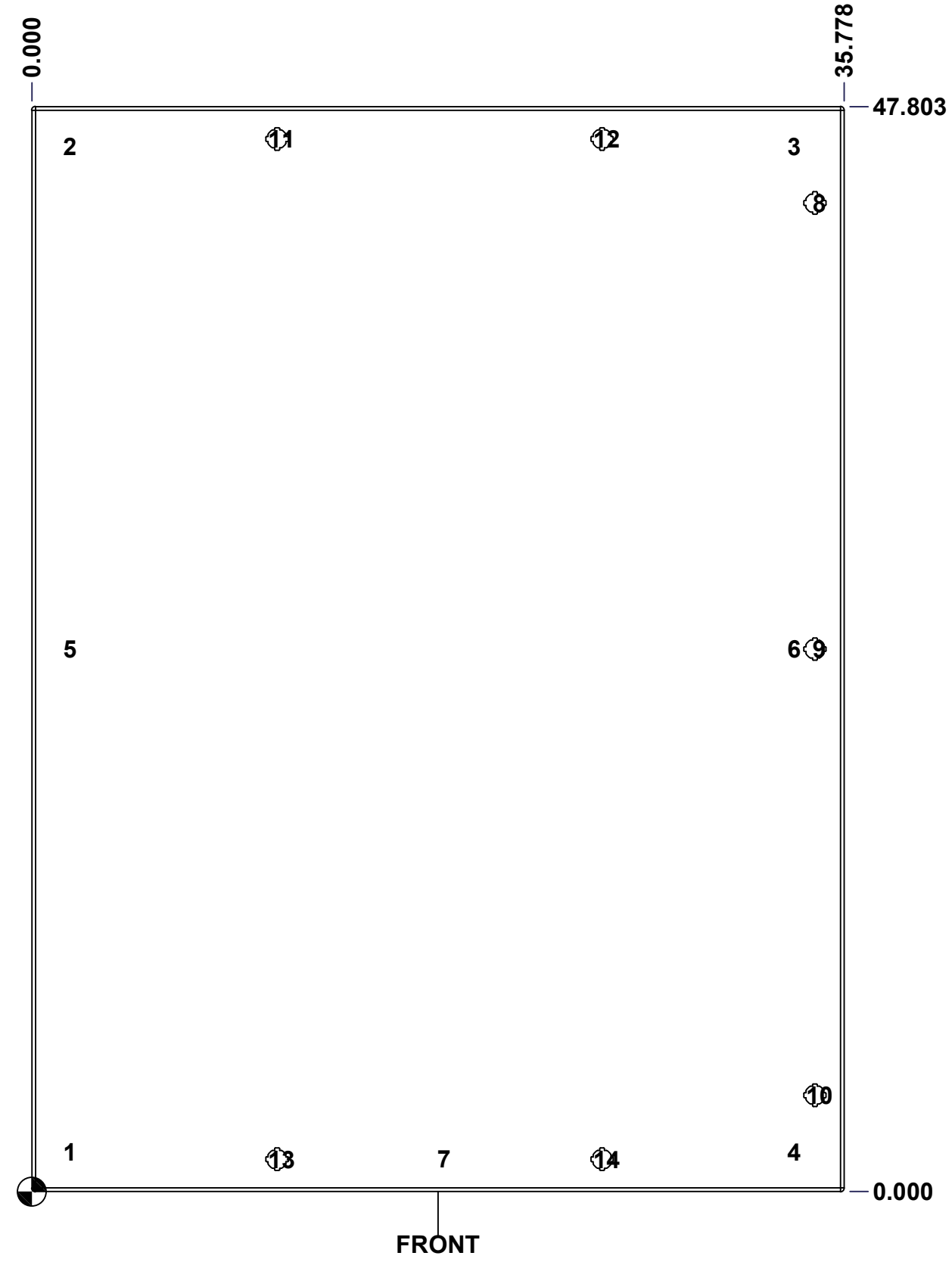

	Description	Status
	5412ESPR 48" x 36" Cover	(NULL)
	Part Number Numéro Pièce	Rev.
	5412ESPR483608THC	0
		9
		16

This drawing is confidential and must not be reproduced or used without the consent of EXM

Ce dessin est confidentiel et ne doit pas être reproduit ou utilisé sans le consentement de EXM

No.	Revisions	Date	By/Par

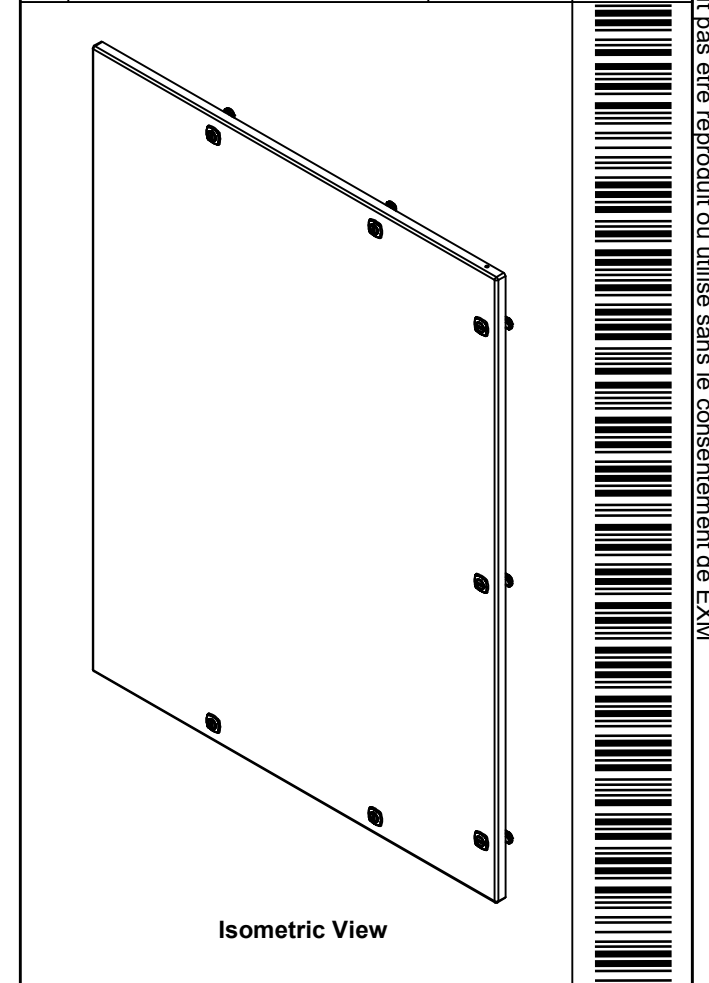

EXM
www.exm.com

Tél: (450) 979-4373
Fax: (450) 979-4626
www.exmweb.com

Flatness
Aplatissement
Max 3.0mm

Projection

7	STK-K-12500	19	5412 ES 1/4 Turn Lock
2	STK-S-00100	0	3.5" x 2" Silver Milar Flexcon Sticker
6	STK-Q-07250	2	M6 x 16mm Collar Nut
2	STK-Q-46020-48	5	5412 ES Vertical Door Stiffener 48"
1	5412ESPR483608THI-C	0	5412ESPR 48" x 36" Cover Insulation
1	STK-Q-46515	3	5412 ES Door Support with Brass Insert
7	STK-Q-16055	1	M6 x 18mm Stud (No Paint Cap Required)
1	5412ESPR483608THG	0	5412ESPR 48" x 36" Cover Gasket Part
1	5412ESPR483608THC-P	0	5412ESPR 48" x 36" Cover Part
4	STK-A-33005PR	1	5412 ESPR Hinge 180° (Body Part)

Customer Client	Date
Drawn By Dessiné Par BoxCad: BoxCad	Date 10-Mar-25
Material Matière 14 Ga Cold Rolled A1008 CS Type B (1.7mm)	
Color Couleur Asa-61 Grey	Finish Fini Smooth
Description 5412ESPR 48" x 36" Cover	Detail Rev.
Part Number Numéro Pièce 5412ESPR483608THC	Rev. 10 0 16

QTY	Part Number	Rev	Description
Parts List			

This drawing is confidential and must not be reproduced or used without the consent of EXM

Ce dessin est confidentiel et ne doit pas être reproduit ou utilisé sans le consentement de EXM

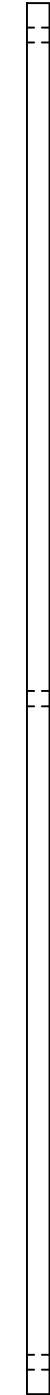
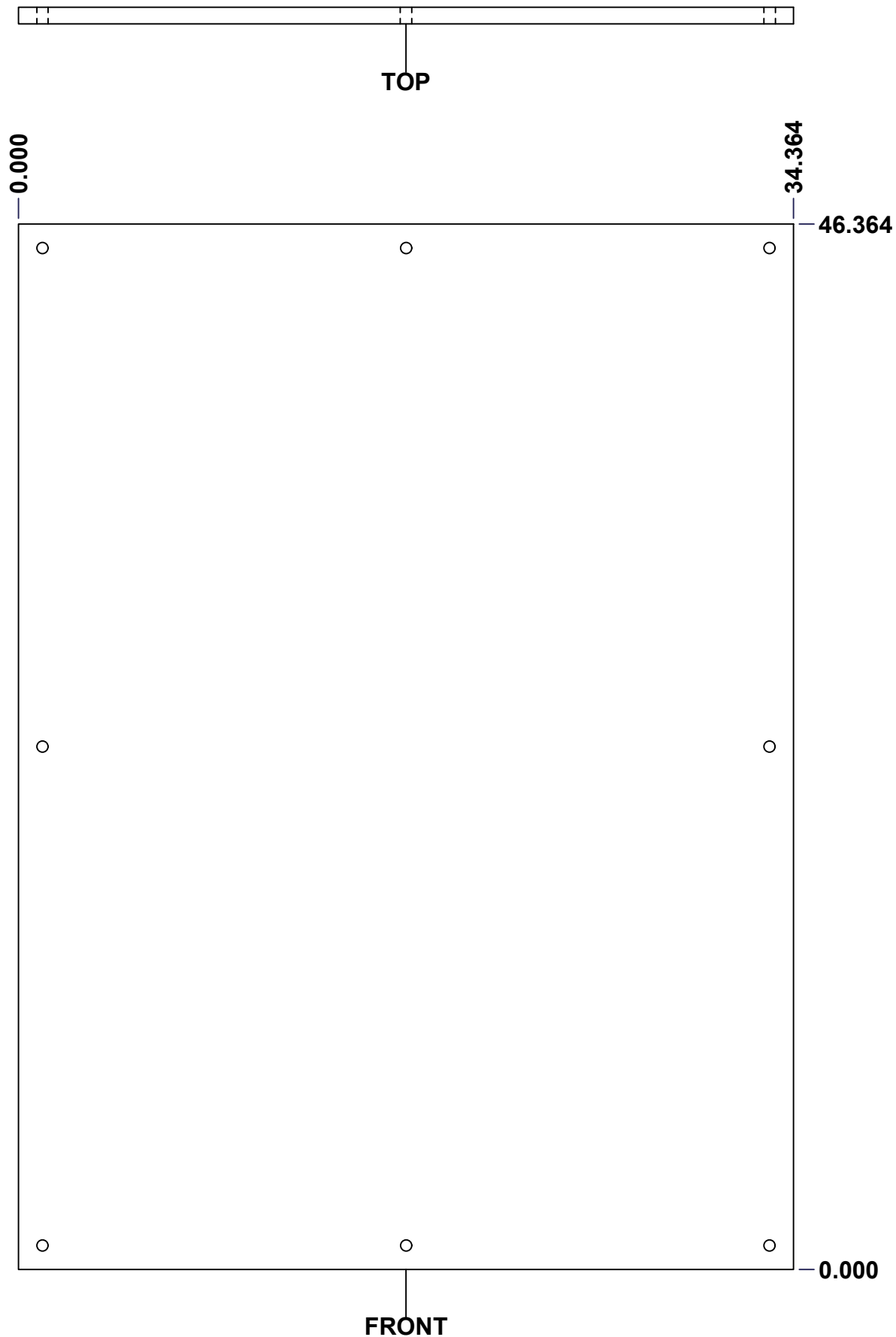

No.	Revisions	Date	By/Par

Isometric View

Tél: (450) 979-4373 Fax: (450) 979-4626 www.exmweb.com		Flatness Aplatissement	
		Max 3.0mm	
Customer Client		Date	
Drawn By Dessiné Par		Date	
Material Matière		Polyisocyanurate	
Color Couleur		Aluminum	Finish Fini
Description		Detail Rev.	
Part Number Numéro Pièce		Rev.	11
5412ESPR483608THI-B		0	16

SEE BILL OF MATERIAL ON LAST PAGE

This drawing is confidential and must not be reproduced or used without the consent of EXM

Ce dessin est confidentiel et ne doit pas être reproduit ou utilisé sans le consentement de EXM

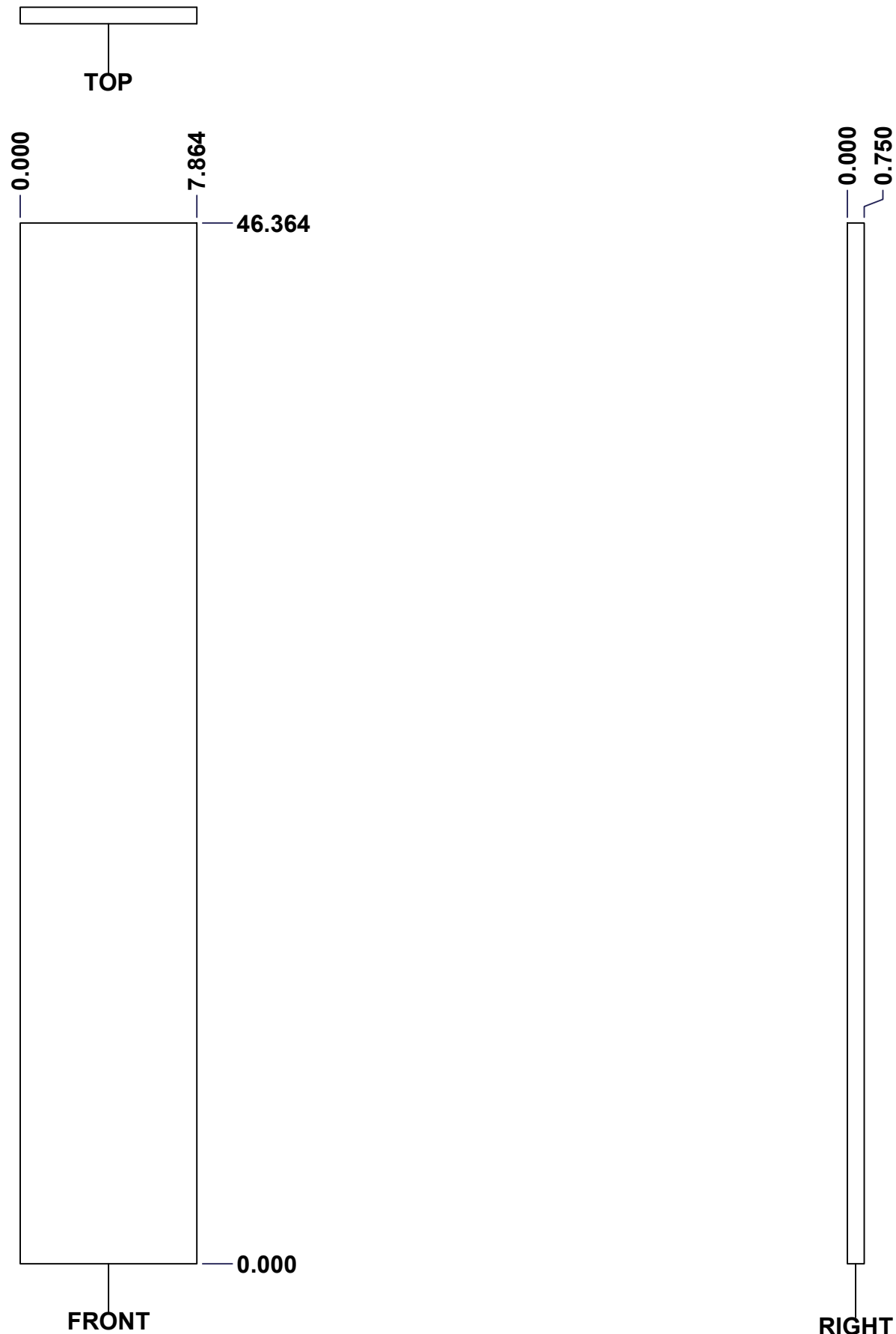

No.	Revisions	Date	By/Par

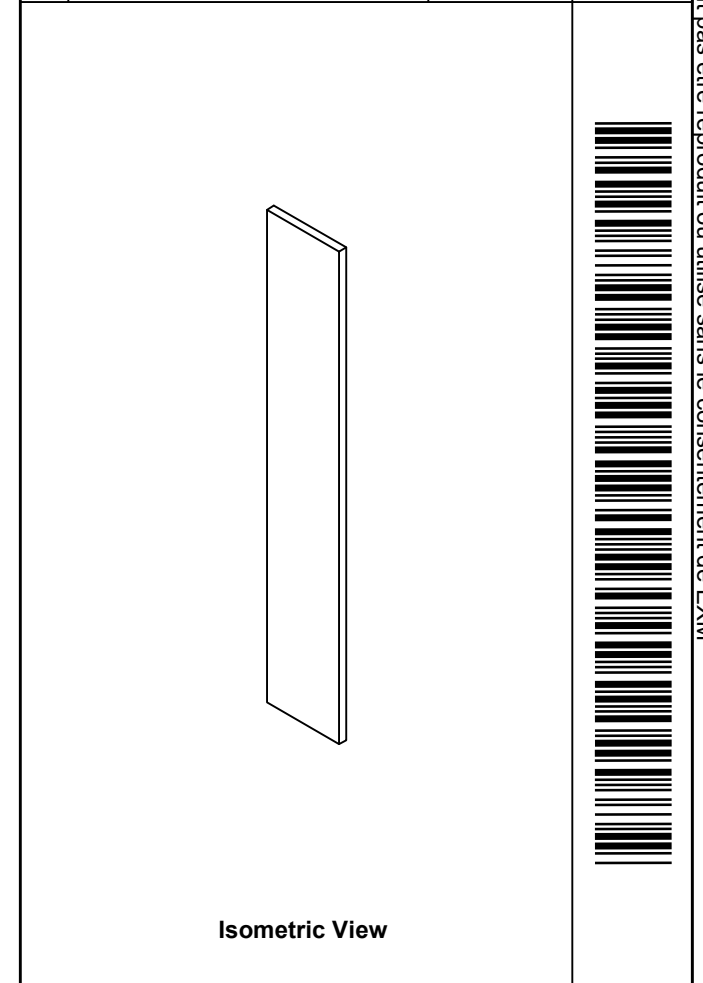

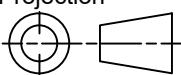
 Tél: (450) 979-4373 Fax: (450) 979-4626 www.exmweb.com		Flatness Aplatissement Max 3.0mm
Customer Client		Projection 
Drawn By / Dessiné Par: BoxCad: Patrick Deschenes		Date: 23-Jan-07
Material / Matière: Polyisocyanurate		
Color / Couleur: Aluminum	Finish / Fini: N/A	
Description: 5412ESPR 48" x 36" Left Insulation		Detail Rev.
Part Number / Numéro Pièce: 5412ESPR483608TH-LS		Rev. 0

SEE BILL OF MATERIAL ON LAST PAGE

This drawing is confidential and must not be reproduced or used without the consent of EXM

Ce dessin est confidentiel et ne doit pas être reproduit ou utilisé sans le consentement de EXM

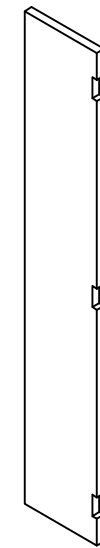
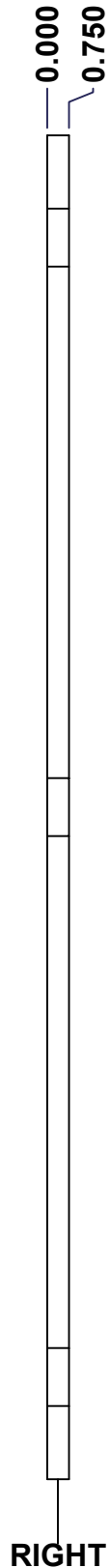
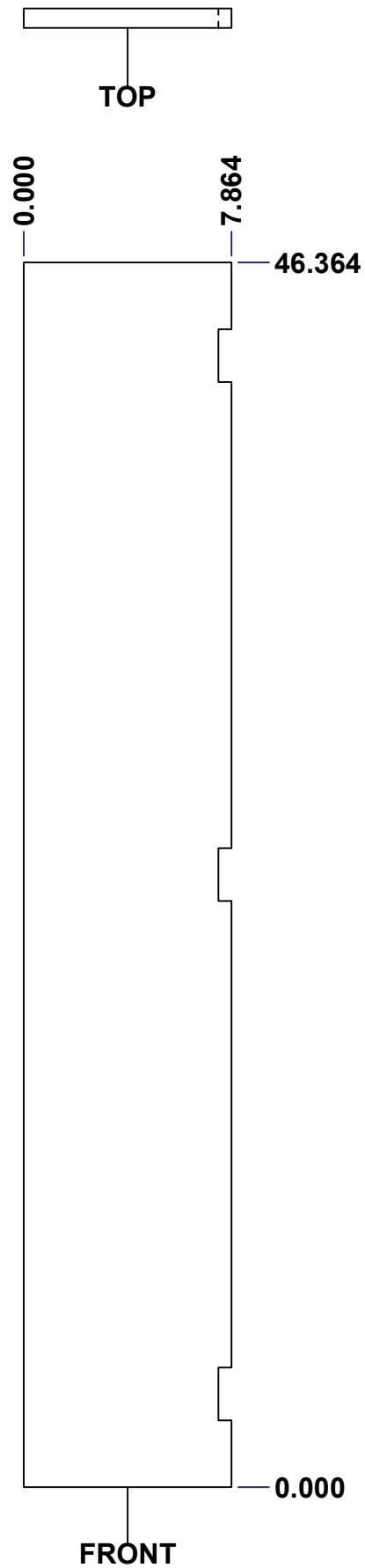

Isometric View



Tél: (450) 979-4373
 Fax: (450) 979-4626
www.exmweb.com

Flatness
Aplatissement

Max 3.0mm

Projection

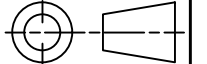

Customer Client	Date
Drawn By Dessiné Par	Date
Material Matière	23-Jan-07
Polyisocyanurate	
Color Couleur	Finish Fini
Aluminum	N/A

Description	Detail Rev.
5412ESPR 48" x 36" Right Insulation	

Part Number Numéro Pièce	Rev.	13
5412ESPR483608THI-RS	0	16

SEE BILL OF MATERIAL ON LAST PAGE

This drawing is confidential and must not be reproduced or used without the consent of EXM

Ce dessin est confidentiel et ne doit pas être reproduit ou utilisé sans le consentement de EXM

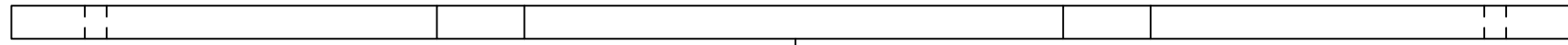

TOP

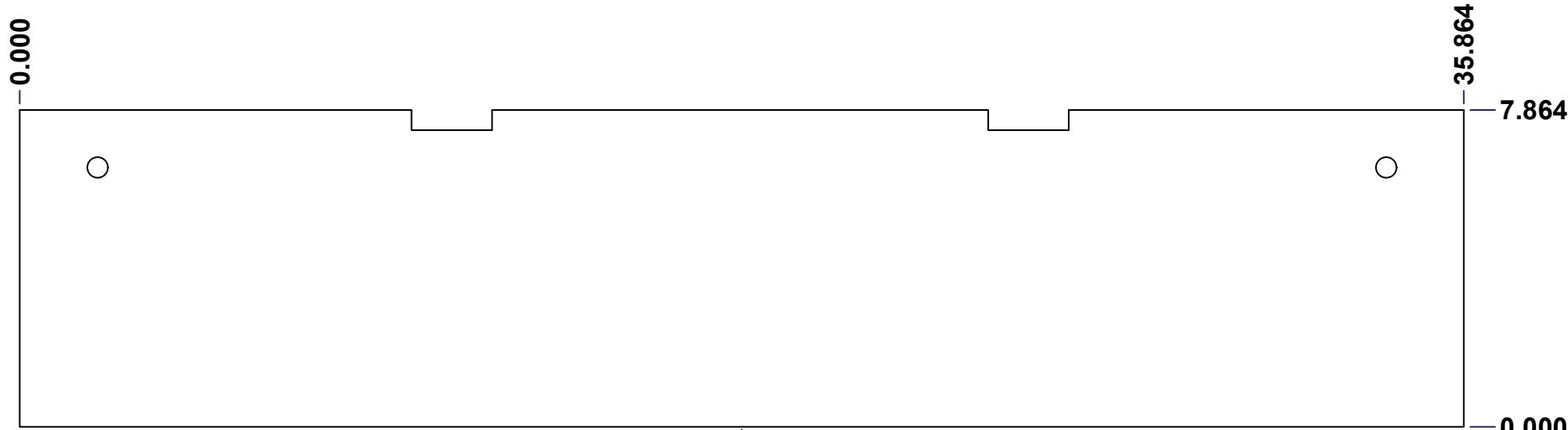

FRONT

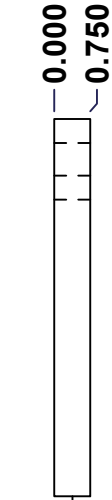

RIGHT

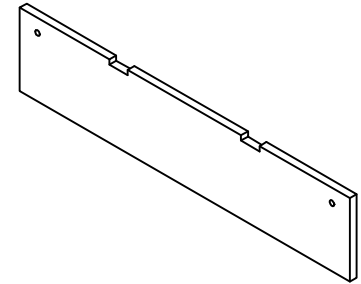

Isometric View



Tél: (450) 979-4373
 Fax: (450) 979-4626
www.exmweb.com

Flatness
Aplatissement

Max 3.0mm

Projection

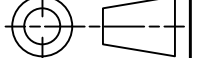

Customer Client	Date
Drawn By Dessiné Par BoxCad: BoxCad	Date 4/3/2024
Material Matière Polyisocyanurate	
Color Couleur Aluminum	Finish Fini Smooth
Description 5412ESPR 48" x 36"Top Insulation	Detail Rev.
Part Number Numéro Pièce 5412ESPR483608TH-TP	Rev. 0
	14 16

SEE BILL OF MATERIAL ON LAST PAGE

This drawing is confidential and must not be reproduced or used without the consent of EXM

Ce dessin est confidentiel et ne doit pas être reproduit ou utilisé sans le consentement de EXM

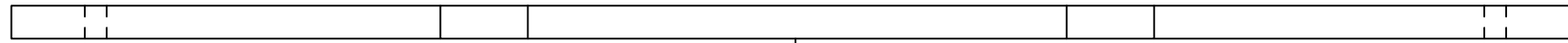

TOP

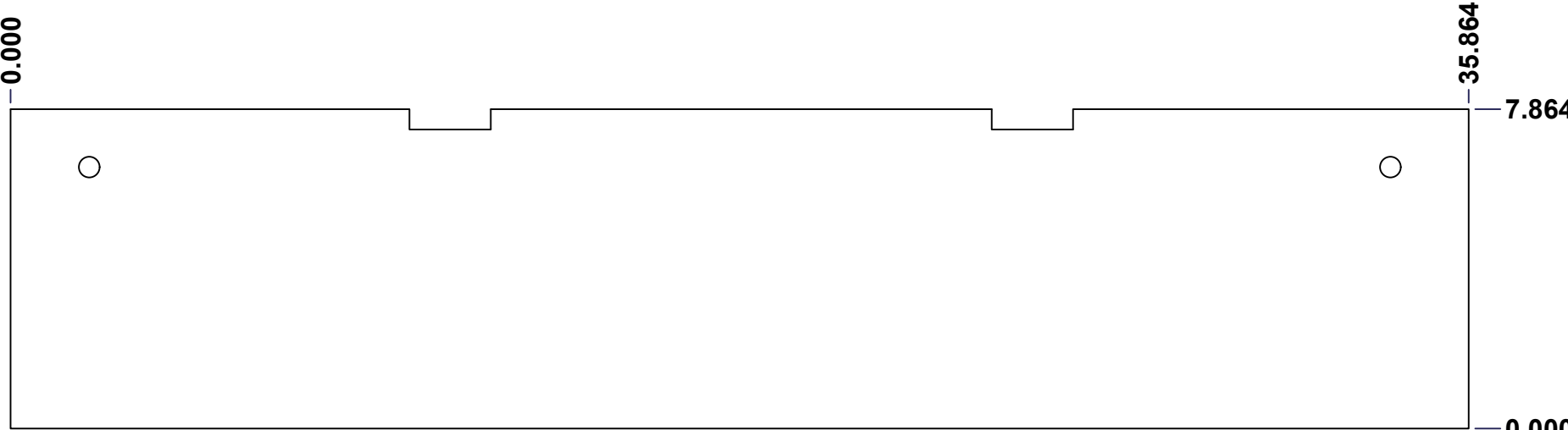

FRONT

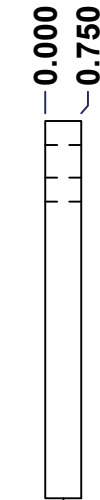

RIGHT

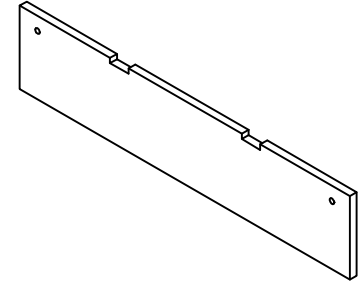

Isometric View

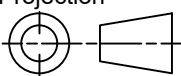

No.	Revisions	Date	By/Par

 Tél: (450) 979-4373 Fax: (450) 979-4626 www.exmweb.com		Flatness Aplatissement Max 3.0mm Projection 
Customer Client	Date	
Drawn By Dessiné Par	BoxCad: BoxCad	Date 4/3/2024
Material Matière	Polyisocyanurate	
Color Couleur	Aluminum	Finish Fini Smooth
Description 5412ESPR 48" x 36"Bottom Insulation		Detail Rev.
Part Number Numéro Pièce	Rev. 0	15 / 16

SEE BILL OF MATERIAL ON LAST PAGE

5412ESPR483608THI-BT

This drawing is confidential and must not be reproduced or used without the consent of EXM

Ce dessin est confidentiel et ne doit pas être reproduit ou utilisé sans le consentement de EXM

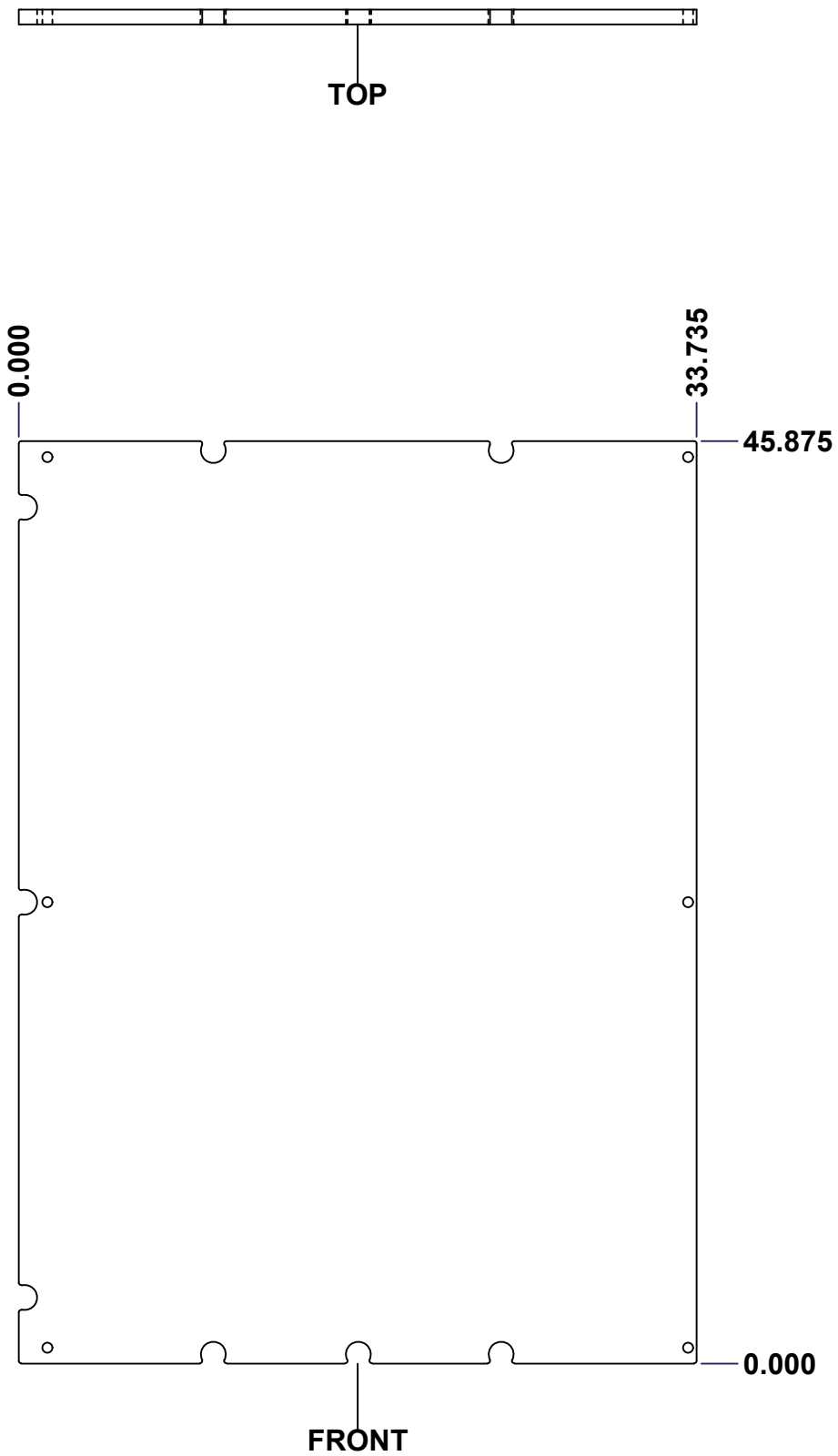

No.	Revisions	Date	By/Par

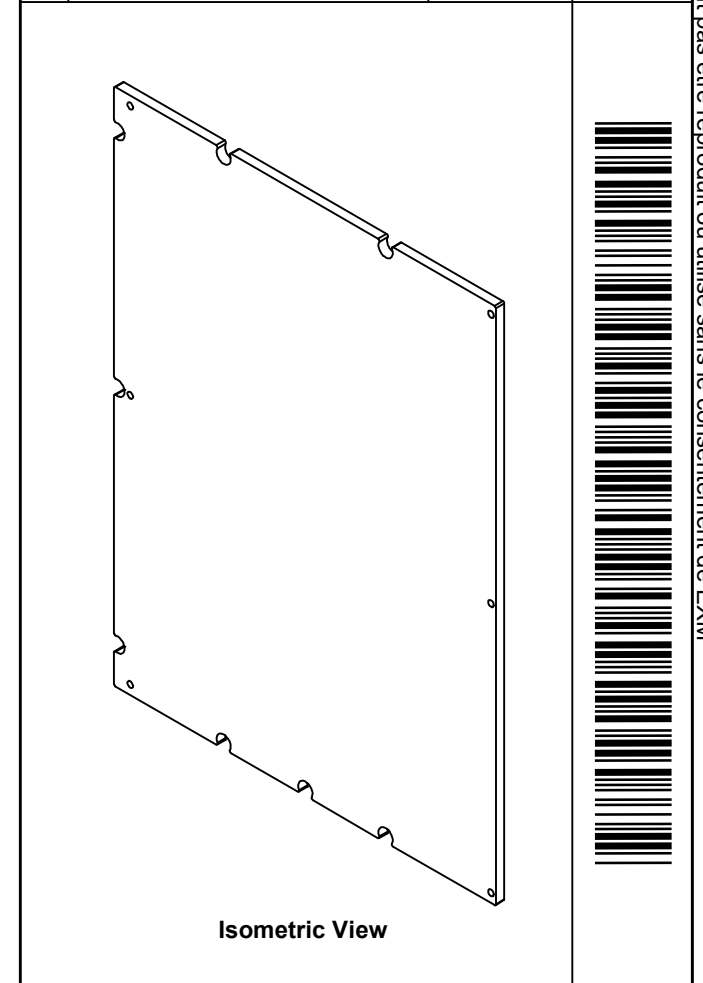

 Tél: (450) 979-4373 Fax: (450) 979-4626 www.exmweb.com		Flatness Aplatissement Max 3.0mm
Customer Client		Date
Drawn By Dessiné Par BoxCad: Patrick Deschenes		Date 23-Jan-07
Material Matière Polyisocyanurate		
Color Couleur Aluminum	Finish Fini N/A	
Description 5412ESPR 48" x 36" Cover Insulation		Detail Rev.
Part Number Numéro Pièce 5412ESPR483608THI-C		Rev. 16 0

SEE BILL OF MATERIAL ON LAST PAGE

This drawing is confidential and must not be reproduced or used without the consent of EXM

Ce dessin est confidentiel et ne doit pas être reproduit ou utilisé sans le consentement de EXM

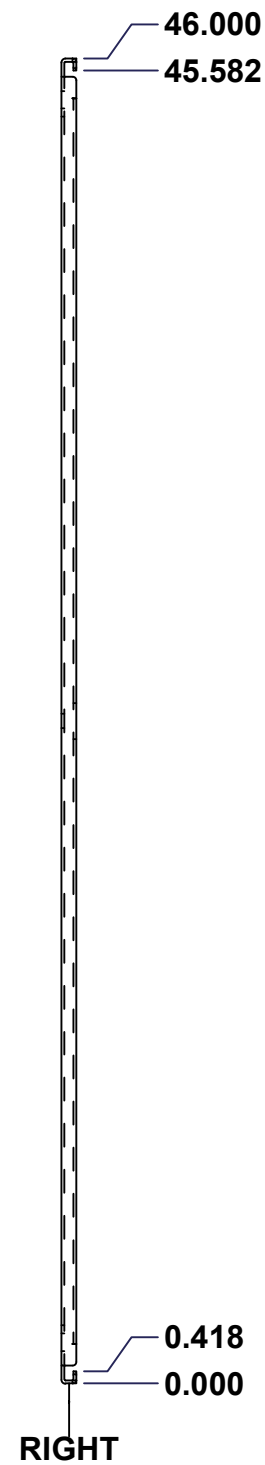
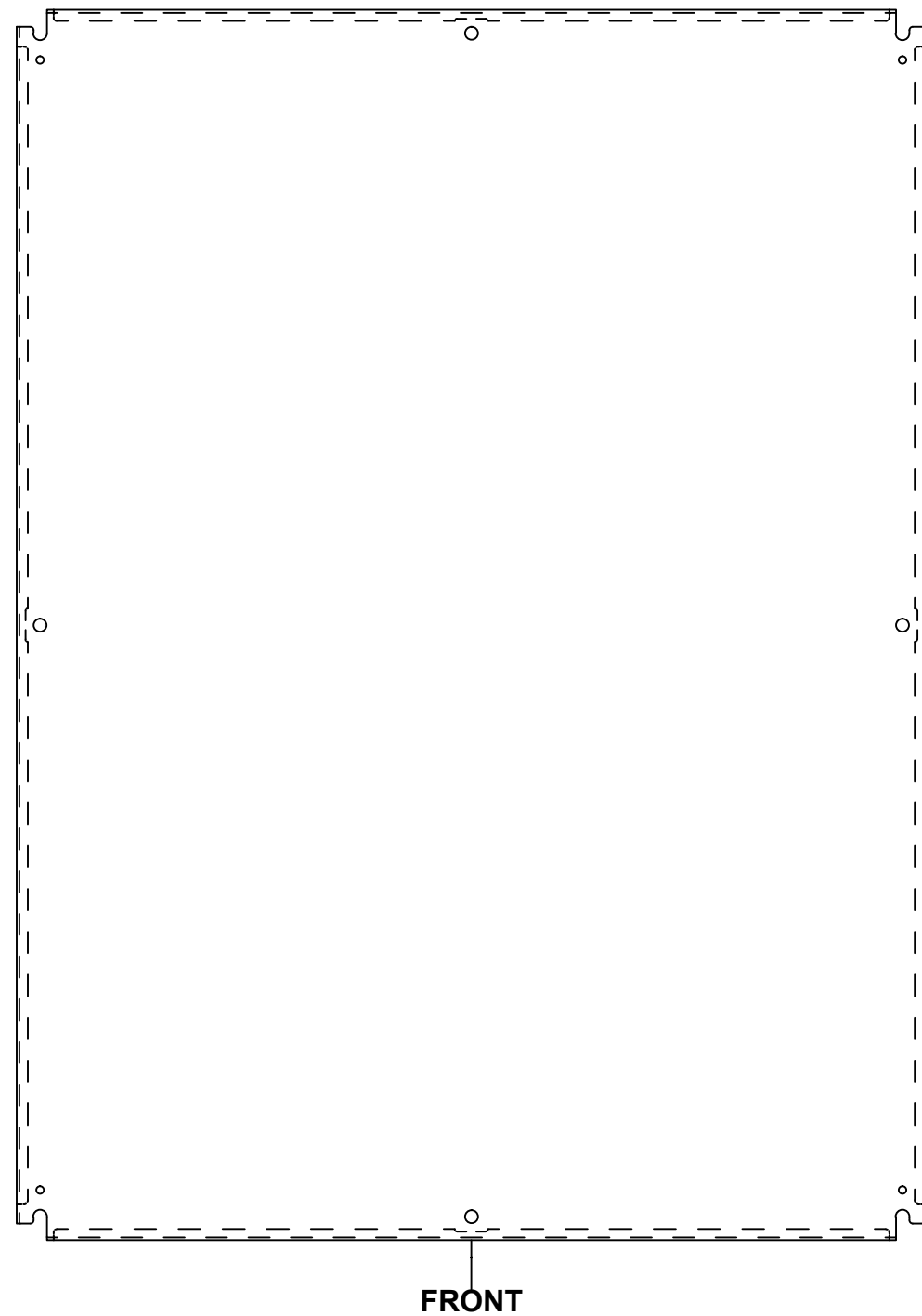
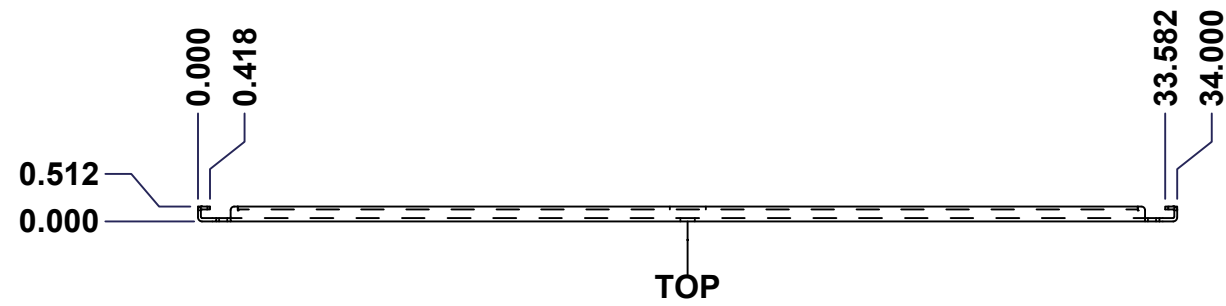

No.	Revisions	Date	By/Par

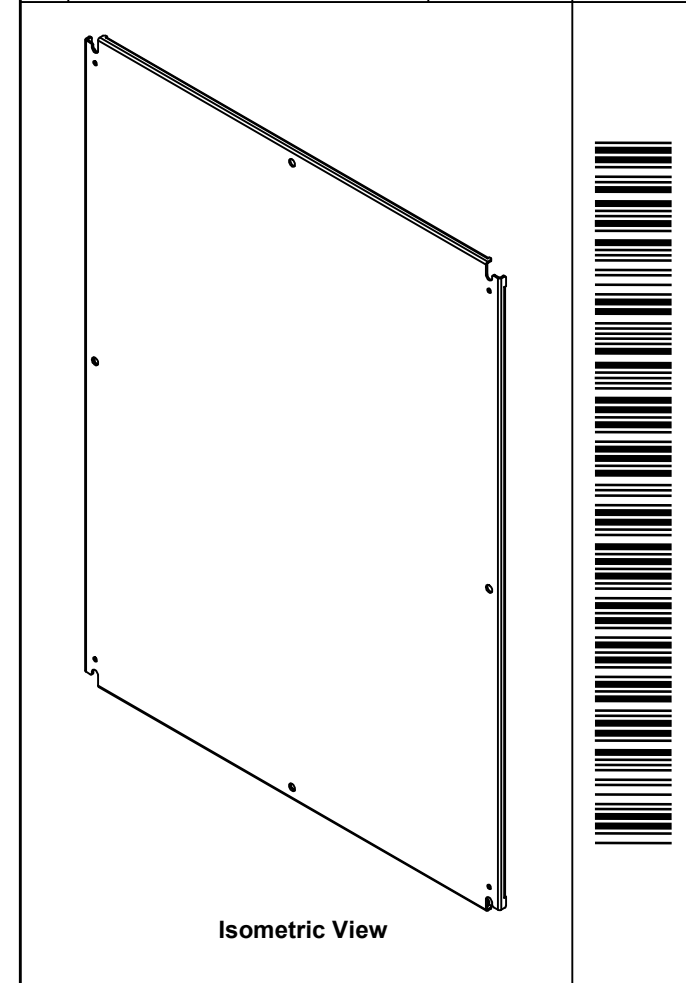

Tél: (450) 979-4373 Fax: (450) 979-4626 www.exmweb.com		Flatness Aplatissement Max 3.0mm Projection
Customer Client	Date	
Drawn By Dessiné Par	BoxCad	Date 23-Jan-07
Material Matière	See Part List	
Color Couleur	See Part List	Finish Fini See Part List
Description		Detail Rev.
881 SP - Inner Panel		
Part Number Numéro Pièce	881 SP4836G	Rev. 1 0 2

Qty	Part Number	Rev	Description	Material	Color	Finish
1	881 SP4836G-P	0	881 SP - Inner Panel Part	12 Ga Galvanized	Unpainted	Galvanized

Parts List

This drawing is confidential and must not be reproduced or used without the consent of EXM

Ce dessin est confidentiel et ne doit pas être reproduit ou utilisé sans le consentement de EXM

Table 1			FRONT VIEW
CUT-OUT	XDIM	YDIM	DESCRIPTION
1	17.000	0.875	MTG STUD HOLE (RND Ø0.500)
2	0.875	23.000	MTG STUD HOLE (RND Ø0.500)
3	33.125	23.000	MTG STUD HOLE (RND Ø0.500)
4	17.000	45.125	MTG STUD HOLE (RND Ø0.500)
5	0.875	1.875	GROUND HOLE (RND Ø0.290)
6	33.125	1.875	GROUND HOLE (RND Ø0.290)
7	0.875	44.125	GROUND HOLE (RND Ø0.290)
8	33.125	44.125	GROUND HOLE (RND Ø0.290)

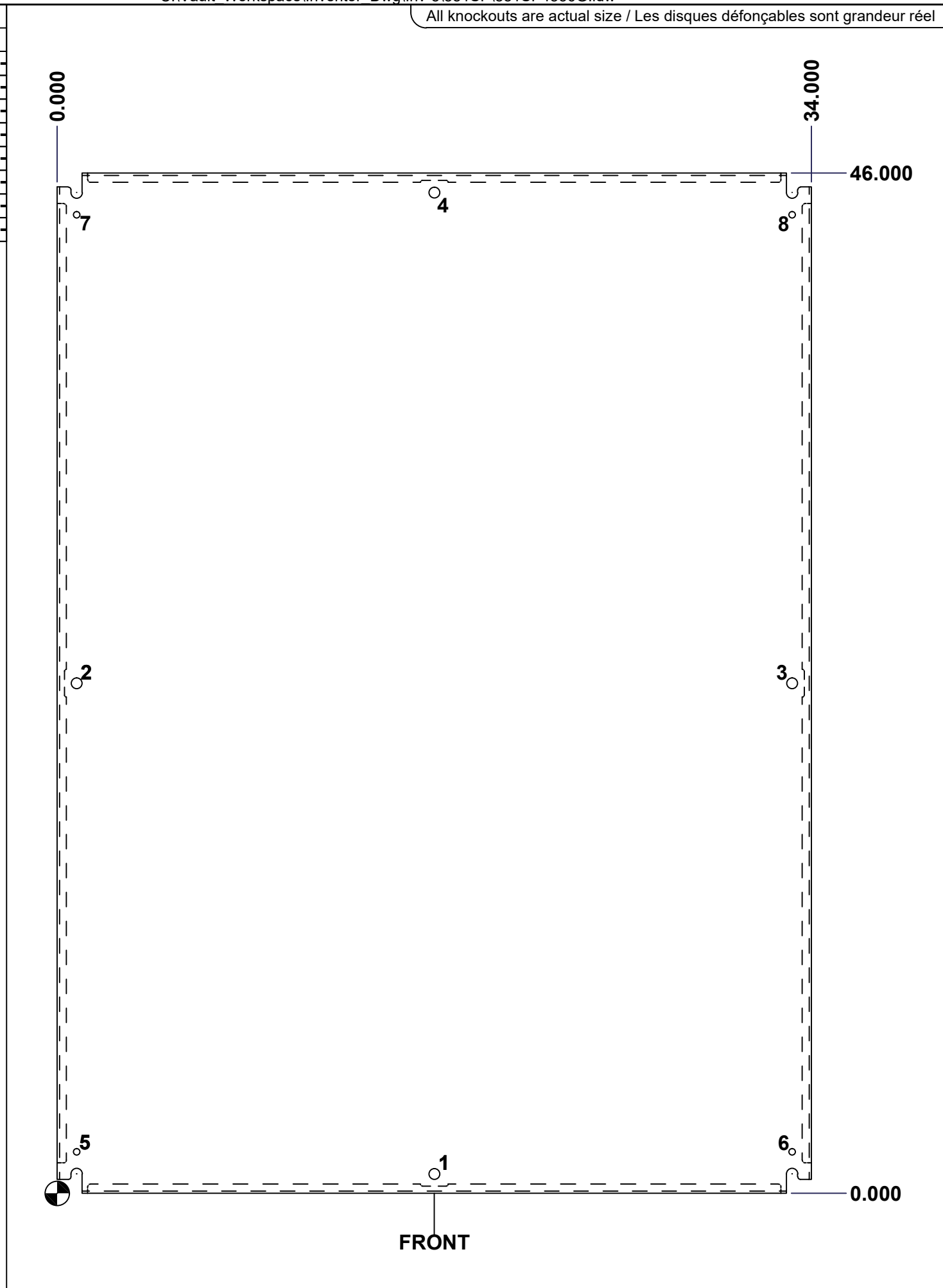

All knockouts are actual size / Les disques défonçables sont grandeur réel

No.	Revisions	Date	By/Par

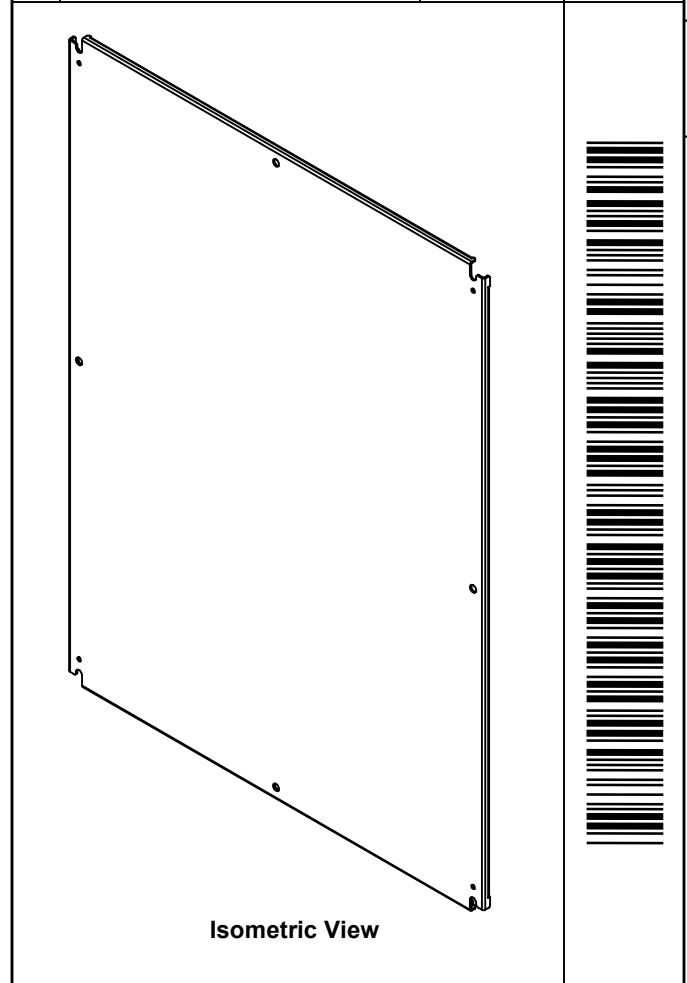

	Tél: (450) 979-4373 Fax: (450) 979-4626 www.exmweb.com	Flatness Aplatissement Max 3.0mm
	Projection 	Customer Client
Drawn By Dessiné Par BoxCad	Date 23-Jan-07	Material Matière See Part List
Color Couleur See Part List	Finish Fini See Part List	Description 881 SP - Inner Panel
Part Number Numéro Pièce 881 SP4836G	Detail Rev. 0	Rev. 2 2